

***Nikon***

**N2020**

**AF**

**INSTRUCTION MANUAL**

# CONTENTS

<b>FOREWORD</b> .....	3	<b>EXPOSURE</b> .....	28—32
<b>NOMENCLATURE</b> .....	4—8	PROGRAMMED EXPOSURE MODES .....	28
<b>BASIC OPERATION</b> .....	9—19	APERTURE-PRIORITY EXPOSURE MODE .....	29
MOUNTING THE LENS .....	9	MANUAL EXPOSURE MODE .....	30
INSTALLING BATTERIES AND CHECKING		FOR SPECIAL EXPOSURE SITUATIONS .....	31—32
POWER .....	10—11	AEL (Auto Exposure Lock) Button .....	31
LOADING FILM .....	12—14	Exposure Compensation Dial .....	32
BASIC SHOOTING .....	15—18	<b>FLASH PHOTOGRAPHY</b> .....	33—36
REWINDING FILM .....	18—19	PROGRAMMED TTL AUTO FLASH PHOTOGRAPHY	
<b>FOCUS</b> .....	20—27	IN P DUAL, P AND P HI MODES .....	34
AUTOFOCUS .....	20—23	TTL AUTOMATIC FLASH PHOTOGRAPHY .....	35
Continuous Servo Autofocus Mode .....	20—21	VIEWFINDER READY-LIGHT WARNINGS .....	36
Taking Pictures with An Off-Center		<b>SELF-TIMER</b> .....	36
Main Subject .....	22—23	<b>INTERCHANGEABLE FOCUSING SCREENS</b> .....	37
FOCUS-ASSIST OPERATION .....	24—25	<b>CAMERA CARE TIPS</b> .....	38—39
MANUAL FOCUS .....	26	<b>NOTES ON BATTERIES</b> .....	40
SPECIAL FOCUSING SITUATIONS .....	26—27	<b>SPECIFICATIONS</b> .....	41—44
AUTOFOCUS FLASH PHOTOGRAPHY .....	27	<b>LENSES</b> .....	45—47

## **FOREWORD**

Thank you for your kind patronage of Nikon. We hope the N2020 will make photography a much bigger part of your life.

Get to know your N2020, but before using it, be sure to read this manual well.

Nikon cannot be held responsible for malfunction resulting from the use of the camera other than as specified in this manual.

# NOMENCLATURE

## Focusing screen release latch

## Focusing screen type B

Interchangeable with type E or J; don't touch!

## AEL (auto exposure lock) button

Used to lock exposure value in automatic exposure mode. (See p.31.)

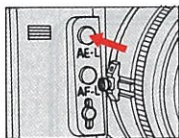

## AFL (autofocus lock) button

Used to lock focus in Continuous Servo Auto-focus mode. (See p.23.)

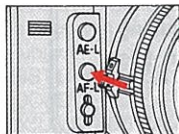

## Attaching index dots

## Bracket

## Battery chamber

## AAA battery holder MB-4

Remove to change batteries; interchangeable with Nikon AA Battery Holder MB-3 to allow use of AA-type batteries

## AF contacts

Keep clean, don't touch!

## Lens mounting index

## Lens release button

## Remote control terminal

Use Nikon Remote Cord MC-12A

## Lens mounting flange

## Bracket removing ribbon

## Battery holder screw

## Tripod socket

Optional Nikon Tripod Adapter AH-3 recommended

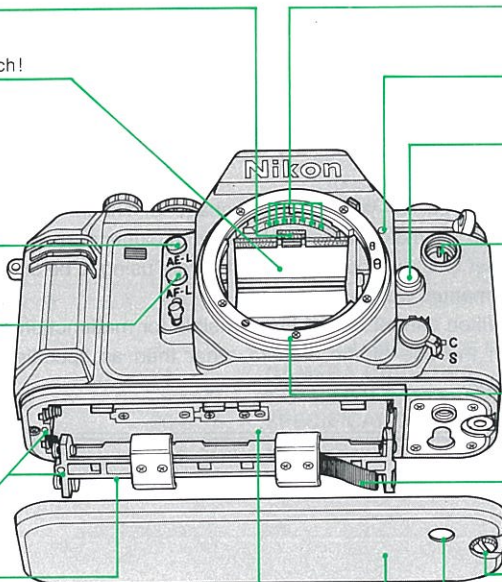

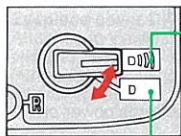

### Audible warning switch

Bleeps (1) when non-DX-coded film with film speed scale set at DX is used; (2) when DX contacts require cleaning; (3) to indicate over- or underexposure, or possible picture blur in auto exposure modes; (4) at end of film and (5) during self-timer operation

No sound

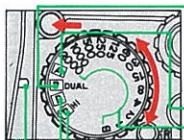

### Exposure mode selector dial

For P DUAL, P, P HI and A positions, push lock button  
Dual programmed auto exposure mode—camera automatically selects high-speed or normal program

Aperture-priority auto exposure mode  
Manual exposure mode; B is for time exposure  
High-speed programmed auto exposure mode  
Normal programmed auto exposure mode

Index

### Exposure mode selector dial lock release button

### Frame counter window

### Camera strap eyelet

### Self-timer lamp

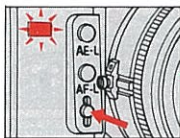

### Self-timer button

See p. 36.

### Accessory shoe

For electronic flash; see p. 33

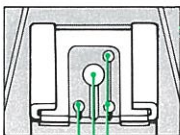

Electrical contacts

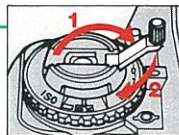

### Film rewind crank

Fold out to rewind film

### Camera strap eyelet

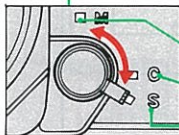

### Focus mode selector

For focus-assist operation/manual focus  
For Continuous Servo Autofocus  
For Single Servo Autofocus

### Reflex-mirror

Don't touch!

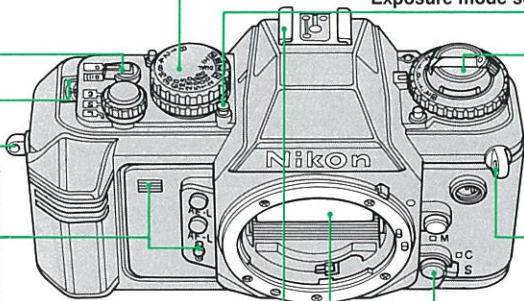

### Film speed ring/Exposure compensation dial

To set film speed, lift and turn; for exposure compensation, push lock release button and turn

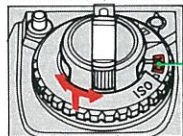

ISO film speed scale (DX setting for DX-coded film; 12 to 3200)

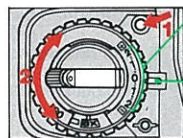

Exposure compensation settings (+2 to -2)

Index

### Exposure compensation dial lock release button

### Film cartridge window

### Film plane indicator

Exact distance between lens mounting flange and film plane is 46.5mm

### Red indicator lamp

Blinks (1) when non-DX-coded film with film speed scale set at DX is used, (2) when DX contacts require cleaning, (3) at end of film, and (4) when shutter is released

### Film advance mode selector/Fingerguard

To select film advance mode, lift and turn

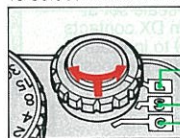

Locks shutter release/turns power off

For single-frame shooting  
For continuous shooting

### Shutter release button

To activate auto-focus function and exposure meter, lightly press to fingerguard position; to release shutter, depress fully

Fingerguard position

Fully depressed

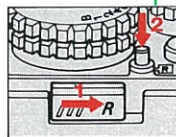

Film rewind lever  
Slide to right

Film rewind button  
Press while sliding lever

### Film advance indicator

Rotates to show film is properly loaded and being advanced

**Eyepiece cover DK-5**

Attaches to viewfinder eyepiece to keep out stray light during self-timer and remote control operation

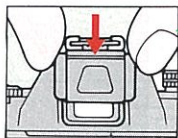

**Viewfinder eyepiece**

**Film rewind fork**

**Film cartridge chamber**

**DX contacts**

For automatic film speed setting with DX-coded film; keep clean; don't touch!

**Shutter curtains**

Don't touch!

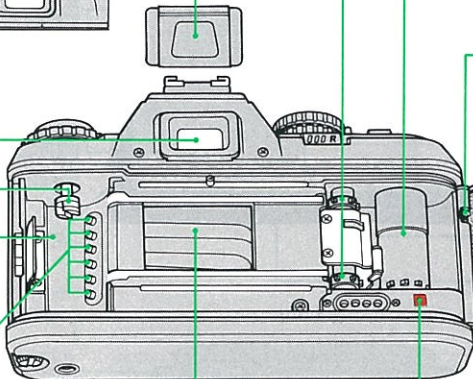

**Film sprocket**

**Film takeup spool**

**Camera back hinge release**

Push down to remove camera back

**Film pressure plate**

**Camera back**

Interchangeable with Nikon Multi Data Back MF-19

**Film leader index**

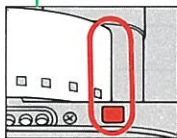

## Inside Viewfinder

### 12mm-dia. central area

Placing main subject in this area assures correct exposure

### Focus brackets

Center brackets on the main subject

### Focus indicator LEDs

In-focus indicator

Focus-not-possible warning

Focus-to-right arrow—for too distant subject

Focus-to-left arrow—for too near subject

Clear matte field

Exposure indicator LEDs

Overexposure warning

Shutter speed indicators

Underexposure warning

Flash ready-right

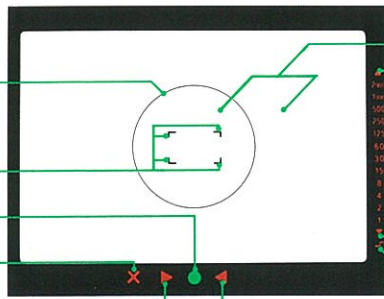

## Lens

### Focusing ring

Used for focus-assist operation/manual focus

### Infrared compensation index

### Depth-of-field indicators

### Aperture ring

### Meter coupling ridge

Aperture/distance index

Distance scale

Minimum aperture lock

Used in P DUAL, P, P HI exposure mode

Aperture scale

Aperture-direct-readout scale

Not used with N2020

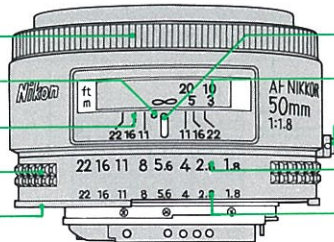



# BASIC OPERATION

## MOUNTING THE LENS

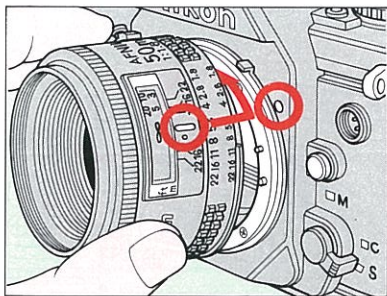

### 1. Mount lens.

Twist the lens counterclockwise until it clicks into place.  
Do not push the lens release button when mounting.

See p.45 for list of usable/  
unusable lenses.

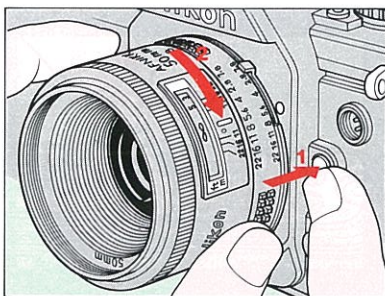

### To remove

Do not push the lens release button except when removing lens.

## INSTALLING BATTERIES AND CHECKING POWER

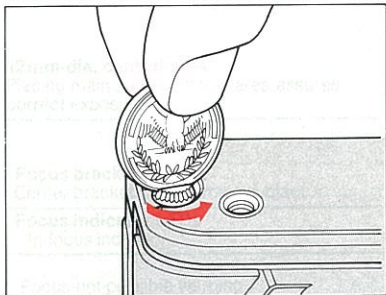

**2.** Remove AAA battery holder MB-4.

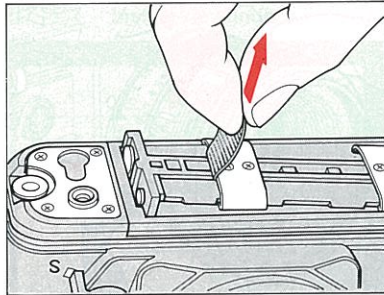

**3.** Remove bracket.

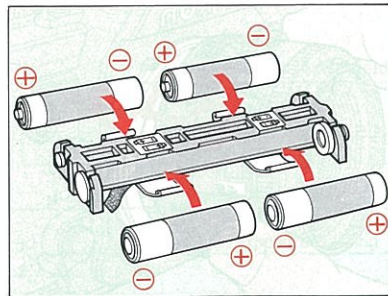

**4.** Install four AAA-type batteries.

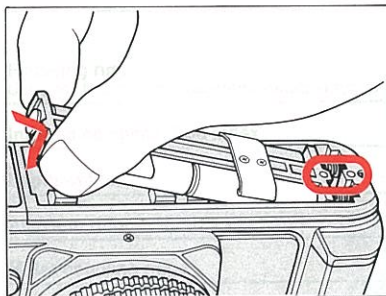

**5.** Align white dots and put back bracket.

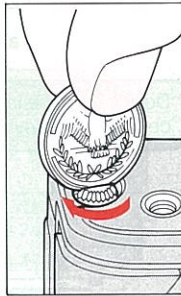
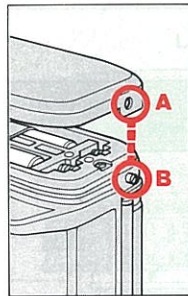

**6.** Line up hole "A" with post "B" and reattach battery holder.

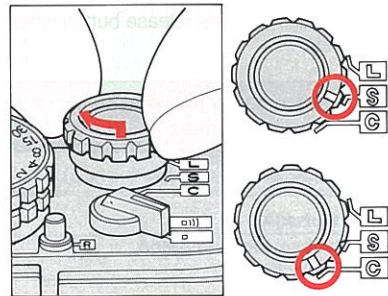

**7.** Set film advance mode selector.

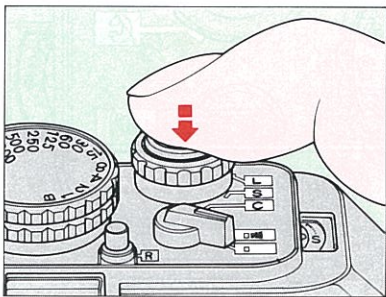

**8. Lightly press shutter release button to finger-guard position and check viewfinder exposure indicator LED(s) to make sure battery power is sufficient.**

Exposure indicator LED(s) lights up if power is sufficient, and stays on for 8 sec. after you take your finger off the button, unless you release the shutter. Upon shutter release, the exposure indicator LED(s) turn off 1 sec. after you remove your finger from the button.

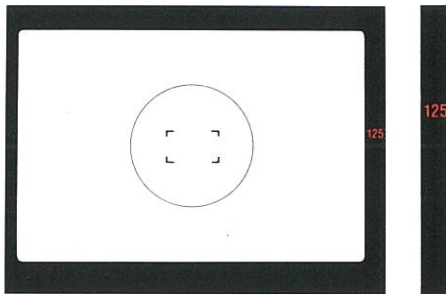

**Lit-up LED**  
Sufficient battery power

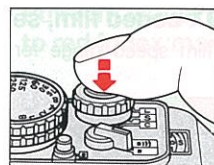
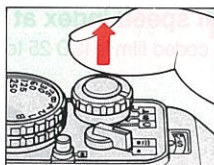
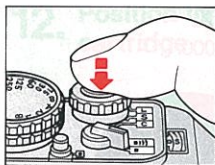

125



If LED goes off immediately after finger is removed from button, batteries need replacement.

**No LED**  
Change batteries, or re-install them properly.

## LOADING FILM

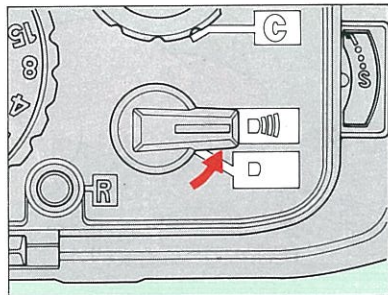
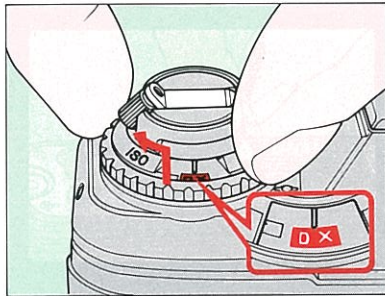
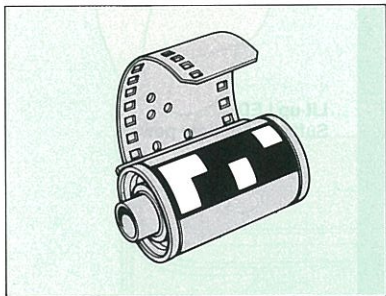

### 9. With DX-coded film, set film speed index at DX.

Usable film speed range for DX-coded film is ISO 25 to 5000.

### 10. Set audible warning lever to position.

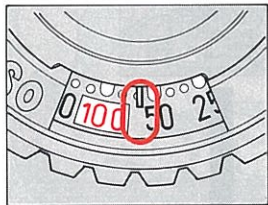

With non-DX-coded film, set to appropriate film speed.

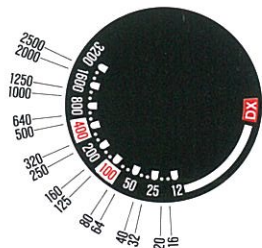

The two dots between numbers stand for intermediate settings.

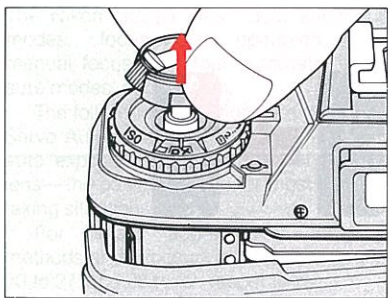

- 11. Open camera back.**  
Pull up film rewind knob until camera back springs open.

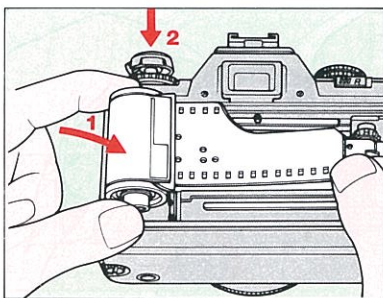

- 12. Position film cartridge.**

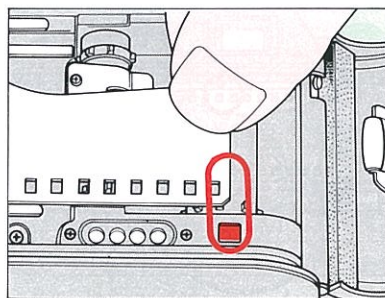

- 13. Pull film leader out to red index mark.**



Avoid loading or unloading film in direct sunlight.

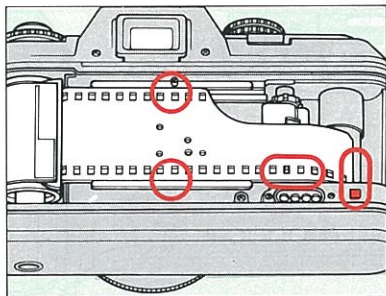

**14. Check film position and close camera back.**

The shutter curtains remain closed while the camera back is open to prevent damage.

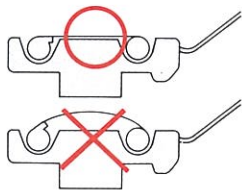

Pull out the film leader gently to avoid film slack.

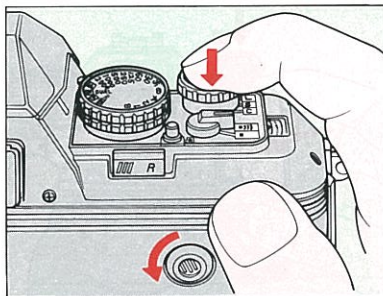

**15. Fully depress shutter release button to automatically advance film to frame "1."**

Make sure the film advance indicator rotates to show proper film installation.

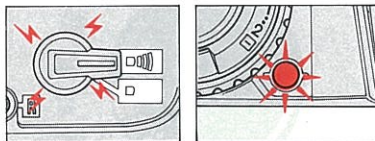
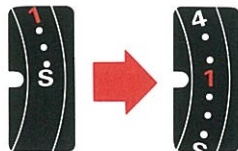

If audible warning bleeps and red indicator lamp blinks for 8 sec., check the following:  
 (1) Are you using DX-coded film? (For non-DX-coded film, see p. 12)  
 (2) Are the DX contacts clean? (See p. 38.)

## BASIC SHOOTING

The Nikon N2020 offers dual autofocus modes, focus-assist operation, and manual focus, plus four automatic exposure modes, and manual.

The following instructions are for Single Servo Autofocus shooting in the P DUAL auto exposure mode with an AF Nikkor lens—the easiest setting for most picture-taking situations.

For details about other focusing methods and exposure modes, see pages 20 to 27, and 28 to 32, respectively.

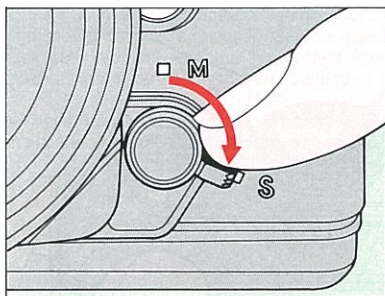

- 16.** Set focus mode selector to S for Single Servo Autofocus.

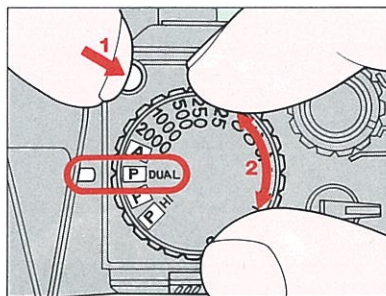

- 17.** Set shooting mode selector dial to P DUAL.

Turn dial while pressing lock button.

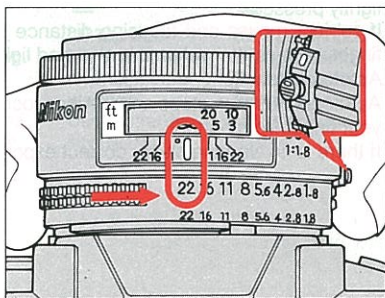

- 18.** Set lens to its minimum aperture (largest f-number).

With AF Nikkor lenses, lock lens aperture at minimum setting. (See the lens instruction manual).



- 19. Compose.** Center the focus brackets inside the viewfinder on the main subject.

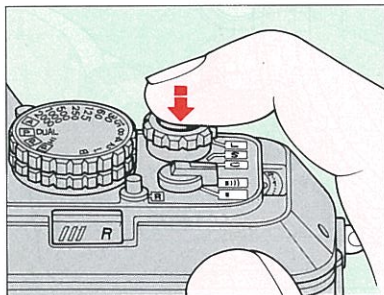

- 20. Lightly press shutter release button to fingerguard position.**

The N2020 automatically secures the correct subject focus. When the green in-focus indicator LED lights up, you can release the shutter. In S (Single Servo Autofocus) mode, shutter cannot be released until the green in-focus indicator LED lights up, and once it does light up, the focus is locked as long as the shutter release button remains lightly pressed.

If subject moves and focusing distance changes, refocus by briefly removing your finger from shutter release button and lightly pressing it again to restart Single Servo Autofocus function.

Autofocus function stops and the lens focusing ring position is fixed when you remove your finger from button.

If there is no warning bleep, correct exposure is assured.

Main subject is in focus .

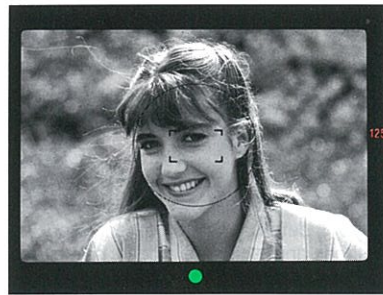



If in-focus indicator LED does not appear:



While **X** remains lit, autofocus is impossible with the subject and shutter cannot be released. Set focus mode selector to M and focus manually on clear matte field. (See p.26 to 27 for subjects which cannot be shot on autofocus.)



While **◀** remains lit, the subject is closer than the closest focusing distance of the lens in use. Move back from the subject.

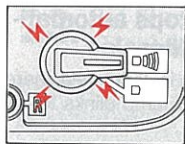

If you hear a warning beep, check exposure indicator LED for the following:



**(1) Picture blur possibility (1/30 sec. or slower)**

Use tripod to avoid camera shake, or use a Nikon speedlight to synchronize shutter speed at 1/125 sec.



**(2) Top LED triangle blinks—Overexposure warning**

Use neutral density (ND) filter.



**(3) Bottom LED triangle blinks—Underexposure warning**

Use electronic flash.

**Both top and bottom LED triangles blink—wrong-aperture-set warning**



Set lens to minimum aperture. There is no audible warning.

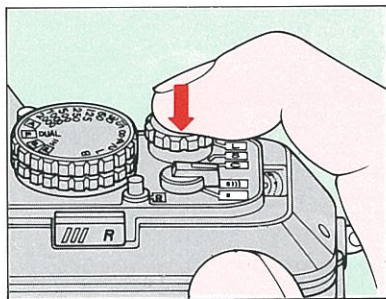

## 21. Fully depress shutter release button to take picture.

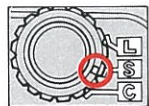

With film advance mode selector on S (single-frame shooting), fully depressing and releasing the shutter release button *auto-*matically advances film by one frame.

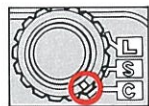

With film advance mode selector on C (continuous shooting), shots are continuously taken as long as shutter release is depressed.

In Single Servo Autofocus mode, when you remove your finger from the button after releasing the shutter, the focus indicator LED immediately disappears. The exposure meter and shutter speed LEDs stay on for 1 sec., however, then automatically turn off. To reactivate autofocus function and exposure meter, press shutter release button to fingerguard position again.

## REWINDING FILM

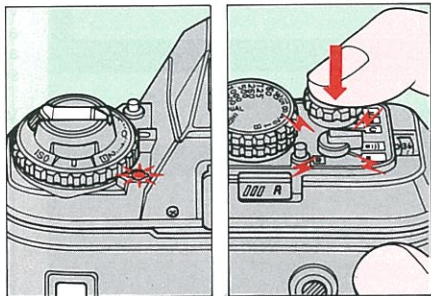

## 22. Film winding stops automatically at end of film.

When shutter release button is depressed, there is a bleep and red indicator lamp blinks to tell you to rewind film.

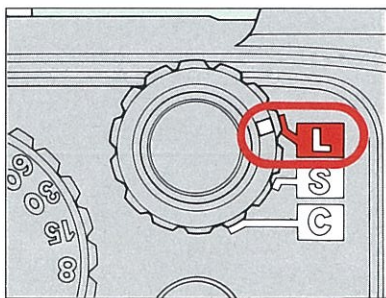

**23.** Set film advance mode selector to L.

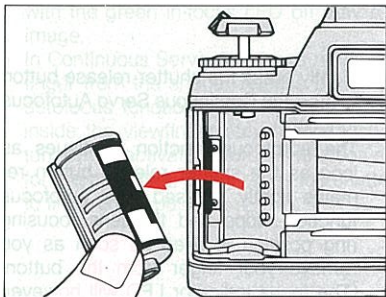

**26.** Remove film cartridge.

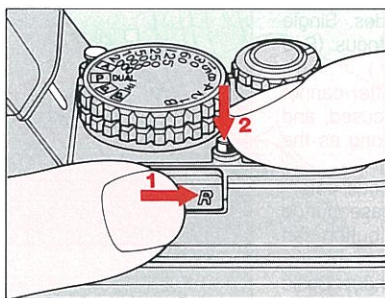

**24.** While sliding film rewind lever, push film rewind button.

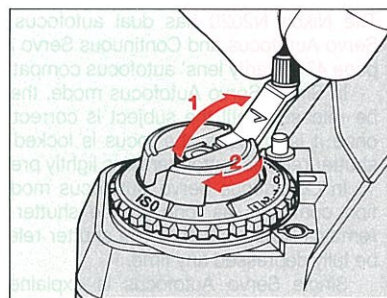

**25.** Rewind film.  
Fold out film rewind crank and rotate until film advance indicator stops moving.



# FOCUS

## AUTOFOCUS

The Nikon N2020 has dual autofocus modes. Single Servo Autofocus and Continuous Servo Autofocus. (See page 47 to verify lens' autofocus compatibility.)

In Single Servo Autofocus mode, the shutter cannot be released until the subject is correctly focused, and once it is in focus, the focus is locked as long as the shutter release button remains lightly pressed.

In Continuous Servo Autofocus mode, focus detection continues as long as the shutter release button remains lightly pressed. The shutter release button can be fully depressed any time.

Single Servo Autofocus is explained under Basic Operation (p. 15 to 18); the following instructions are for Continuous Servo Autofocus operation:

## Continuous Servo Autofocus Mode

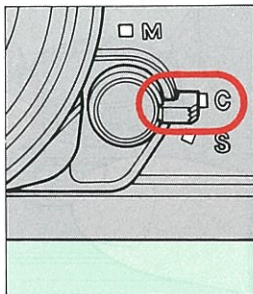

1. Set the focus mode selector to C for Continuous Servo Autofocus.



2. Center the viewfinder focus baskets on the main subject.

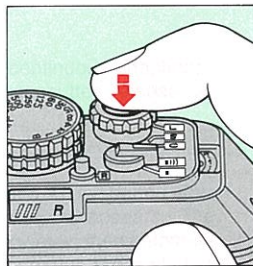

3. Lightly press the shutter release button to start the Continuous Servo Autofocus function.

The autofocus function continues as long as the shutter release button remains lightly pressed. The autofocus function stops and the lens focusing ring position is fixed as soon as you remove your finger from the button. (The focus indicator LED will however, remain on for 8 sec.)

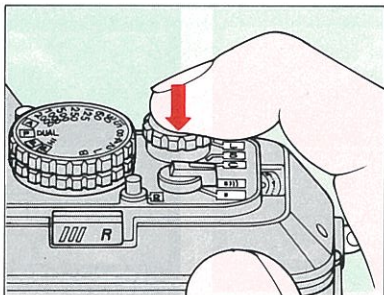

4. Confirm that the green in-focus indicator LED lights up, then fully depress the shutter release button to get a correctly focused image. Fully depressing the shutter release button with the green in-focus LED off may result in an out-of-focus image.

In Continuous Servo Autofocus mode, when you remove your finger from the shutter release button after depressing it, the autofocus function stops, but the exposure meter and LEDs inside the viewfinder stay on for 1 sec.—then automatically turn off. To activate autofocus function and the exposure meter for the next shot, lightly press the shutter release button again to fingerguard position.

If in-focus indicator LED does not appear, see below.



A lit **X** means autofocus is impossible with the subject. You should then set the focus mode selector to M and focus manually on the clear matte field. (See p.26 to 27 for subjects which cannot be used with autofocus.)



A lit **◀** means the subject is closer than the closest focusing distance of the lens. Move back from the subject.

## Taking Pictures with an Off-Center Main Subject Single Servo Autofocus mode



1. Center the focus brackets on the subject and lightly press the shutter release button.



2. Confirm that the in-focus indicator LED lights up.



3. Keeping the shutter release button lightly pressed, recompose, then fully depress the shutter release button.

## Continuous Servo Autofocus mode

Use the AFL (autofocus lock) button to lock focus on the desired subject.

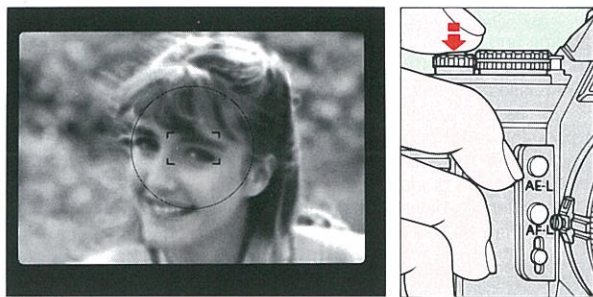

1. Center the focus brackets on the subject and lightly press the shutter release button.

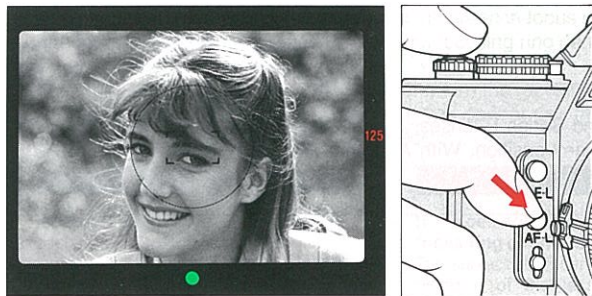

2. Keeping the shutter release button lightly pressed, confirm that the in-focus indicator LED lights up, then depress the AFL button and hold it in.

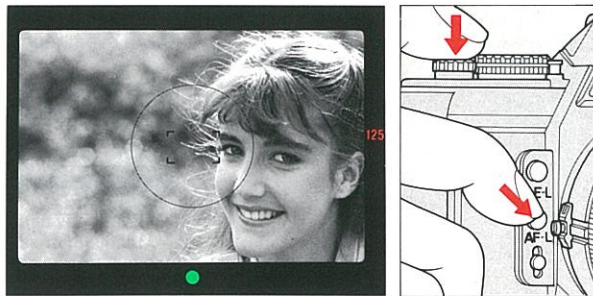

3. With the AFL button depressed, recompose as desired and fully depress the shutter release button.

## FOCUS-ASSIST OPERATION

Focus-assist operation is possible with Nikkor and Series E lenses with a maximum aperture of  $f/4.5$  or faster, including all AF Nikkor lenses.\*

In focus assist-operation, manually rotate the lens focusing ring while referring to the focus indicator LEDs in the viewfinder as a guide.

With lenses having maximum aperture slower than  $f/4.5$ , although the focus indicator LEDs appear, **they are not reliable**. Focus on clear matte field.

\*With some lenses, depending on focus distance, focus-assist operation cannot be used. For details, see page 47.

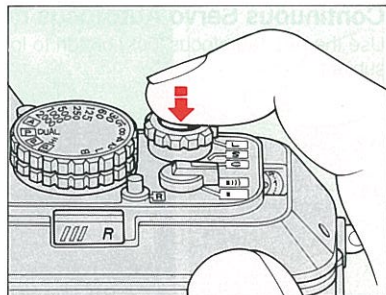
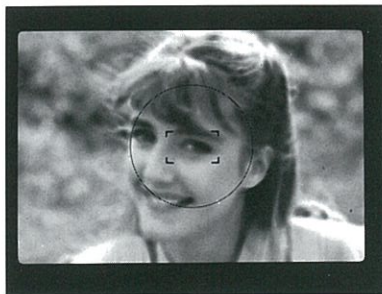

1. Look inside the viewfinder and center the focus brackets on the main subject.

2. Lightly press the shutter release button.

With Nikkor and Series E lenses, the camera's focus mode selector can be set to any position. With AF Nikkor lenses, however, set the focus mode selector to **M**.



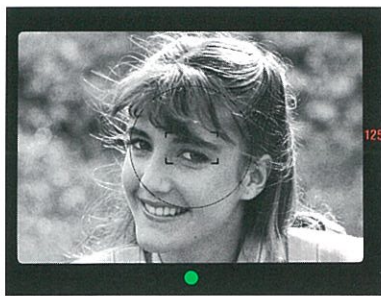
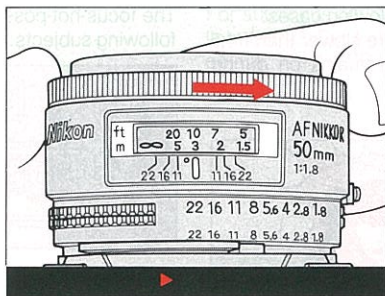
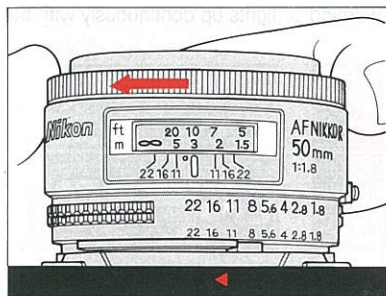

3. Keeping the shutter release button lightly pressed, watch the focus indicator LED inside the viewfinder.

If the focus-to-left arrow ◀ or focus-to-right arrow ▶ appears, manually rotate the lens focusing ring in the direction indicated until the green in-focus LED appears.

If the focus-to-left arrow appears but the lens focusing ring can no longer move to the left, move back from the subject.

If the focus-not-possible indicator × appears, turn the focusing ring in either direction until it disappears; if it does not disappear, you cannot use the focus-assist feature. Use the clear matte field to focus the subject.

4. Confirm that the in-focus indicator LED is visible, then fully depress the shutter release button.



**If × does not disappear:**

The focus-assist feature cannot be used with the subject. Use the clear matte field for focusing. (See p.26 to 27 for subjects which cannot be used with focus-assist operation.)



**If ◀ does not disappear when you turn the focus ring counterclockwise to the limit:**

The subject is closer than the closest focusing distance of the lens. Move back from the subject.

## MANUAL FOCUS

Use the clear matte field for focusing in the following cases:

- 1) When using lenses with a maximum aperture slower than f/4.5
- 2) When the focus-not-possible warning  $\times$  remains on during autofocus or focus-assist operation
- 3) When shooting any of the following—

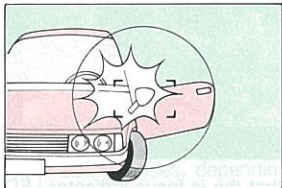

- **Subject with high reflectivity**

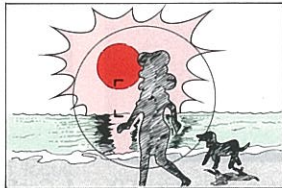

- **Backlit subject**



- **Scene with subjects located at different distances**

With AF Nikkor lenses, set the focus mode selector to **M** for manual focus.

## SPECIAL FOCUSING SITUATIONS

The focus-not-possible warning  $\times$  lights up continuously with the following subjects:



### 1) Dark subject

In this case, focus manually, or secure focus on another subject that lies at the same distance for autofocus or focus-assist operation.

You can also perform autofocus with the Nikon Autofocus Speedlight SB-20. (No other flash unit can be used.)

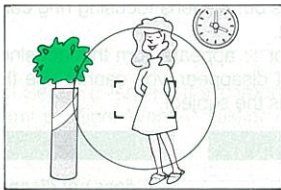

### 2) Low-contrast subject

Focus manually, or focus on another subject lying at the same distance until the green in-focus indicator LED appears in autofocus or focus-assist operation.

## AUTOFOCUS FLASH PHOTOGRAPHY

For autofocus operation in darkness, use Nikon Autofocus Speedlight SB-20. Set the N2020 to Single Servo Autofocus mode. For details, see the SB-20's instruction manual.

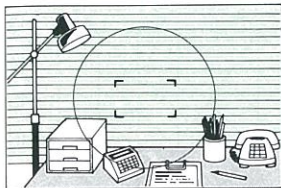

### 3) Subject with no vertical lines

Turn the camera sideways to focus, or focus manually. You may also focus on another subject with vertical lines lying at the same distance for autofocus or focus-assist operation.



### 4) Small or finely detailed subject

Use manual focusing, or focus on another, larger subject lying at the same distance for autofocus or focus-assist operation.

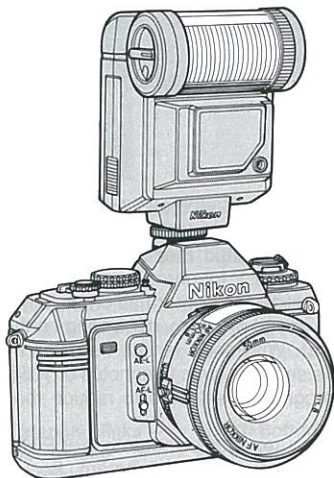

# EXPOSURE

## PROGRAMMED EXPOSURE MODES

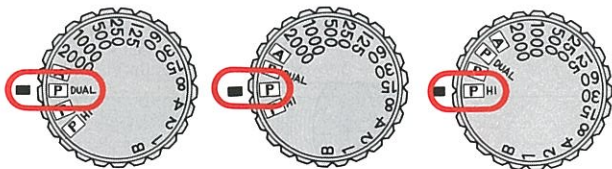

The N2020 microcomputer automatically sets the optimum combination of shutter speed and lens aperture. The N2020 offers three programmed automatic modes—dual, normal and high-speed—P DUAL for dual, P for normal, and P HI for high-speed.

In the P DUAL mode, the camera automatically selects either the normal or high-speed program, depending on the focal length of the lens in use\*. With short lenses (less than 135mm), the normal program is selected; with telephotos of 135mm or longer, the high-speed program is selected to reduce the possibility of blur.

Setting the exposure mode selector to P or P HI allows you to choose the normal or high-speed program. For a high shutter speed, such as when using a telephoto lens or for shooting a fast-moving subject, P HI is recommended. (See p. 15 to 18 for operation of programmed automatic exposure.)

\*With AI-S type lenses only; with other lenses, normal program is selected. For information on how to recognize AI-S type lenses, see p.45.

Dual program chart (50mm f/1.4, ISO 100)

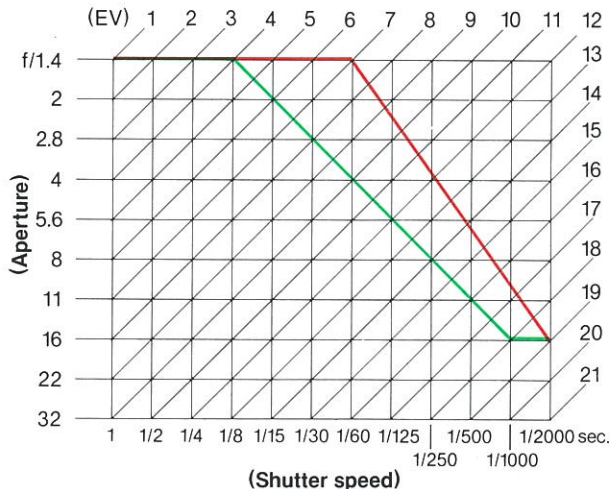

The EV (exposure value) chart demonstrates the difference between the N2020's normal and high-speed programs. Follow either colored line to where it intersects a diagonal line. This shows the combination of aperture (vertical line) and shutter speed (horizontal line). For example, at a brightness of EV12, the N2020 selects f/4 and 1/250 sec. at P HI; f/5.6 and 1/125 sec. at P (with 50mm f/1.4 lens at ISO 100).

## APERTURE-PRIORITY EXPOSURE MODE

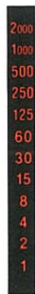
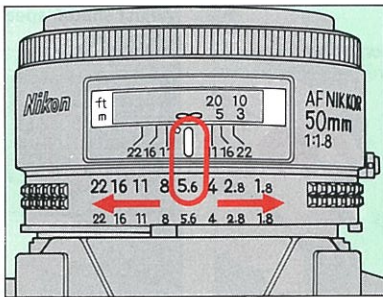
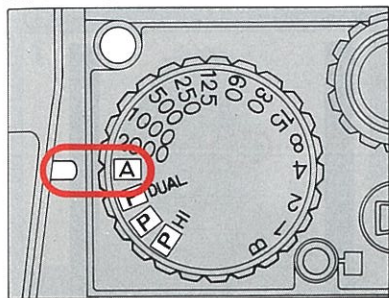

Correct exposure is assured.

250  
125

Two LEDs show intermediate shutter speed.

At A, the N2020's microcomputer automatically selects the correct shutter speed to match the aperture you set. This is the recommended mode when depth of field is your prime consideration. If you want to blur the background in portraiture, for instance, use wider apertures (i.e., smaller f-numbers like f/1.8 or f/2). To make everything come out sharp in scenic photography, use smaller apertures (i.e., larger f-numbers like f/16 or f/22).

1. Set shooting mode selector to A.
2. Set lens to desired f-number (engraved on aperture scale).
3. Look inside viewfinder and lightly press shutter release button.

The LED shows the shutter speed selected by the camera for correct exposure with the aperture you set. If there is no warning beep, you can take the picture by fully depressing the release button.

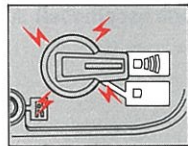

If there is a warning beep, check the viewfinder exposure indicator LED for the following:

- 125  
60  
30  
15  
8  
4  
2  
1
- (1) **Picture blur possibility (1/30 sec. or slower)**  
Use a tripod to avoid camera shake, or use a Nikon speedlight to synchronize shutter speed at 1/125 sec.



- (2) **Top LED triangle blinks—Overexposure warning**  
Stop the lens down until the LED stops blinking, or use a neutral density (ND) filter.



- (3) **Bottom LED triangle blinks—Underexposure warning**  
Select a wider aperture or, if necessary, use a Nikon speedlight.

## MANUAL EXPOSURE MODE

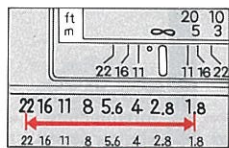

500 Shutter speed for correct exposure

125 Shutter speed set on dial



Adjust shutter speed and/or aperture

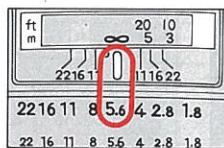

125



500

In the manual exposure mode (1/2000~1 sec., plus B), both shutter speed and aperture can be set manually according to the effect desired. Use fast shutter speeds to stop action, slower speeds to produce a deliberate blur. The manual exposure mode also allows depth of field control.

1. Set shutter speed and aperture.
2. With your eye on the viewfinder, lightly press the shutter release button.

The non-blinking LED shows the shutter speed set on the dial. A blinking LED indicates the shutter speed for correct exposure; when two blinking LEDs blink, the correct shutter speed is intermediate.

Reset aperture and/or shutter speed until only one LED is shown.

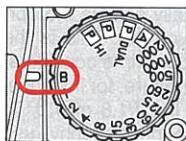

On B, the shutter curtains remain open as long as the shutter release button is depressed and, although no exposure indicator LED appears inside the viewfinder, the camera meter is on.

## FOR SPECIAL EXPOSURE SITUATIONS

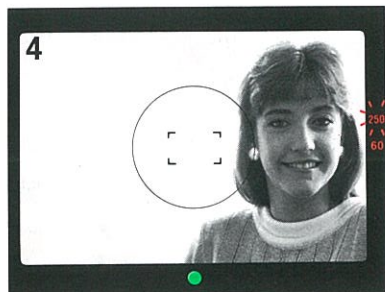
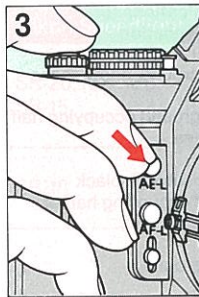
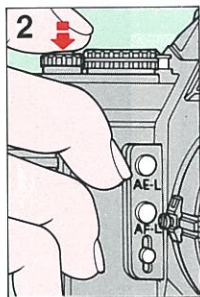

(In A mode)

### AEL (Auto Exposure Lock) Button

In the P DUAL, P, P HI or A mode, to shoot a subject outside the 12mm-dia. circle or when there is substantial brightness contrast between the main subject and the background (e.g., a strongly backlit subject), use the AEL button.

1. Center main subject inside viewfinder or move in closer.
2. Lightly press shutter release button.
3. While lightly pressing the shutter release button, depress AEL button and hold it in.
4. Recompose and shoot.

In the A mode, the shutter speed LED blinks\* while you are recomposing. However, the shutter operates at the speed indicated by the **lit-up shutter speed LED** (1/60 sec. in the example). In the P DUAL, P and P HI modes, only the lit-up shutter speed LED is shown.

\* In photo No. 4, the blinking 250 LED indicates the shutter speed for the background; the lit-up 60 indicates the shutter speed for the girl's face.

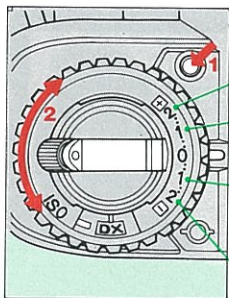

### Suggested applications for exposure compensation

- +2 White background, snow scene
- +1 White background occupying half of viewed area
- 1 Spotlighted subject, black background occupying half of viewed area
- 2 Black background

## Exposure Compensation Dial

For unusual lighting situations—snowscapes, backlit subjects, or when the main subject contrasts sharply with the background—use the exposure compensation dial to prevent over- or under-exposure. -1 and -2 indicate one and two stops less exposure, respectively; +1 and +2 indicate one and two stops additional exposure, respectively.

1. Press the lock button.
2. While pressing the lock button, rotate the dial to set the desired compensation value.
3. After use, reset the dial to 0.

When the film speed ring is set at DX with ISO 5000 DX-coded film, only  $-1\frac{1}{3}$  to +2 compensation is possible. With film speed ring set at ISO 1600, the exposure compensation dial can only be rotated between -1 and +2; at ISO 3200, the dial cannot be rotated in the - direction. With film speed ring set at ISO 25 or 12, though the exposure compensation dial can be rotated from -2 to +2, only -2 to +1 compensation is possible at ISO 25; at ISO 12, only minus compensation is possible.



Without compensation

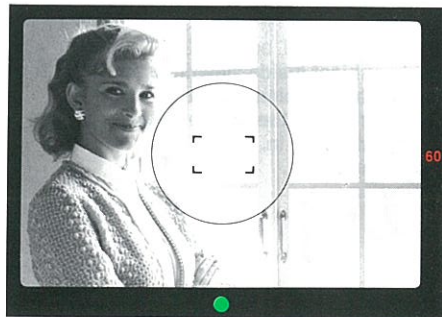

+2EV compensation



# FLASH PHOTOGRAPHY

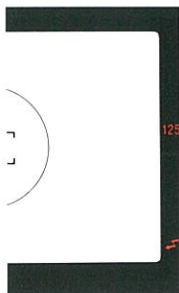
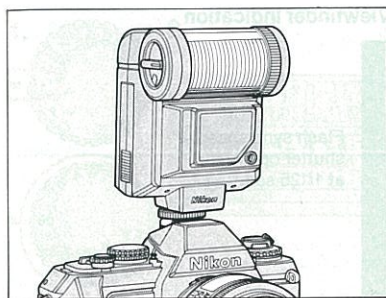

The N2020 accessory shoe allows direct mounting of Nikon dedicated electronic flash units, including Nikon Autofocus Speedlight SB-20. The SB-20 enables you to perform Single Servo Autofocus operation even in darkness.

When the N2020 is set at A, P DUAL, P, P HI, or a manual setting of 1/250 sec. or higher, the shutter speed automatically switches to 1/125 sec. for proper flash synchronization. When the N2020 is set at a manual setting of 1/125 sec. or slower, the shutter operates at the speed set on the dial.

Ready-light indication in the viewfinder is also provided with Nikon dedicated flash units. With the camera's meter on, a thunderbolt-mark LED ready-light comes on to indicate the flash is ready to fire. Warning indications are provided by a blinking ready-light. Conditions represented by the warning vary between flash unit models. For details, see your flash unit instruction manual.

Use Nikon Speedlights only. Other units may damage the camera's electrical circuit.

Nikon Speedlight	Connection	Usable Flash Mode
SB-20*/SB-16B/ SB-15	Direct	Programmed TTL auto**, TTL auto, non-TTL auto, manual
SB-18	Direct	Programmed TTL auto**, TTL auto, manual
SB-14/SB-11	Via TTL Remote Cord SC-23	Programmed TTL auto**, TTL auto, manual
	Via Sensor Remote Cord SC-13	Non-TTL auto, manual
SB-17/SB-16A	Via Flash Unit Coupler AS-6	Non-TTL auto, manual

\* Autofocus flash photography possible.

\*\* Programmed TTL auto flash photography can only be performed with **AI-S type Nikkor and Series E** lenses.

**The following instructions are for programmed TTL auto and TTL auto flash shooting only.** For non-TTL auto and manual flash shooting, see your flash unit instruction manual.

Note that the film speed range for programmed TTL auto and TTL auto flash photography is ISO 25 to 1000.

## PROGRAMMED TTL AUTO FLASH PHOTOGRAPHY IN P DUAL, P AND P HI MODES

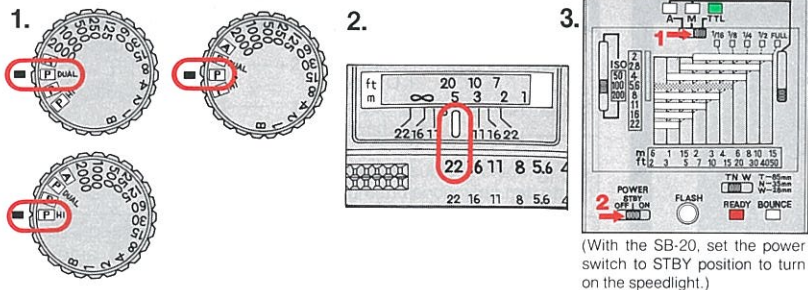

### Viewfinder indication

125

Flash sync speed—shutter operates at 1/125 sec.

In programmed TTL auto flash photography, the camera selects the appropriate aperture. Note that only **AI-S type** lenses can be used.

Set the N2020 to P DUAL, P or P HI (illust. 1), and set the lens to its minimum aperture (largest f/number) (illust. 2). Set the speedlight's mode selector to TTL, and turn the speedlight on (illust. 3). Look inside the viewfinder and lightly press the shutter release button. With the ready-light on, as long as you have none of the following warning indications, you can shoot.

For Single Servo Autofocus with the SB-20's AF illuminator in programmed TTL auto flash operation, use high-sensitivity film for greater depth of field. (For details, see the SB-20's instruction manual.)

### Warning indication



If either of the triangle-shaped top and bottom LEDs blinks, confirm that the lens is an **AI-S** type, or reset the AI-S lens to its minimum aperture.

# TTL AUTOMATIC FLASH PHOTOGRAPHY

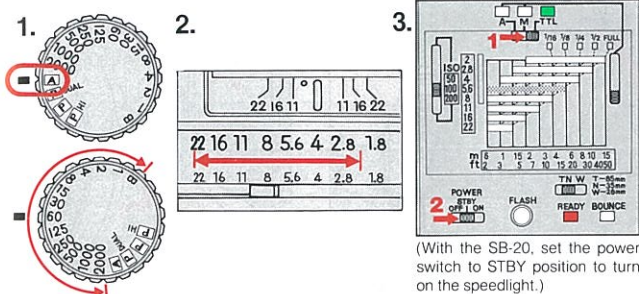

(With the SB-20, set the power switch to STBY position to turn on the speedlight.)

## Viewfinder indication

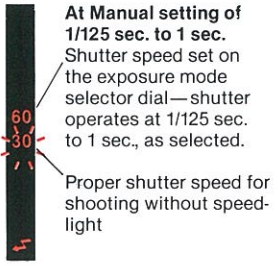
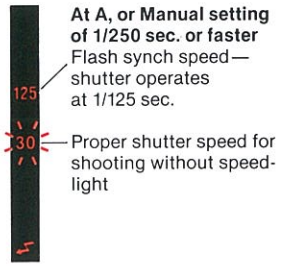

Select appropriate aperture. Set the N2020 to A or one of the manual settings (illustr. 1). Determine aperture using the speedlight exposure calculator dial\* (illustr. 2). (See flash unit instruction manual for details.) Set the speedlight mode selector to TTL and turn the speedlight on (illustr. 3). Look inside the viewfinder and lightly press the shutter release button. When the ready-light comes on, you can shoot.

\* For Single Servo Autofocus operation assisted by the SB-20's AF illuminator, set the lens aperture as follows for greater depth of field:

	Lens maximum aperture	Aperture setting
Lens only	f/2.8 or faster	f/2.8 or larger f-number (f/2.8, f/4, f/5.6, etc.)
	Slower than f/2.8	f/5.6 or larger f-number (f/5.6, f/8, f/11, etc.)
With TC-16A	f/1.4 or f/1.2	f/2 or larger f-number (f/2, f/2.8, f/4, etc.)
	f/1.8, f/2, f/2.5 or f/2.8	f/4 or larger f-number (f/4, f/5.6, f/8, etc.)



## VIEWFINDER READY-LIGHT WARNINGS



In both programmed TTL auto and TTL auto flash photography, the viewfinder ready-light blinks to warn of improper film speed, poor connection between camera and speedlight, or underexposure possibility.

To prevent the viewfinder ready-light from blinking—

- 1) Use film with an ISO range of ISO 25 to 1000.
- 2) Keep speedlight and camera electrical connections clean.
- 3) Make sure the subject is within the **automatic shooting range\*** and, if necessary, set lens to a wider aperture.

\* See flash unit's instruction manual.

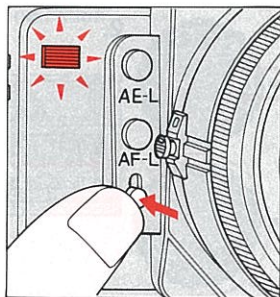
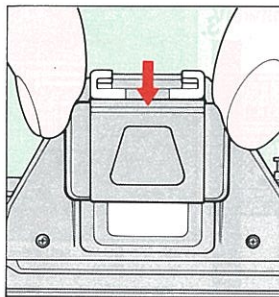

In the P DUAL, P, P HI or A mode, use the eyepiece cover DK-5 to prevent stray light from entering the viewfinder.

Set the audible warning switch at the  position. Press the self-timer button. The self-timer lamp will blink and a bleep will sound for 10 sec. before the shutter is released. During the final two seconds, the warnings will speed up, telling you to get ready. If you want to cancel the self-timer after activating it, press the button a second time.

In self-timer operation, the shutter is released whether or not the subject is in focus. To assure a focused image, focus the subject before pressing the self-timer button.

Regardless of the film advance mode selector setting, only single-frame shooting is possible.

# INTERCHANGEABLE FOCUSING SCREENS

The Type B screen provided with the N2020 can be interchanged with optional focusing screens Type J and E.

Be sure not to touch the focusing screen or reflex mirror with your fingers.

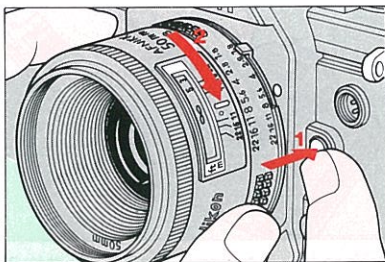

1. Remove the lens.

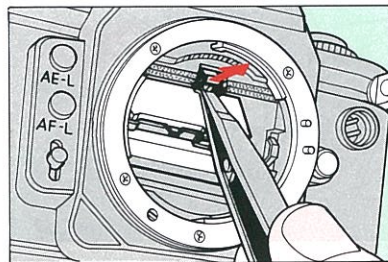

2. Slip the tip of the special tweezers (provided with optional screens) under the focusing screen release latch and pull outward to spring open the holder.

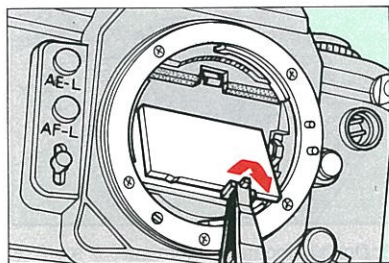

3. Remove the screen by grasping the small tab with the tweezers.

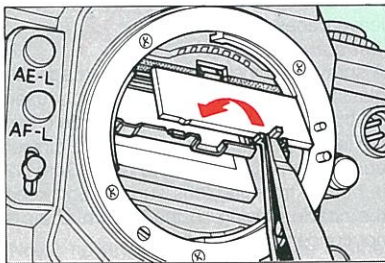

4. Carefully position the replacement screen in place, making sure the flash side is facing down.

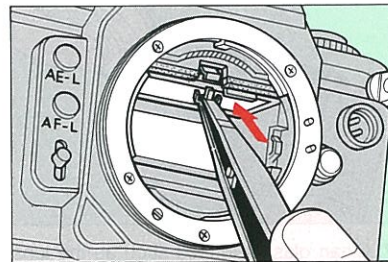

5. Using the tweezers, push the front edge of the holder upward until it *clicks* into place. An improperly placed focusing screen causes unreliable focus information in the viewfinder.

# CAMERA CARE TIPS



1. Never touch the reflex mirror and focusing screen. Remove dust with a blower brush.

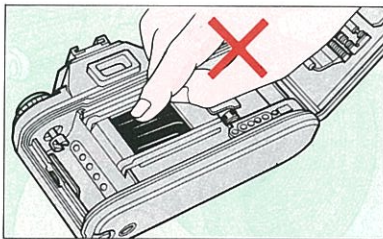

2. Never touch the shutter curtains.

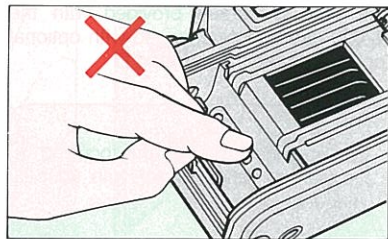

3. Never touch the DX-contacts. Keep clean with blower brush.

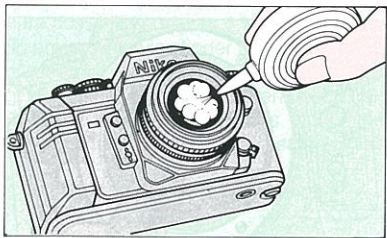

7. Clean glass surfaces such as the lens or the viewfinder eyepiece with a blower brush; avoid using lens tissue as much as possible. Wipe dirt and smudges, using soft cotton moistened with pure alcohol, in a spiral motion

from center to periphery. Be careful not to leave traces.

### Caution

A spray gun-type blower may damage the glass (especially when ED glass is used for the front lens element) if used to clean the lens. To avoid damage, hold the blower upright with its nozzle more than 30cm (12 in.) away from the lens surface and keep the nozzle moving so the stream of air is not concentrated in one spot.

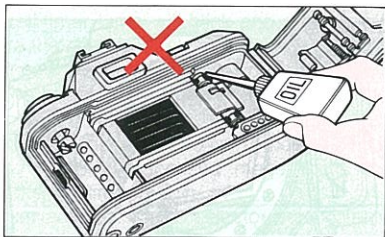

8. Don't lubricate the camera.

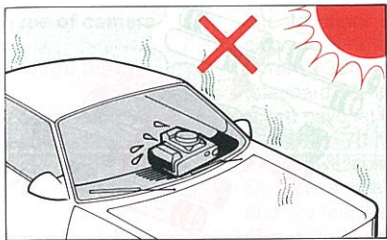

4. Don't leave the camera in an excessively hot place.

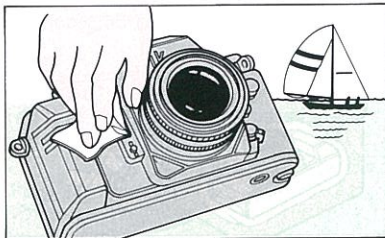

5. If the camera is exposed to rain or mist, or after shooting near the sea, wipe with a clean, soft cloth.



6. If the camera malfunctions, take it immediately to an authorized Nikon dealer or service center.

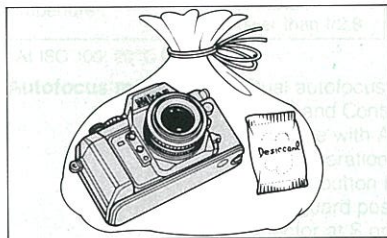

9. Store the camera in a cool, dry place away from naphthalene or camphor (moth repellents). In a humid environment, store the camera inside a vinyl bag with a desiccant to keep out dust, moisture and salt.



Note, however, that storing the leather case in a vinyl bag may cause the leather to deteriorate.

# NOTES ON BATTERIES

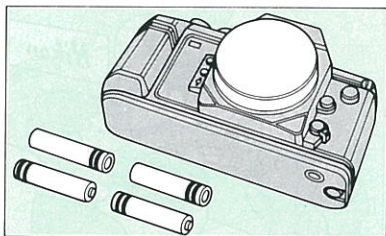

1. When not using the camera for a long period, remove batteries.



2. Battery power falls off in extremely cold temperatures—make sure you're using new batteries and keep the camera battery wrapped in something warm.

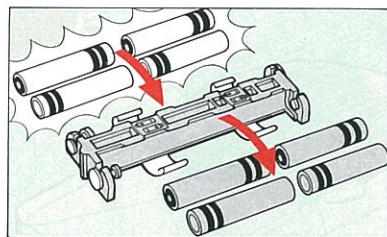

3. When replacing batteries, be sure to replace all batteries at the same time. Always use fresh batteries of the same brand.

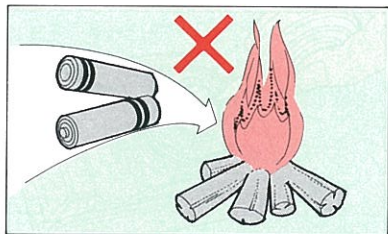

4. Don't throw used batteries into a fire.

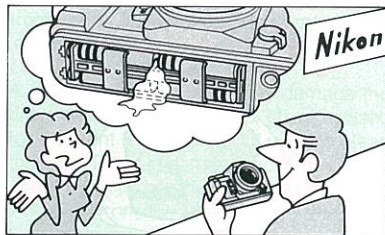

5. If the battery chamber is contaminated by battery leakage, take the camera to an authorized Nikon dealer.



# SPECIFICATIONS

<b>Type of camera</b>	Integral-motor dual autofocus 35mm single-lens reflex
<b>Picture format</b>	24mm × 36mm (standard 35mm film format)
<b>Lens mount</b>	Nikon bayonet mount
<b>Lens</b>	More than 70 Nikkor and Series E lenses available
<b>Focus modes</b>	Dual autofocus modes (Single Servo and Continuous Servo), focus-assist, plus manual focusing
<b>Focus detection system</b>	TTL phase detection system using 96 CCDs

## Autofocus detection range\*

Lens maximum aperture	f/2.8 or faster	Approx. EV4 to EV17
	f/4.5 or faster, but slower than f/2.8	Approx. EV5 to EV18

\* At ISO 100, 20°C (68°F)

<b>Autofocus modes</b>	Dual autofocus modes—Single Servo (at S) and Continuous Servo (at C)—available with AF Nikkor lenses; autofocus operation begins when shutter release button is lightly pressed to fingerguard position with focus mode selector at S or C
<b>Single Servo Autofocus</b>	Shutter release is not possible until in-focus indicator LED appears; once focused, focus is locked as long as shutter release button remains lightly pressed
<b>Continuous Servo Autofocus</b>	Focus detection continues as long as shutter release button is lightly pressed; shutter can be released

<b>Autofocus lock</b>	whenever desired even if in-focus indicators LED is not on
<b>Focus-assist</b>	Used in Continuous Servo Autofocus mode; holding button in locks focus
<b>Exposure metering</b>	Available on manual focus mode with an AF Nikkor, Nikkor or Series E lens with a maximum aperture of f/4.5 or faster; lens focusing ring is manually rotated in the direction of LED arrow inside viewfinder
<b>Exposure meter switch</b>	Light intensity feedback measurement (for P DUAL, P, P HI and A), TTL full-aperture centreweighted exposure measurement (for manual exposure); employs one silicon photo diode (SPD)
<b>Exposure meter switch</b>	Activated by setting film advance mode selector at S or C and lightly pressing shutter release button; stays on for approx. 8 sec. after lifting finger from button
<b>Metering range</b>	EV1 to EV19 at ISO 100 with f/1.4 lens
<b>Exposure control</b>	Three Program (dual, normal and high-speed) auto exposure modes, plus A (aperture-priority) auto exposure mode and manual exposure mode
<b>Program mode exposure control</b>	Choose from dual, normal or high-speed programs; both shutter speed and aperture are set automatically
<b>A (aperture-priority) mode exposure control</b>	Shutter speed automatically set to match manually set aperture
<b>Manual mode exposure control</b>	Both aperture and shutter speed are set manually

<b>Shutter</b>	Electronically controlled vertical-travel focal-plane shutter	camera; top warning LED blinks for overexposure, bottom warning LED indicates underexposure; top and bottom LEDs blink to indicate incorrect aperture setting
<b>Shutter release</b>	Electromagnetic	<b>A mode:</b> LED shows shutter speed automatically selected by camera; top or bottom warning LED blinks to indicate over- or underexposure
<b>Shutter speeds</b>	Stepless speeds from 1 to 1/2000 sec. on P DUAL, P, P HI and A auto exposure modes; lithium niobate oscillator-controlled discrete speeds from 1/2000 to 1 sec. on manual; electronically controlled long exposure at B setting	<b>M mode:</b> Non-blinking LED shows shutter speed set on dial; blinking LED shows shutter speed for correct exposure; two blinking LEDs show intermediate shutter speed; no LED at B (bulb)
<b>Viewfinder</b>	Fixed eyelevel pantaprism type; 0.85× magnification with 50mm lens set at infinity; approx. 92% frame coverage	<b>Auto exposure lock</b>
<b>Eyepiece cover</b>	Model DK-5; prevents stray light from entering viewfinder	Operates in P DUAL, P, P HI and A exposure modes; holding button in locks exposure
<b>Focusing screen</b>	Nikon Type B clear matte screen with central focus brackets for autofocus operation; 12mm-dia. reference circle denotes centerweighted metering area; changeable with optional Nikon Focusing Screen Type E or J	<b>Exposure compensation</b>
<b>Viewfinder information</b>	Focus indicator LEDs include focus-not-possible warning, in-focus indicator, focus-to-right and focus-to-left arrows; exposure indicator LEDs include shutter-speed LEDs, over- and underexposure warning LEDs; ready-light comes on when Nikon dedicated speedlight is used	±2 EV compensation (in one-third increments) possible with compensation dial; when film speed ring is set at DX with ISO 5000 DX-coded film, exposure compensation is possible from $-1\frac{1}{3}$ to +2; with film speed ring set at ISO 1600, $-1$ to +2 compensation is possible; at ISO 3200, only plus compensation is possible; at ISO 25, $-2$ to +1 compensation is possible; at ISO 12, only minus compensation possible
	<b>P Dual, P and P HI modes:</b> LED shows shutter speed selected by	<b>Film speed range</b>
		ISO 25 to 5000 for DX-coded film; ISO 12 to ISO 3200 for non-DX-coded film

<b>Film speed setting</b>	Automatically set to ISO speed of DX-coded film used; with non-DX-coded film, ISO speed is set manually
<b>Film loading</b>	Film automatically advances to first frame when shutter release button is depressed once; film advance indicator rotates to show that film is loaded and being advanced properly
<b>Film advance</b>	Film automatically advances to frame "1" after shutter release button is depressed; at S (single-frame shooting), film automatically advances one frame when shutter is released; at C (continuous shooting), the shutter fires as long as the shutter release button is depressed; film advance stops automatically at end of film roll

#### Firing rate in continuous shooting

Focus mode		Maximum firing rate (approx.)*	
		Without auto exposure lock	With auto exposure lock
Single Servo Autofocus		Not fixed—depends on subject status	
Continuous Servo Autofocus	Without focus lock	1.7 fps	1.4 fps
	With focus lock	2.5 fps	2.0 fps
Focus-assist operation/manual focus	With lenses other than AF Nikkor lenses	2.5 fps	2.0 fps
	With AF Nikkor lenses	1.7 fps	1.4 fps

\* With a fresh battery set and a shutter speed of 1/125 sec. or faster; at 68°F.

<b>Frame counter</b>	Accumulative type; automatically reset when camera back is opened
<b>Film rewind</b>	Manual
<b>Remote control</b>	Use Nikon optional Remote Cord MC-12A
<b>Audible warning alarm</b>	With switch on, beeps (1) when non-DX coded film is used with film speed scale set at DX; (2) when DX contacts require cleaning; (3) for over- or underexposure and possible picture blur in auto exposure modes; (4) at end of film roll; (5) during self-timer operation
<b>Red indicator lamp</b>	Blinks (1) when non-DX-coded film is used with the film speed scale set at DX, (2) when DX contacts require cleaning, (3) at end of film roll, (4) when shutter is released
<b>Self-timer</b>	Electronically controlled 10 sec. exposure delay; blinking LED and beep sound indicate self-timer operation; cancellable
<b>Reflex mirror</b>	Automatic, instant-return type
<b>Camera back</b>	Hinged back with film cartridge confirmation window and film advance indicator; swings open when film rewind knob is pulled up; changeable with Nikon Multi Data Back MF-19
<b>Accessory shoe</b>	Standard ISO-type with hot-shoe contact, ready-light contact, TTL flash contact, monitor contact

**Flash synchronization** 1/125 sec. or slower with electronic flash; with Nikon dedicated flash unit; automatically set to 1/125 sec. when camera is set at P DUAL, P, P HI, A or at manual setting of 1/250 sec. or higher; at slower manual speed, shutter fires at speed set

**Flash ready-light** Viewfinder thunderbolt LED lights up when Nikon dedicated speedlight is ready to fire

**Autofocus flash photography** Possible only with Nikon Autofocus Speedlight SB-20

**Power source** Four 1.5V AAA-type batteries\*; with optional Nikon AA Battery Holder MB-3, four 1.5V AA-type batteries can be used

\* Depending on the battery brand, some AAA-type NiCd batteries cannot be used;

**Number of 36-exposure film rolls per set of fresh batteries (approx.)\***

For focus-assist operation/manual focus

Batteries		At 68°F	At 14°F
AAA-type	Alkaline-manganese (LR03)	60	6
	NiCd (KR-AAA)	40	20
	Zinc-carbon (UM-4)	20	2
AA-type	Alkaline-manganese (LR06)	180	50
	NiCd (KR-AA)	120	60
	Zinc-carbon (SUM-3)	60	6

For Continuous Servo Autofocus with AF Nikkor lens covering the full range from infinity ( $\infty$ ) to the closest distance and back to infinity ( $\infty$ ) before each shot

Batteries		With AF Nikkor 50 mm f/1.8		With AF Nikkor 35-70 mm f/3.3-f/4.5	
		At 68°F	At 14°F	At 68°F	At 14°F
AAA-type	Alkaline-manganese (LR03)	30	3	45	3
	NiCd (KR-AAA)	20	10	30	10
	Zinc-carbon (UM-4)	10	—	15	—
AA-type	Alkaline-manganese (LR06)	120	20	130	20
	NiCd (KR-AA)	80	20	90	20
	Zinc-carbon (SUM-3)	40	5	45	5

\* With film advance mode selector at C for continuous shooting and a shutter speed of 1/125 sec. or faster.

**Dimensions** 148.5(W) × 97.5(H) × 54.5(D) mm  
[5.8(W) × 3.8(H) × 2.1(D) in.]

**Weight (body only)** Approx. 610g (21.3 oz.)

Specifications and designs shown herein are subject to change without notice.

# LENSES

**Only the lenses listed below can be mounted on the Nikon N2020; use of other lenses may damage the camera.**

All AF Nikkor lenses and other AI-type Nikkor lenses

All Series E lenses

Medical-Nikkor 120mm f/4 IF

Reflex-Nikkor 500mm f/8

Reflex-Nikkor 1000mm f/11

(No. 142360 or smaller, or No. 143001 or larger)

Reflex-Nikkor 2000mm f/11 (No. 200311 or larger)

PC-Nikkor 28mm f/3.5

PC-Nikkor 28mm f/4 (No. 180901 or larger)

PC-Nikkor 35mm f/2.8

(No. 851000 or smaller, or No. 906201 or larger)

For AI-modification of most non-AI Nikkor lenses having both an automatic diaphragm and meter coupling shoe, contact an authorized Nikon dealer. Even if AI-modified, the following lenses cannot be mounted on the Nikon N2020: Nikkor 55mm f/1.2 (No. 184711 ~ 400000), Nikkor 28mm f/3.5 (No. 625611 ~ 999999) and Nikkor 35mm f/1.4 (No. 385001 ~ 400000)

## AI-Type Nikkor Lens

Note meter coupling ridge and meter coupling shoe with two holes.



## Recognizing AI-S-type lenses

AI-S-type lenses are included among AI-type lenses.

Note lens-type signal notch and orange minimum aperture scale.

All Series E lenses are of the AI-S type.

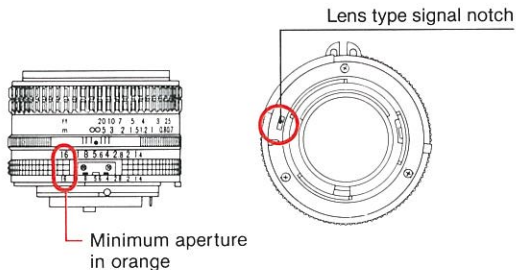

**Note:**

1. Do not use the following accessories with the Nikon N2020.  
K2 ring  
Macro Adapter Ring BR-2
2. PC-Nikkor lenses and Medical-Nikkor 120mm f/4 IF cannot be used in any auto exposure modes.
3. The following lenses and accessories do not have an aperture coupling device and cannot be used in the P DUAL, P and P HI modes.  
All Reflex-Nikkor lenses  
Bellows attachments  
Extension Ring Set K
4. In the P DUAL, P and P HI modes, when using AI-modified Nikkor lenses with maximum apertures of f/4.5 or slower, or teleconverters or PK rings, shutter speeds are slower than indicated by the program lines on p. 28. Although the actual shutter speed is indicated by the LED and correct exposure is assured even in these cases, check the LED indication to avoid blurred images at slower shutter speeds.
5. In the P DUAL, P and P HI modes, when using AI-modified Nikkor lenses with a maximum aperture faster than f/2, the metering range for higher EV values will be reduced to a maximum of two EVs depending on the aperture.

6. In the P DUAL, P and P HI modes, the following lenses may provide slower shutter speeds than those indicated by the viewfinder LED, but you still get correct exposure.

Nikkor 50 mm f/1.2 (No. 250525 or smaller)

Noct-Nikkor 58 mm f/1.2 (No. 175000 or smaller)

Zoom-Nikkor 50 ~ 300 mm f/4.5 ED (No. 179500 or smaller)

AI-modified Nikkor 85 mm f/1.8

AI-modified Micro-Nikkor 105 mm f/4

AI-modified Zoom-Nikkor 85 ~ 250 mm f/4

**When using Nikon Teleconverters:** Depending on the lens in use, in the A mode, the shutter speed may be faster than that indicated in the viewfinder by one step or less; also, in the manual exposure mode, exposure compensation may be necessary. For details, refer to the teleconverter's instruction manual.

## Compatibility of Lenses for Autofocus/Focus-Assist Operations

### Autofocus

All AF Nikkor lenses can be used.

### Focus-assist operation

All AI-type Nikkor and Series E lenses with a maximum aperture of  $f/4.5$  or faster, plus Medical-Nikkor 120mm  $f/4$  IF can be used.

For the following Nikkor lenses, the figure on the right specifies the closest usable focusing distance.

135mm $f/2.8$	1.7m (approx. 12.6ft)
180mm $f/2.8$	2.5m (approx. 8.2ft)
200mm $f/4$	2.5m (approx. 8.2ft)
300mm $f/4.5$	12m (approx. 39.4ft)
Micro 105mm $f/4$	0.8m (approx. 2.6ft)

For focusing distances closer than those specified, the focus indicator LEDs may not always be reliable—use the clear matte field to secure subject focus.

### Autofocus (with Autofocus Converter TC-16A)

Following AI-type (excluding AI-modified) lenses can be used:

#### AF

28mm  $f/2.8$   
50mm  $f/1.4$   
50mm  $f/1.8$   
80mm  $f/2.8$  (for F3AF)

#### Fisheye

6mm  $f/2.8$   
8mm  $f/2.8$   
16mm  $f/2.8$

#### Wideangle

24mm  $f/2$   
24mm  $f/2.8$   
28mm  $f/2$  (No. 540021 or larger)  
28mm  $f/2.8$  (No. 500001 or larger)  
35mm  $f/1.4$  (use AI-S type lens only)  
35mm  $f/2$  (No. 931001 or larger)  
35mm  $f/2.8$  (No. 880001 or larger)

#### Normal

50mm  $f/1.2^a$   
50mm  $f/1.4$  (No. 3980001 or larger)  
50mm  $f/1.8$   
50mm  $f/1.8$  (N)  
50mm  $f/2$  (No. 3640001 or larger)  
55mm  $f/1.2$

#### Telephoto

85mm  $f/1.4^b$   
85mm  $f/2$   
105mm  $f/1.8^b$

105mm  $f/2.5$   
135mm  $f/2$   
135mm  $f/2.8^c$   
180mm  $f/2.8$  ED<sup>a, b, c</sup>  
180mm  $f/2.8^a, b, c$   
200mm  $f/2$  IF-ED<sup>a, b</sup>  
300mm  $f/2$  IF-ED<sup>d</sup>  
300mm  $f/2.8$  IF-ED<sup>d</sup>

#### Zoom

80 ~ 200mm  $f/2.8$  ED

#### Special

Noct 58mm  $f/1.2^a, b$   
Micro 55mm  $f/2.8$   
Micro 105mm  $f/2.8^c$

#### Series E

28mm  $f/2.8$   
35mm  $f/2.5$   
50mm  $f/1.8$   
100mm  $f/2.8$   
135mm  $f/2.8^c$

<sup>a</sup> Slight vignetting may occur at close focusing distance.

<sup>b</sup> Uneven exposure may occur at high shutter speeds and apertures smaller than  $f/11$ .

<sup>c</sup> Usable focusing distance is limited. (See the TC-16A's instruction manual for details.)

<sup>d</sup> Use smallest possible aperture (larger f-number) to avoid vignetting.



No reproduction in any form of this booklet, in whole or in part (except for brief quotation in critical articles or reviews), may be made without written authorization from Nippon Kogaku K.K.

**NIPPON KOGAKU K.K.**

Fuji Bldg., 2-3, Marunouchi 3-chome, Chiyoda-ku, Tokyo 100, Japan

**Phone:** 81-3-214-5311 **Telex:** J22601 (NIKON)

**Fax:** 81-3-201-5856

Printed in Japan 8&087-A004