

INC

VBA22001-R. 3754. A

作成承認印

配布許可印



Nikon

D700

VBA22001

REPAIR MANUAL

Nikon | NIKON CORPORATION
Tokyo, Japan

Copyright © 2008 by Nikon Corporation.
All Rights Reserved.
無断転載を禁ず !!

Contents

Disassembly

Points to notice for Disassembly and Assembly	D 1
--	-----

1.External area and Image-related PCB/base plate

External rubber	D 2
Battery lid	D 4
Bottom cover	D 4
Removal of Back cover	D 6
Back cover unit /CF cover unit	D 9
I/F cover	D 11
Discharge of Main condenser	D 12
DG shield plate unit	D 12
DG-PCB	D 13
Image sensor unit	D 16
CF-PCB	D 17
Diopter adjustment knob	D 19
Eyepiece	D 20
Removal of top cover	D 21

2.Top cover

Main condenser	D 26
CD unit	D 26
SB-PCB unit	D 28
Release-SW	D 29
S B	D 30
Top cover FPC unit	D 33
Main SW	D 36
Mode dial	D 40
Top cover external parts	D 42

3.Separation of Front body from Rear body

DC/DC-PCB	D 45
Main-PCB	D 47
AF-assist lamp	D 51
Grip-support mold	D 51
Separation of Front body from Rear body	D 52

4.Separation of Prism box unit from Front body unit

Separation of Prism box unit from Front body unit	D 55
---	------

5.Prism box unit

Metering FPC unit	D 58
Screen	D 59
Penta prism	D 61
Diopter adjustment mold	D 62
Diopter adjustment unit	D 63
Inside finder LCD unit	D 64
SI unit	D 65

6.Front body unit

Power drive	D 70
AF sensor	D 72
Bayonet	D 75
Separation of front cover from Front body	D 76
Front cover	D 77
Release button	D 78
separation of Mirror box and front body	D 79
10-pin FPC	D 81
AF driving base unit	D 82
Function buttom	D 83
Lens contact	D 84
Front body accessories	D 85
Mirror box	D 85

7.Rear body

IF-PCB	D 86
Piezoelectric buzzer	D 87
Charge base plate unit	D 87
Shutter unit	D 89
Power base unit	D 90
Grip unit	D 91
Battery contact mold	D 92
Rear body accessories	D 93

Assembly / Adjustment

1.Rear body

Rear body accessories	A 1
Battery contact mold	A 2
Grip unit	A 4
Power base unit	A 5

Shutter unit A 6
Charge base plate unit A 7
Piezoelectric buzzer A 9
IF-PCB A 10

2. Front body unit

Mirror box A 11
Front body accessories A 11
Lens contact A 12
Function button A 13
AF driving base unit A 14
10-pin FPC A 15
Mounting of Mirror box on Front body A 15
Release button A 17
Front cover A 18
Mounting of Front cover on Front body A 19
Bayonet A 21
Height adjustment of AF coupling shaft A 22
Height adjustment of Aperture lever A 22
AF sensor A 23
Power drive A 26

3. Prism box unit

SI unit A 28
Inside finder LCD unit A 33
Diopter adjustment unit A 34
Diopter adjustment Mold A 35
Penta prism A 37
Screen A 38
Metering FPC unit A 40

4. Mounting of Prism box unit on Front body unit

Mounting of prism box unit on front body unit A 41
Angle adjustment of Main mirror and sub-mirror A 45

5. Mounting of Front body on Rear body

Mounting of front body on rear body A 47
Inspection and Adjustment of Body back A 50
Grip-support mold A 52
AF-assist lamp A 53
Main-PCB A 53

DC/DC-PCB	A 57
Inspection and adjustment of AE CCD positioning	A 61

6. Top cover



Top cover external parts	A 63
Mode dial	A 65
Main SW	A 68
Top cover FPC unit	A 71
S B	A 74
Release-SW	A 77
SB-PCB unit	A 78
CD unit	A 80
Main condenser	A 81

7. External Section and Imaging-related PCB

Mounting of Top cover	A 82
Inspection and Adjustment of M1/8000 accuracy	A 87
Inspection and adjustment of Shutter monitor	A 88
Battery check voltage inspection	A 89
Eyepiece	A 90
Diopter adjustment knob	A 91
CF-PCB	A 92
Image sensor unit	A 93
Writing of the image sensor unique data	A 94
DG-PCB	A 96
DG shield plate unit	A 99
I/F cover	A 99
How to connect camra and PC	A 101
D700 Inspection and Adjustment Software	A 102
Procedure for installing USB driver	A 106
AE inspection and adjustment	A 108
AF inspection and adjustment	A 110
Adjustments on PC required when parts are replaced(Camera)	A 113
Back cover unit /CF cover unit	A 114
Mounting of Back cover	A 119
Bottom cover	A 122
Battery lid	A 123
External rubber	A 124
Shooting-image Adjustment	A 126
Adjustments on PC required when parts are replaced(image)	A 127

Setting of two-dimensional barcode reader	A 129
Imageing unit adjustment	A 132
∞ Infinity focus inspection & adjustment	A 138
D700 Tilted sensor checking chart	A 139
Wiring	E 1 ~ E 2
Mounting Drawing	E 3 ~ E 15
Inspection Standards	R 1 ~ R 7
Tools	T 1 ~ T 5

Points to notice for Disassembly and Assembly

 WARNING	
	<ul style="list-style-type: none">● There are high voltage parts inside. Be careful of this electric shock, when you remove the cover.● You must discharge the main condenser according to the instruction of this repair manual after you remove the cover.

Caution:

- ① In disassembly/(re)assembly, be sure to use conductive mat (J5033) and wrist strap (J5033-5), in order to protect electric parts from static electricity.
- ② Before disassembling, be sure to remove batteries or AC power cord.
- ③ In disassembling, be sure to memorize the processing state of wires and FPC, screws to be fixed and their types, etc.
- ④ The low-pass filter of the image PCB/base plate is easily damaged. Handle it very carefully.

Points to notice for Lead-free solder products
<ul style="list-style-type: none">▪ Lead-free solder is used for this product.▪ For soldering work, the special solder and soldering iron are required.▪ Do NOT mix up lead-free solder with traditional solder.

Caution:

When "Separation of Front body from Rear body", "Disassembly of Image sensor unit" and "Disassembly of Bayonet" are performed, be sure to carry out "RESET AF-DEFOCUS COMPENSATION" of the D700 adjustment software after assembly.

Disassembly

1. External area and Image-related PCB/base plate

External rubber

- Remove the rubber cap (#68).
- Remove the bottom cover unit (#B63).



- Remove the rear rubber unit (#B447) from the back.



- Remove the I/F rubber unit (#B10061).



- Take out the screw (#1647).

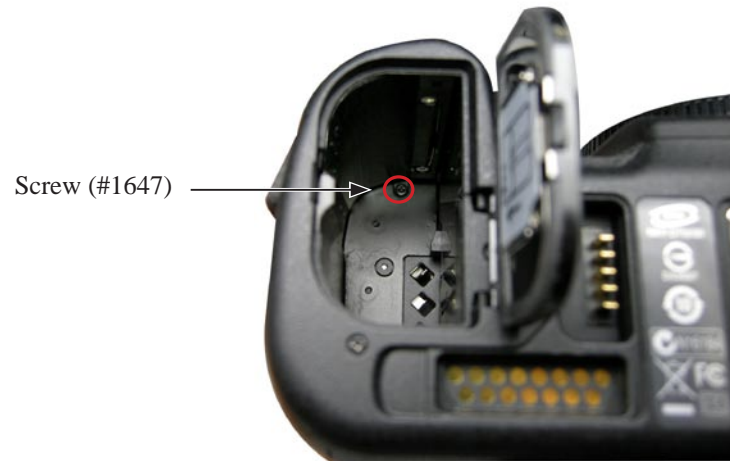

- Remove the grip rubber unit (#B60).

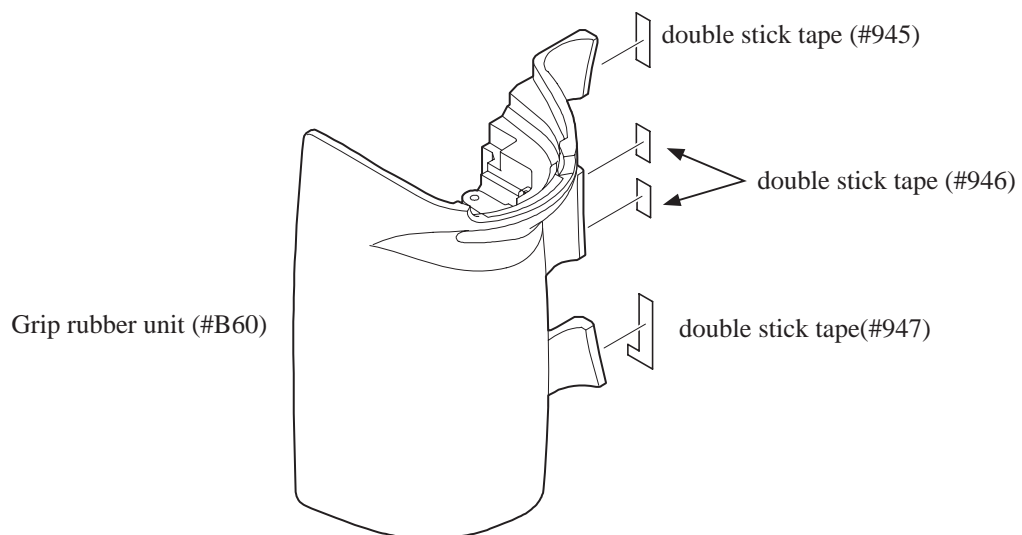

Battery lid

- Remove the battery lid unit (#B801).

Caution: Remove [#B801] sideways so as not to break the shaft.



Bottom cover

- Take out the screw (#1509).



- Take out the screw (#1509).
- Remove the DOUBLE STICK TAPE (#883)

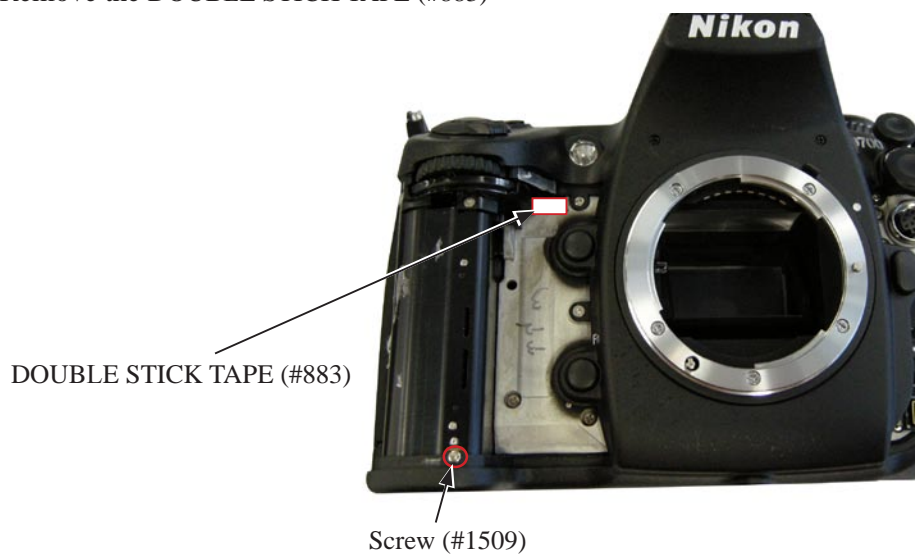

- Take out the two screws (#1529).
- Take out the two screws (#1528).
- Take out the three screws (#1517).

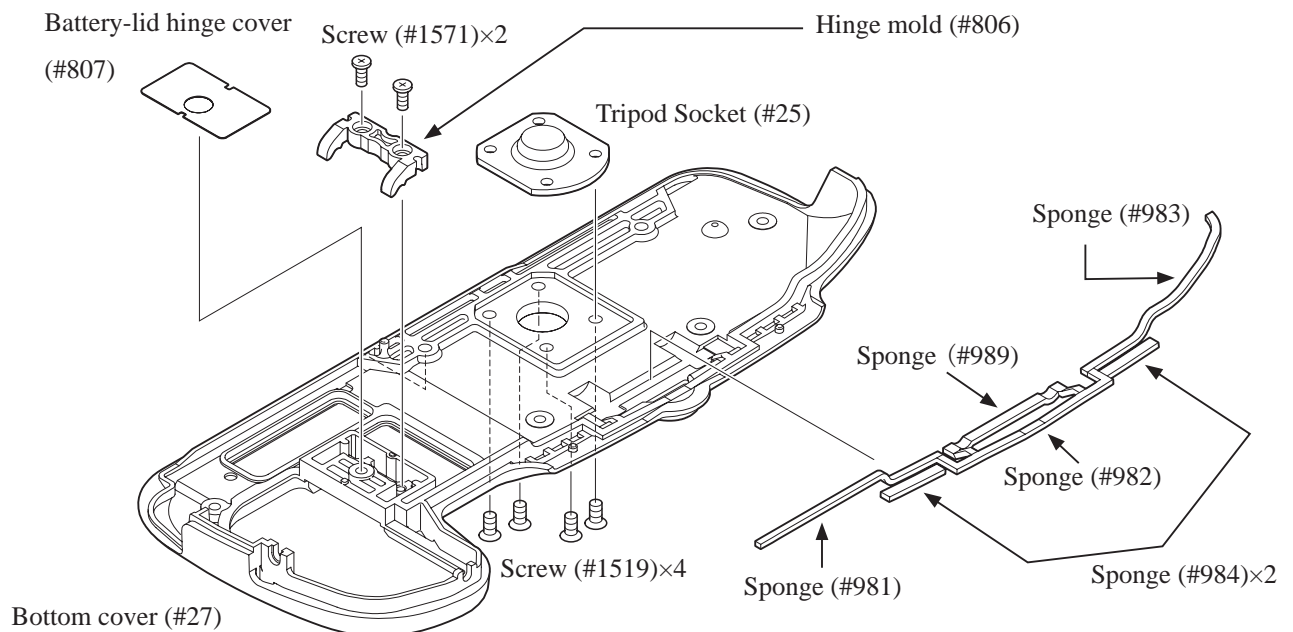
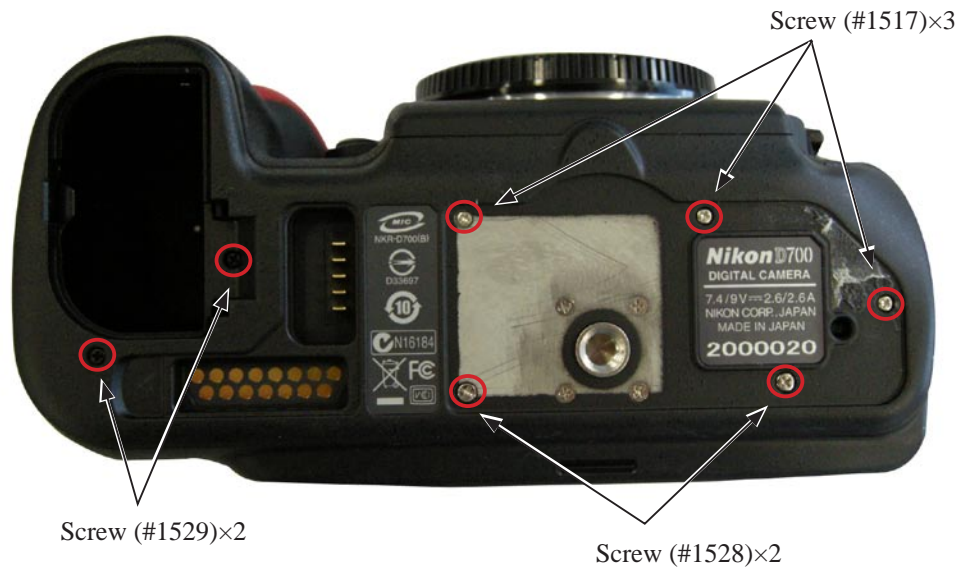

Removal of Back cover

- Take out the two screws (#1529).

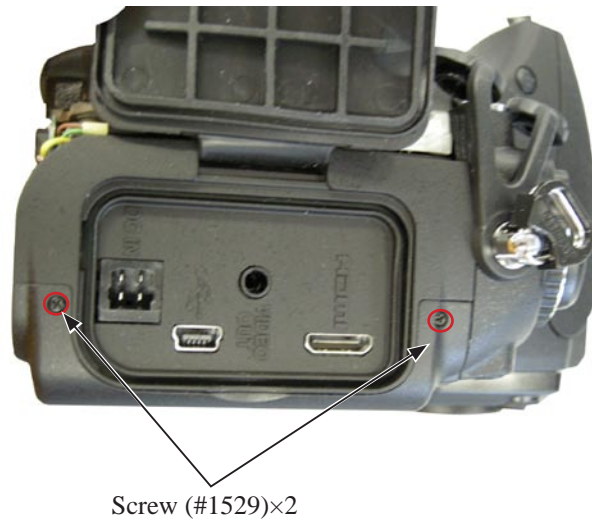

- Take out the two screws (#1545).

Caution: △ (Addition)
In case the length of the screw is different between ① and ②, use the longer one for ①.

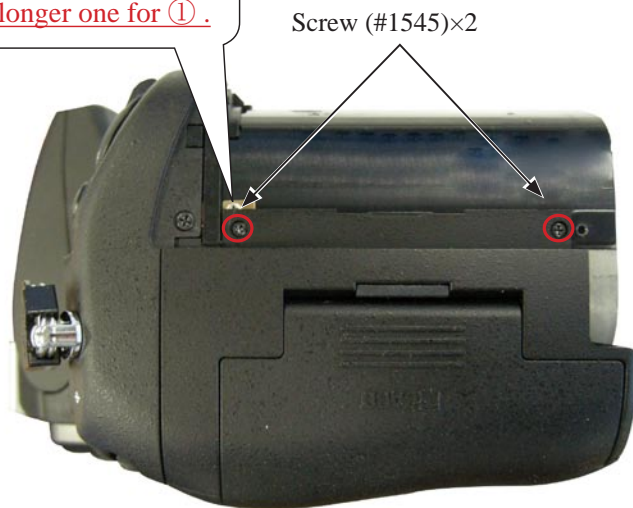

- Take out the screw (#1551).



- Remove the back cover.

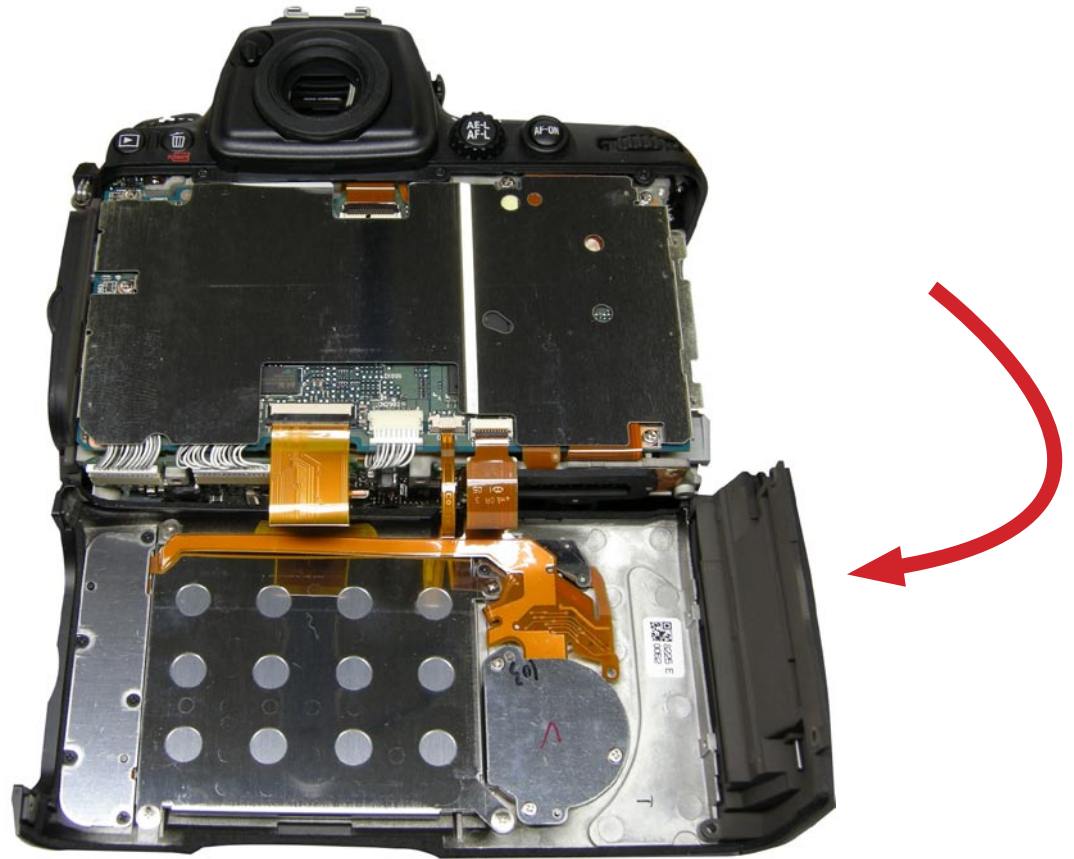

- Remove the FPC at three places.

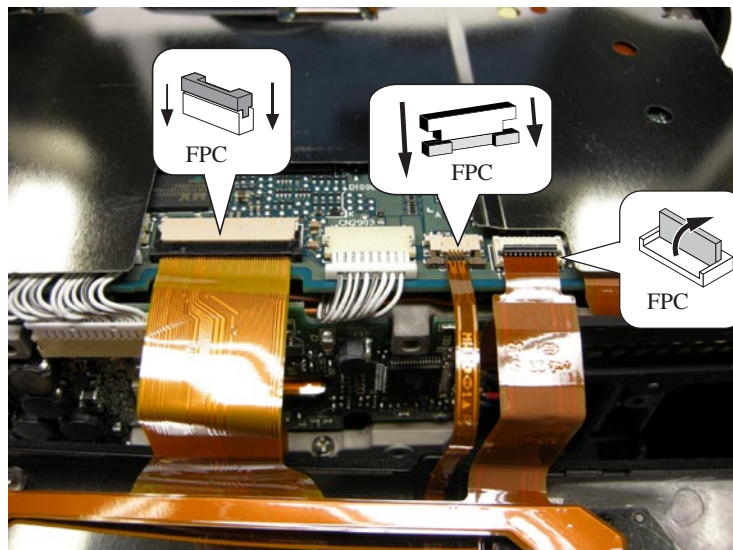

- Take out the two screws (#1518).

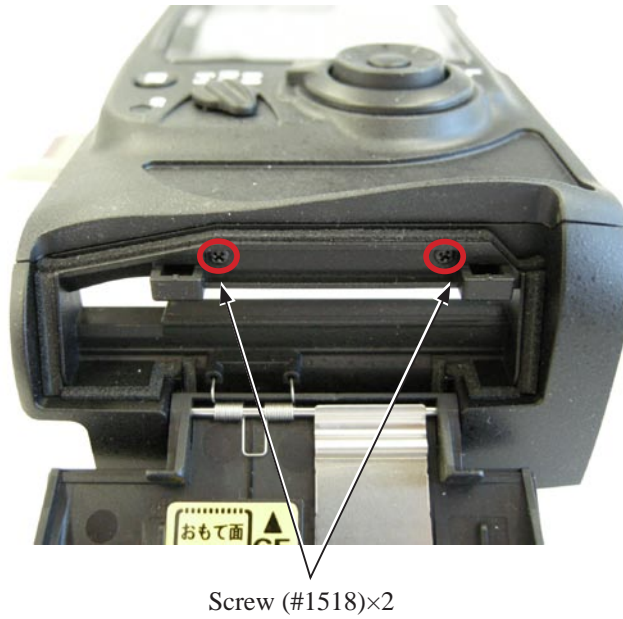

- Remove the CF cover unit (#B441) from the back cover unit (#B421RP).

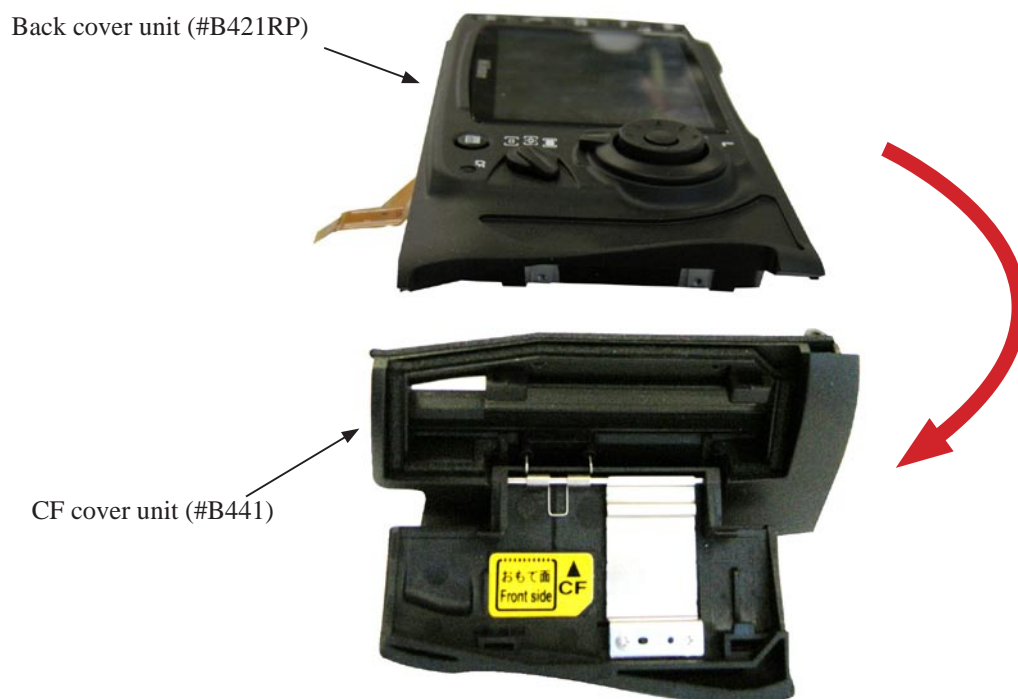

Back cover unit / CF cover unit

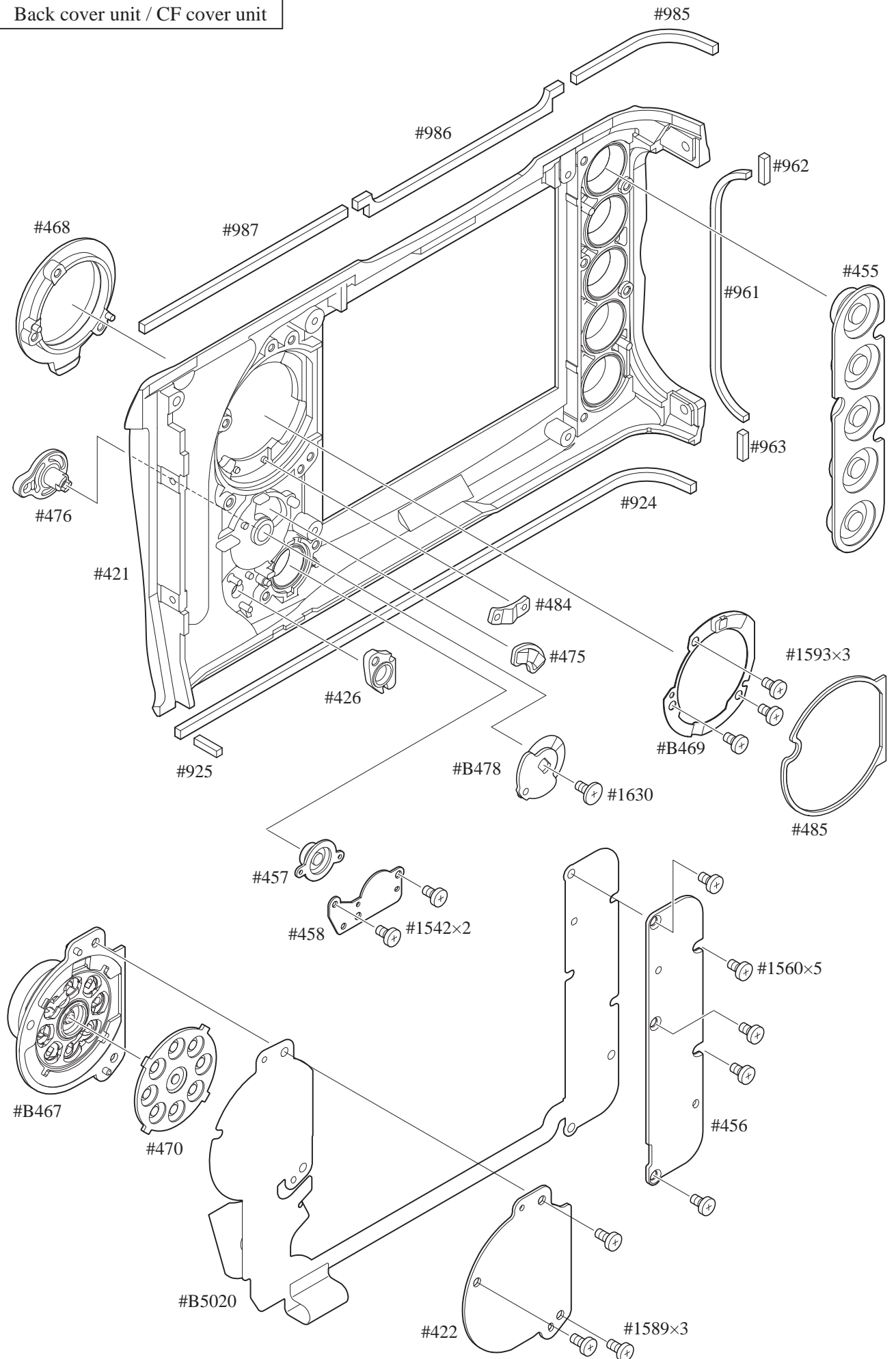

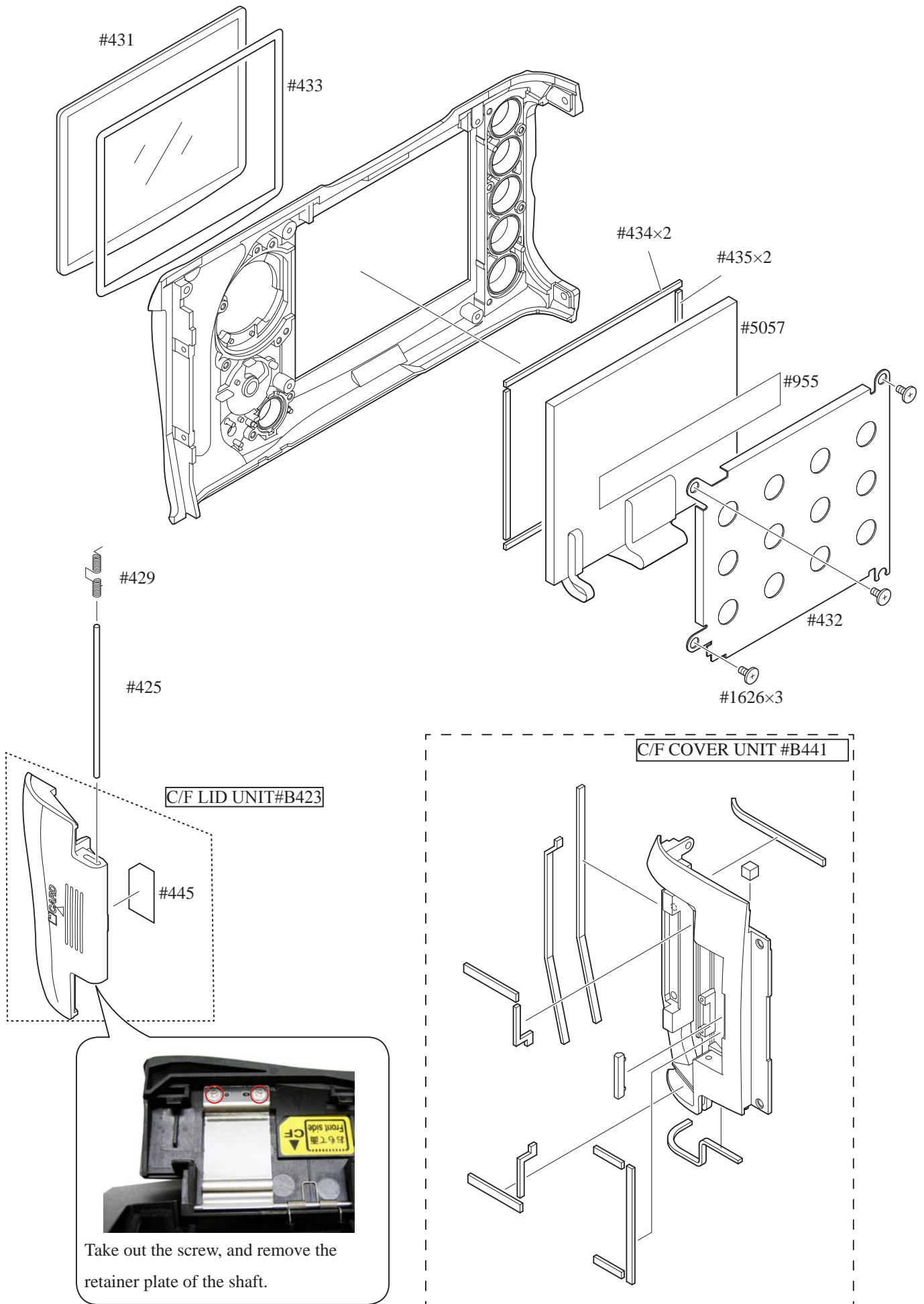

I/F cover

- Take out the two screws (#1510).
- Remove the I/F cover (#28).

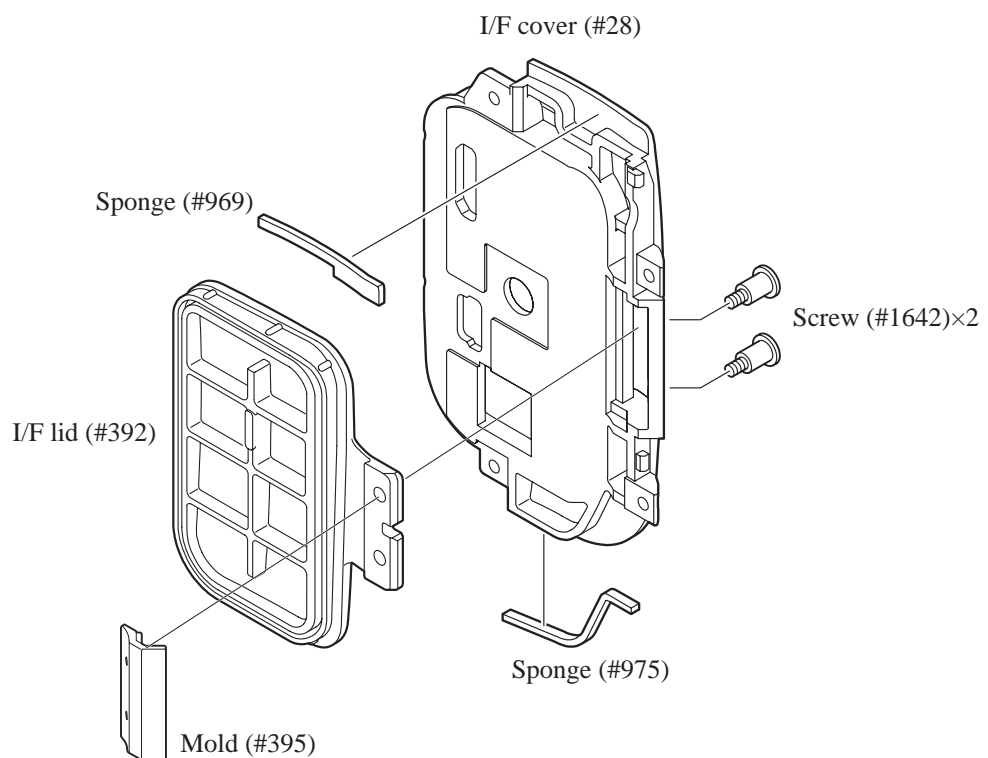
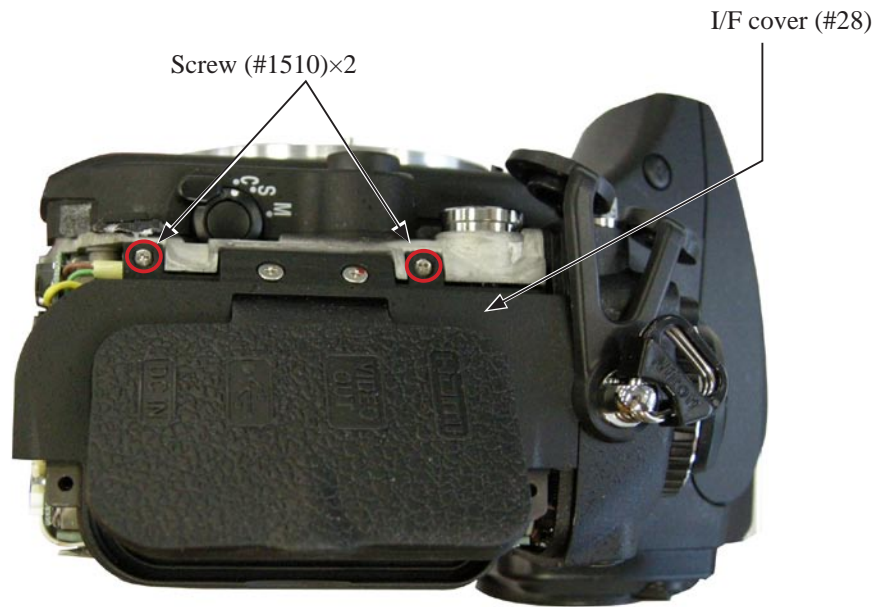

Discharge of Main condenser

- Discharge the main condenser (#5067).

Be careful NOT to touch the body during discharging.

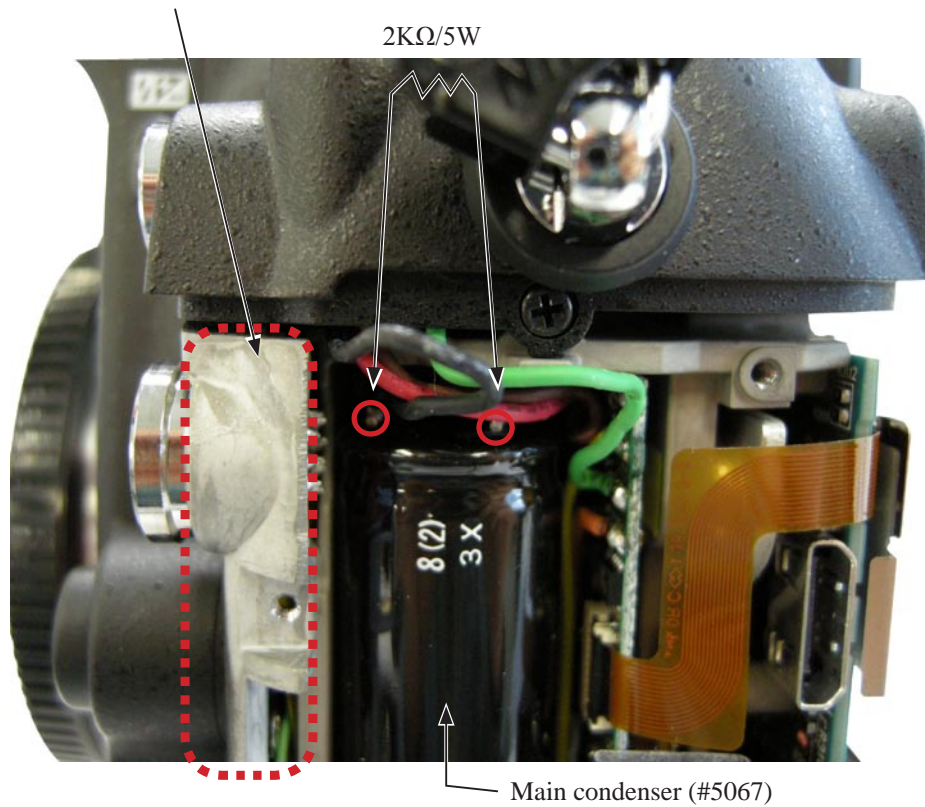

DG shield plate unit

- Take out the five screws (#1521), and remove the shield plate unit (#B683).



DG-PCB

- Remove the FPC.
- Disconnect the connector at two places.

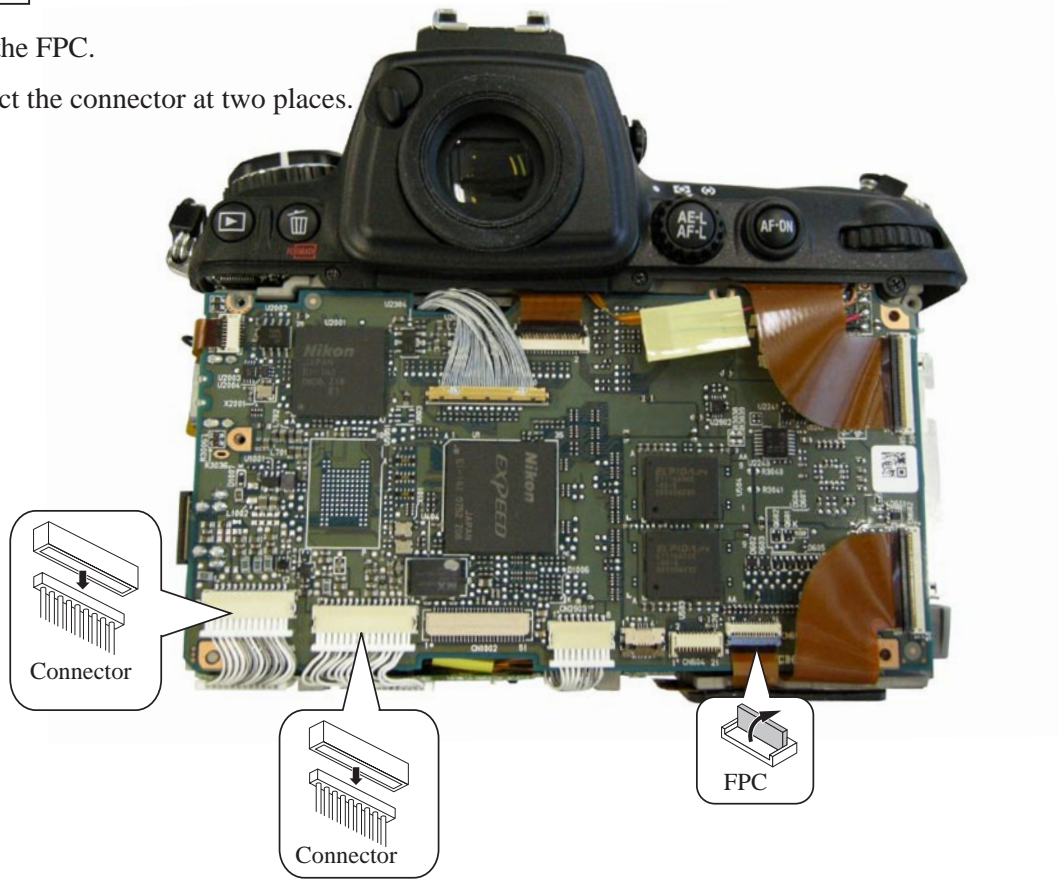

- Remove the FPC at four places.
- Disconnect the connector at two places.

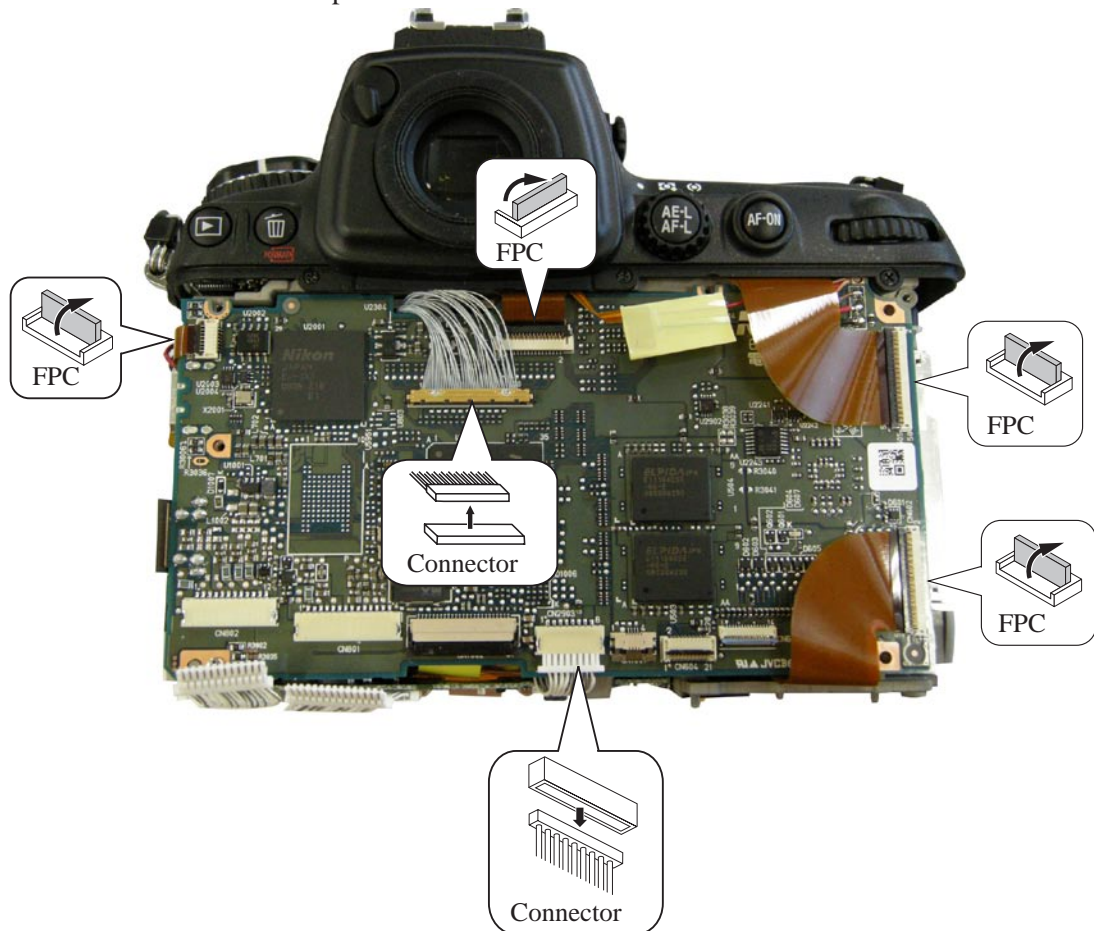

- Remove the power pack connection-FPC.

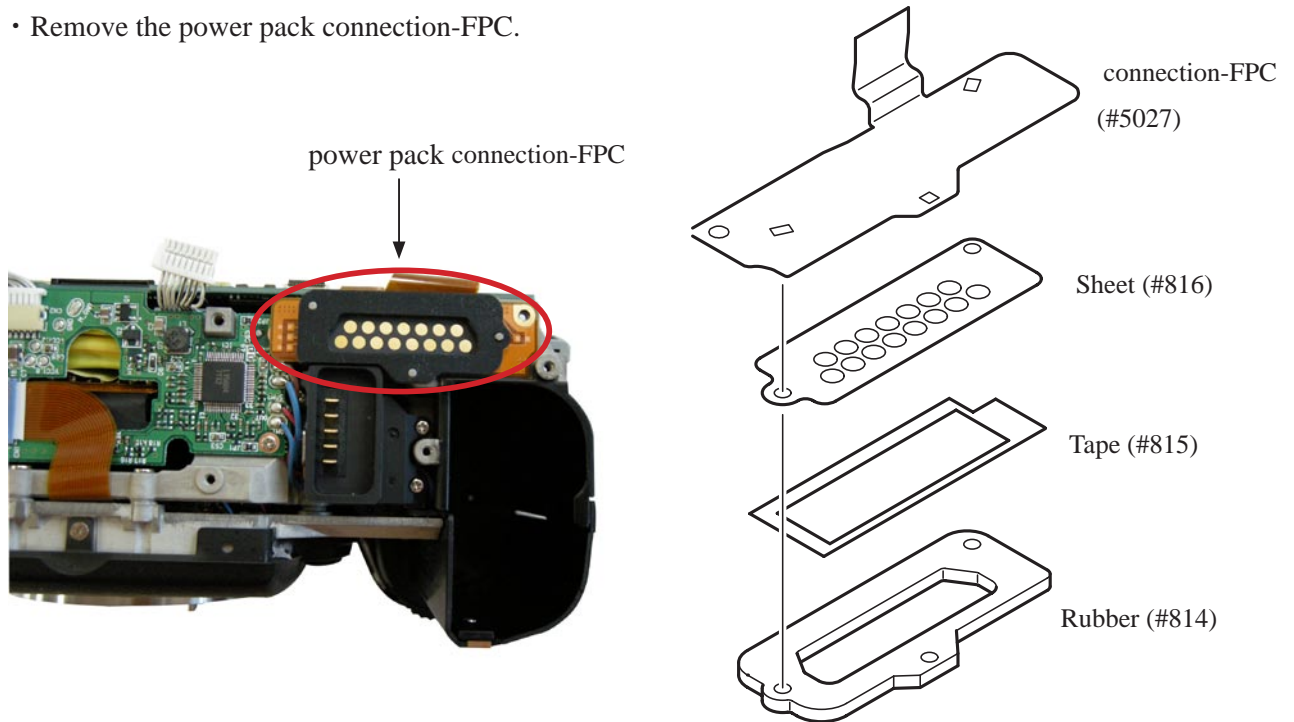

- Unsolder the wires {[Red (thick)][Black (thick)][Brown]}.

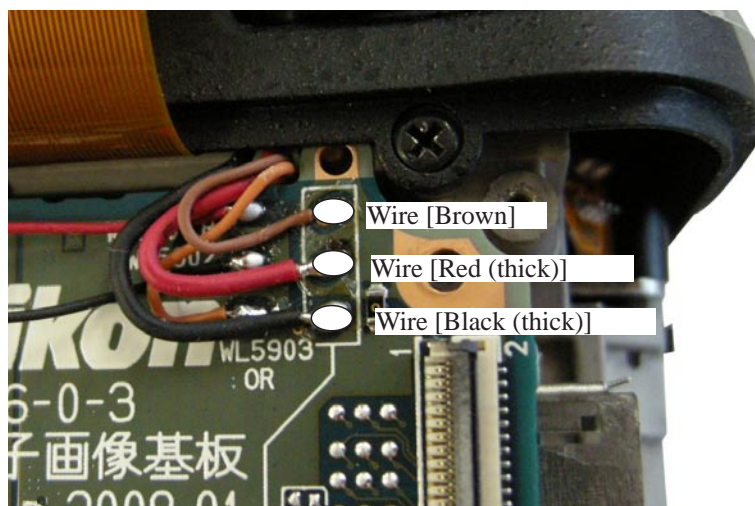

- Unsolder the wires ([Red (thin)][Black (thin)][Orange]).

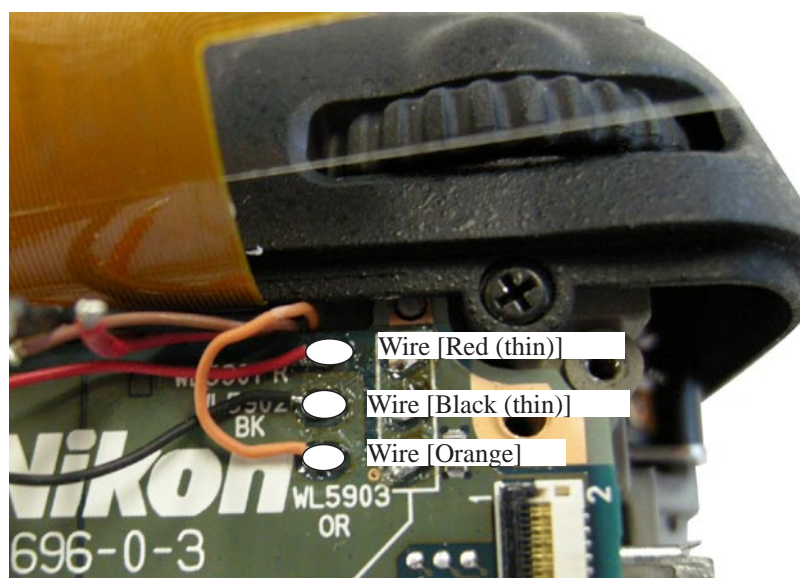

- Take out the screw (#1521), and remove the DG-PCB unit (#B5017RP).

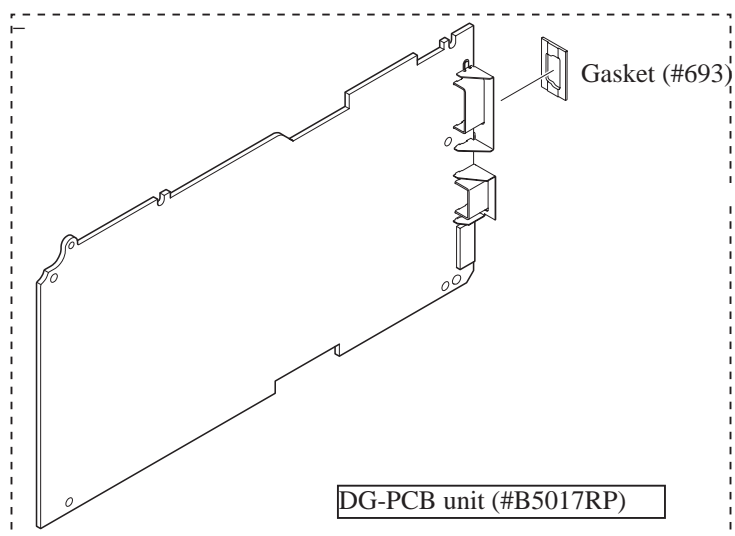
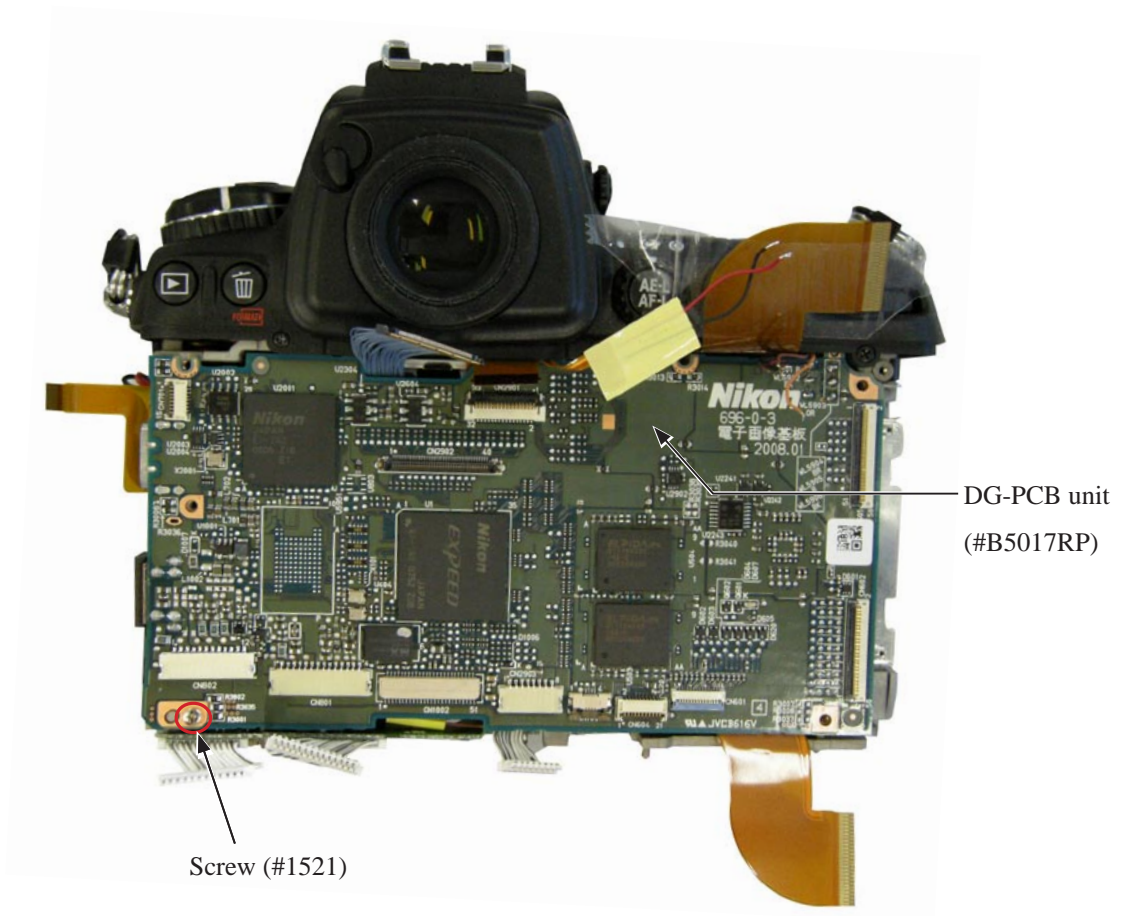
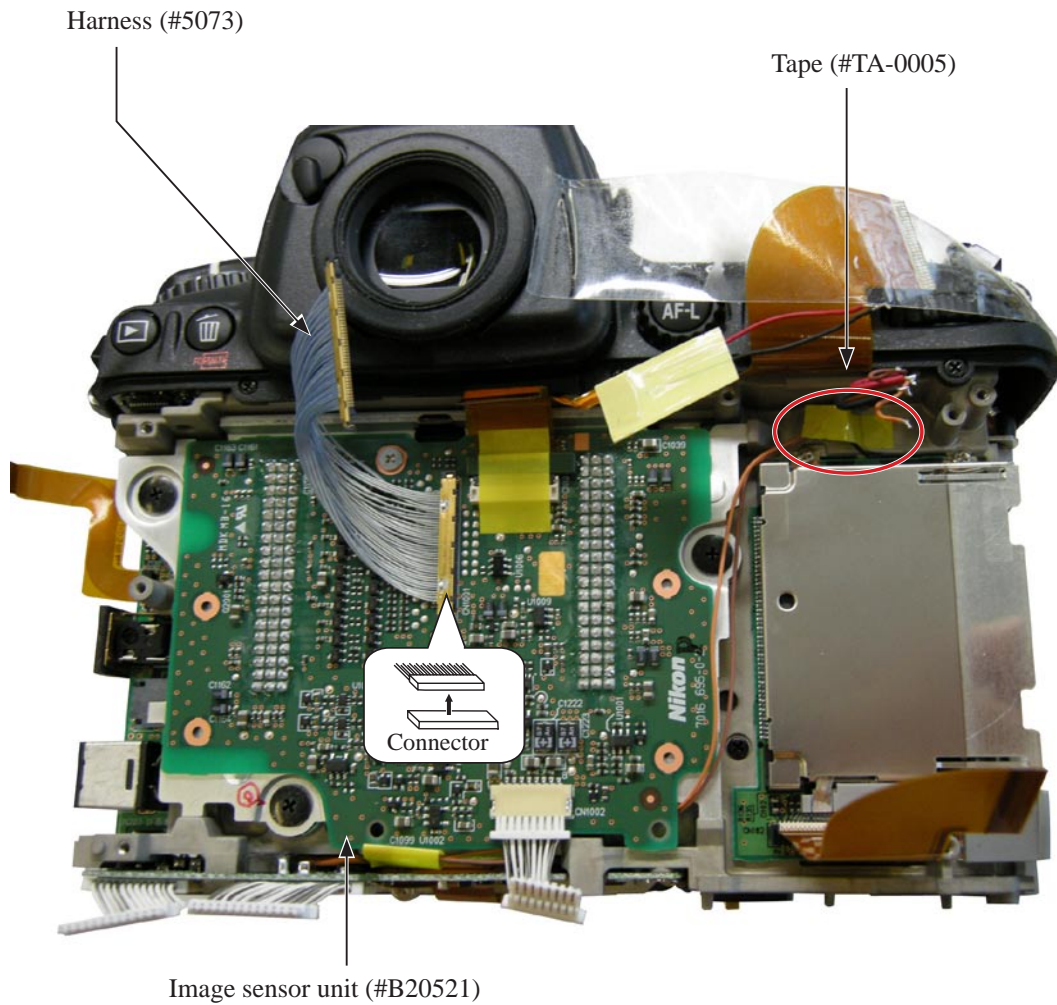
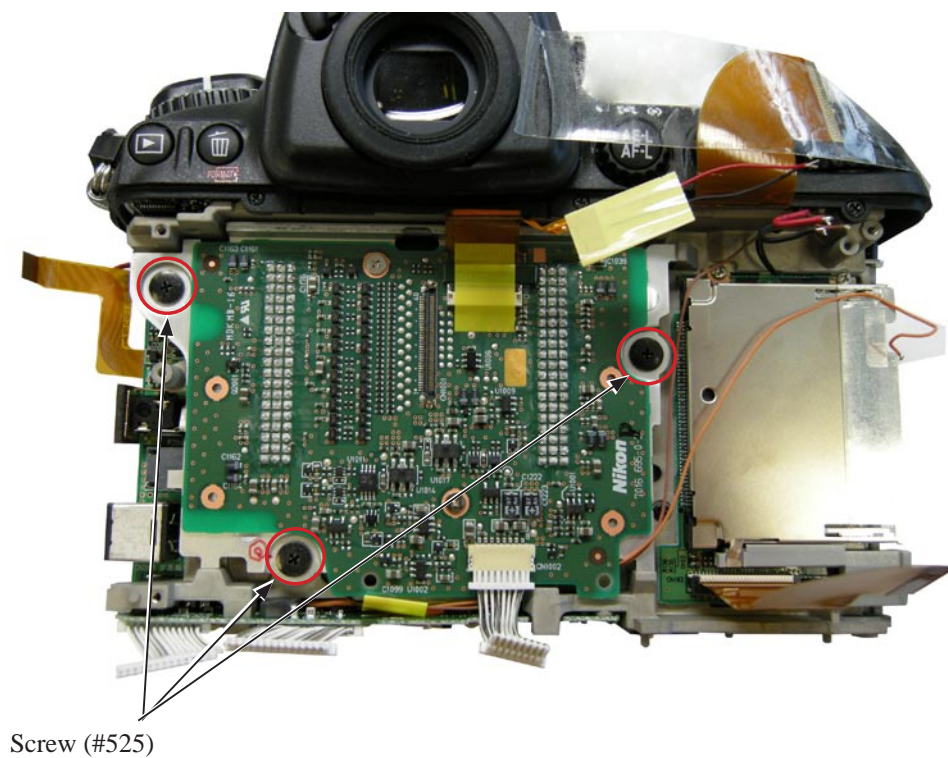

Image sensor unit

- Remove the harness (#5073) from the image sensor unit (#B20521).
- Peel off the tape [#TA-0005 (5×15)].



- Take out the three screws (#525).



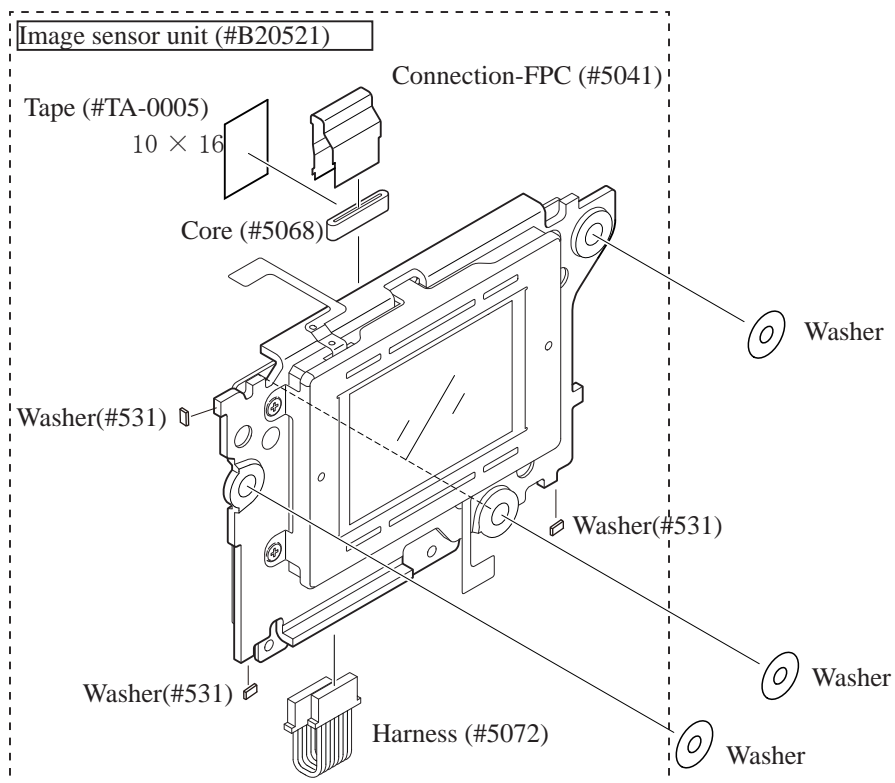

Washer #534	T=0.02
Washer #535	T=0.1
Washer #536	T=0.06
Washer #531	T=0.1

CF-PCB

- Position the lever of the CF-PCB (#5018) toward the direction of the arrow, and take out the three screws (#1543).

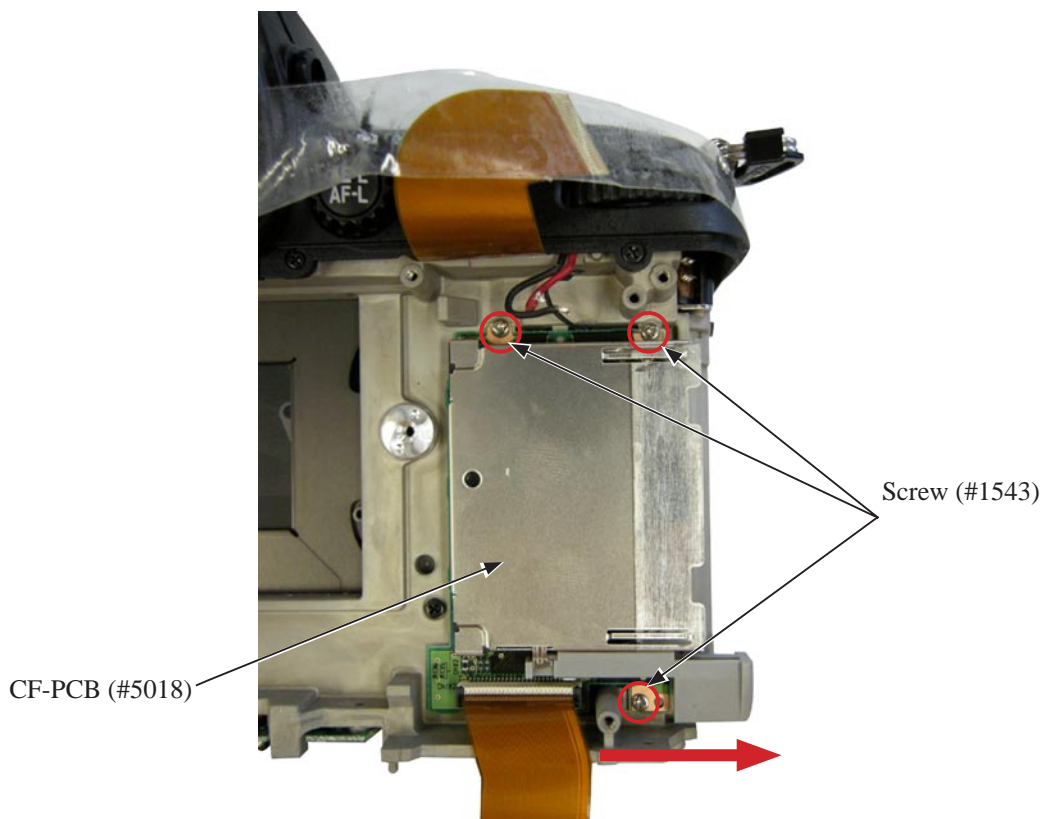

- Remove the CF-PCB (#5018) from the body.

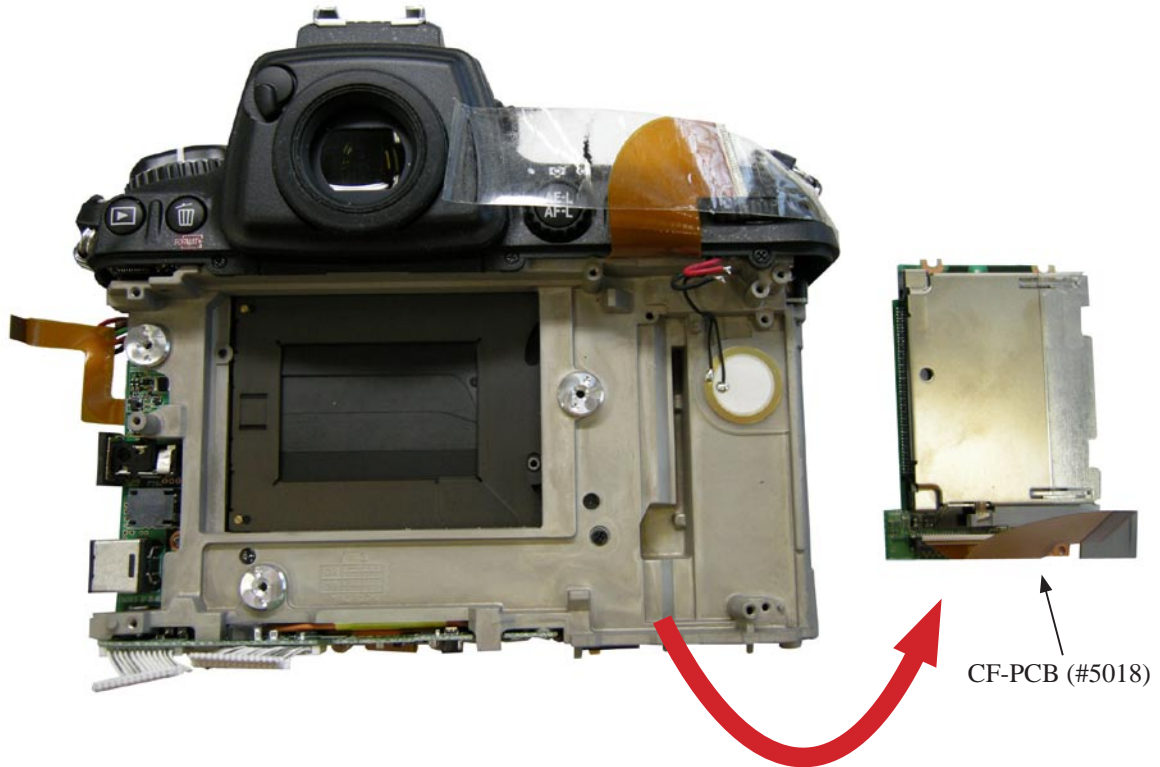

- Remove the connection-FPC (#5038) from the CF-PCB (#5018).

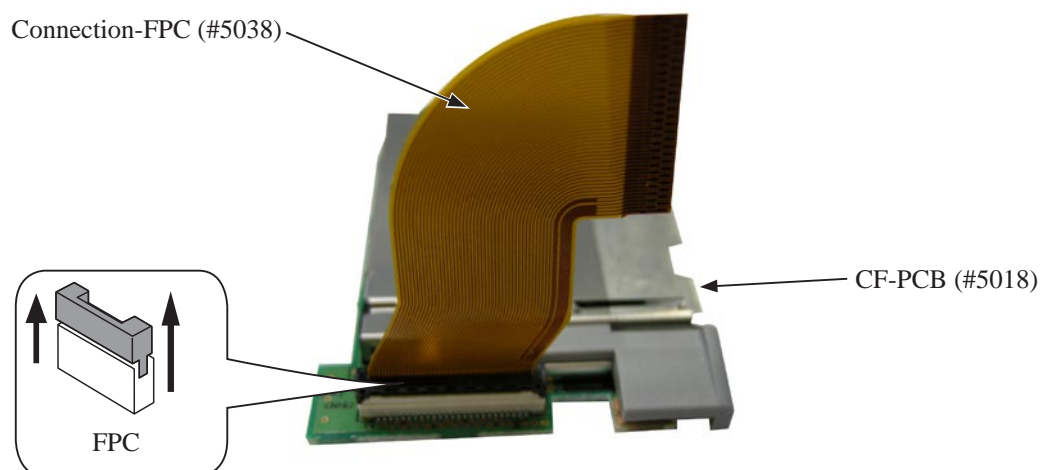

Diopter adjustment knob

- Remove the Cover (#1130).



- Take out the screw (#1552).
- Remove the diopter adjustment knob (#1121).

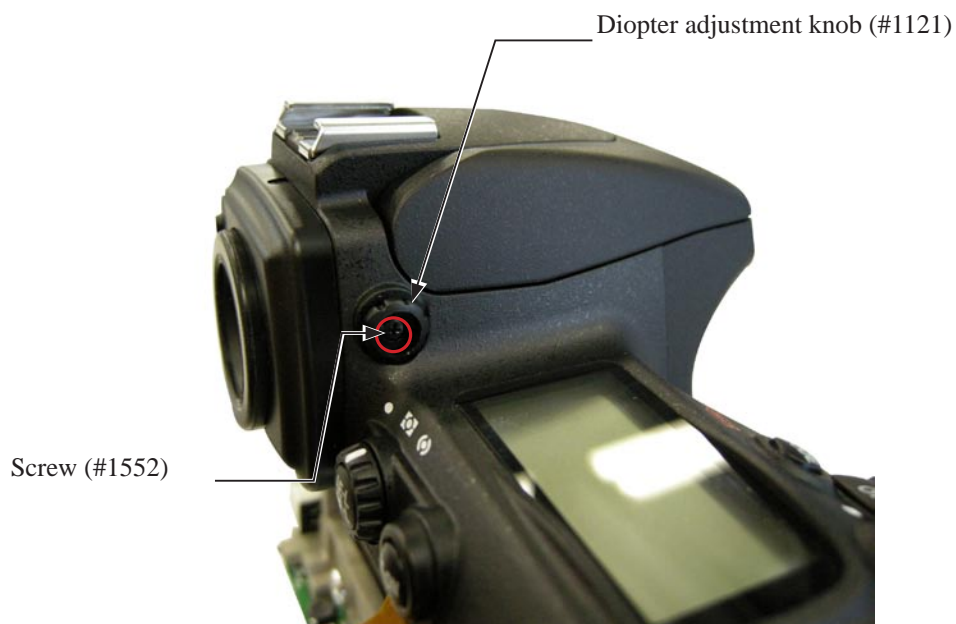

Eyepiece

- Take out the screw (#1534).

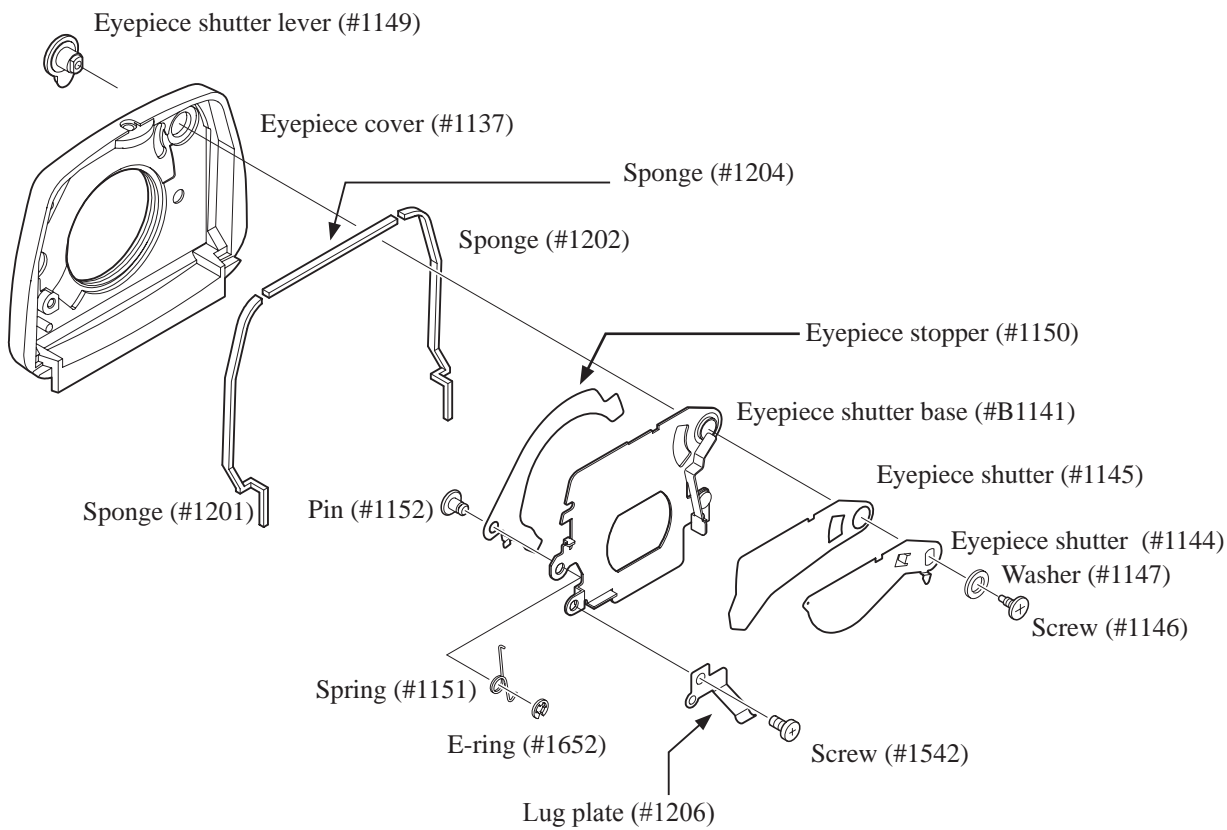

Removal of top cover

- Use a plastic plate (of 0.2mm in thickness), and pull out the main condenser (#5067) as below.

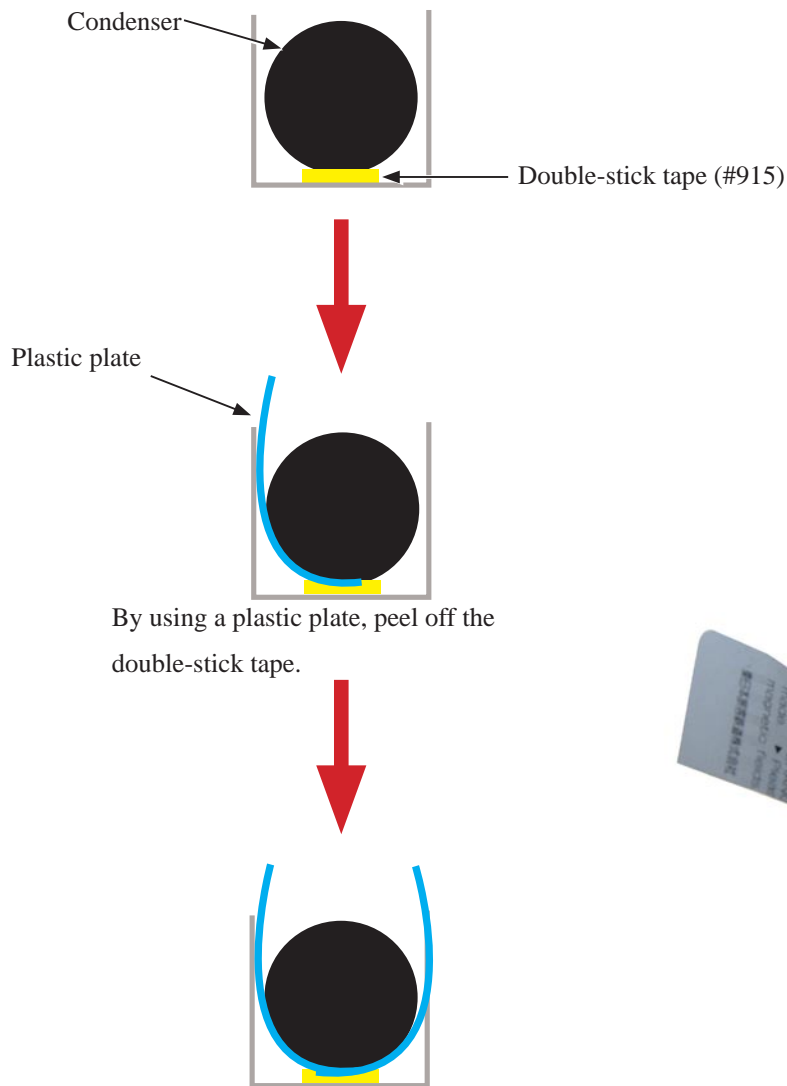

By using a plastic plate, peel off the double-stick tape.

Insert another plastic plate from the opposite side, and pull out the condenser by kind of scooping it up.

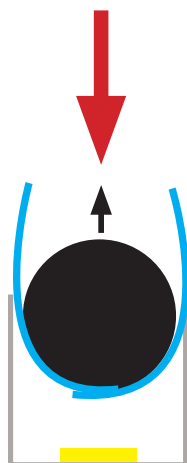

Pull out parallel to the bottom.

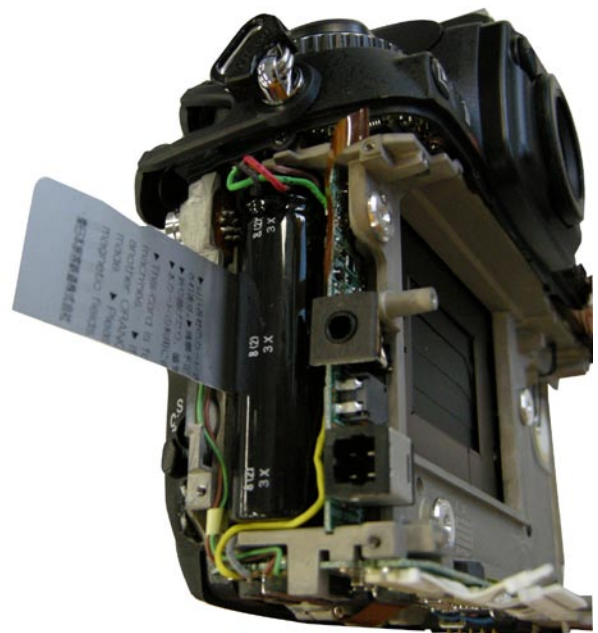

- Unsolder the wires ([Green][Brown]).

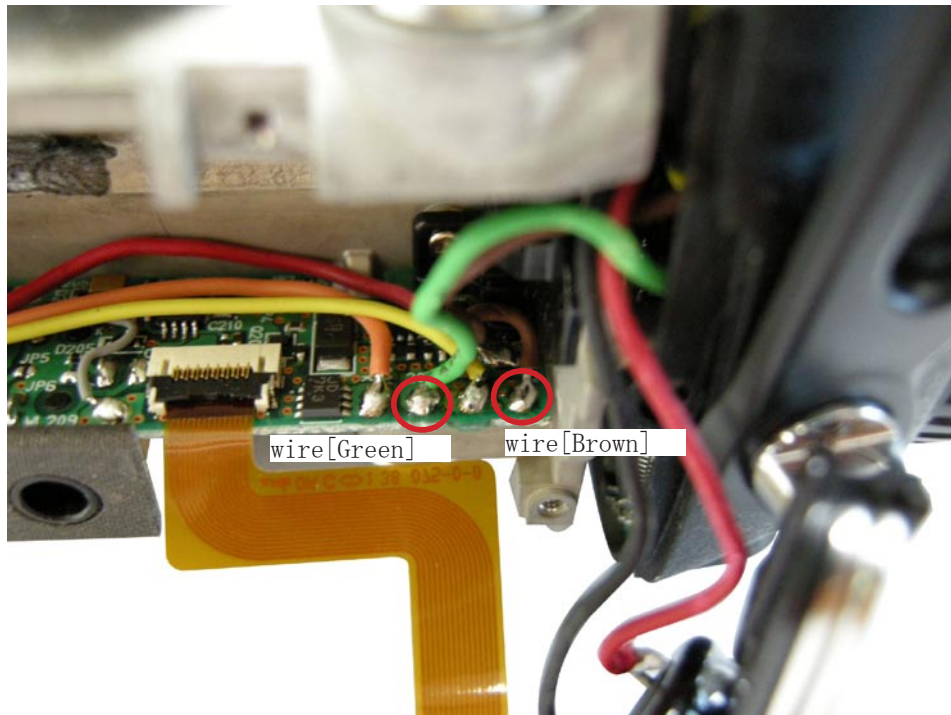

- Take out the two screws (#1512).

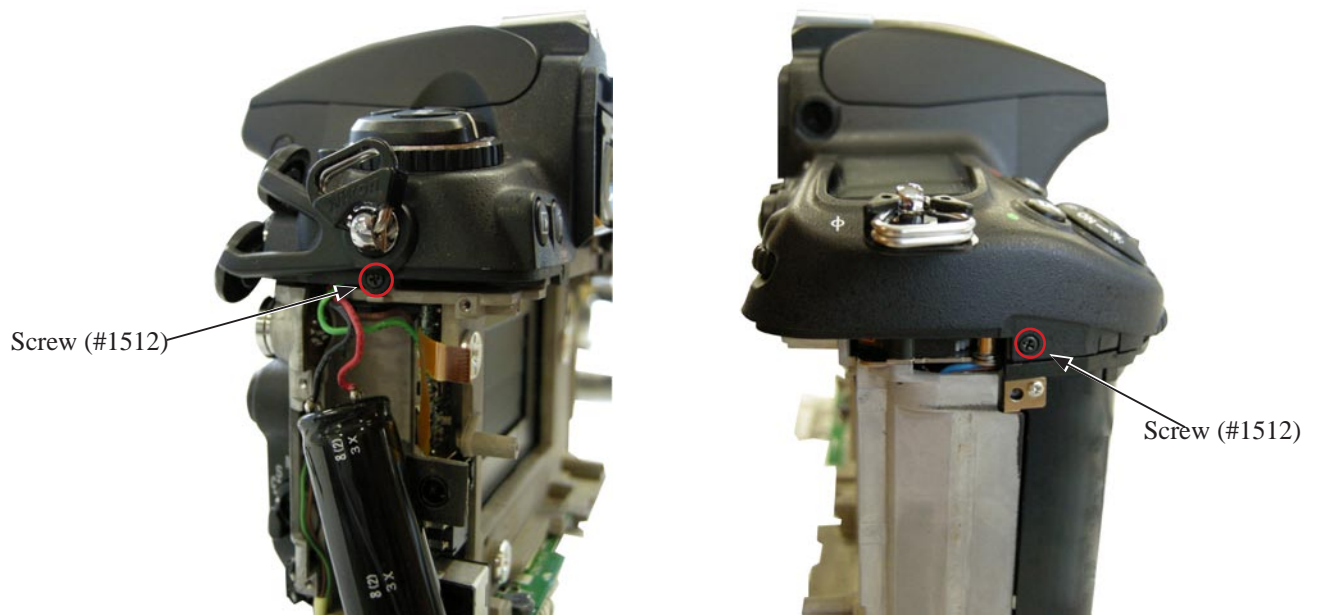

- Take out the two screws (#1511).
- Take out the screw (#1512).

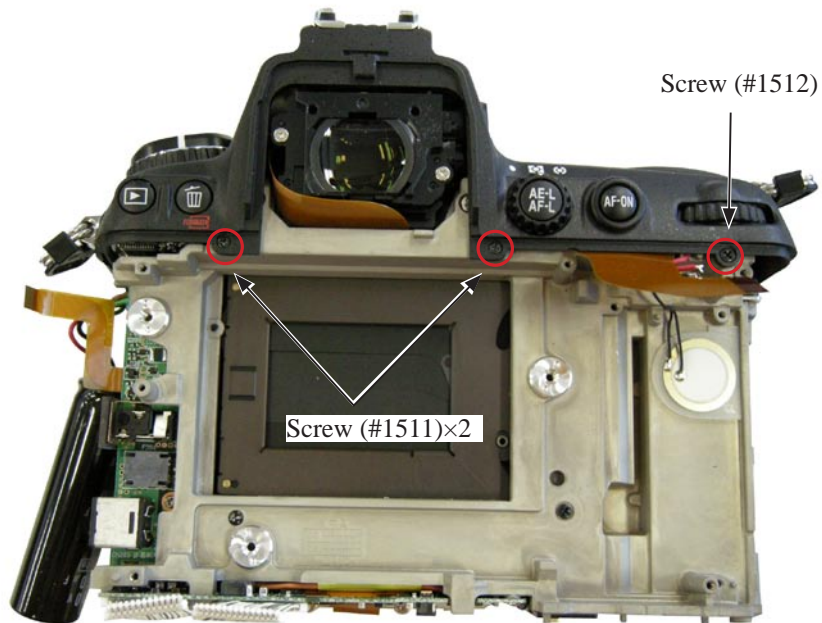

- Take out the two screws (#1509).



- Press the SB pop-up button (#40), and raise the SB (speed light).



SB pop-up button (#40)

- Take out the two screws (#1548).

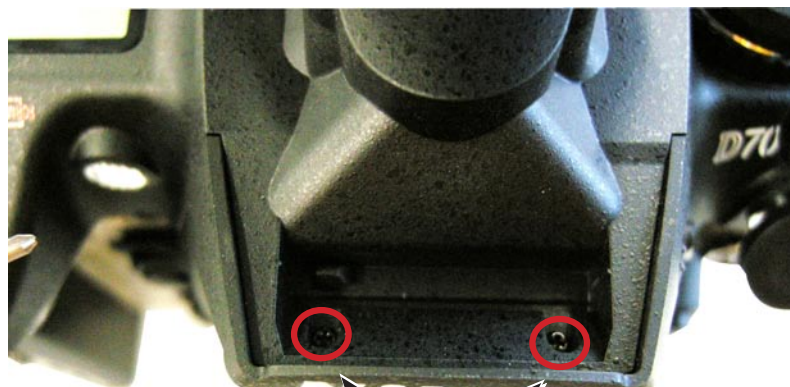

Screw (#1548)×2

- Position the top cover as below, and disconnect the FPC from the connector.
- Remove the top cover.

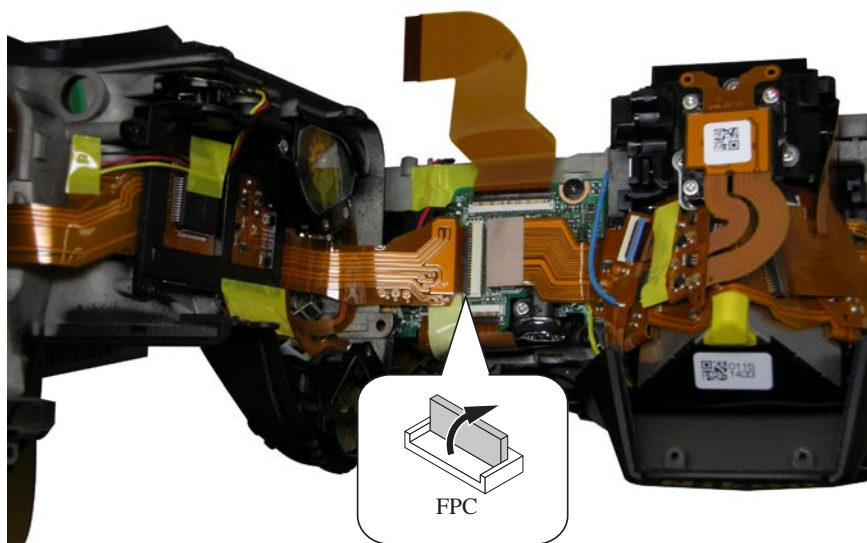
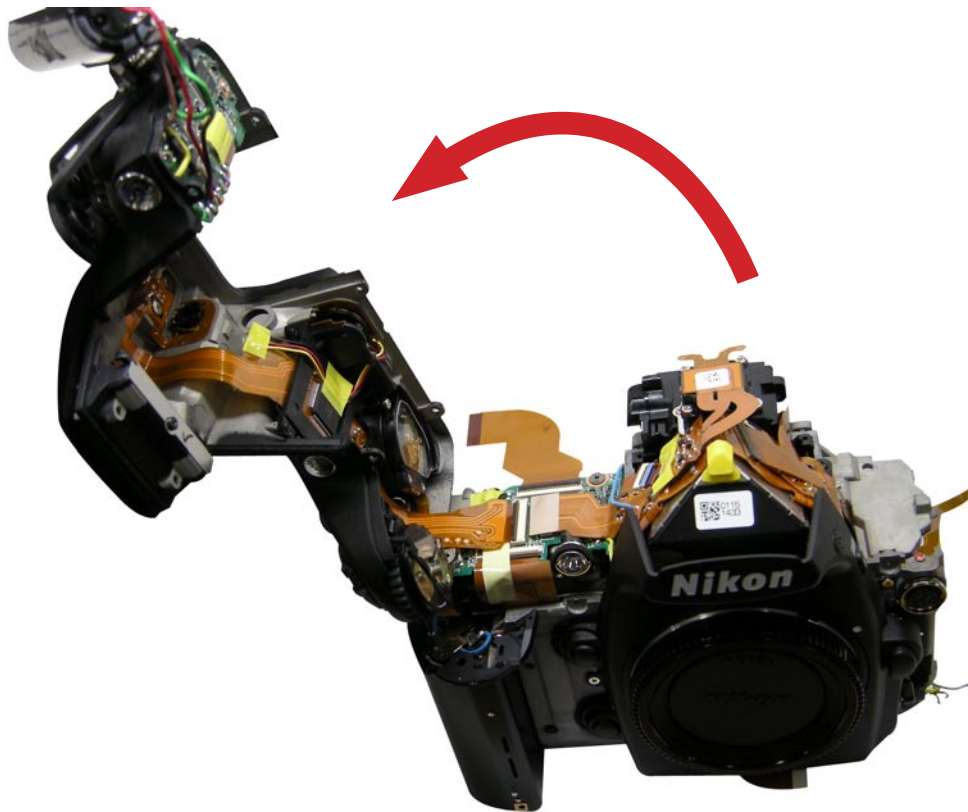

2. Top Cover

Main condenser

- Unsolder the wires ([Black][Red]) of the main condenser (#5067).

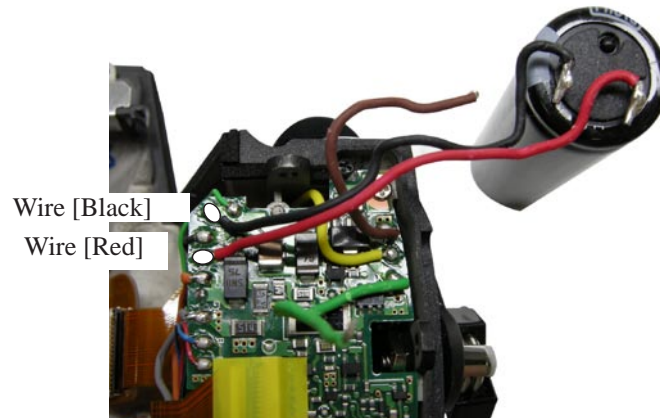

CD unit

- Peel off the tape [#TA-0005 (10×20)].
- Unsolder the top cover-FPC (#5003) and release sw FPC (#5033).

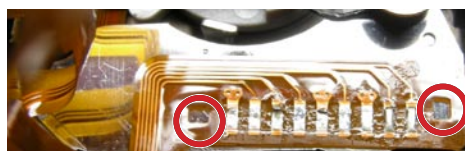
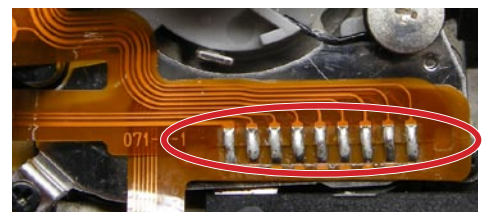
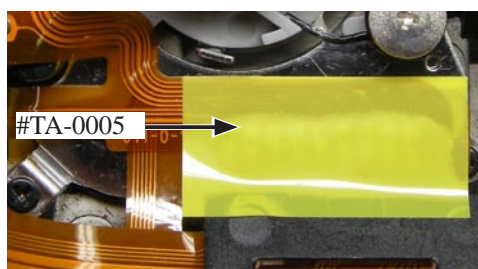

- Unsolder at three places.



- Take out the two screws (#1571), and remove the rear-CD unit (#B726).
- Take out the two screws (#1544), and remove the Sub Command Dial Unit (#B725).

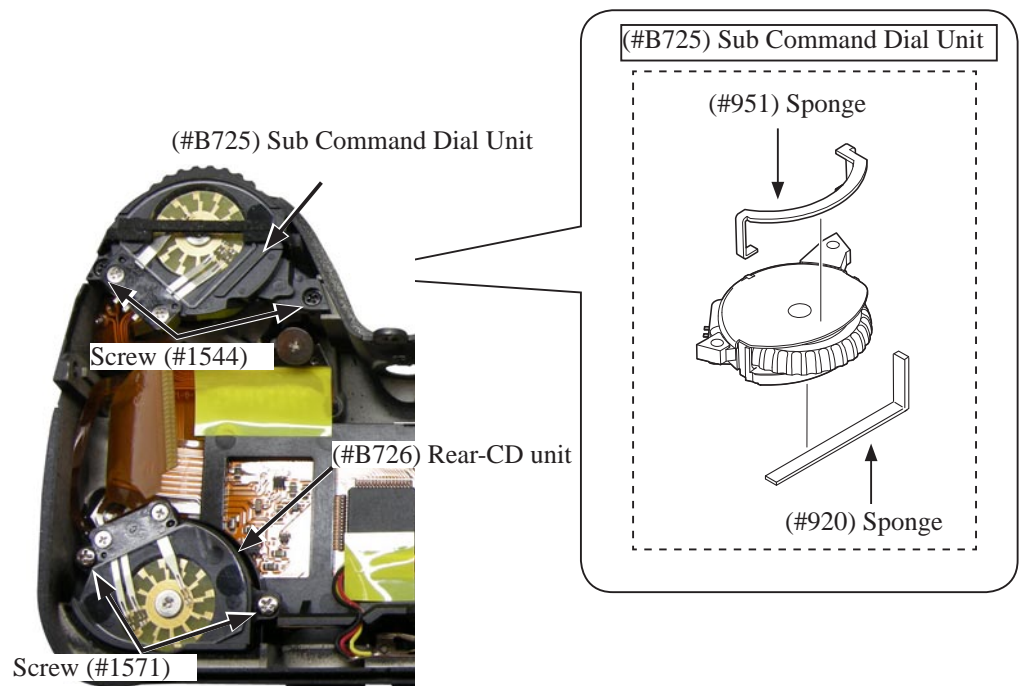

SB-PCB unit

- Peel off the tape (#929) from the two places.
- Remove the wires from the cutout section.

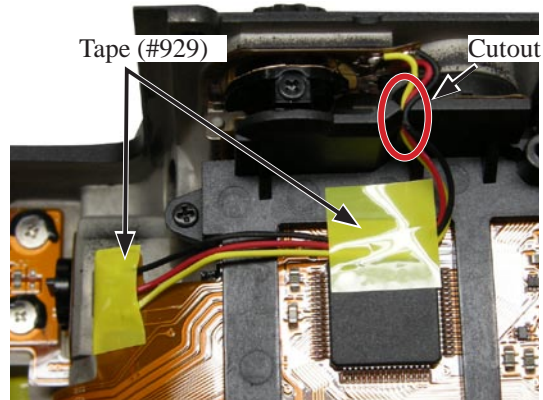

- Unsolder the wires ([Black][Red][Yellow]) of the metering mode-FPC.

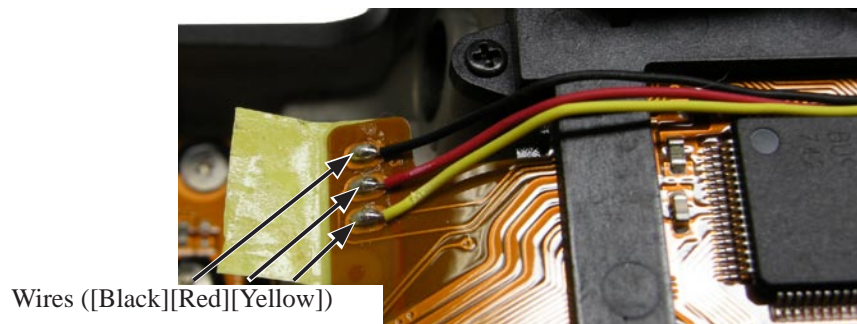

- Peel off the tape (#929).

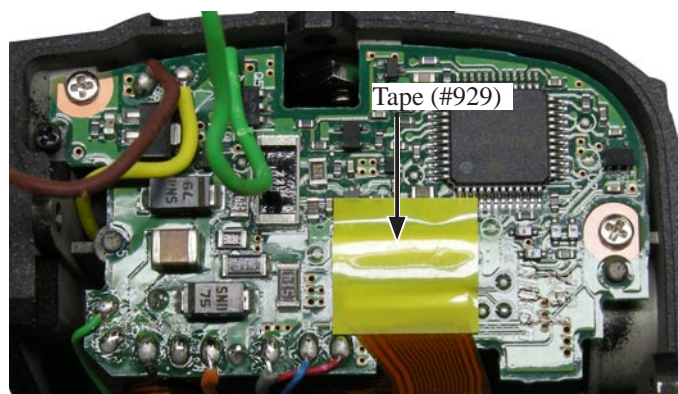

- Unsolder the wires ([Yellow][Green][Black][Orange][Gray][Blue][Red]).
- Disconnect the FPC form the connector.
- Take out the two screws (#1541), and remove the SB-PCB unit (#5013).

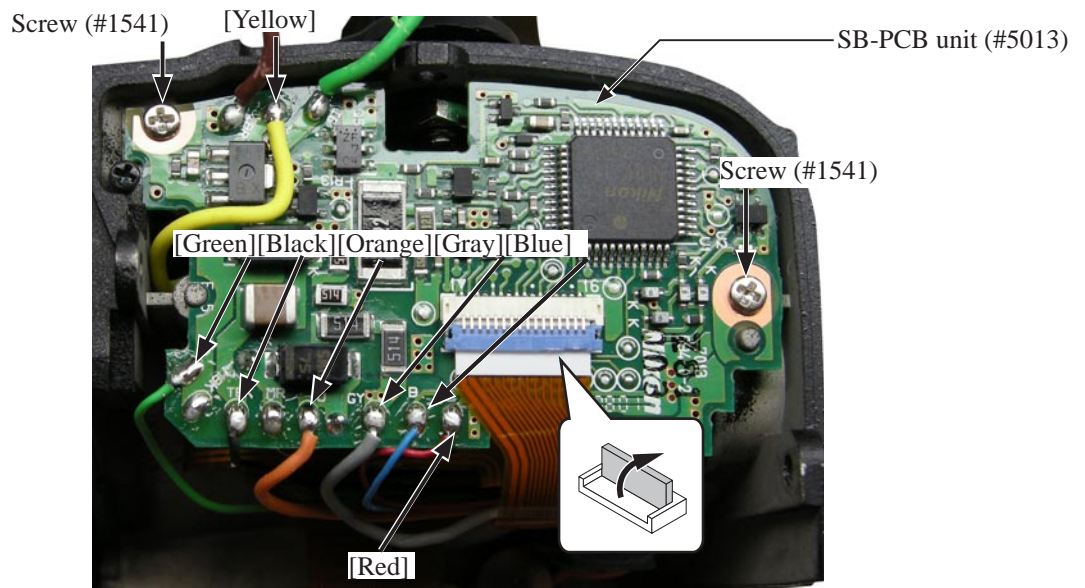

Release-SW

- Peel off the tape (#949).
- Take out the screw (#1605).

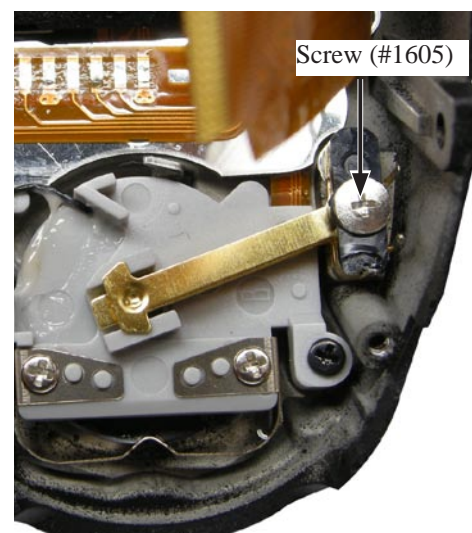
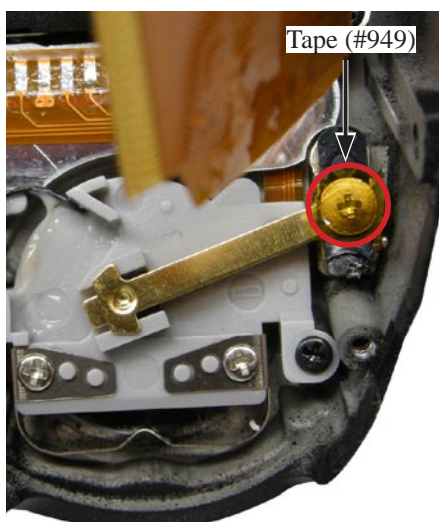

- Remove the release-SW unit (#B735).

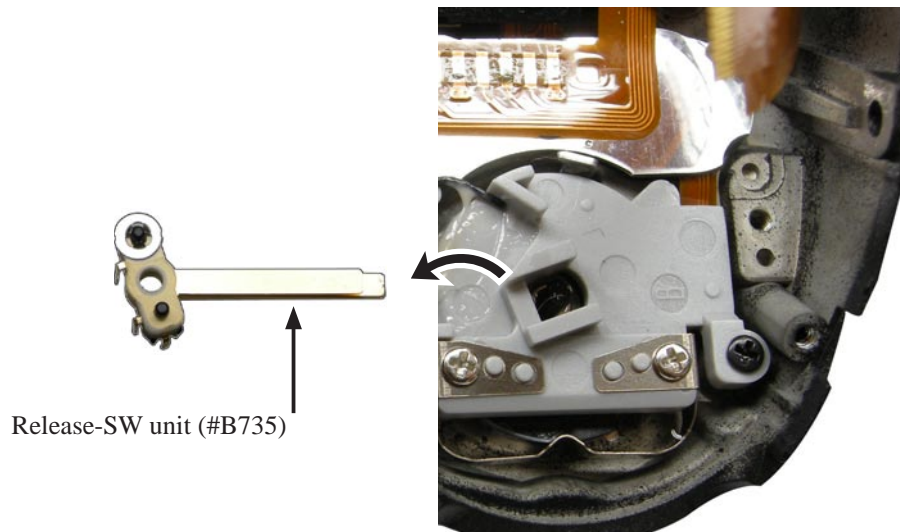

SB

- Take out the two screws (#796), and remove the two SB pop-up arms (#322).
- Take out the two screws (#1623), and remove the SB upper cover (#301).



- Take out the screw (#1601).
- Pull the wires outside.

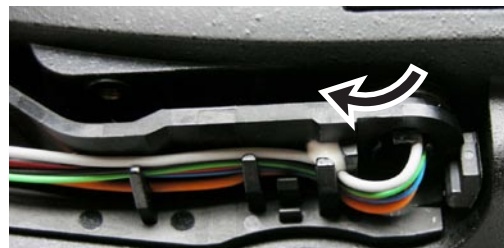
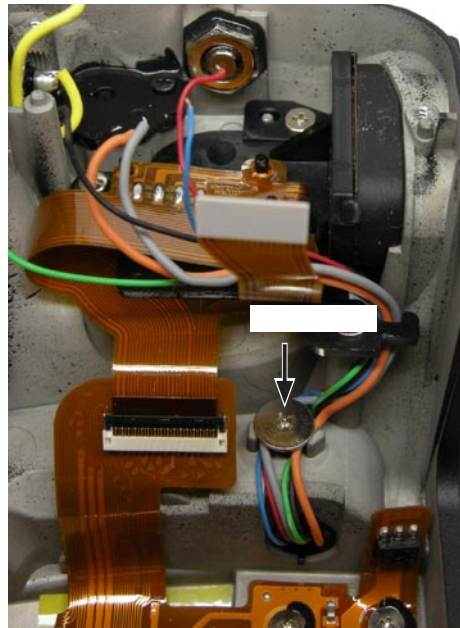

- Take out the screw (#1601) and remove the spring (#305), [using caution to avoid popping out of the spring.]

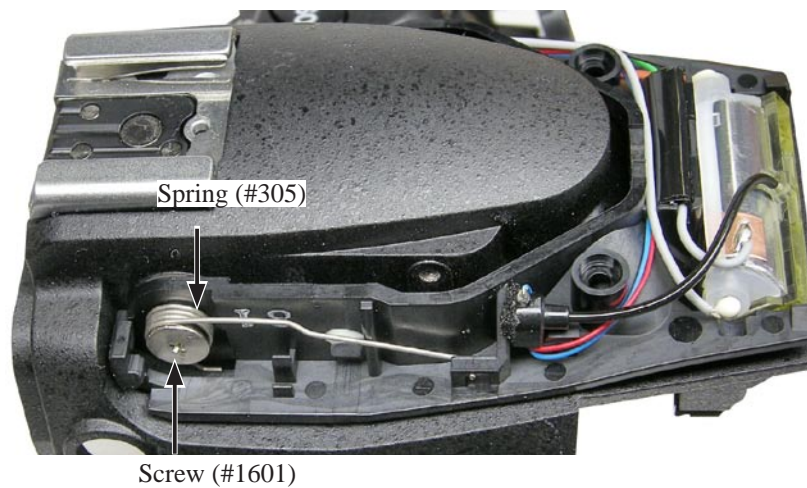

- Remove the collar (#B306), (using caution to avoid bending the brush).



- Remove the collar (#308).
- Remove the collar (#307).
- Remove the SB lower case unit (#B302).



Top cover FPC unit

- Disconnect the FPC from the connector.

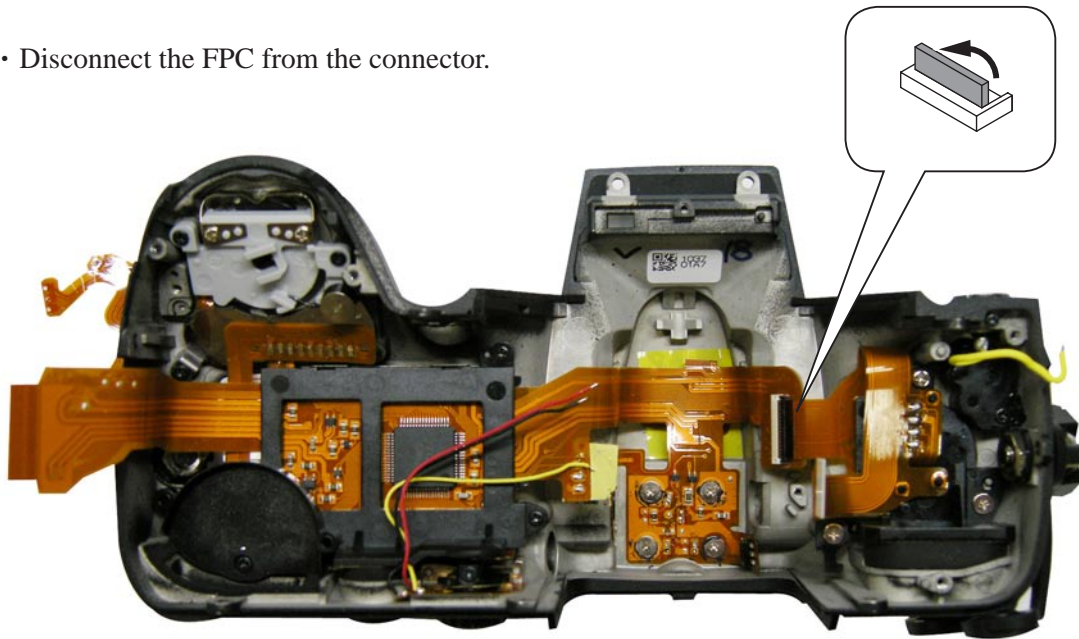

- Remove the super X.
- Take out the four screws (#321).
- Unsolder at four places.

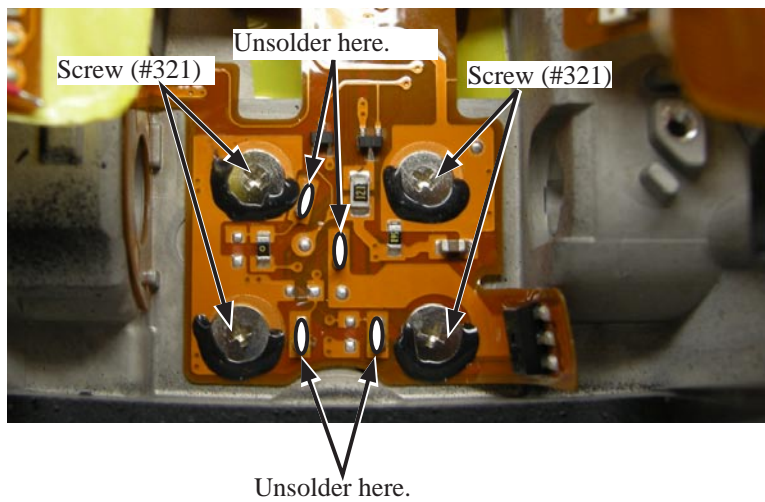

- Remove the shoe mold unit (#B317), hot shoe (#316) and hot shoe spring (#318).

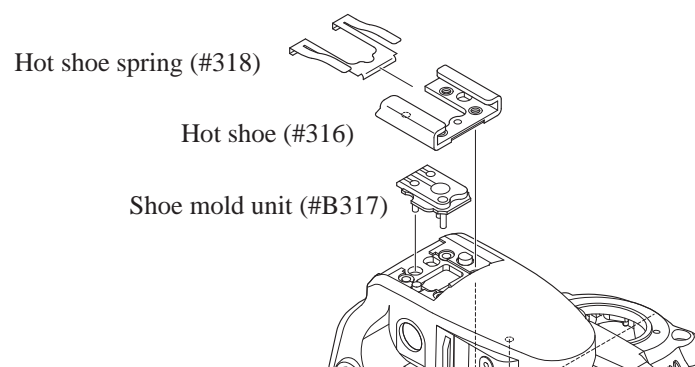

- Peel off the top cover-FPC (#5003).

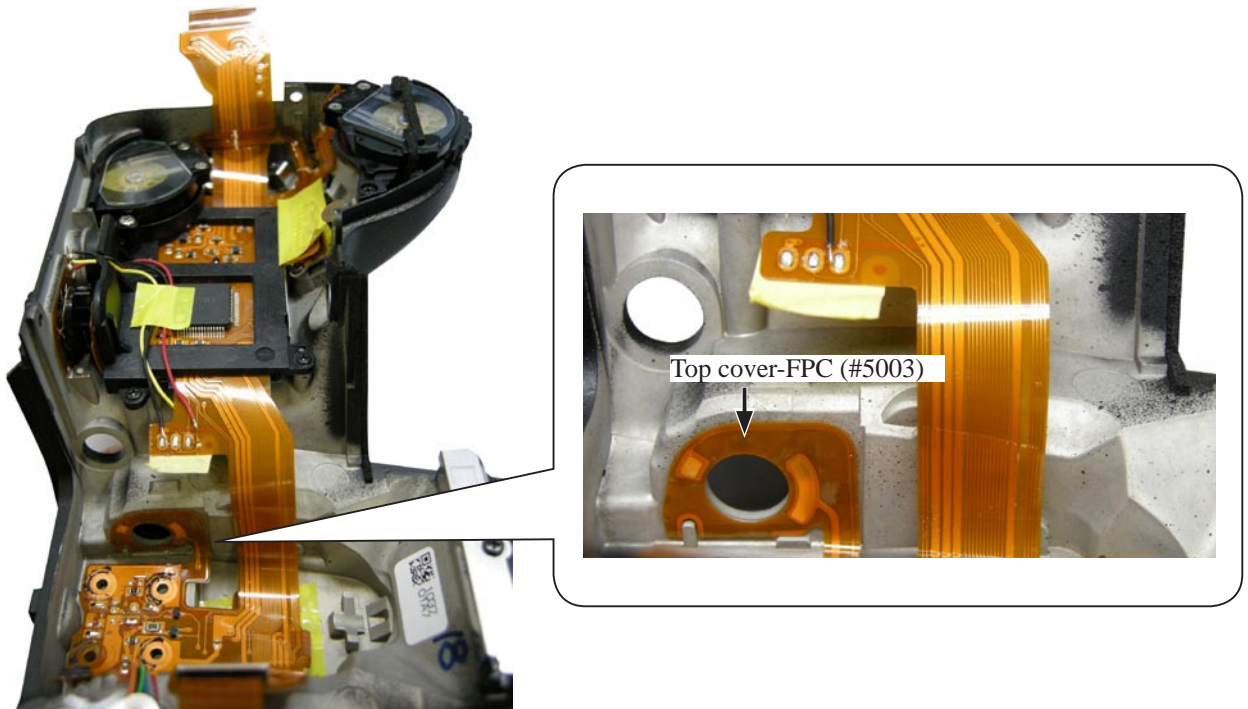

- Take out the screw (#1606) and remove the spring (#750), (using caution to avoid popping out of the spring.)
- Peel off the top cover-FPC (#5003) from the support plate (#731).

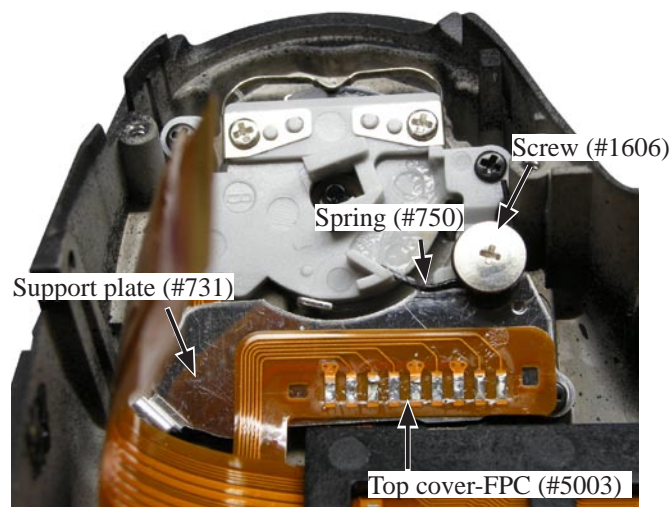

- Take out the screw (#1560).
- Take out the two screws (#1540).

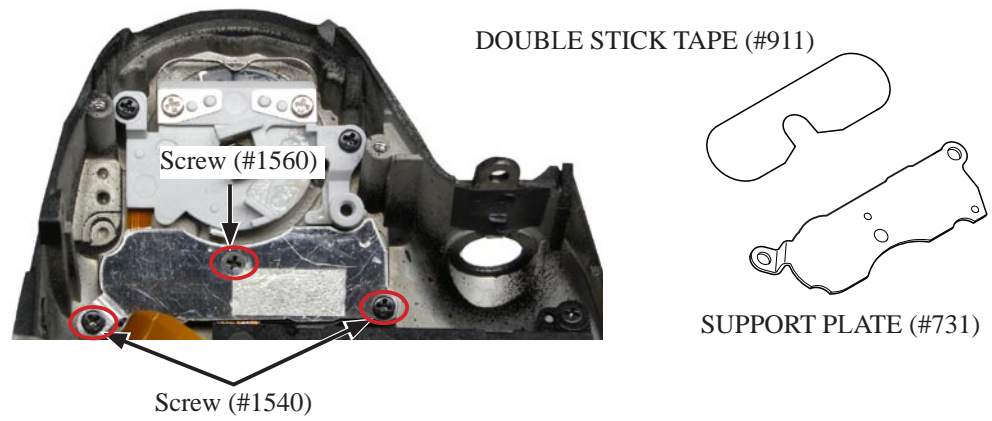

- Take out the three screws (#1544).
- Take out the two screws (#1549).

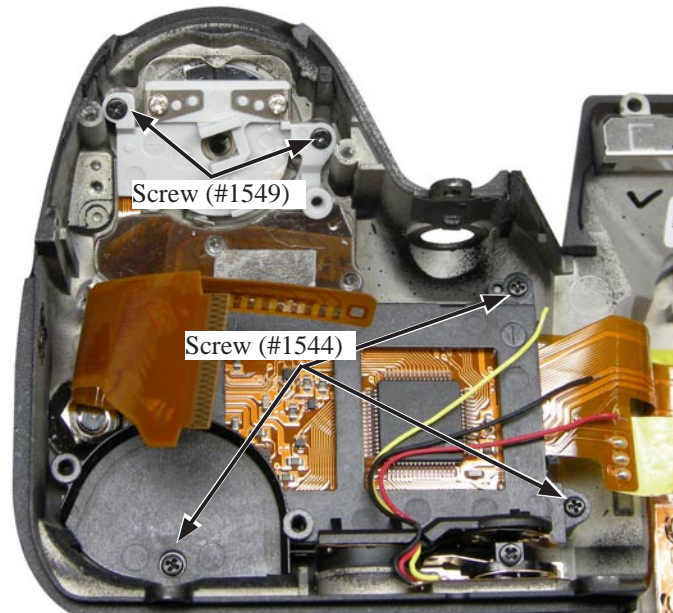

- Remove the top cover-FPC (#5003).

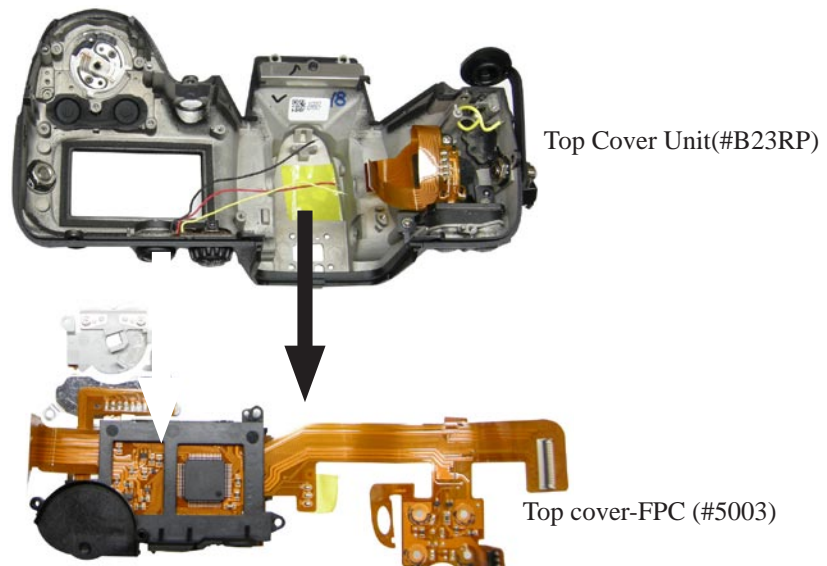

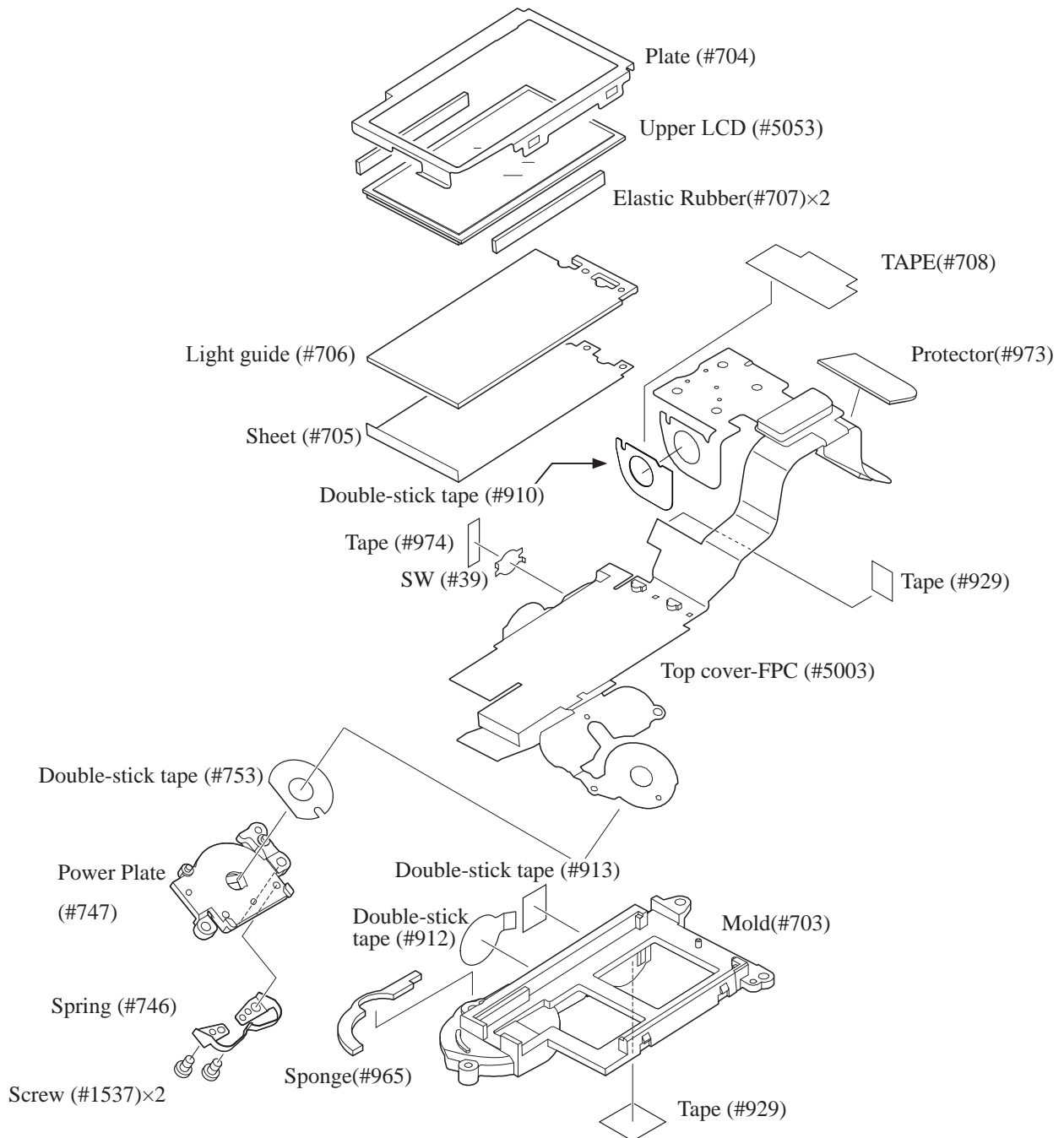

Main SW

- Remove the conducting button (#787).

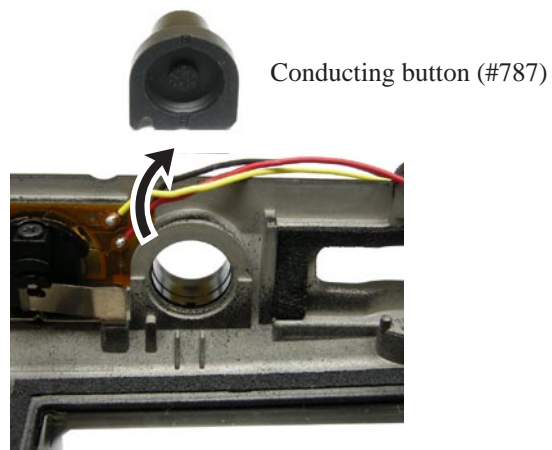

- Remove the Conducting Button (#730), (using caution with applied Super X.)

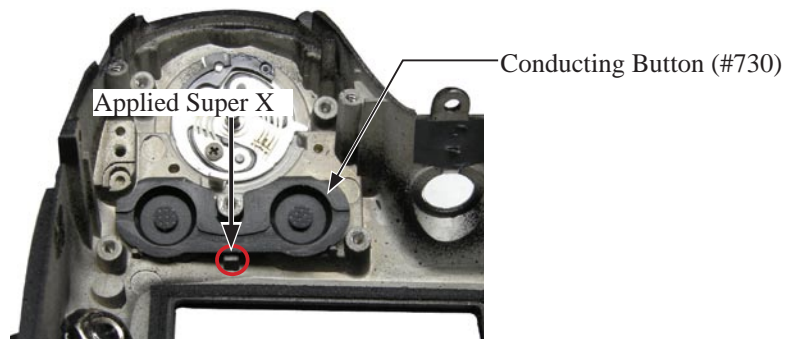

- Take out the screw (#1648).
- Remove the metering mode dial unit (inside) (#B782), AE mode dial (#781), and AE-lock button (#780).
- Remove the spring (#784), (using caution to avoid popping out of it).

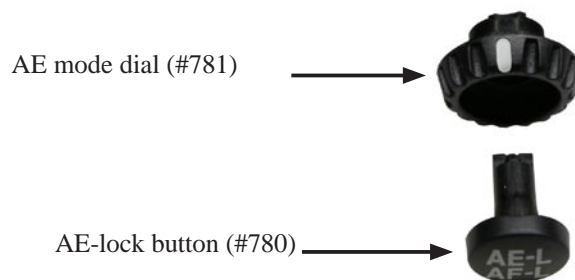
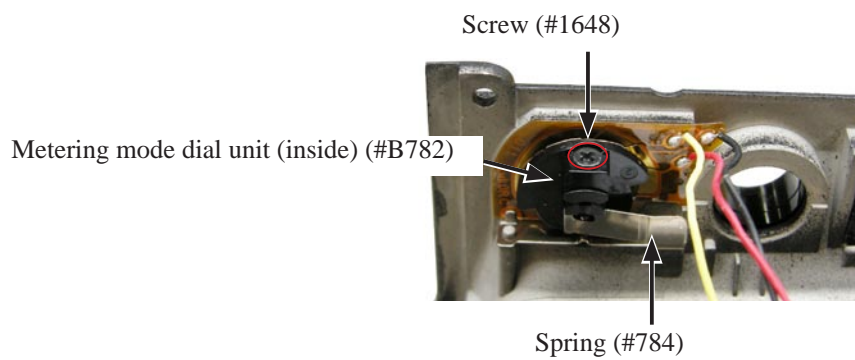

- Remove the metering mode FPC (#5028).

Metering mode FPC (#5028)

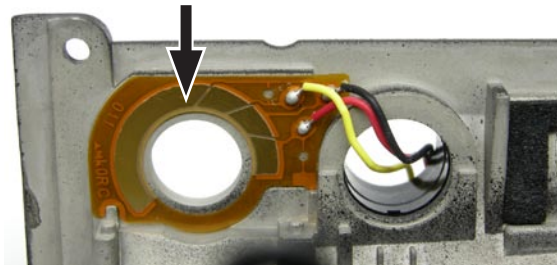

- Take out the screw (#1608), and remove the two ON-OFF SW brushes (#748).

ON-OFF SW brush (#748)

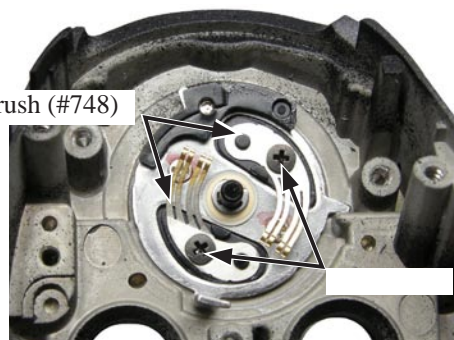

- Remove the E-ring (#1652), and then the Washer (#744), (using caution to avoid popping out of the washer).

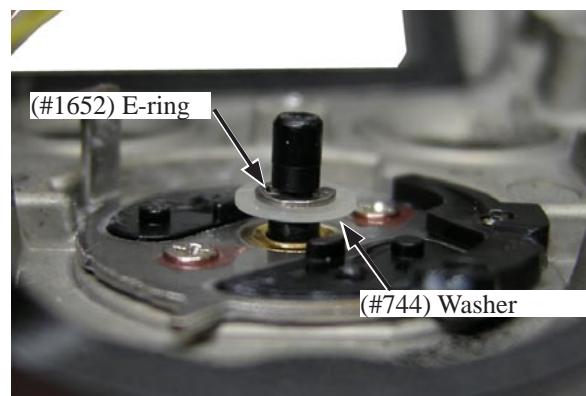

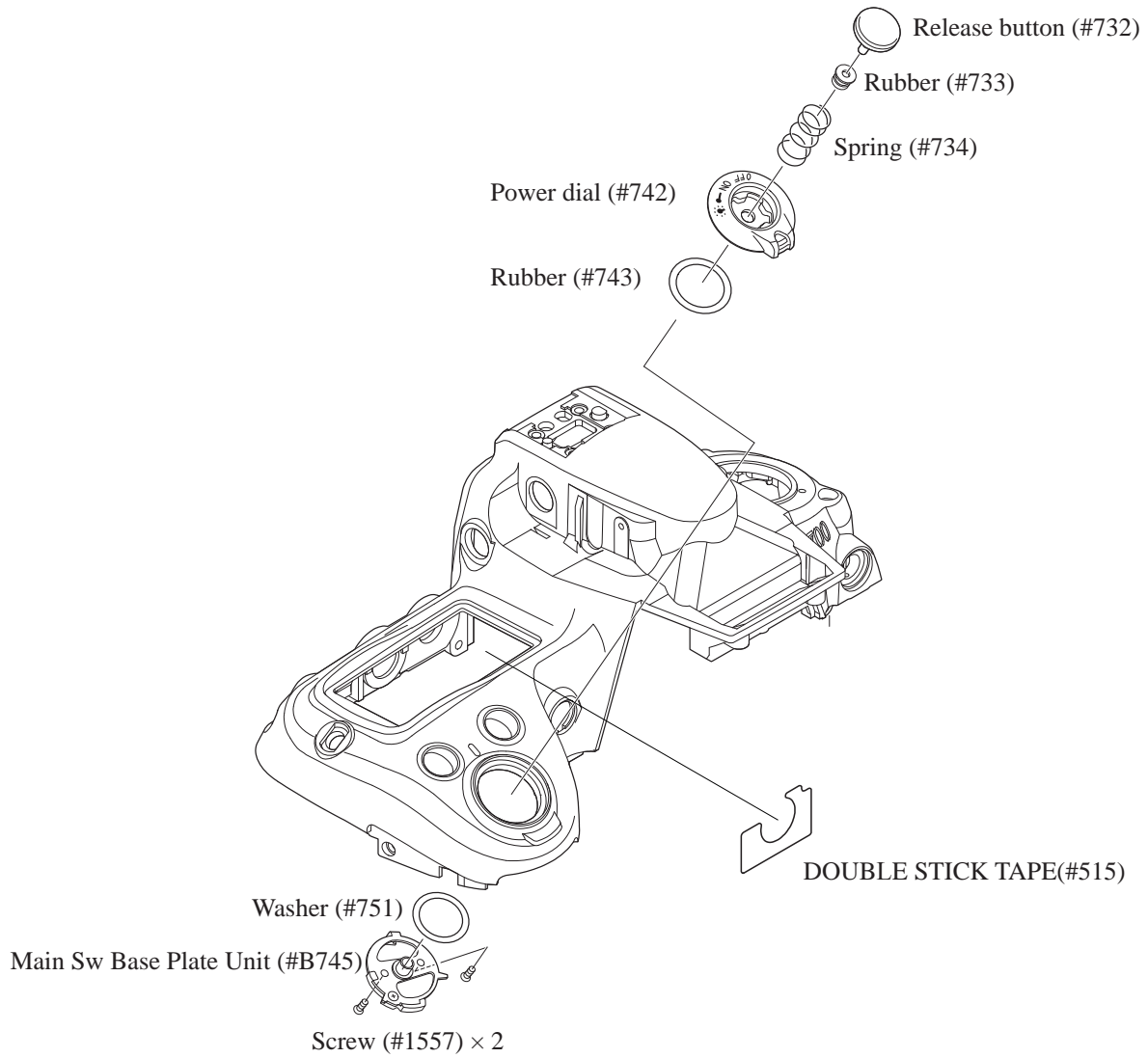

- Take out the screw (#1565), and remove the Plate (#312).
- Remove the spring (#310), (using caution to avoid popping out of it).
- Remove the SB Lock Lever(#309)

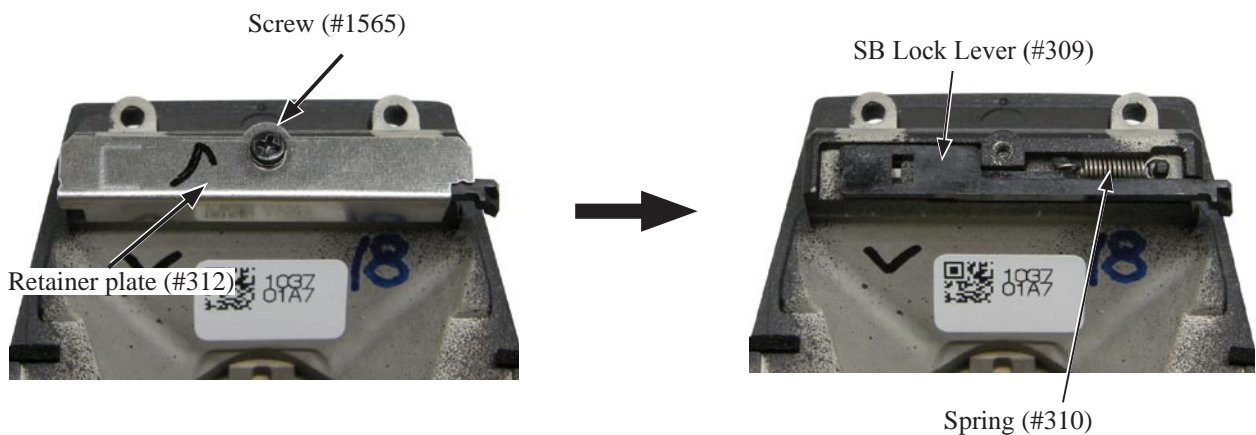

Mode dial

- Unsolder the mode dial FPC (#5025) and trefoil FPC (#5026).

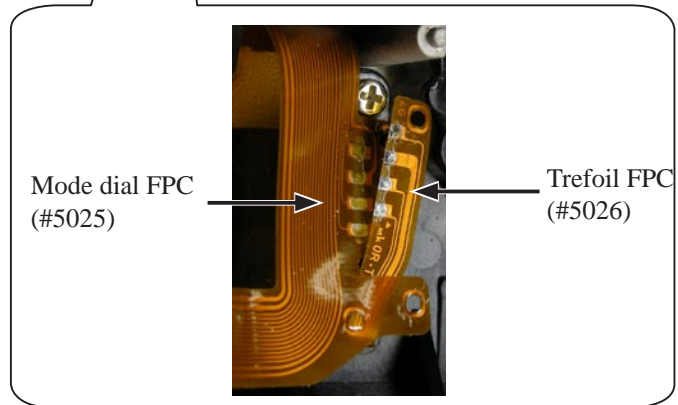
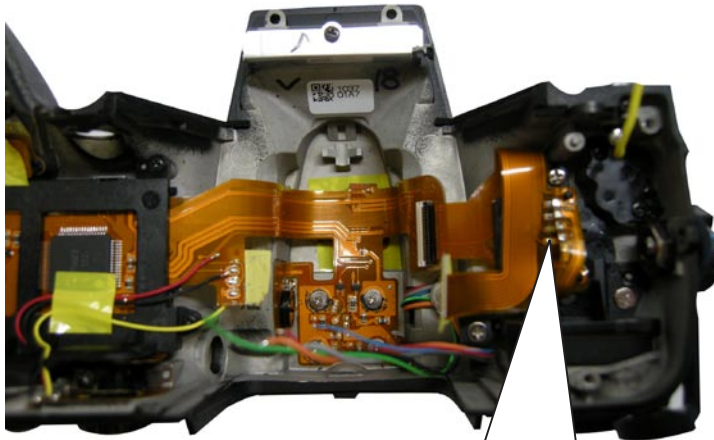

- Take out the screw (#1574).

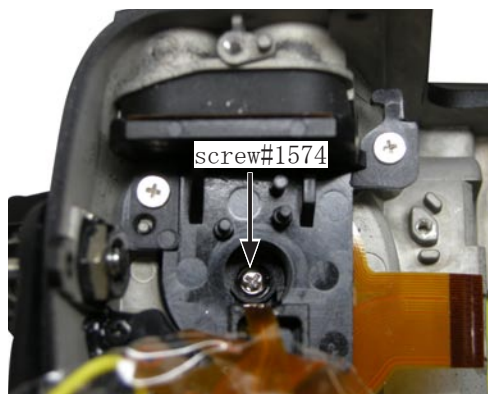

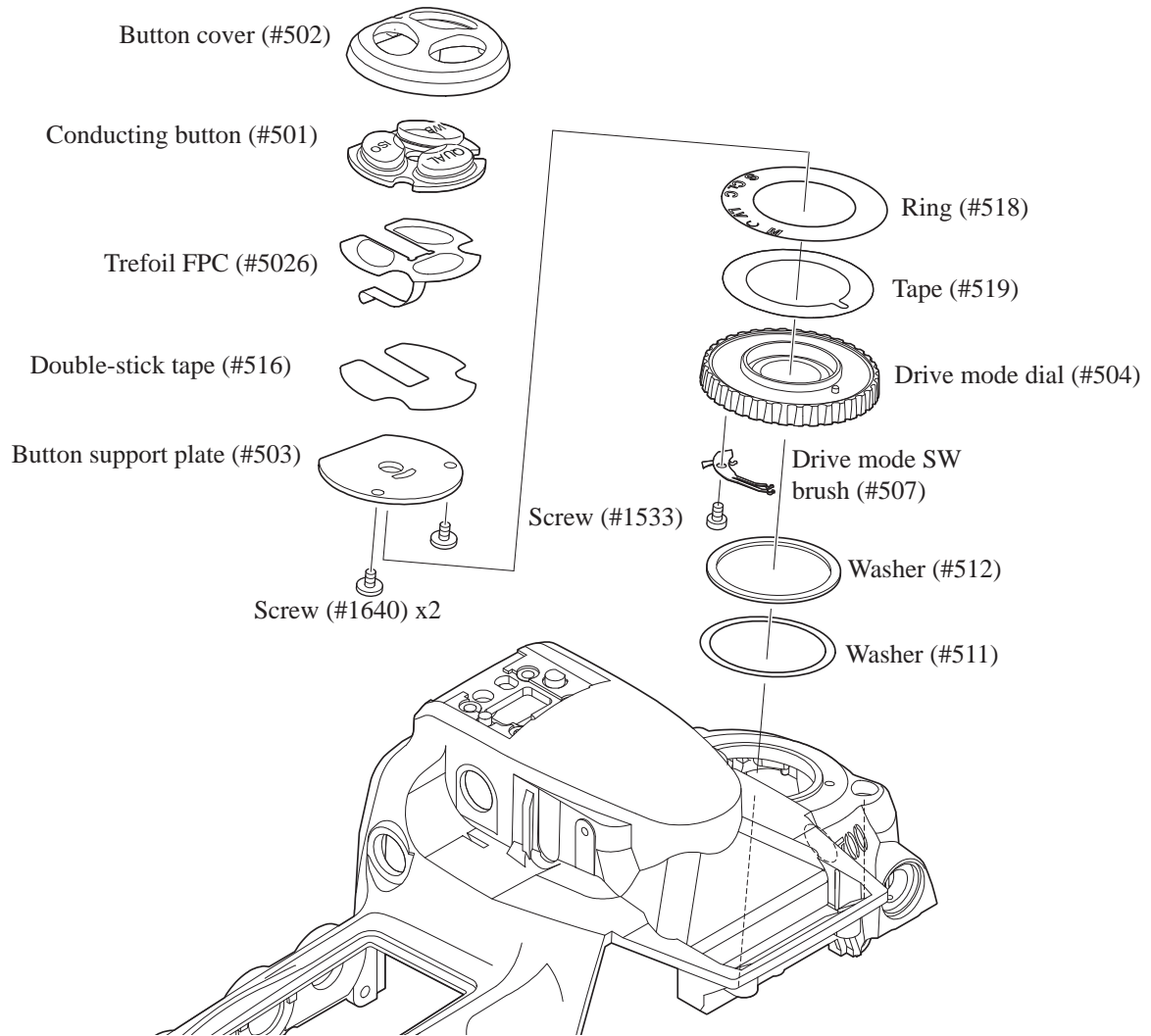

• Take out the screw (#1571) and the two screws (#1609), and remove the base plate (#505).

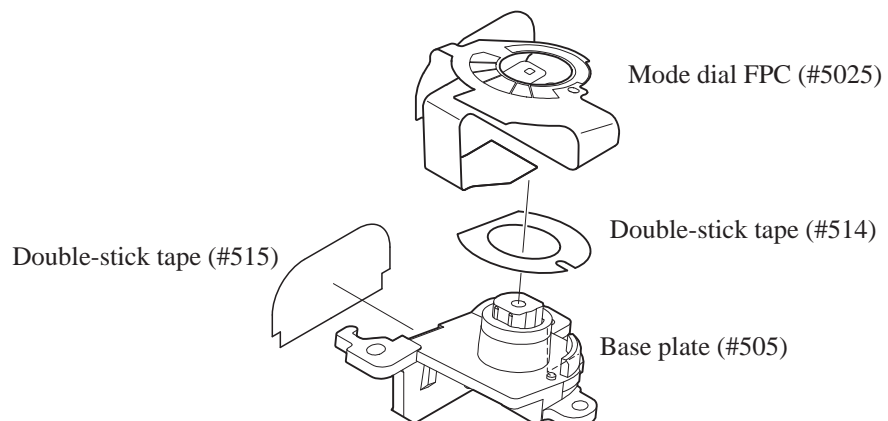
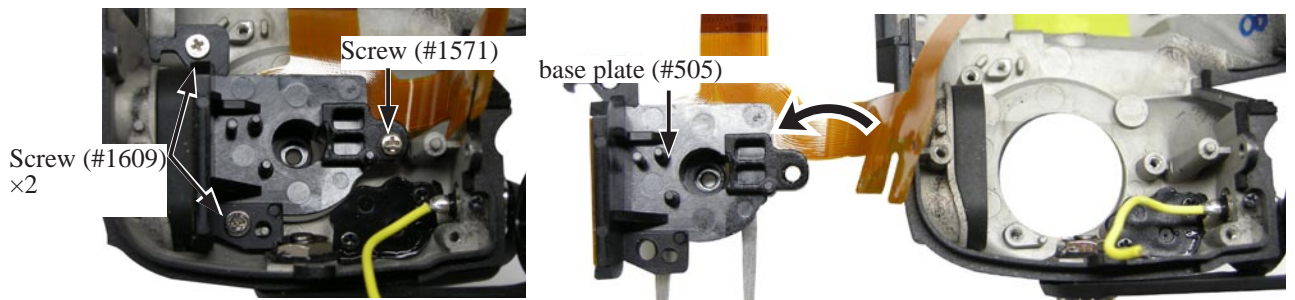

Top cover external parts

- Remove the Conducting Button (#513).

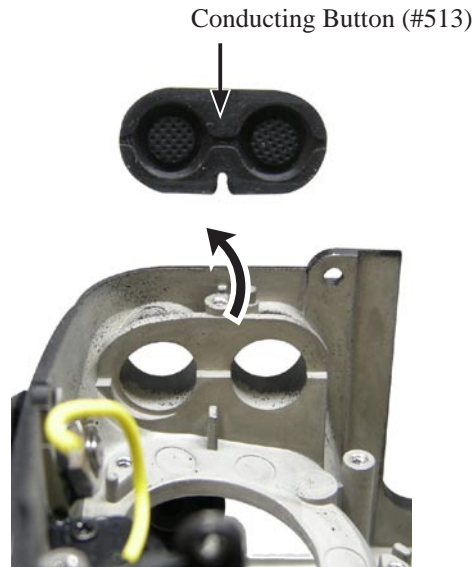

- Take out the screw (#1532), and remove the sync terminal (#50).

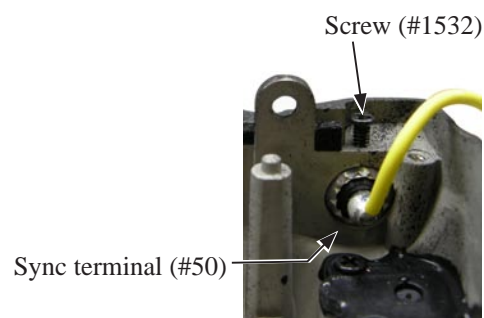

- Remove the super X around the mold (#510).

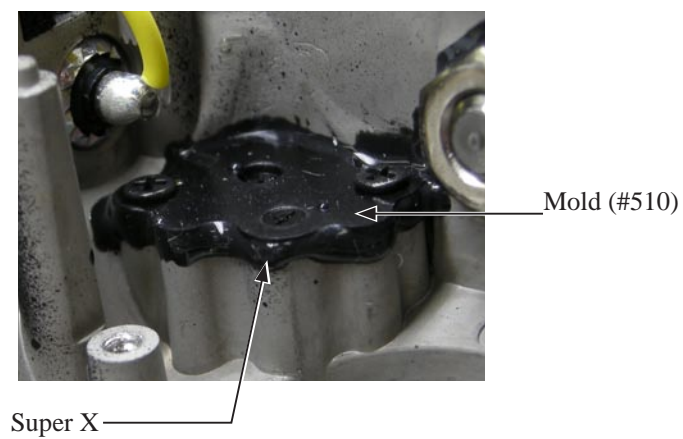

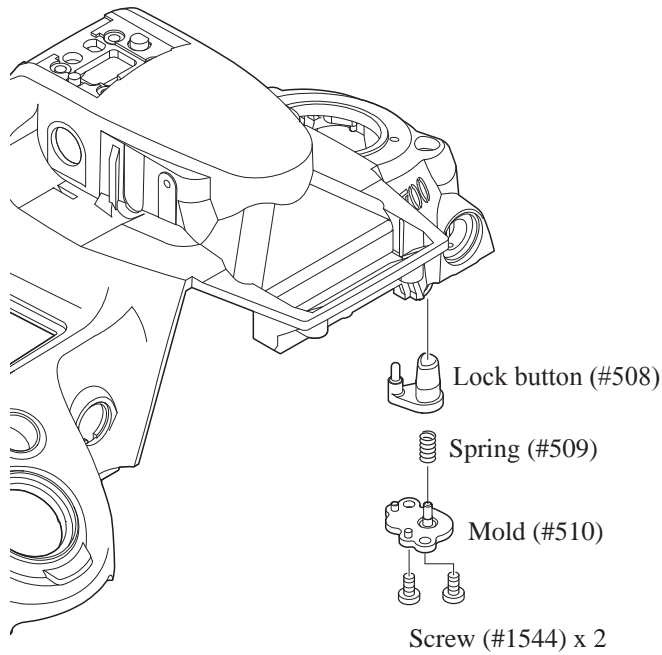

- Remove the tape (#972).

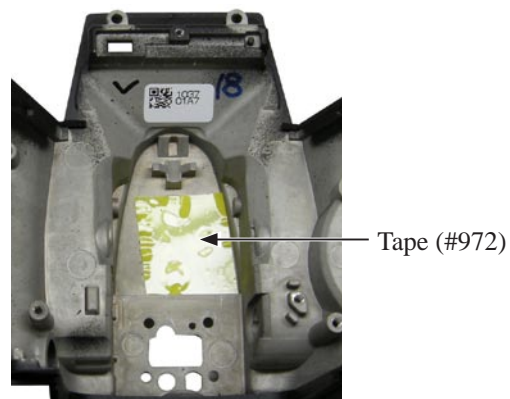

- Peel off the tape (#709).
- Remove the super X from the AF-assist lamp protector (#327).
- Remove the AF-assist lamp protector (#327).

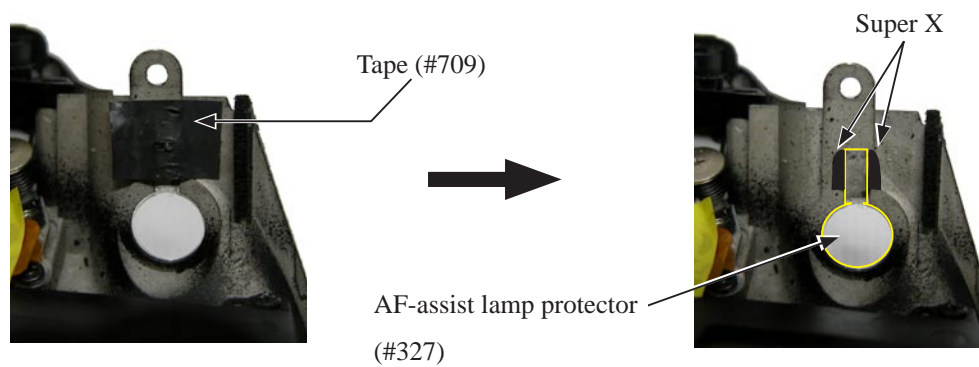

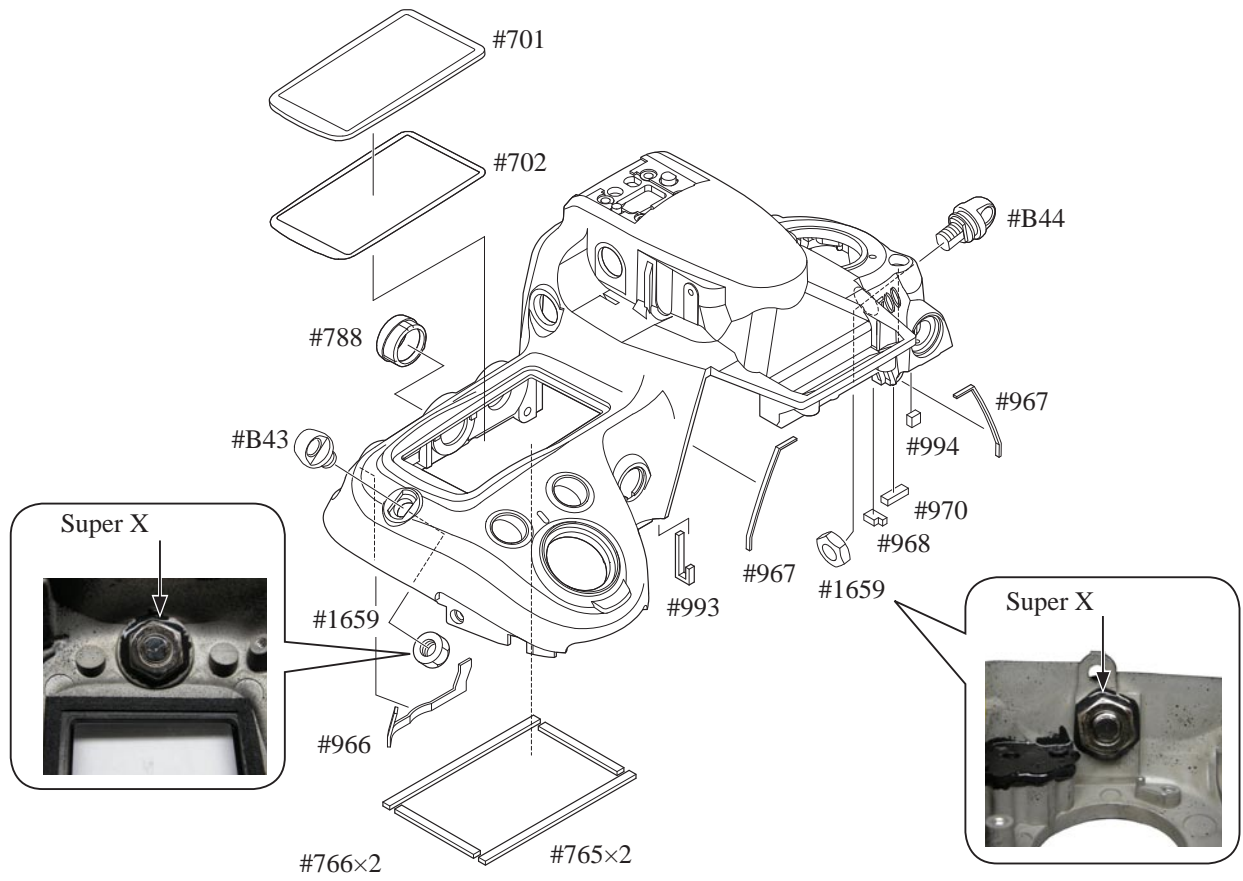

3. Separation of Front body from Rear body

DC/DC PCB

- Peel off the tape [#TA-0005 (10×3.7)].

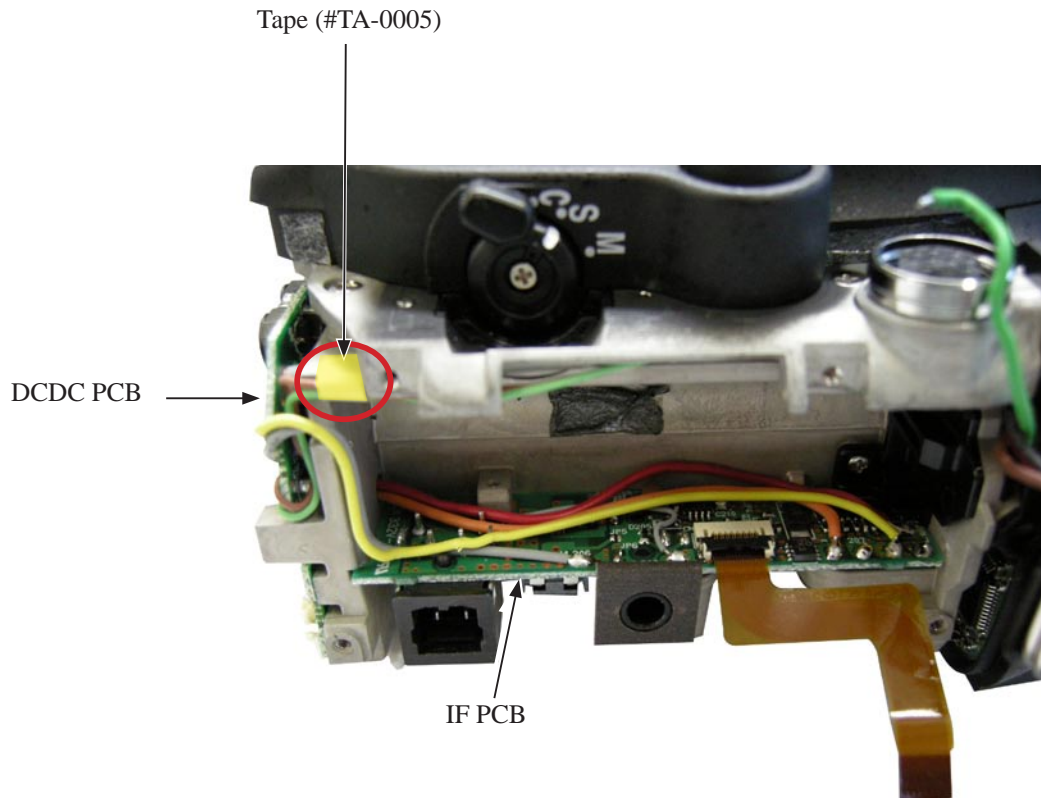

- Unsolder the wires ([Gray][Orange][Red]).

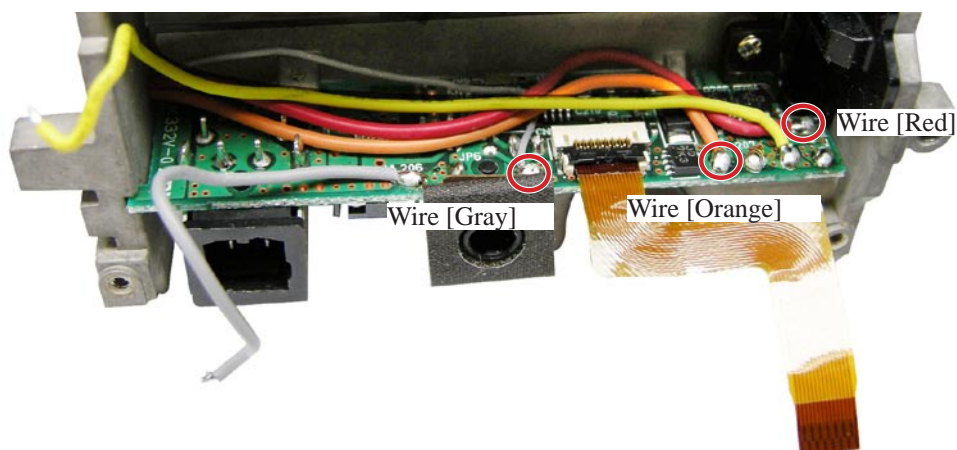

- Unsolder at eight places.
- Remove the FPC.

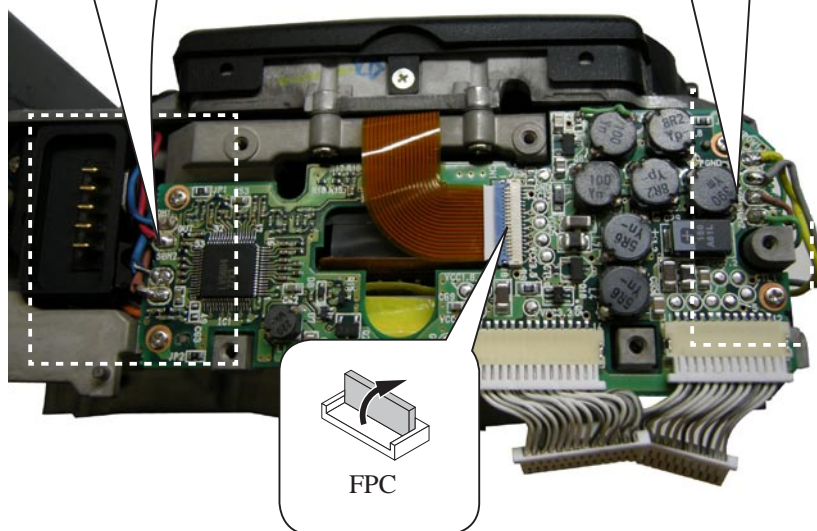
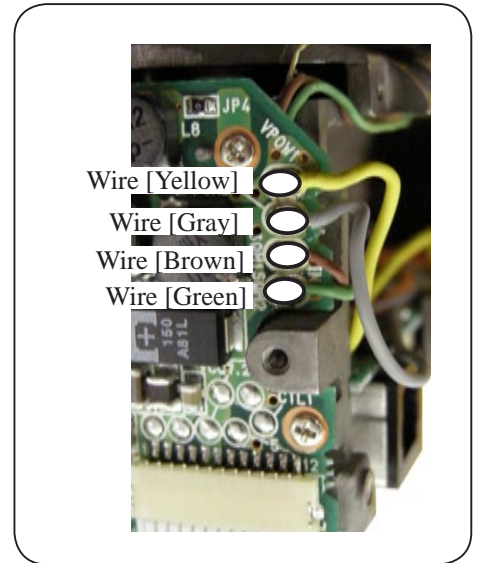
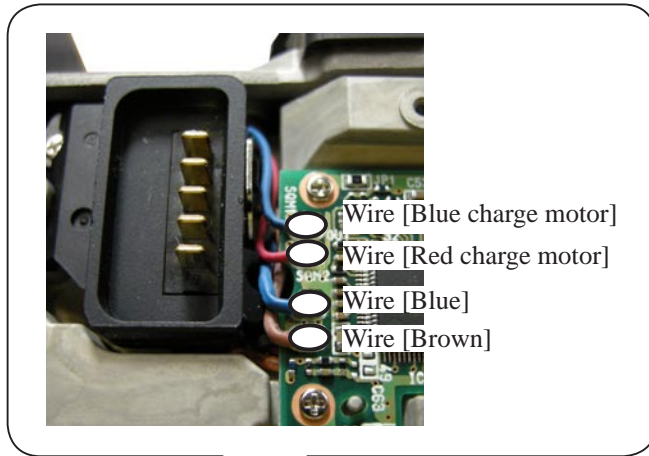

- Take out the four screws (#1509).
- Remove the DC/DC PCB (#5047).



- Remove the harness (#5071).
- Remove the harness (#5070).

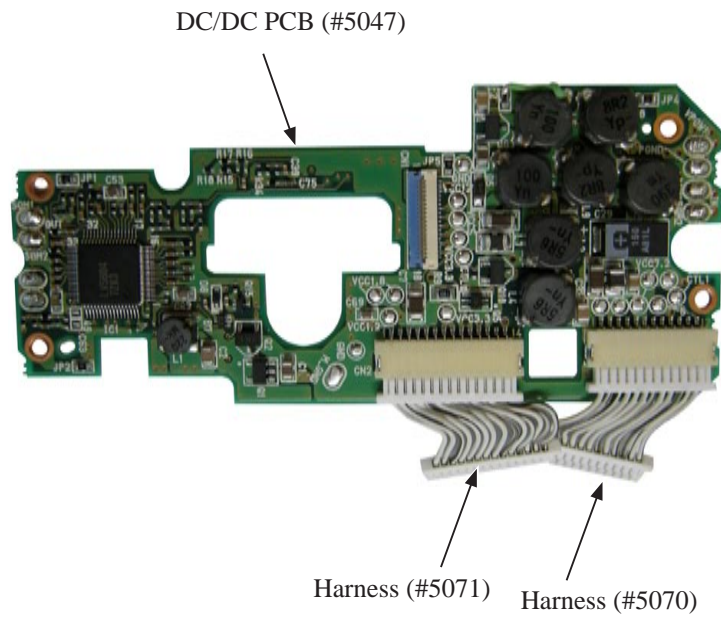

Main PCB

- Unsolder the wire [Blue] of the battery contact unit (#B822).
- Pull this wire[Blue] of the battery contact unit (#B822) out from the gap between the main PCB and the body.

FPC of Lens contact FPC unit (#B5008)

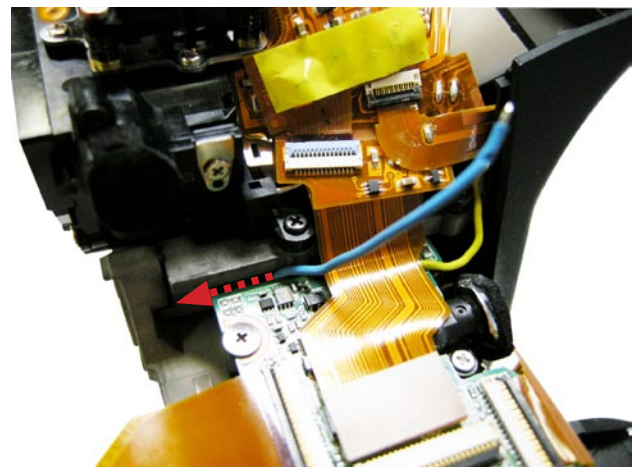
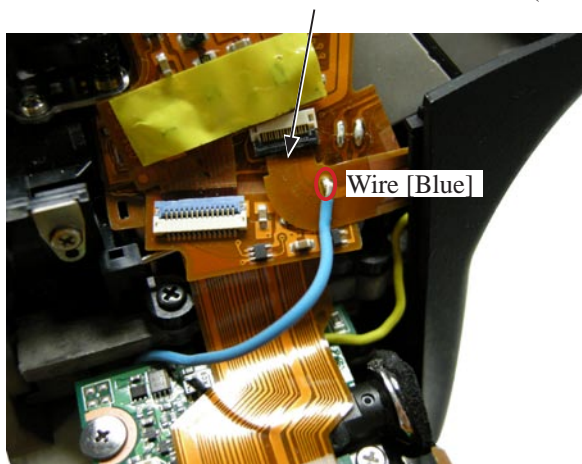

- Disconnect the penta-FPC unit (#B5005) from the connector.
- Peel off the tape [#TA-0005 (10×3.7)].

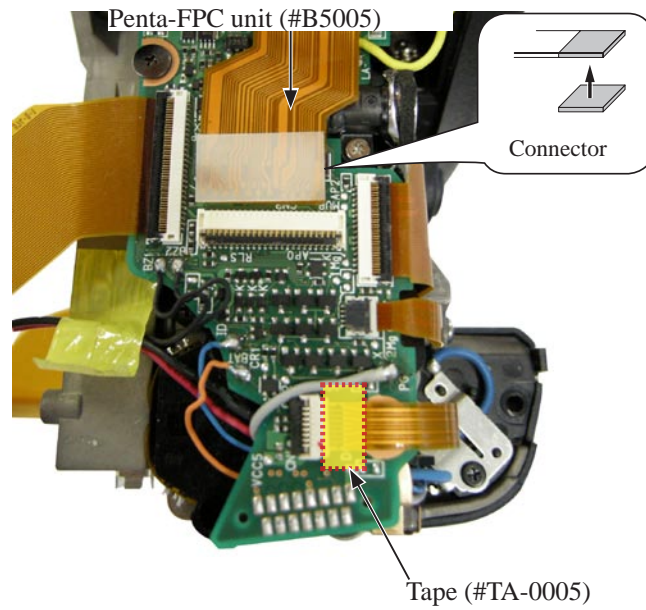

- Unsolder the eight wires.
- Disconnect the FPC at three places.

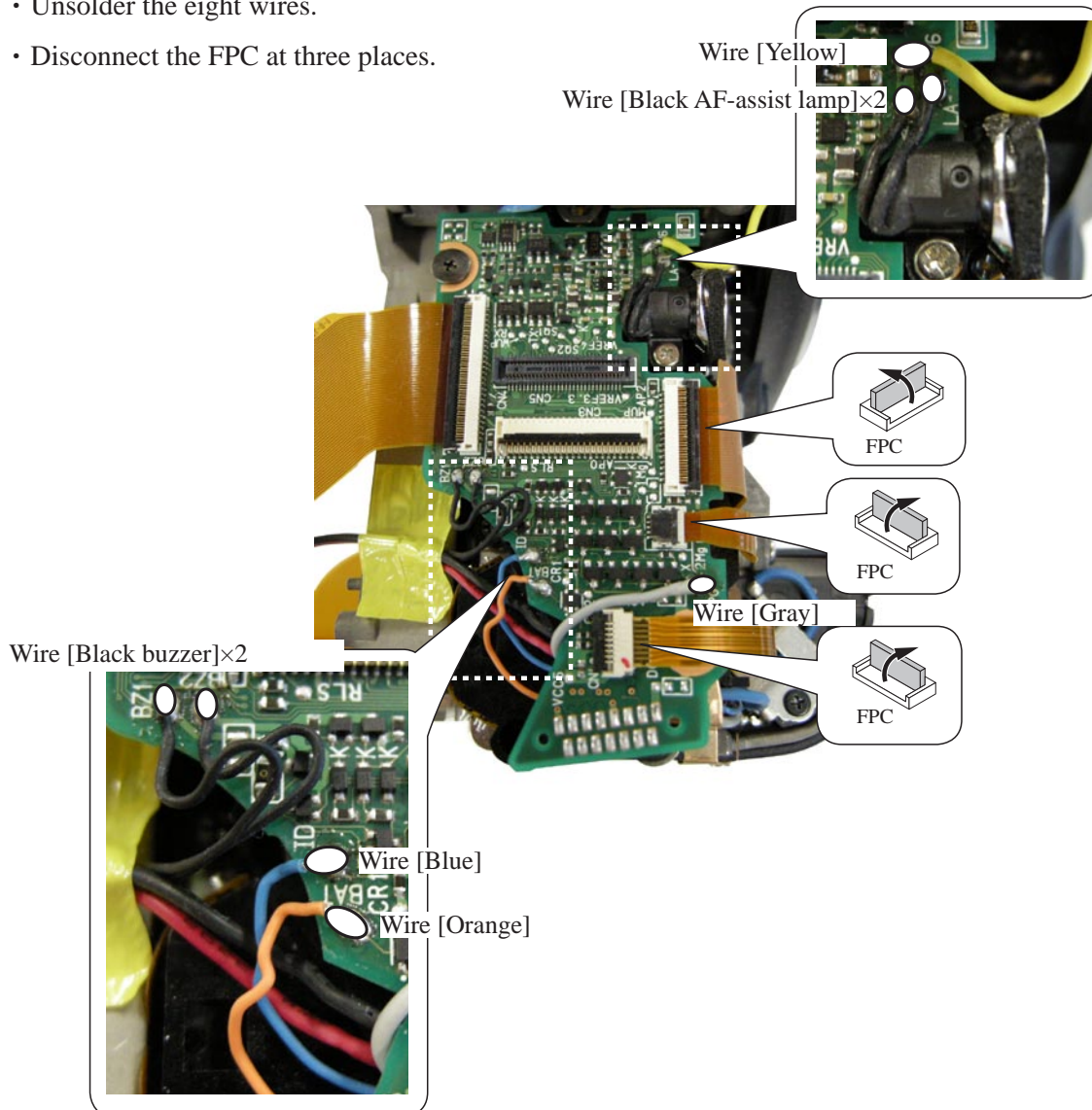

- Peel off the tape [#TA-0005 (10×20)] by half, and remove the wires ([Black][Red]).

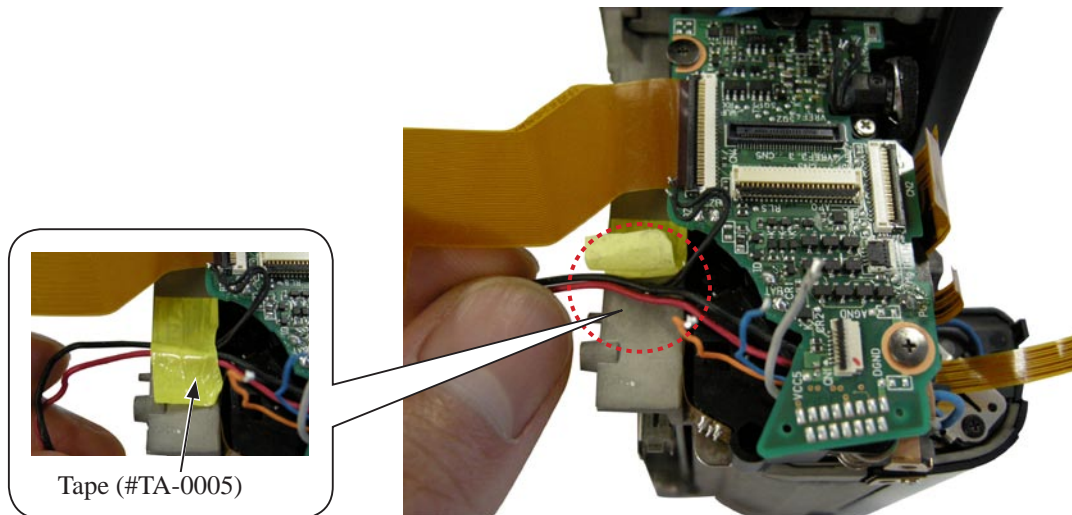

- Take out the two screws (#1616).

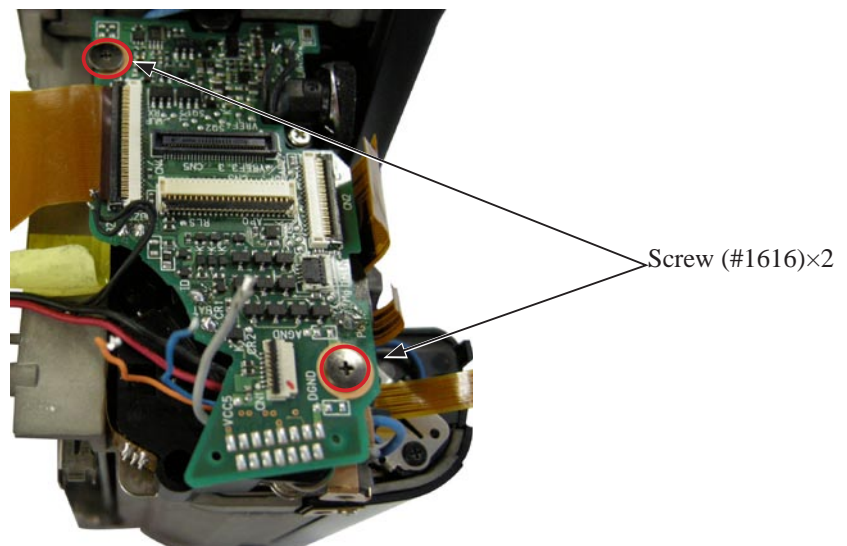

- Remove the main PCB (#5001).

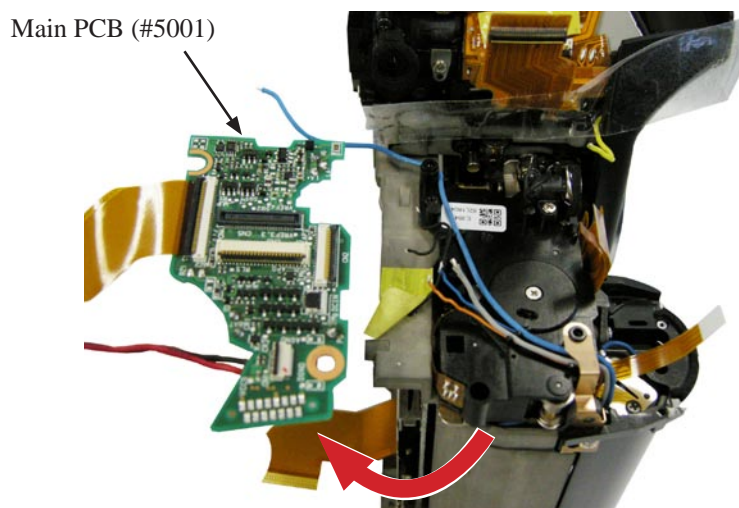

- Remove the Connection-FPC (#5039).

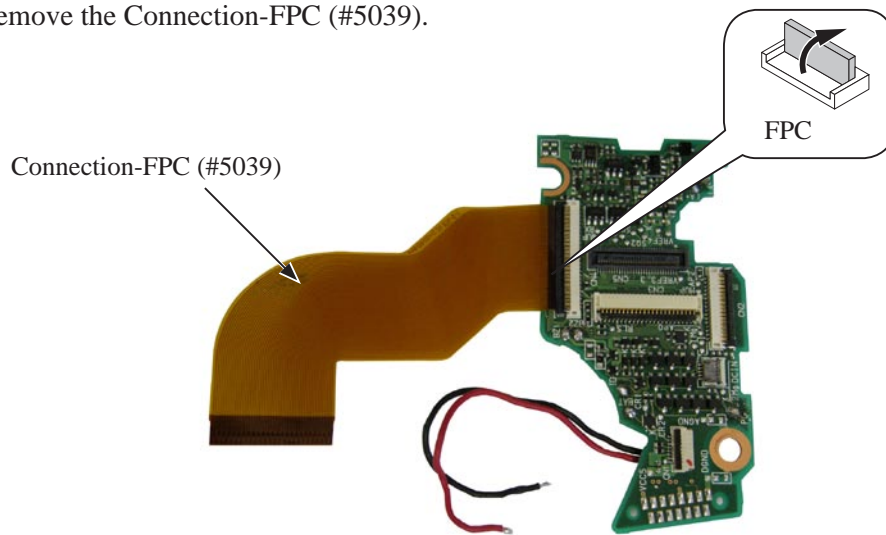

- Unsolder the wires ([Black][Red]).

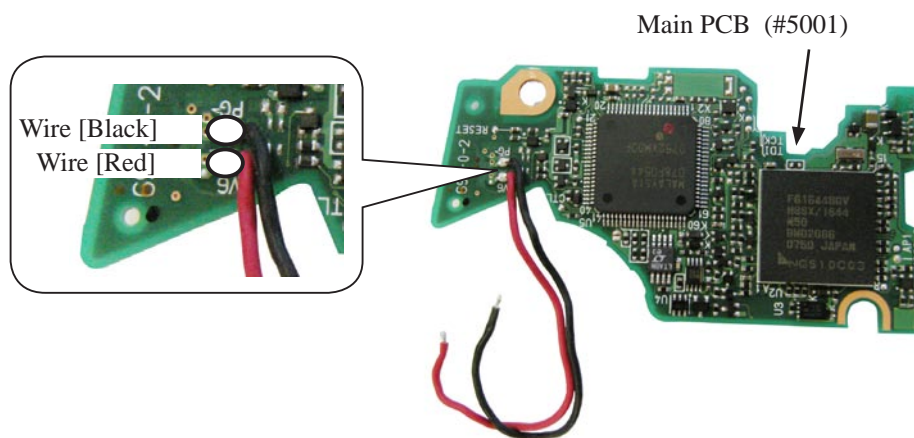

- Remove the Lug plate (#775).

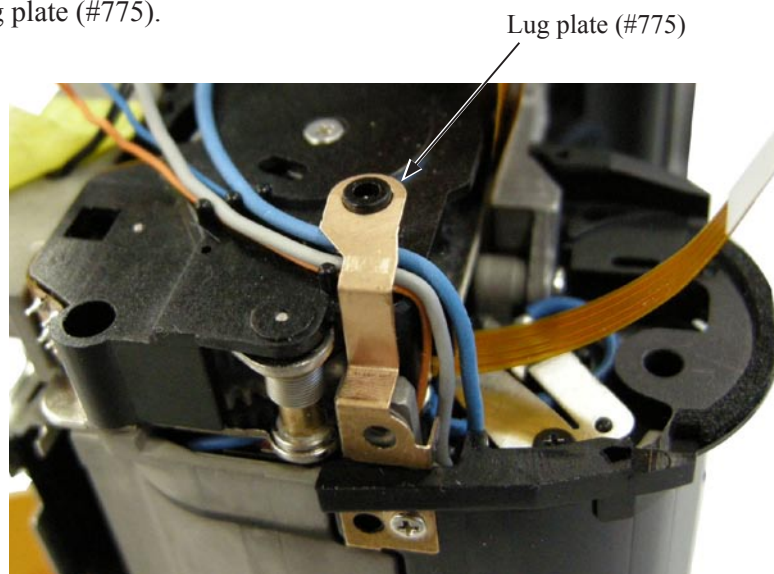

AF-assist lamp

- Take out the screw (#1638).
- Remove the AF-assist lamp unit (#B326).

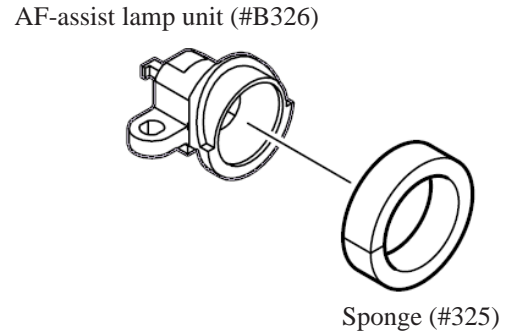
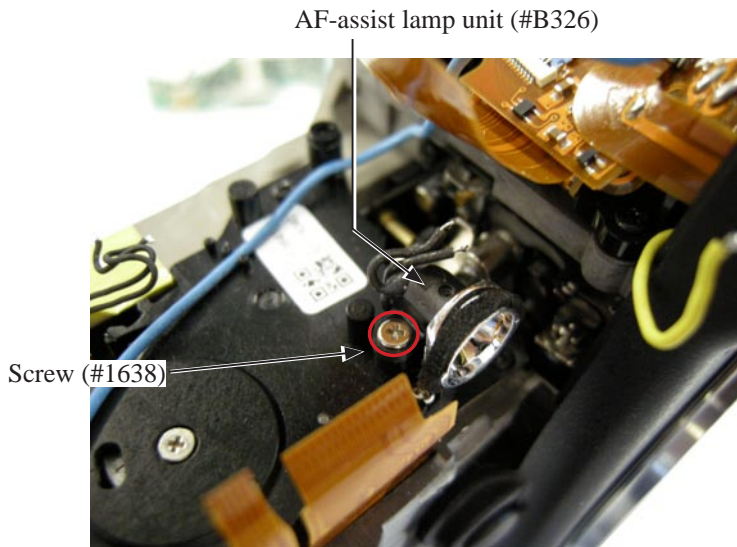

Grip-support mold

- Take out the screw (#1644).

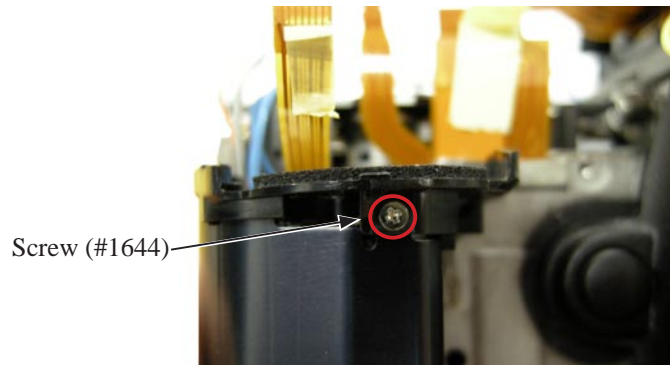

- Remove the grip-support mold (#58).
- Remove the sponge (#952) from the grip-support mold (#58).



Grip-support mold (#58)

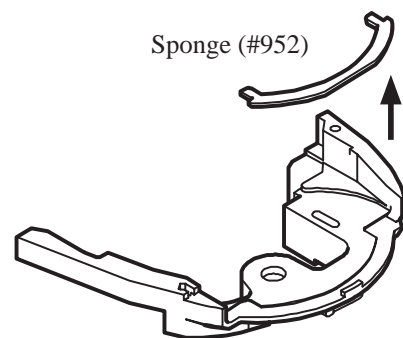

Grip-support mold (#58)

Separation of Front body from Rear body

- Peel off the TAPE #TA-0005 (10 × 20).
- Unsolder at four places, and pull out the FPC-end of the shutter unit (#B12001) through the hole of the penta FPC unit (#B5005).

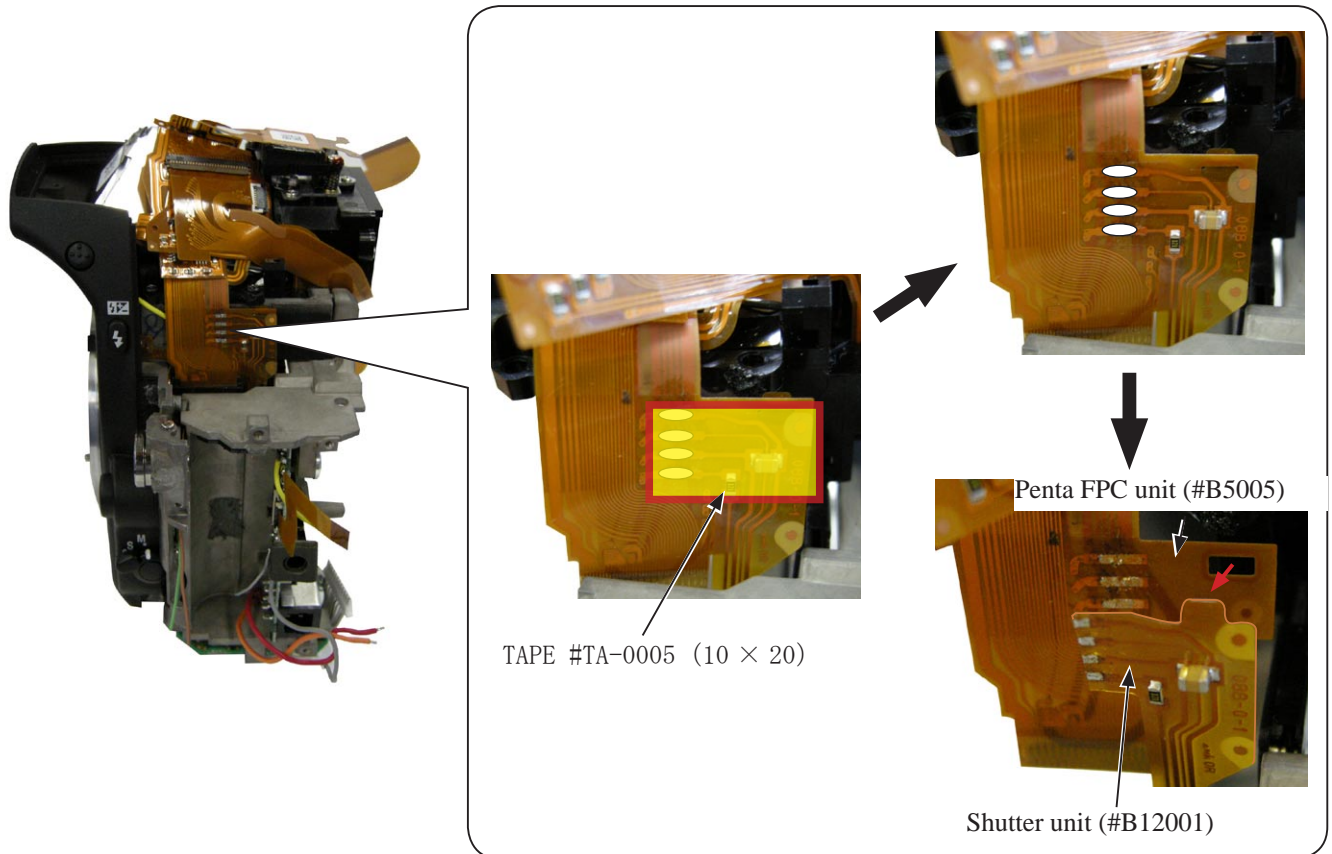

- Take out the screw (#1525).

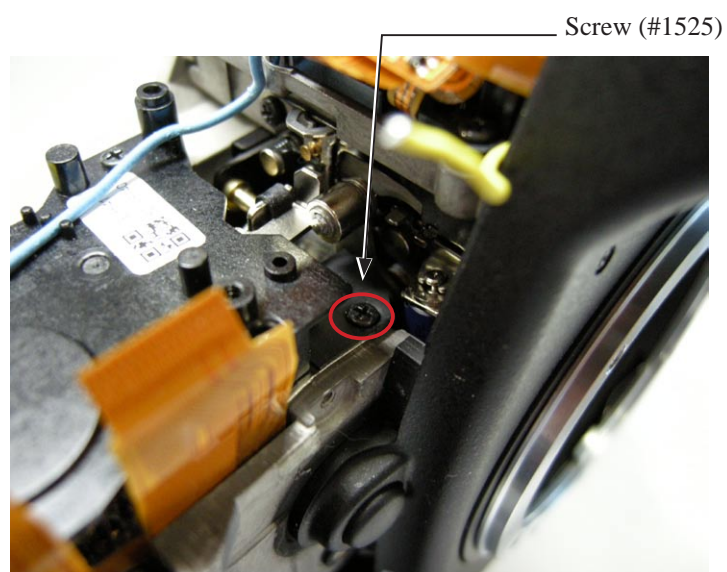

- Take out the five screws (#1575).

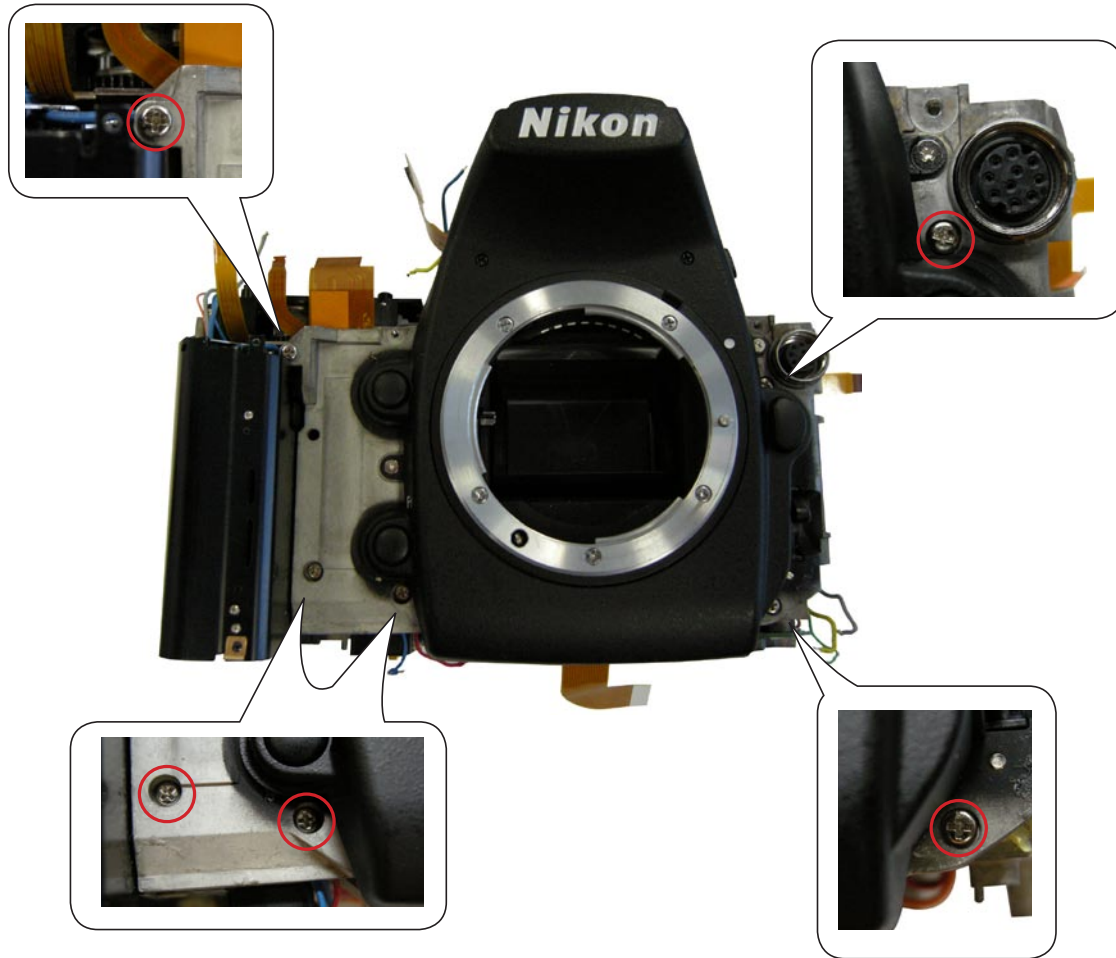

- Take out the four screws (#1531).

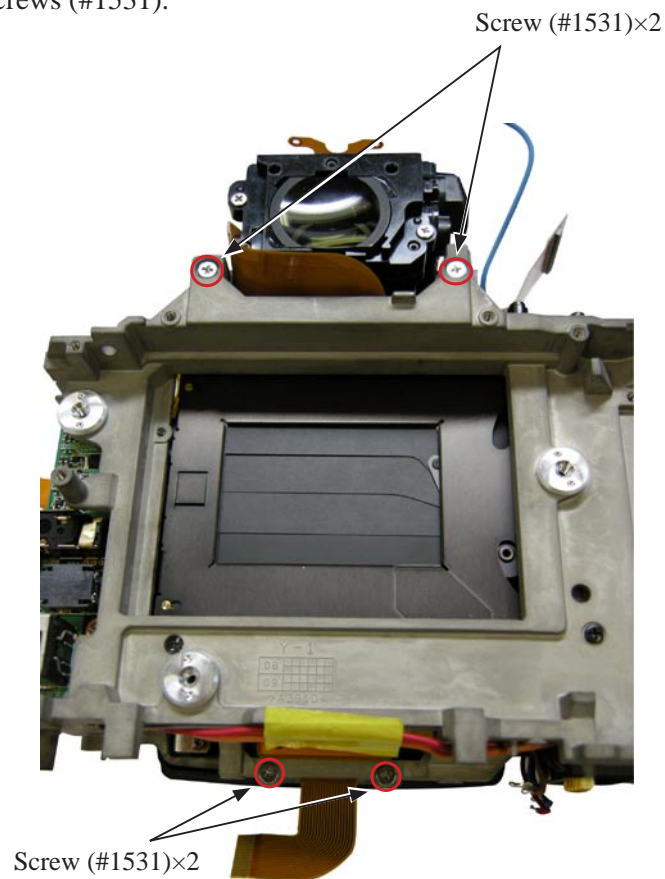

- Remove the front body unit (#B26RP) from the rear body.

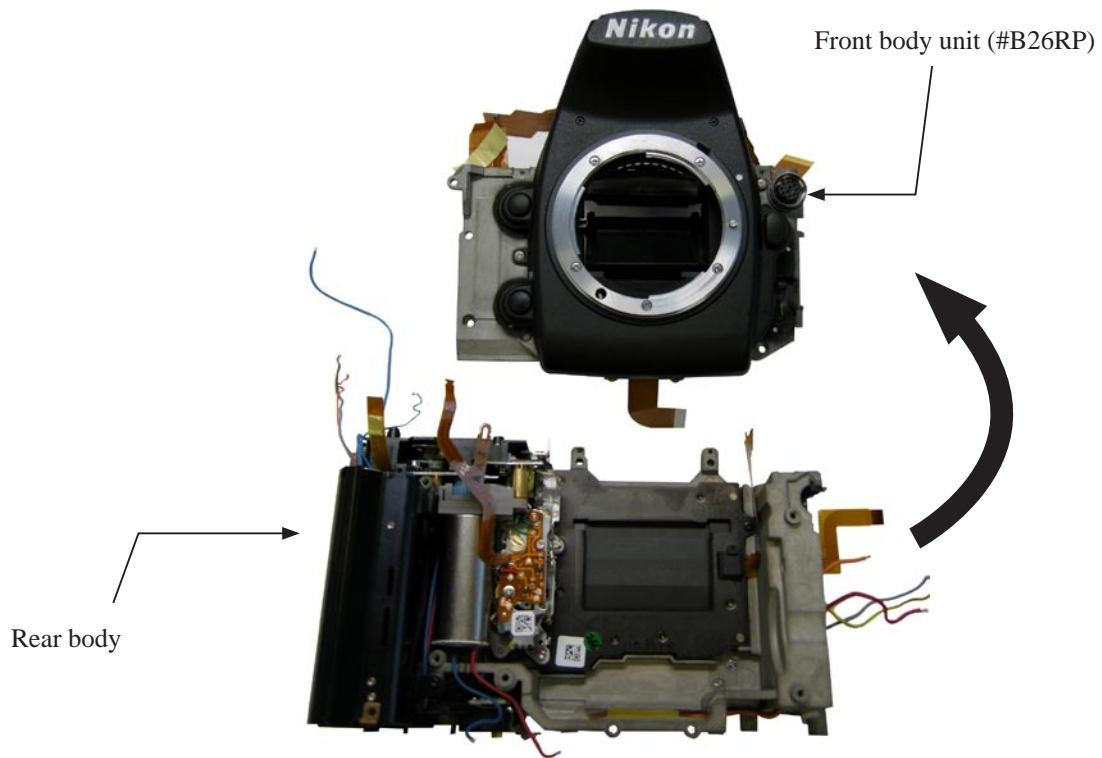

4. Separation of Prism box unit from Front body unit

Separation of Prism box unit from Front body unit

- Disconnect the FPC from the connector.

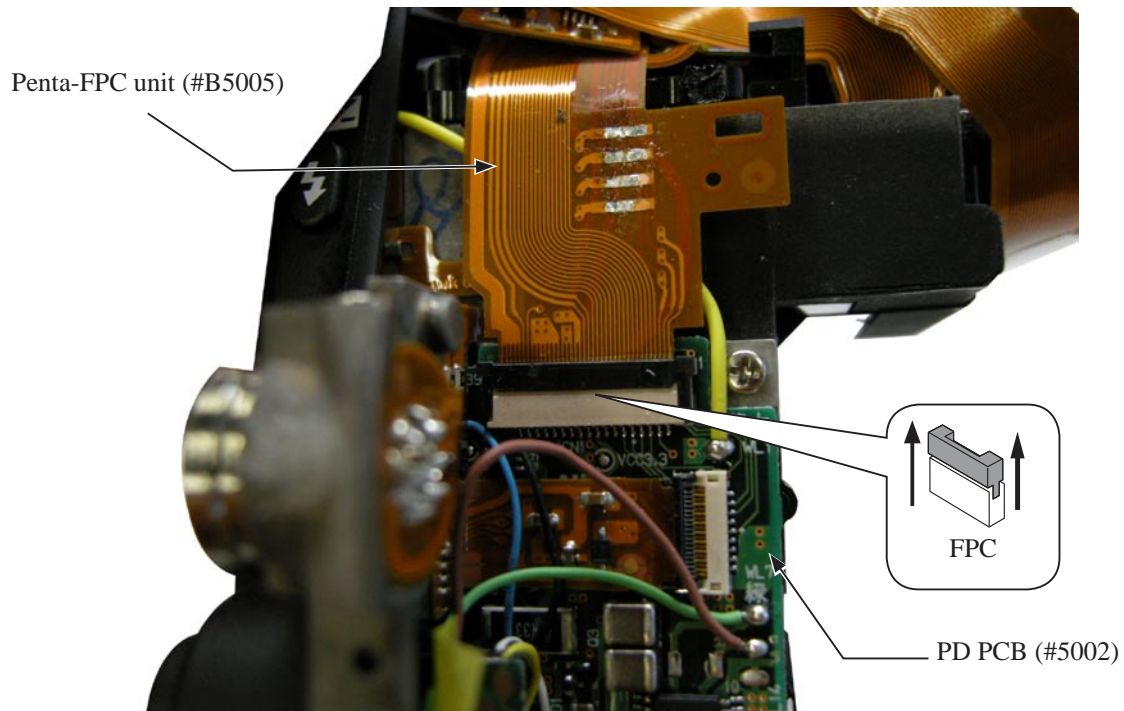

- Disconnect the FPC from the connector.

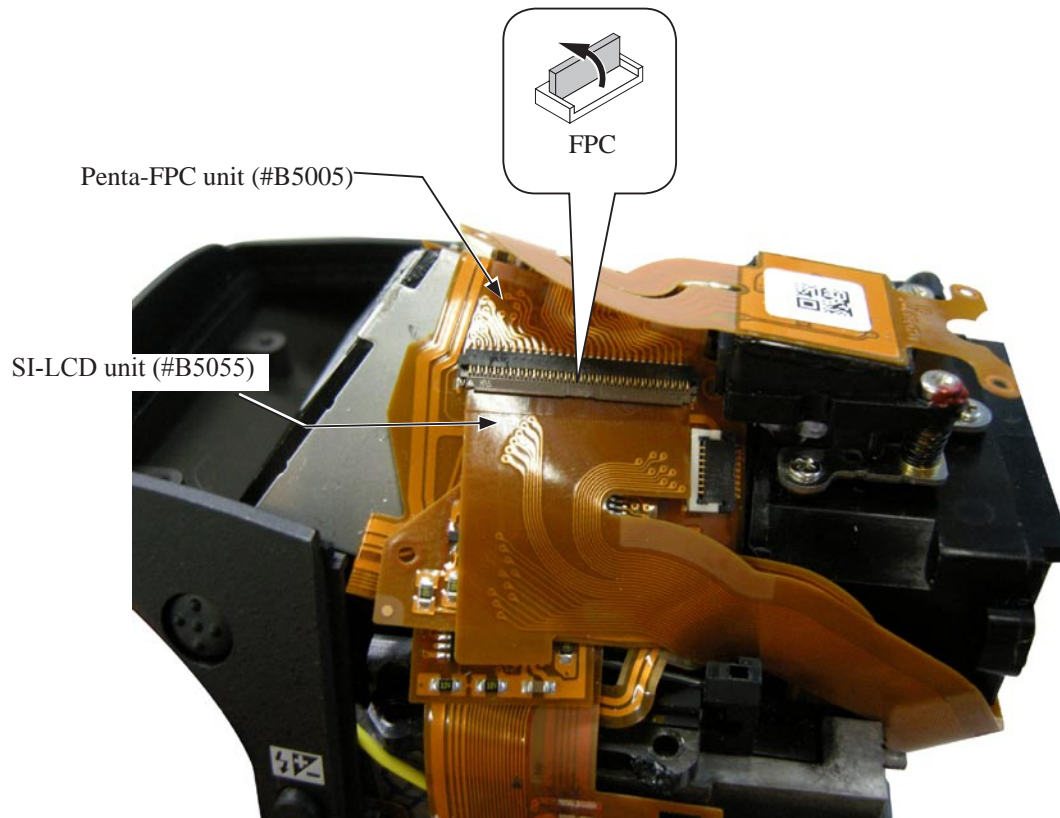

- Disconnect the FPC from the connector, (using caution with the direction of the connector).

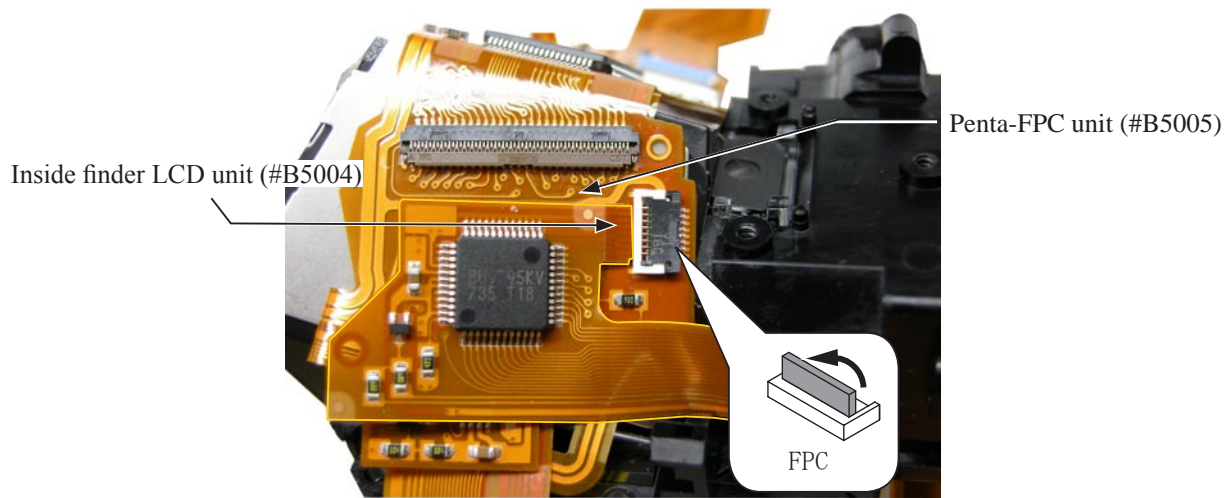

- Disconnect the FPC from the connector.

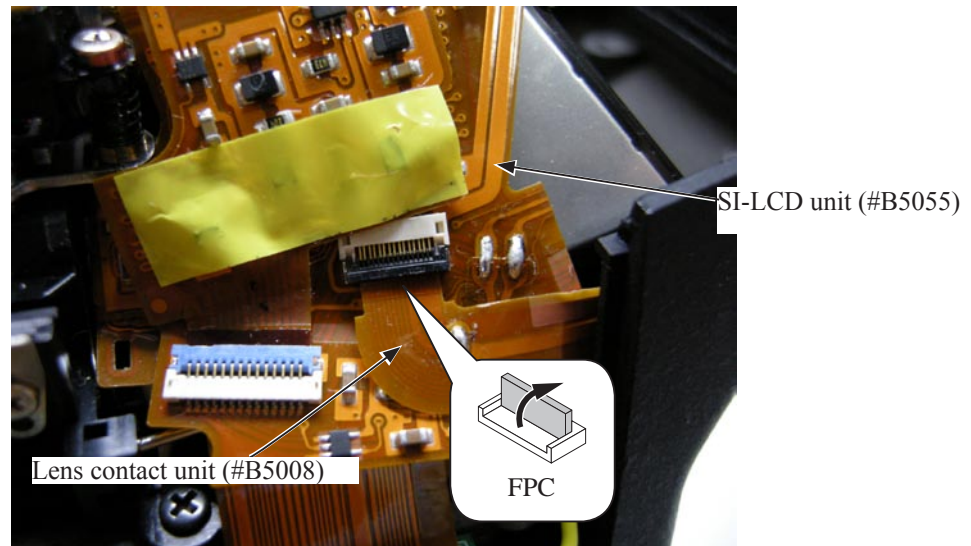

- Disconnect the FPC from the connector.

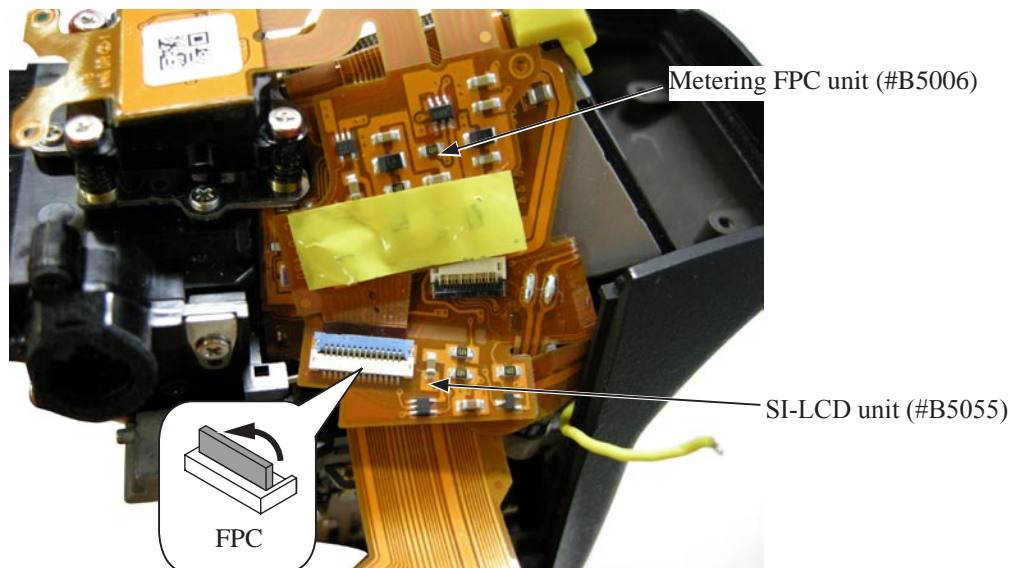

- Take out the four screws (#1525).

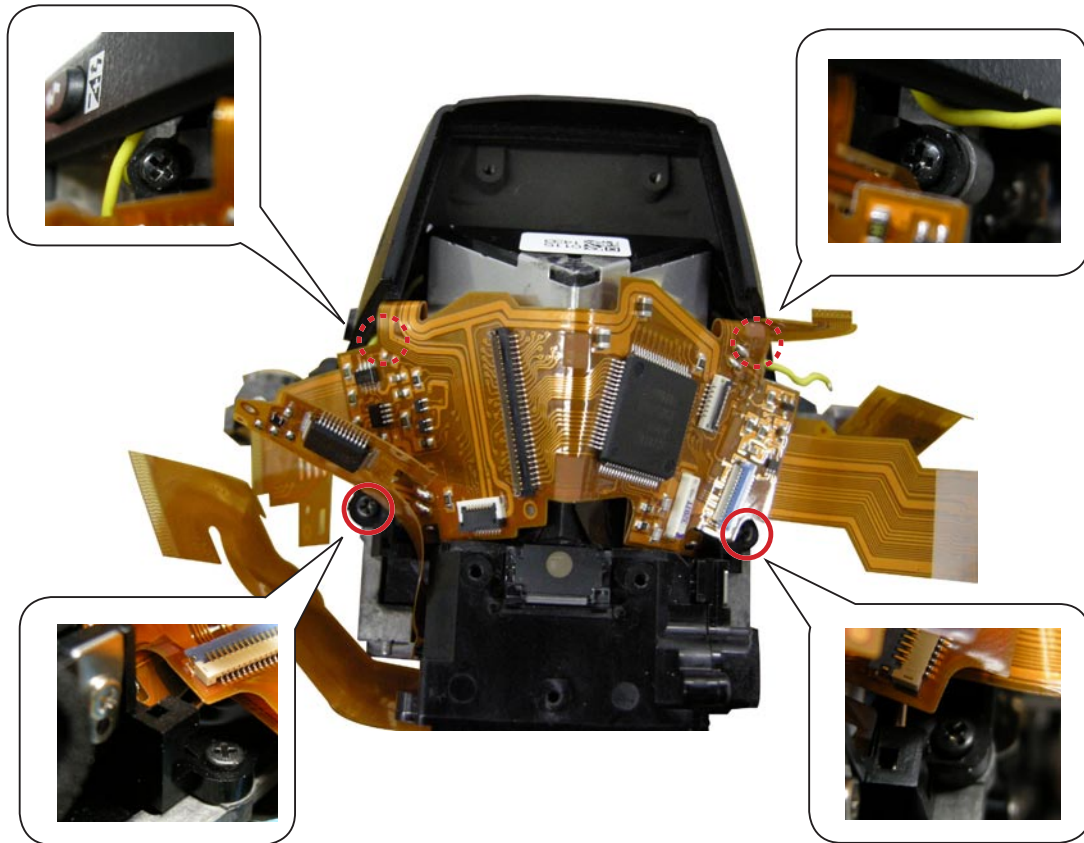

- Remove the prism box unit (#B1101RP).

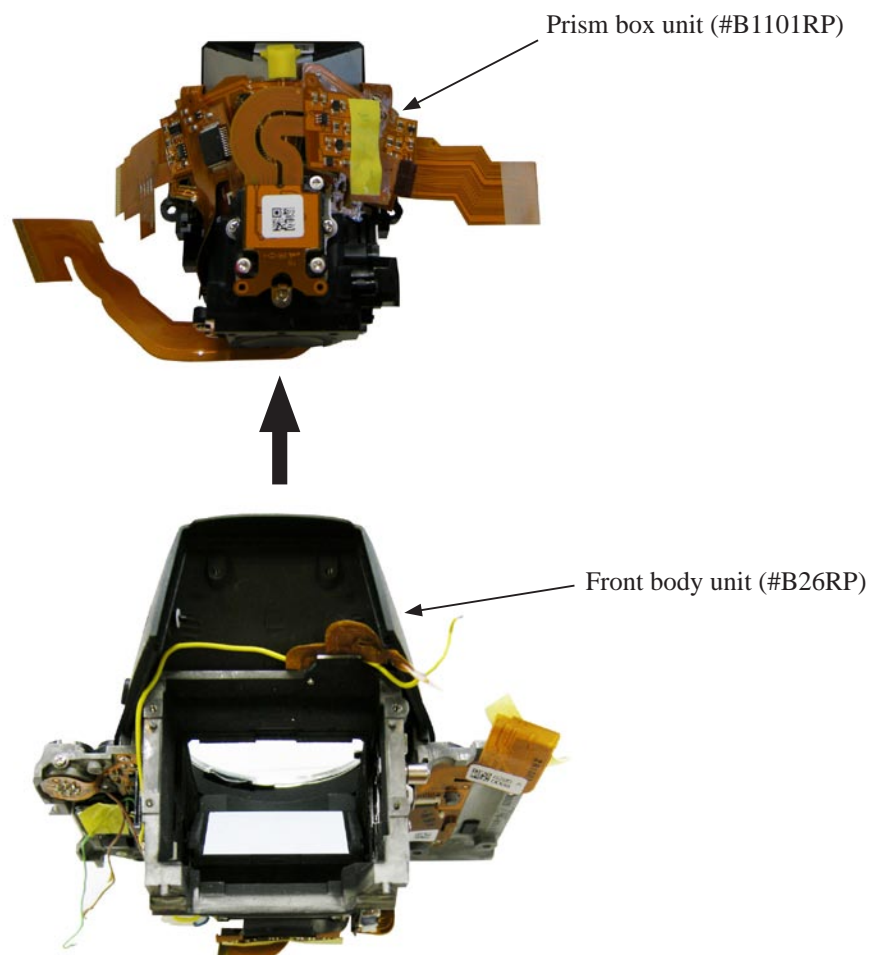

5. Prism box unit

Metering FPC unit

- Take out the three screws (#1541).

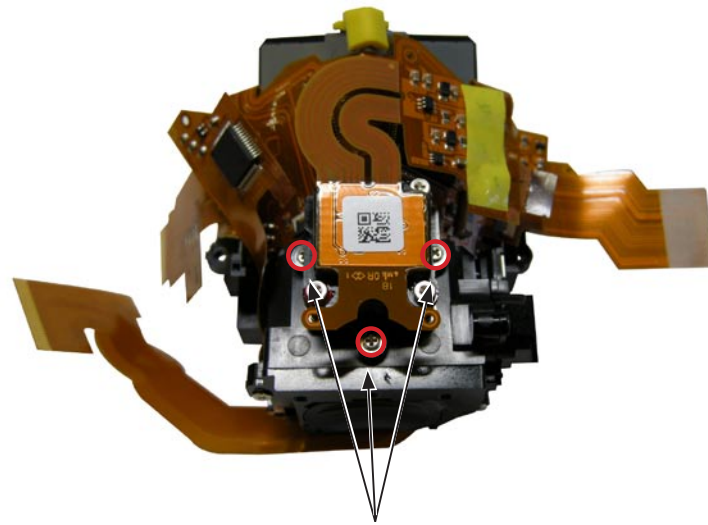

Screw (#1541)×3

- Remove the metering FPC unit (#B5006).

Metering FPC unit (#B5006)

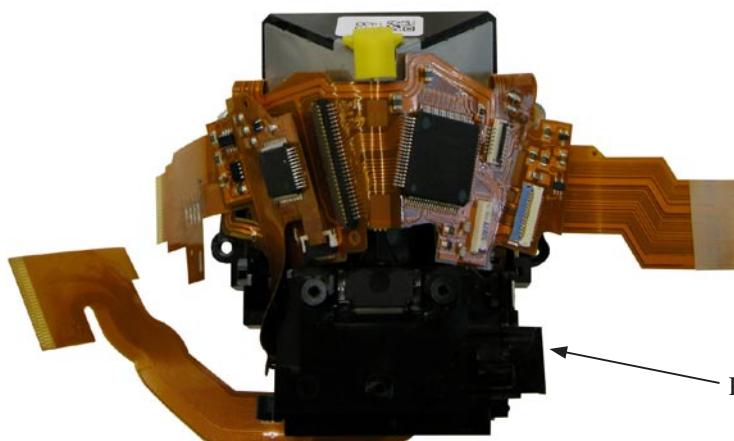
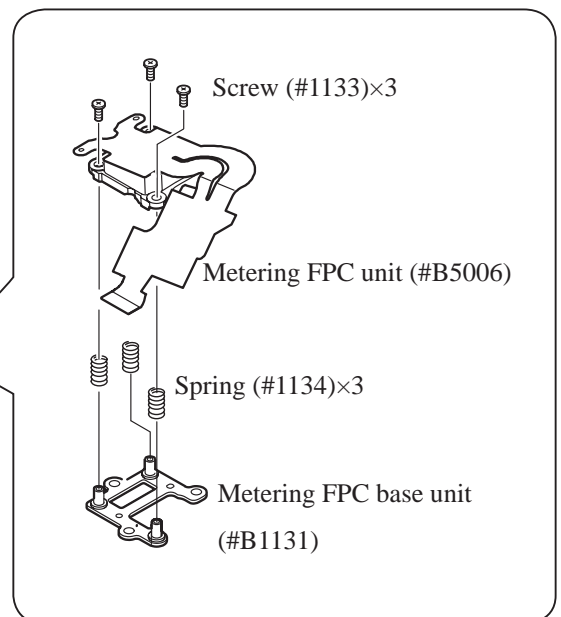
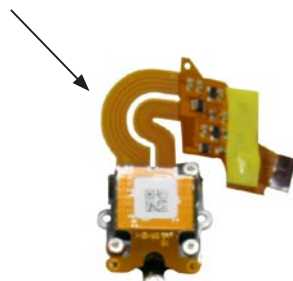

Prism box unit (#B1101RP)

Screen

- Remove the four solders of the penta FPC unit (#B5005).

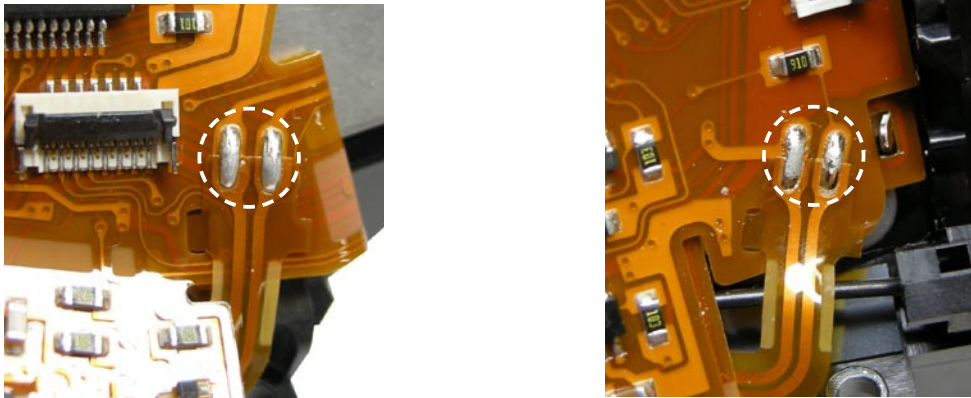

- Remove the penta FPC unit (#B5005) from the prism box unit (#B1101RP).

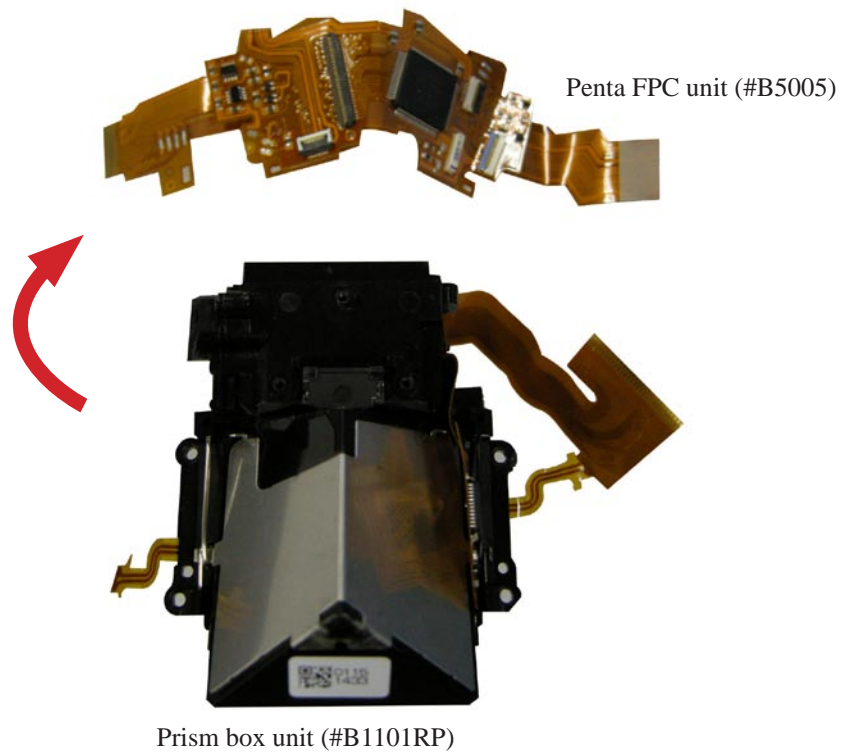

- Remove the Spring (#1103) from the prism box unit (#B1101RP).

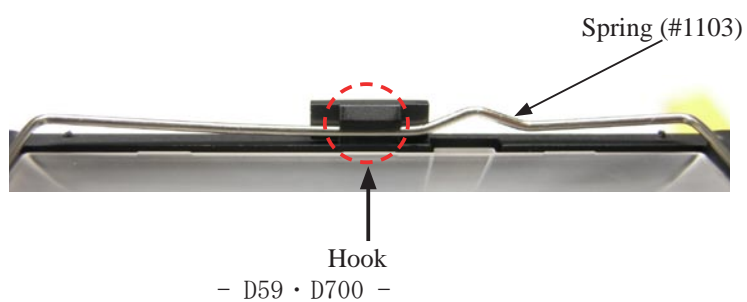

- Remove the screen (#3).
- Remove the Washer (#1180A-C).

#1180A-D △ (Revision)

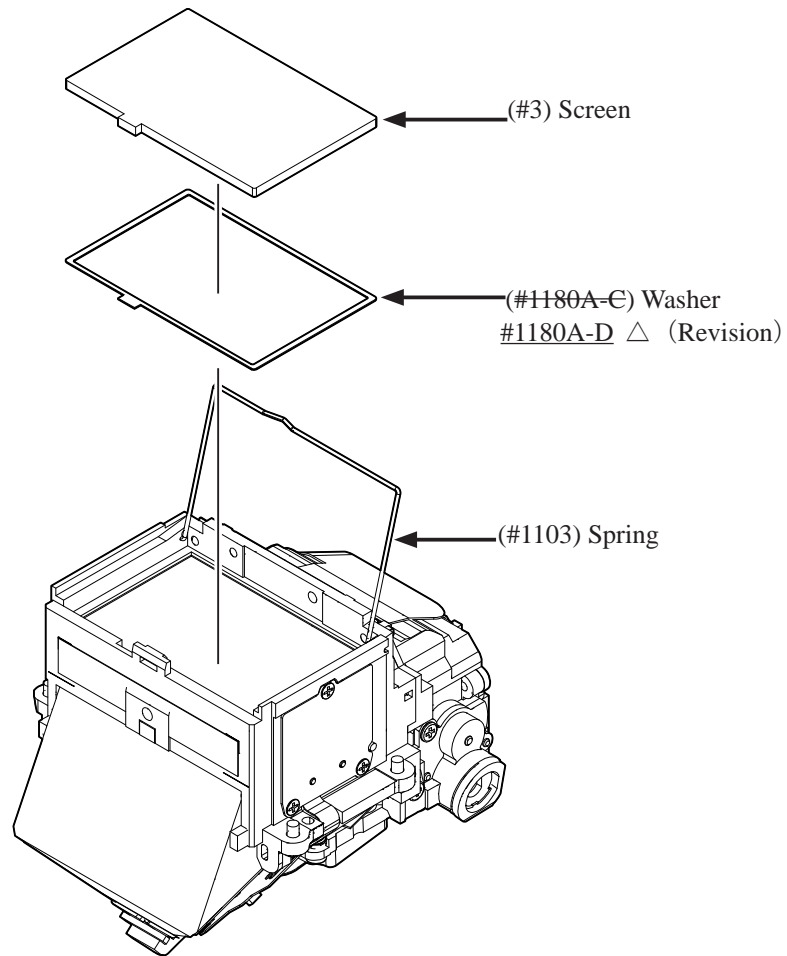

- Unhook the Spring (#1103) at both ends from the holes of the prism box unit (#B1101RP).

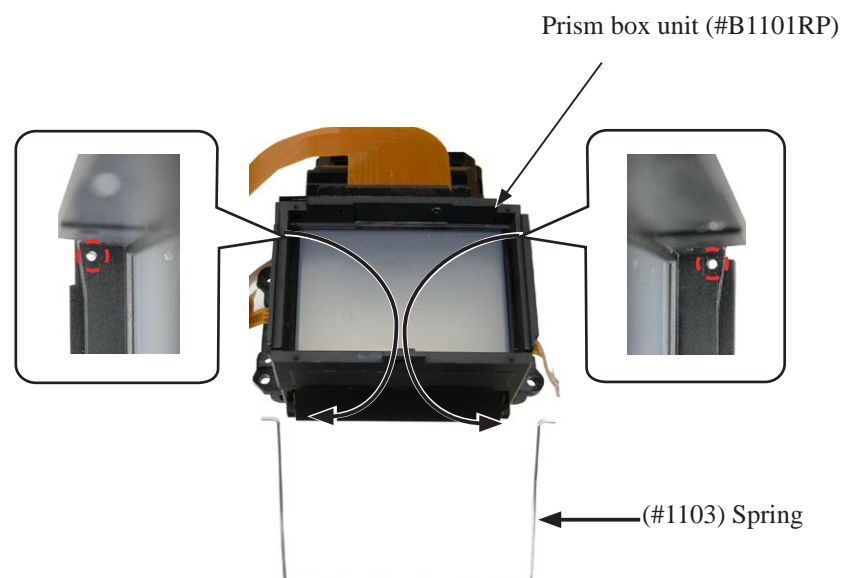

Penta prism

- Peel off the Tape (#1203).

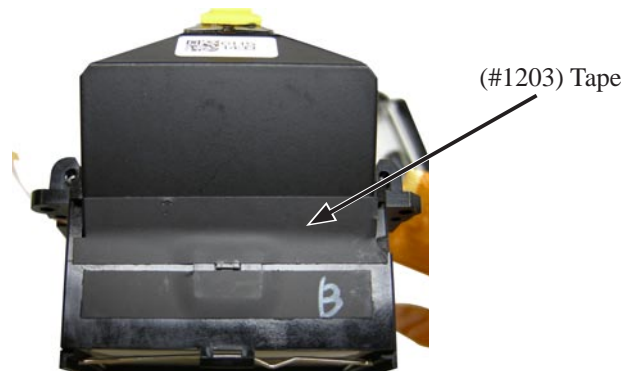

- Remove the Springs [(Grip-side; white)(#1215) and (I/F-side; black)(#1112)] by releasing each hook in the numeric order.

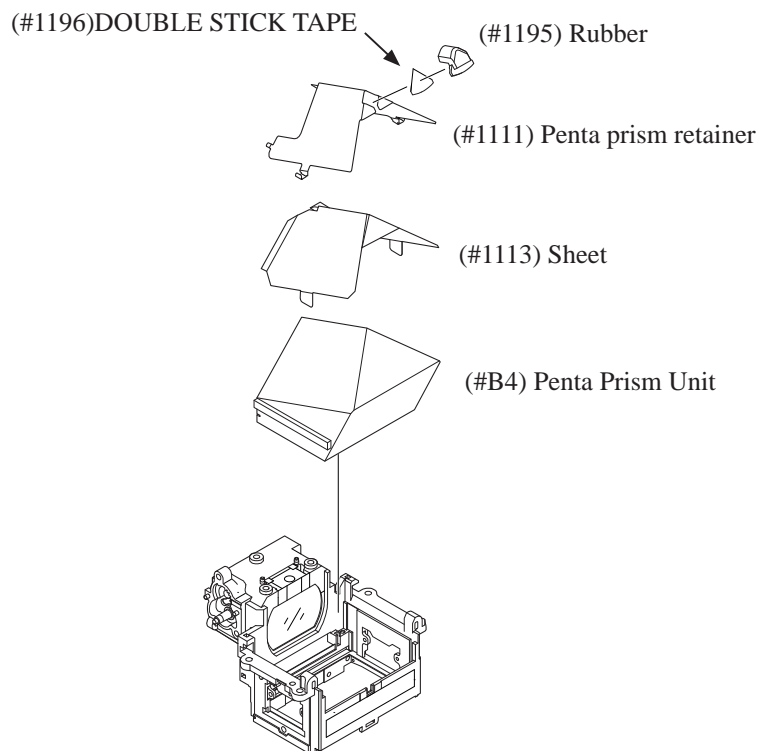
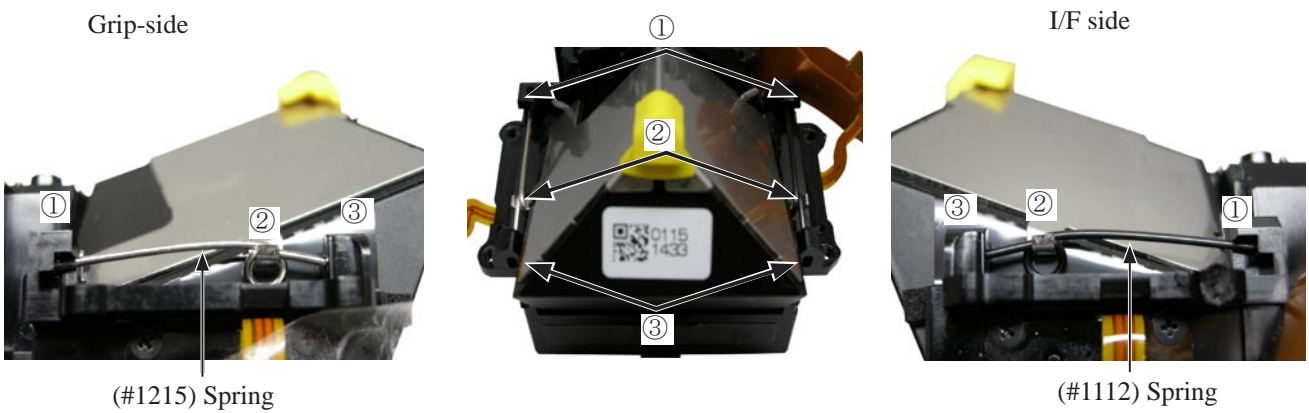

Diopter adjustment mold

- Remove the finder frame (#1108).

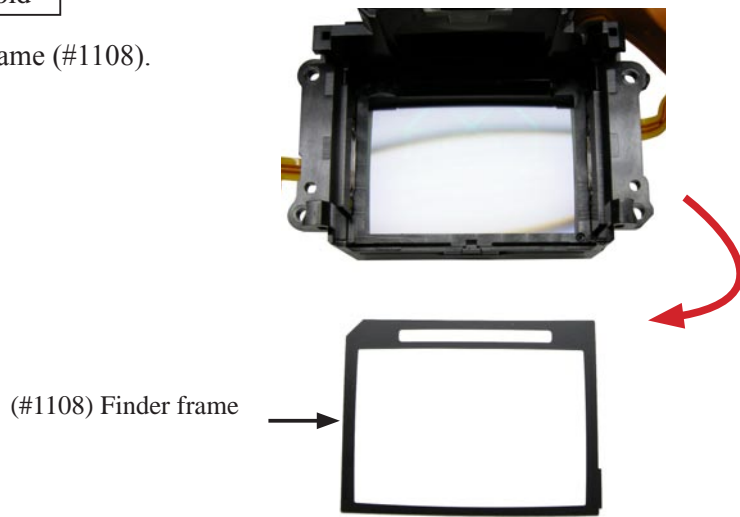

- Take out the screw (#1595), and remove the plate (#1126).

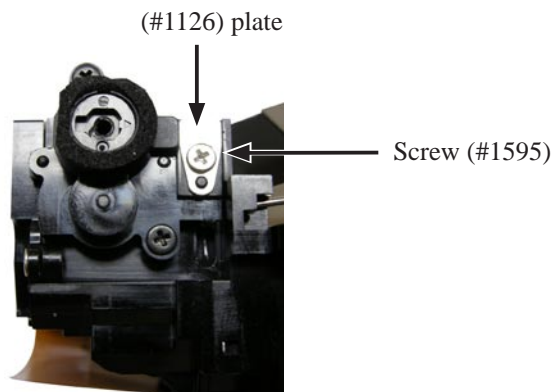

- Remove the Spring (#1127) first, then steel ball (#1136), (using caution to avoid popping out of the spring).

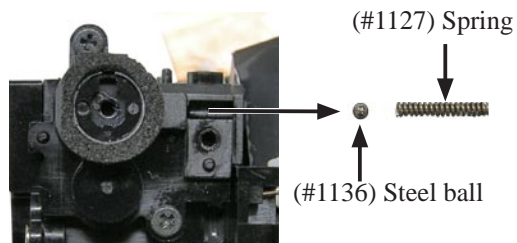

- Take out the two screws (#1595), and remove the Mold (#1123).

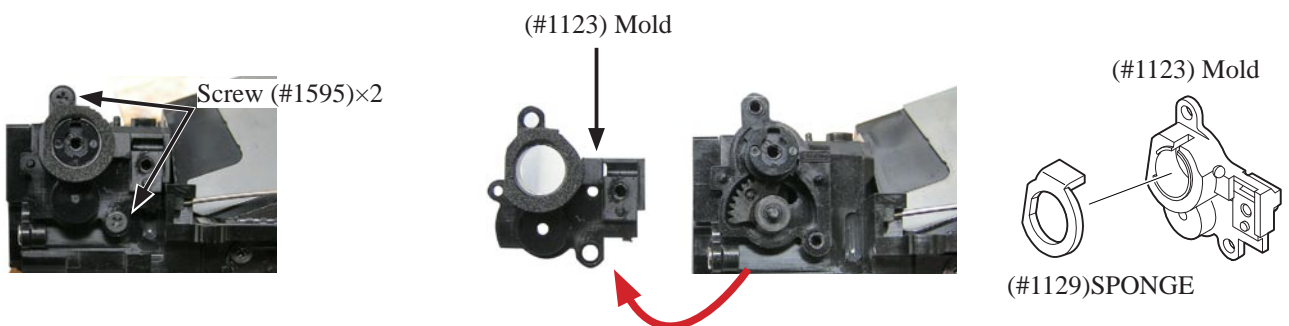

- Remove the gear (#1125) and cam (#1128).

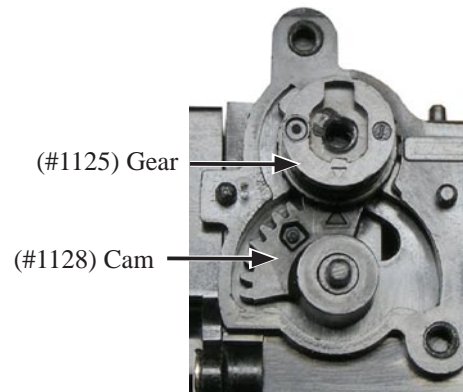

Diopter adjustment unit

- Take out the two screws (#1597).
- Remove the Plate (#1120) (by releasing from the two hooks).

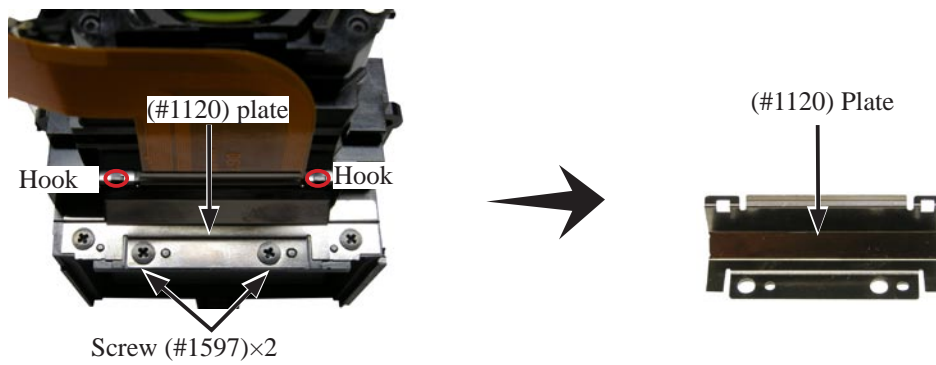

- Take out the two screws (#1595).
- Remove the Eyepiece Lens Unit (#B1119).

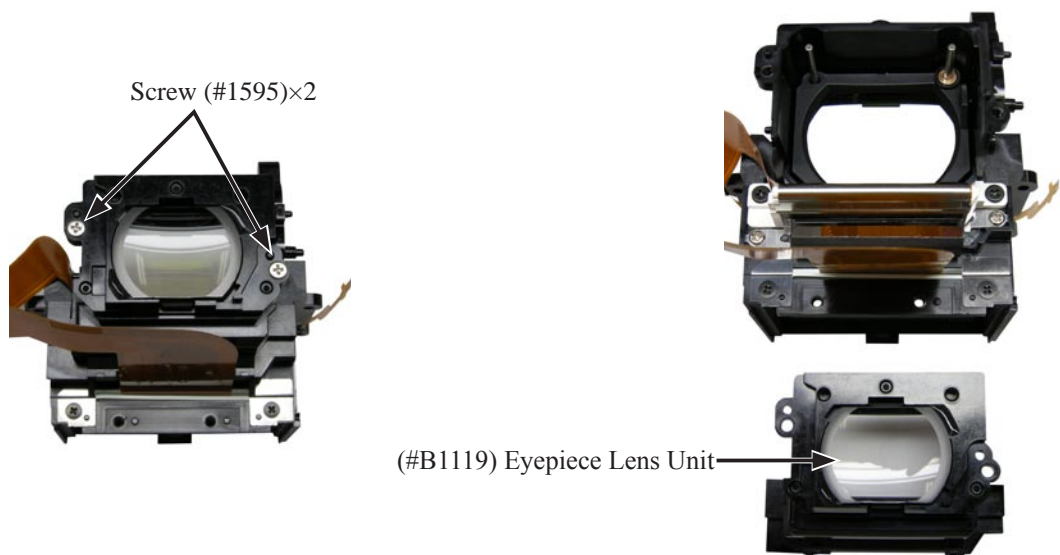

- Remove the Diopter Lens Unit (#B1118).
- Pull out the two Diopter Shafts (#1122).

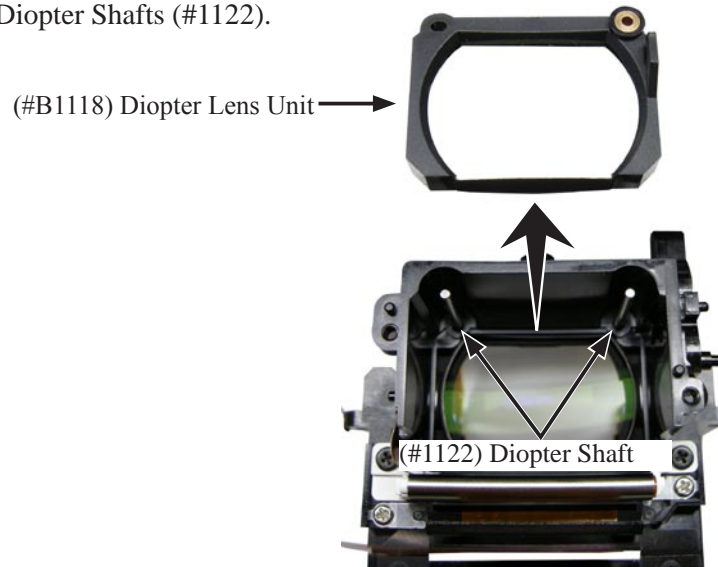

Inside finder LCD unit

- Remove the inside finder LCD unit (#B5004) by separating the FPC from the boss.

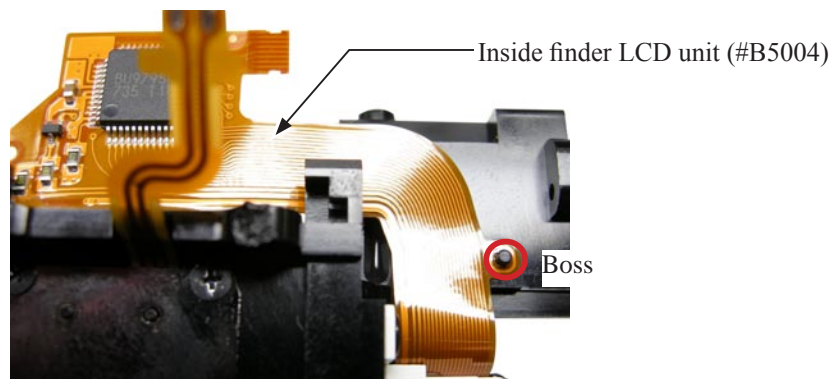

- Take out the two screws (#1585).

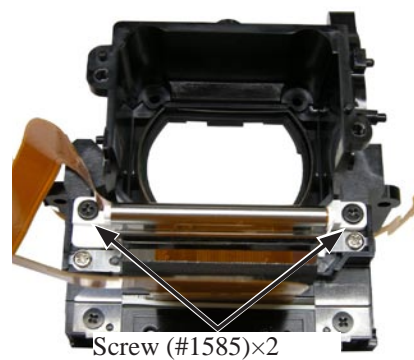

- Remove the inside finder LCD unit (#B5004),
(being careful not to damage the prism.)

(#B5004) Inside finder LCD unit

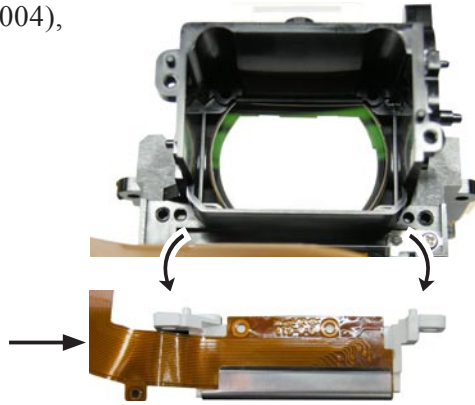

SI unit

- Take out the two screws (#1537).
- Remove the two plates (#1185), (using caution because the their edges are inserted into the square holes of the prism box unit.)

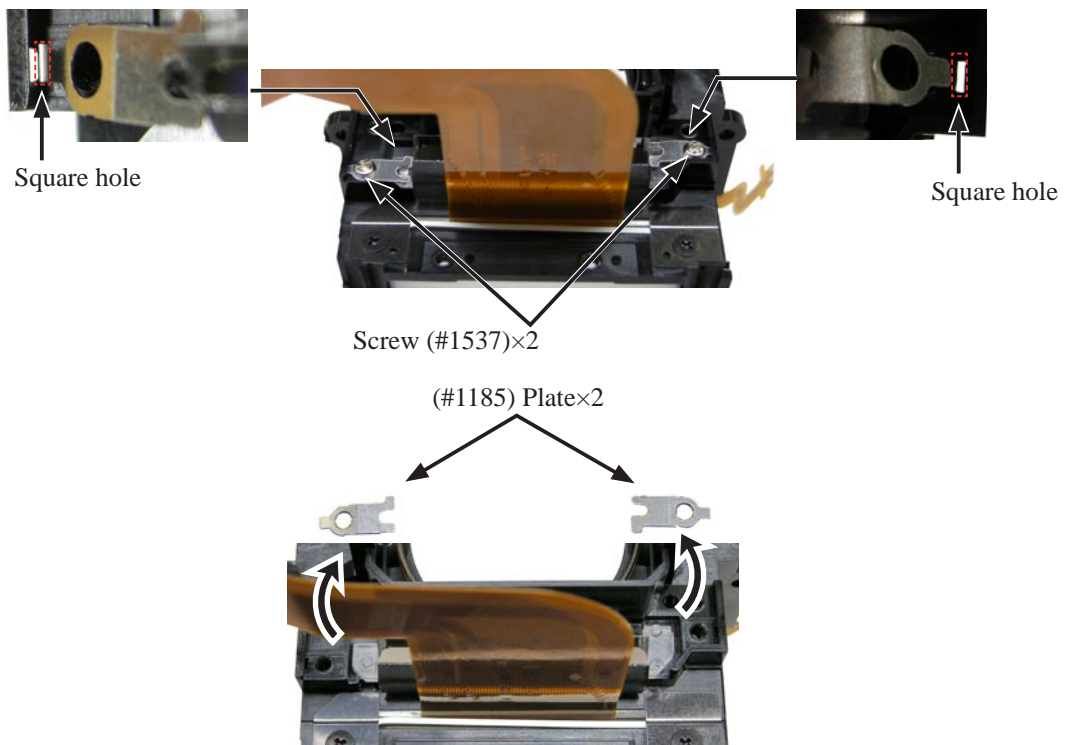

- Remove the lower display prism (#8).

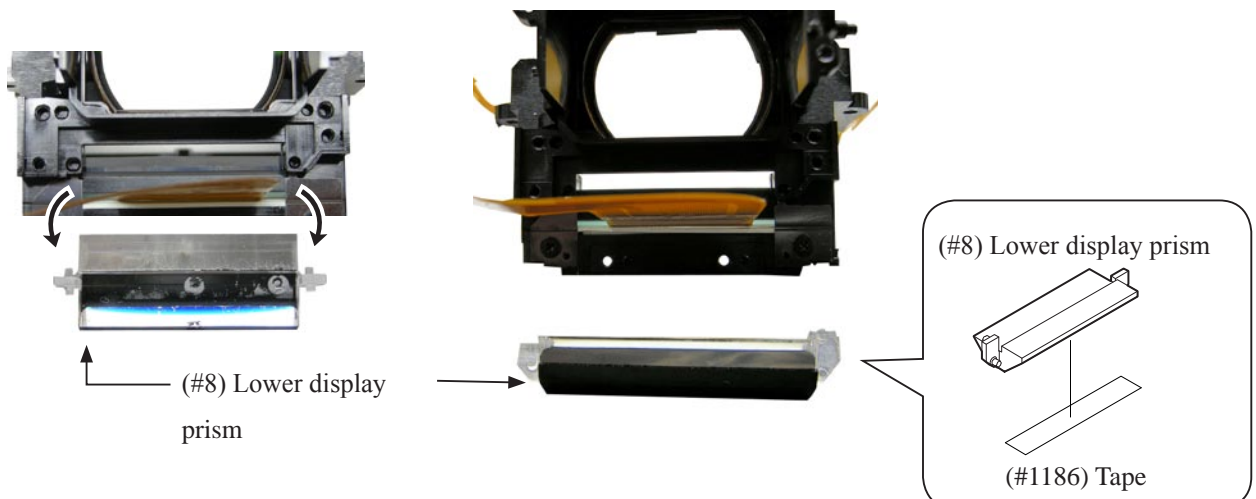

- Take out the three screws (#1597).
- Remove the plate (#1167).

Screw (#1597)×3

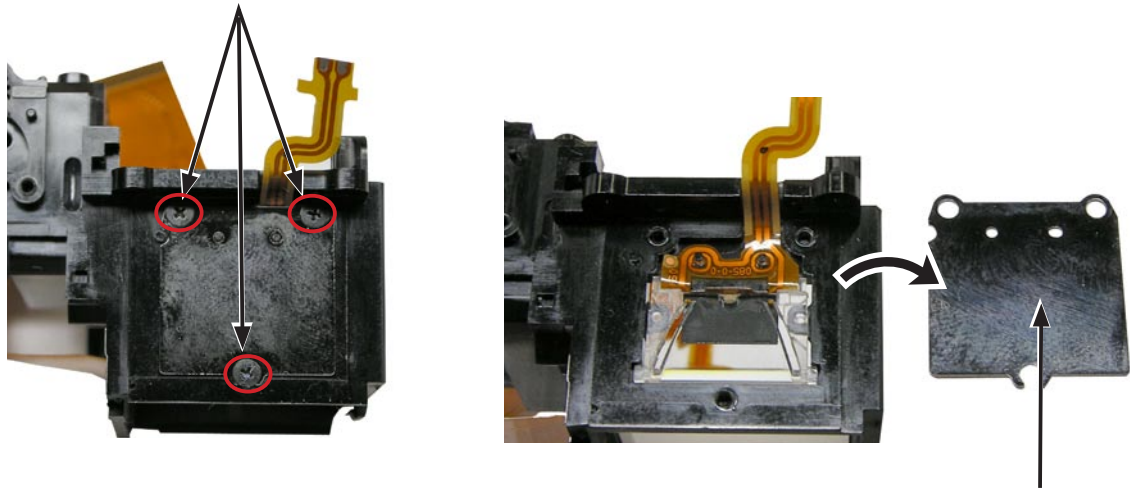

- Perform the same works on the rear side, too.

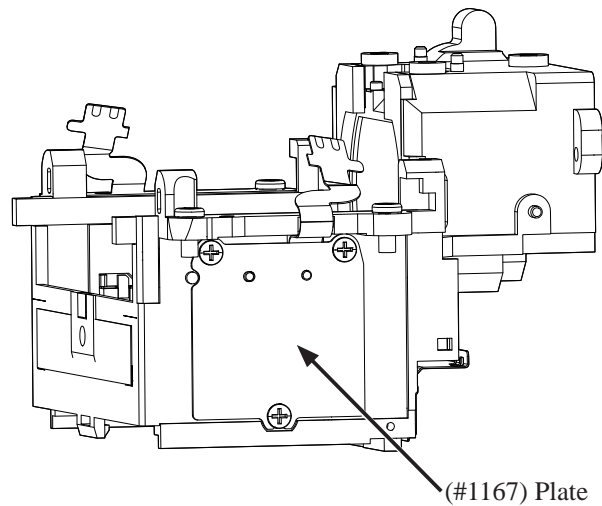

- Pull and remove the SI guide unit (#B1168), being careful NOT to damage the FPC.

(#5011) SI LCD FPC

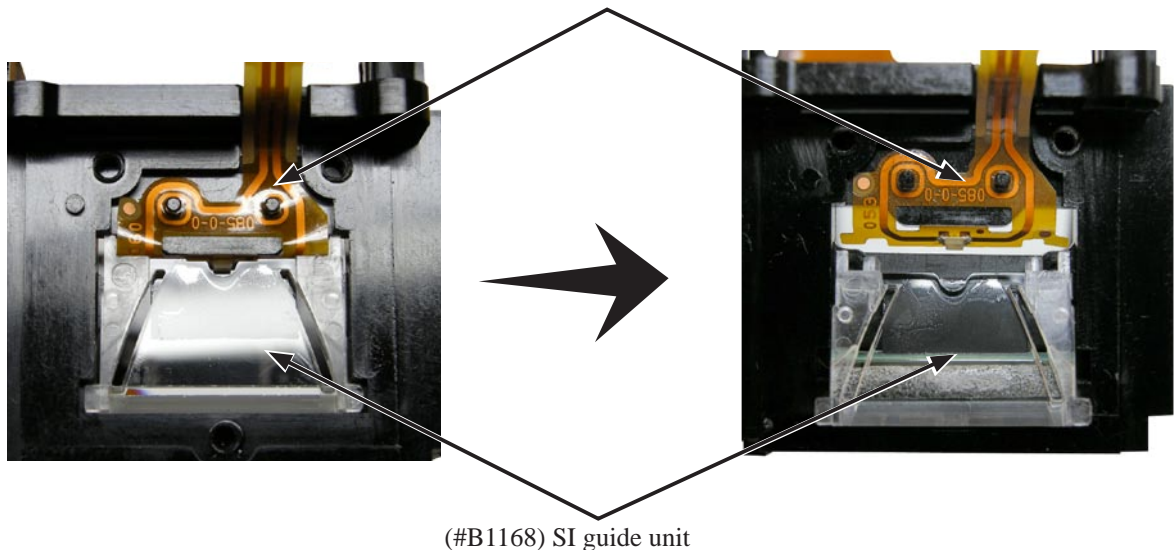

- Remove the Spacer Frame (#1109).
- Remove the condenser lens (#19), (being careful NOT to damage it).

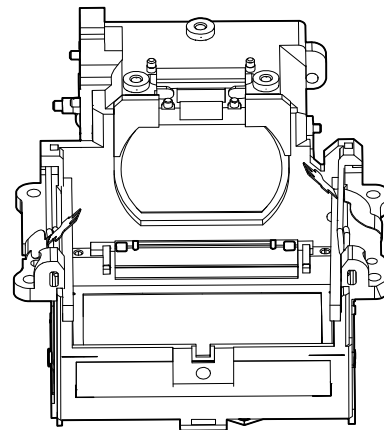
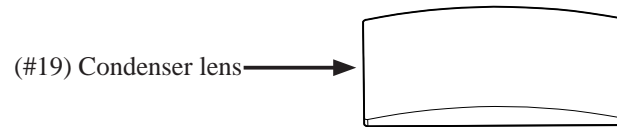
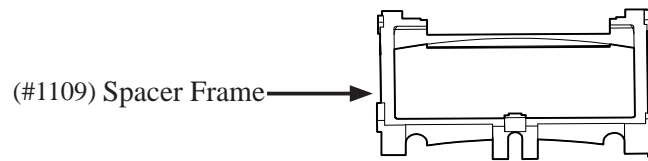

- Remove the finder frame (#1107).



(#1107) Finder frame

- Take out the two screws (#1597).
- Remove the Plates (#1163 and #1164)(using caution because the their edges are inserted into the square holes of the prism box unit.)

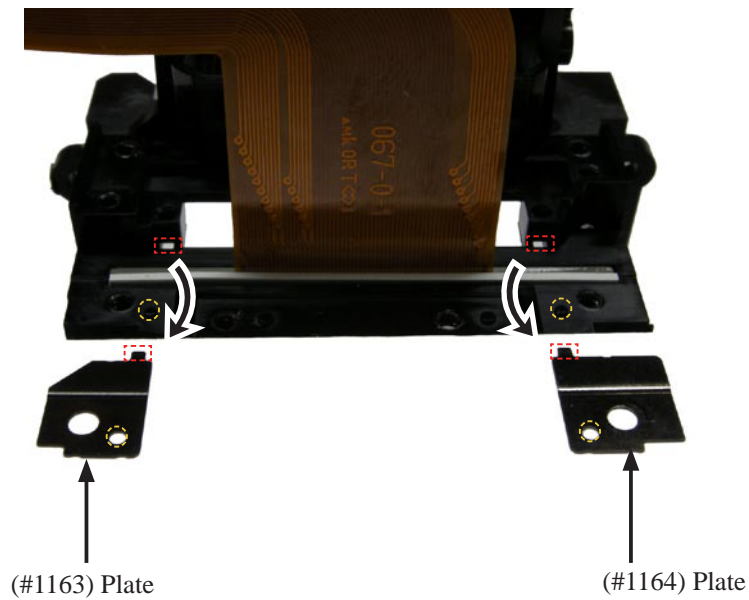
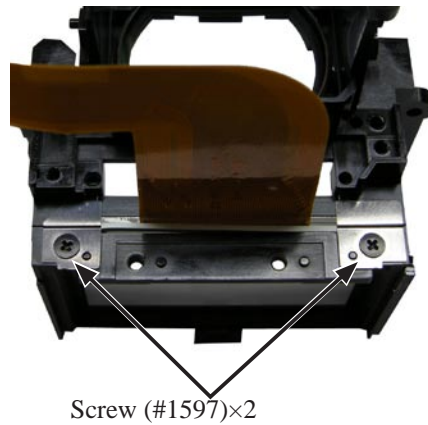

- Remove the rubber (#1117) from the lower part of the SI-LCD unit (#B5055).

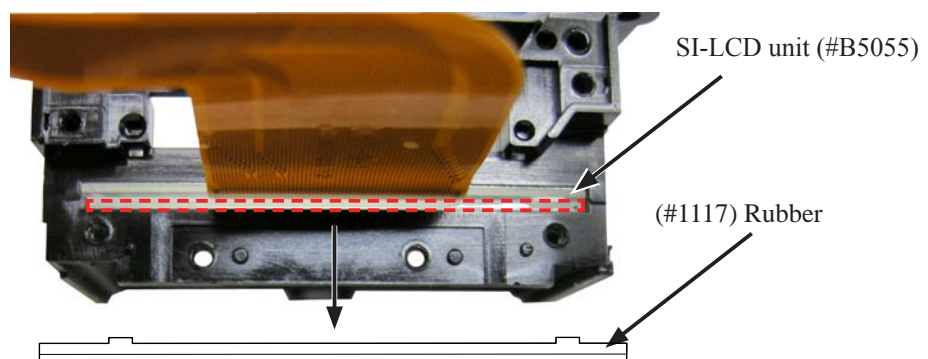

- Pull the SI-LCD unit (#B5055) from the prism box unit (#B1101RP).

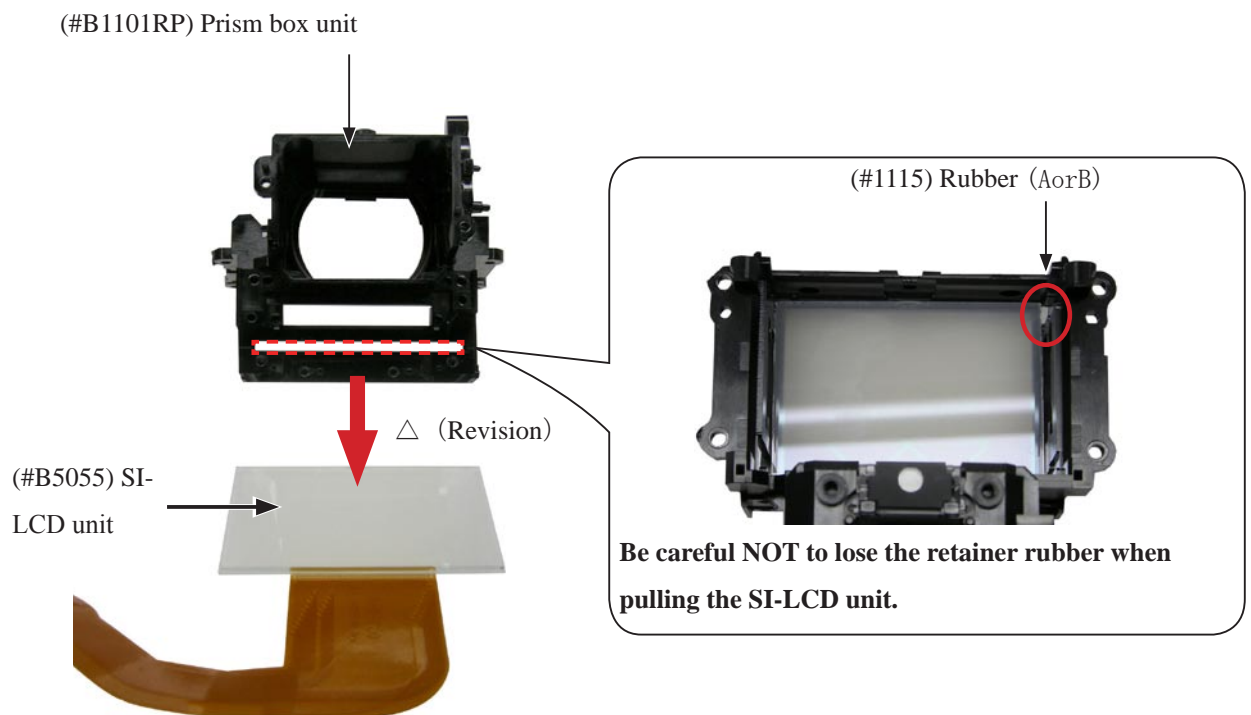

6. Front body unit

Power drive

- Pull out the wire [Yellow] of the PD PCB (#5002).

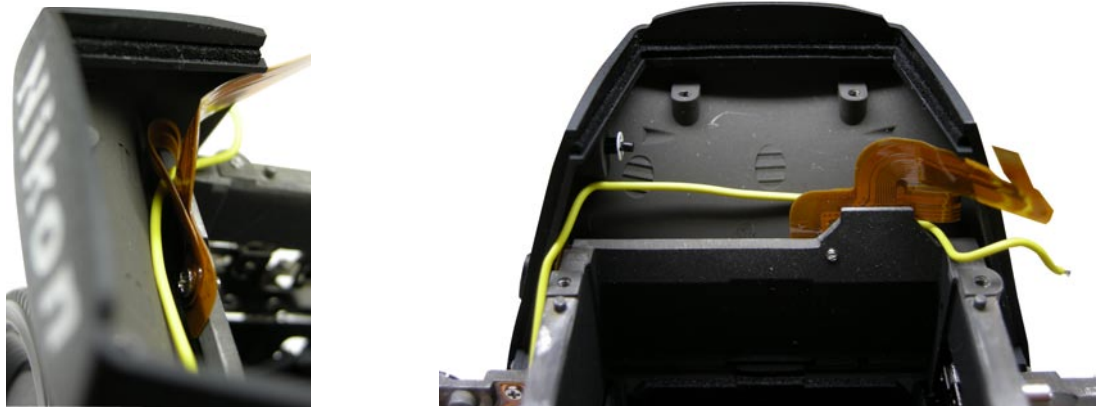

- Peel off the tape [#TA-0005 (10×20)].

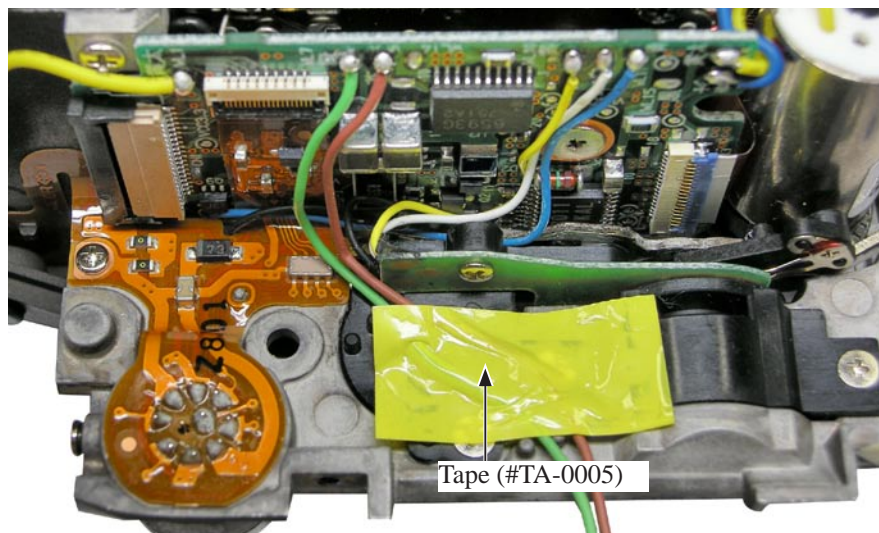

- Disconnect the FPC from the connector.

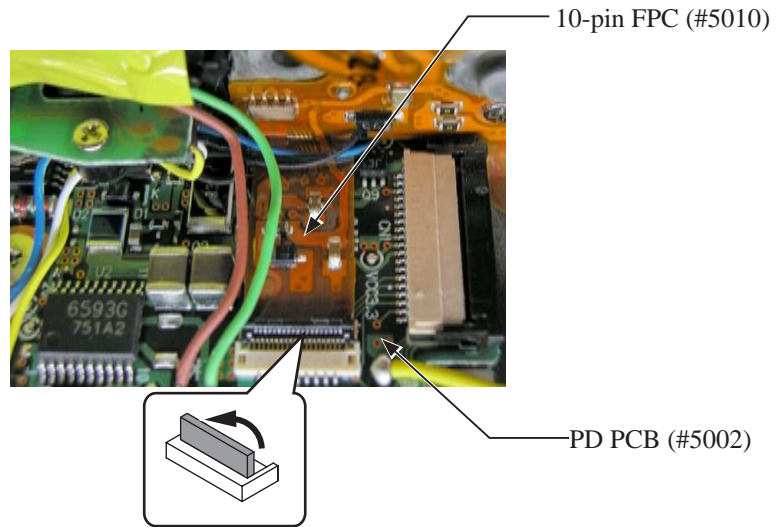

- Disconnect the FPC from the connector.
- Unsolder the wires ([Blue][White][Yellow]) from the PD PCB (#5002).
- Unsolder the wires of AF motor ([Blue][Yellow]).
- Take out the two screws (#1663).
- Remove the PD PCB (#5002).

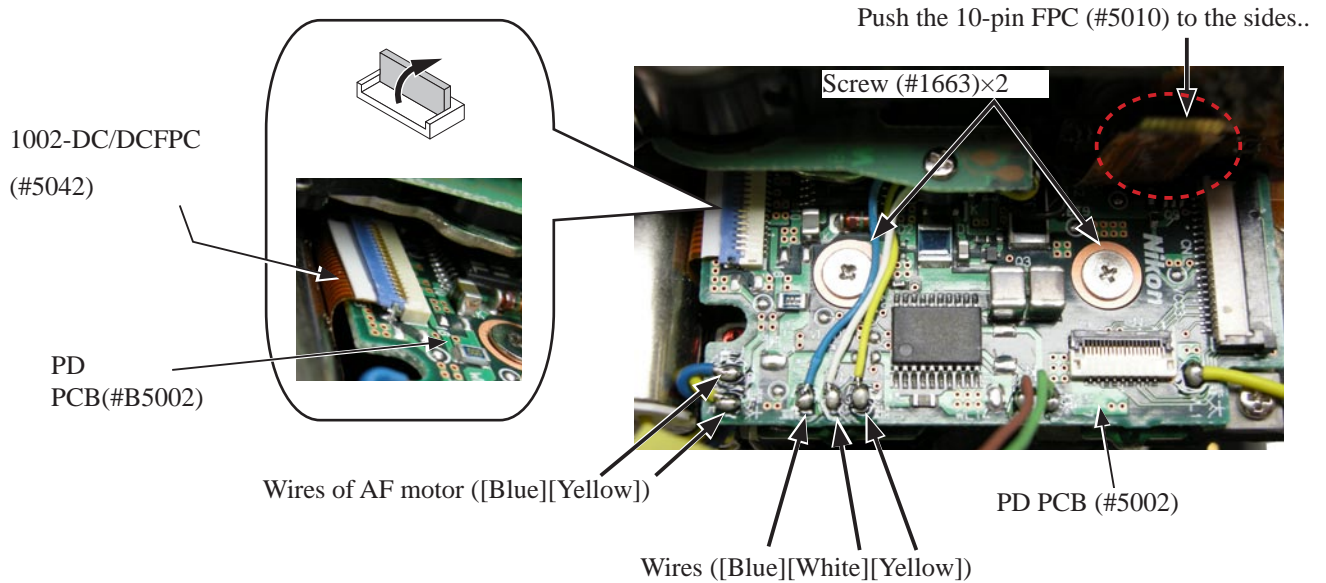

AF sensor

- Remove the connection-FPC (#5042).

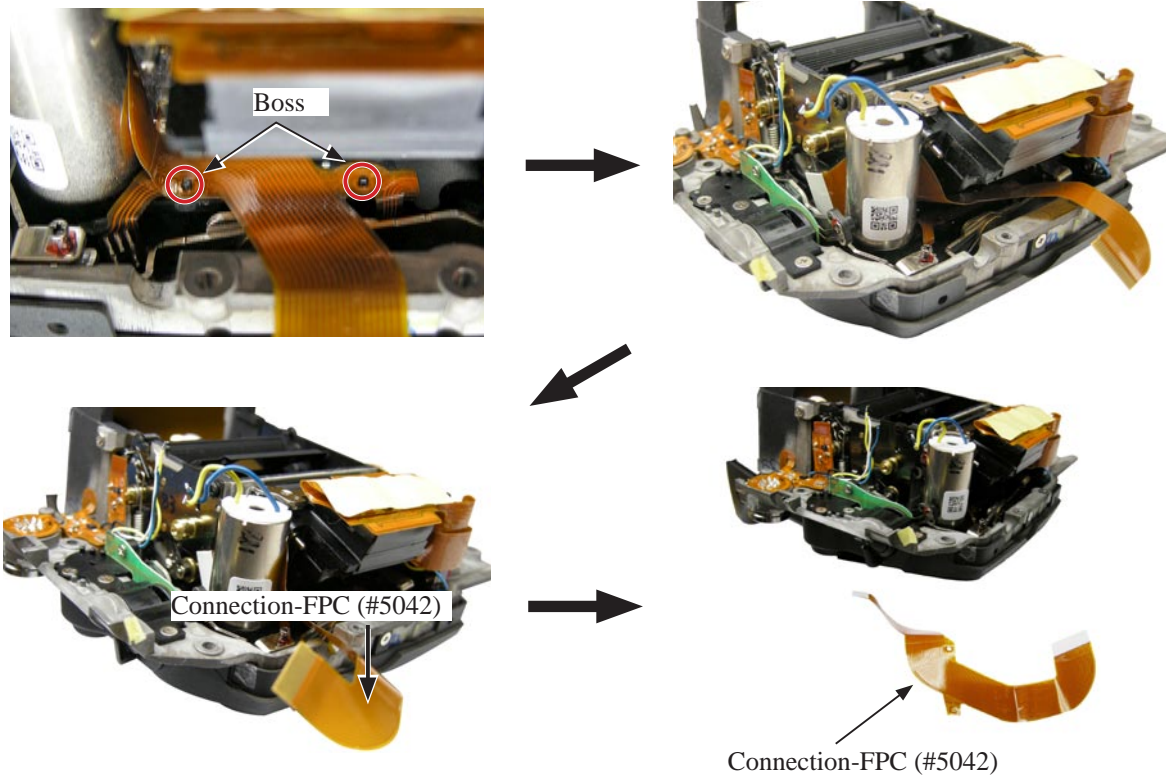

- Disconnect the FPC from the connector.
- Take out the screw (#1503).

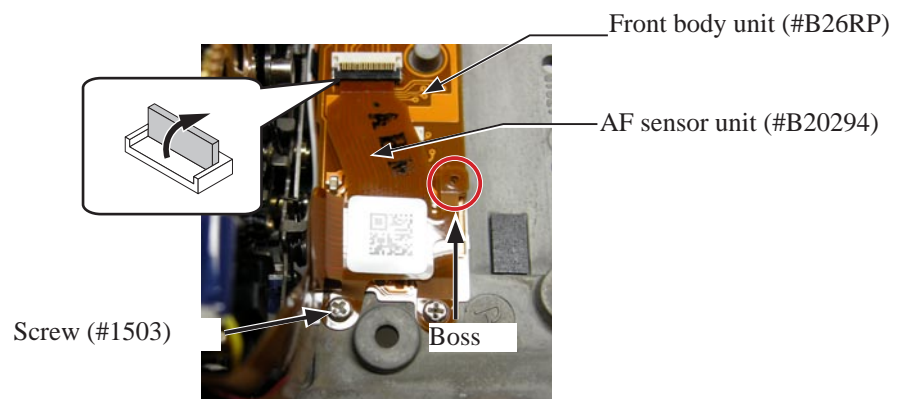

- Remove the E ring (#1653) from the support pole.
- Remove the washer (#274), (with caution to avoid popping out or losing it.)

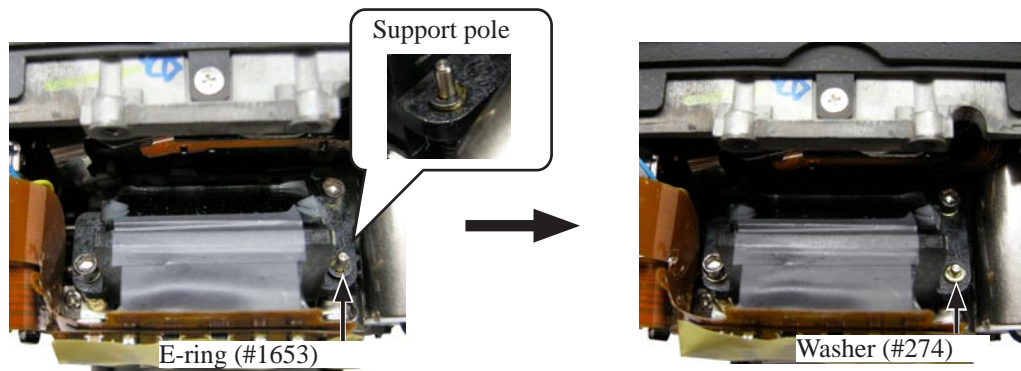

- Take out the two screws (#275) and remove the two washers (#1657).
- Remove the AF sensor unit (#B20294).

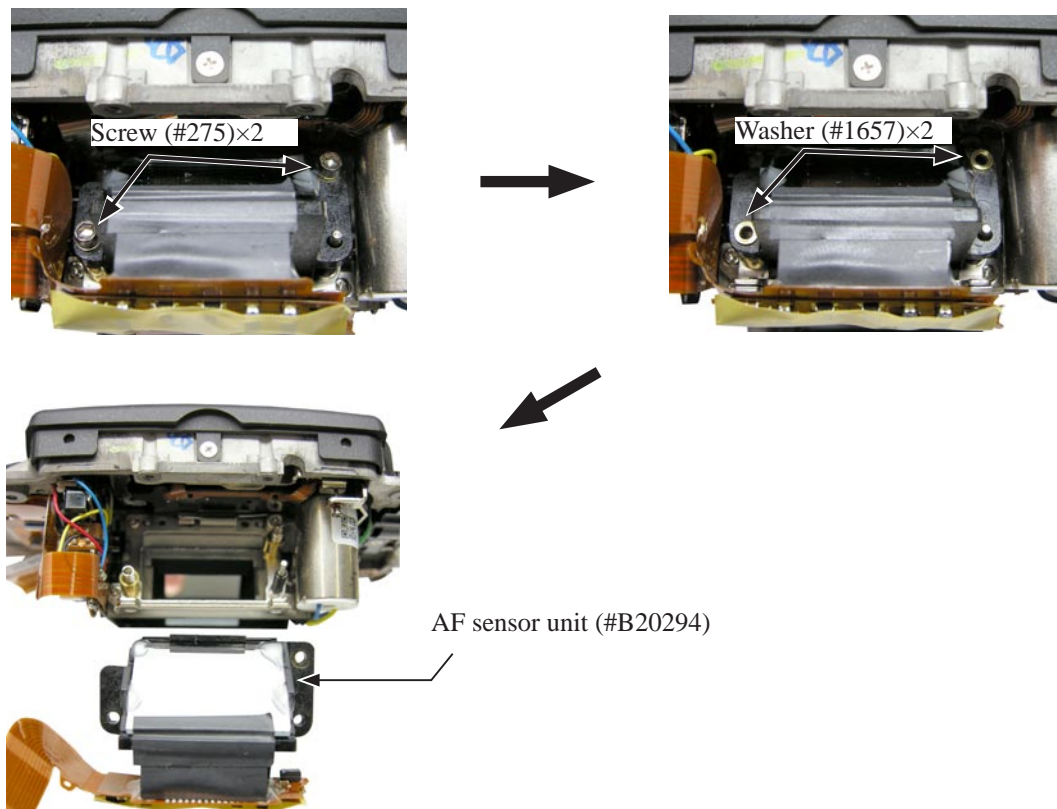

- Remove the spring (#273).
- Remove the two springs (#276).

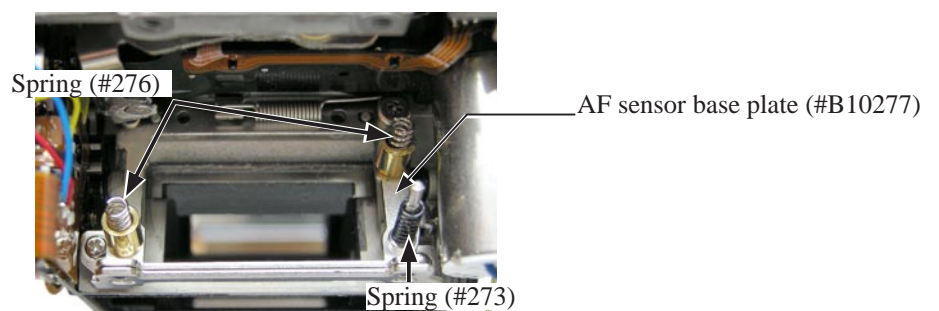

- Take out the screw (#65).

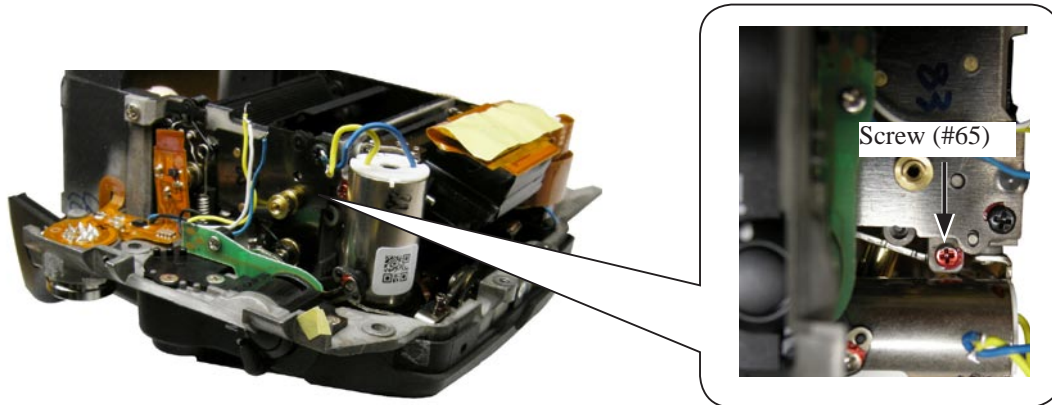

- Take out the screw (#283).
- Remove the Spring (#284).

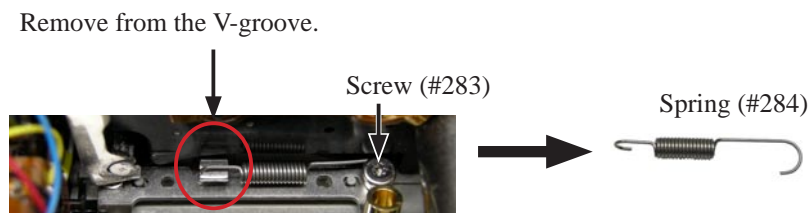

- Take out the three screws (#1509).
- Remove the AF sensor base plate (#B10277).

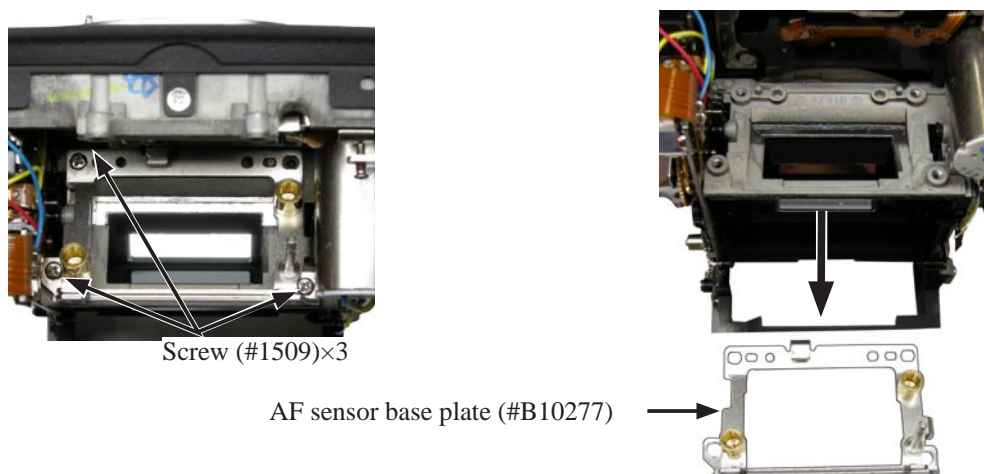

Bayonet

- Take out the screw (#1620) and the four screws (#1621).
- Remove the bayonet mount (#401).



- Remove the bayonet mount spring (#402).



Separation of Front cover from Front body

- Remove the cover ring (#388).
- Take out the screw (#387), and remove the SCM changeover lever (#383).

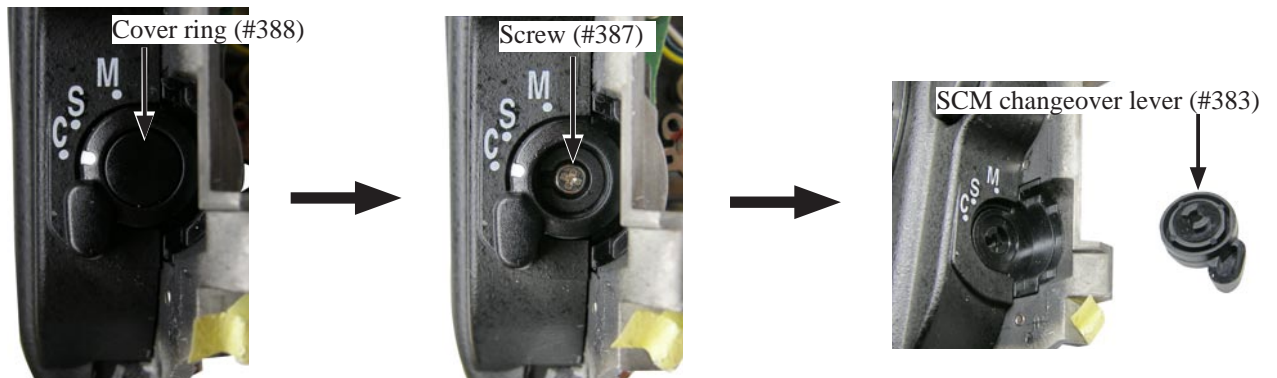

Cover ring (#388)



Double stick-tape (#389)

- Take out the two screws (#1518) and the three screws (#55).

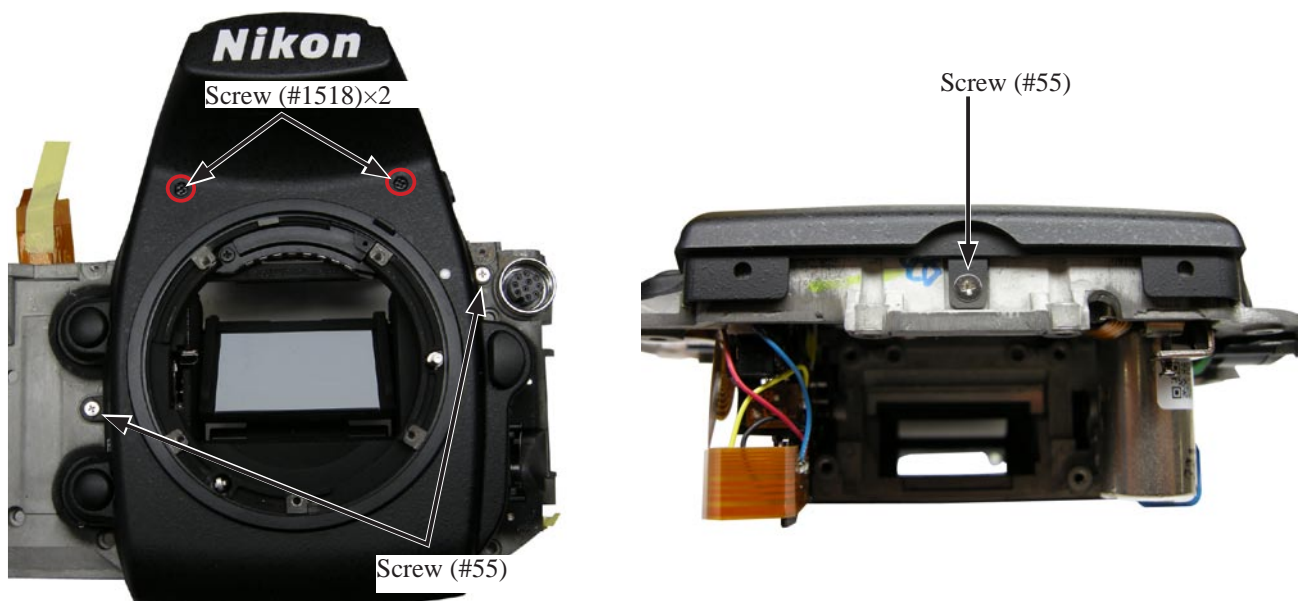

- Remove the apron (#22) from the front body unit (#B26RP).



Front cover

- Remove the roller (#407). Then remove the spring (#406) by separating from boss and roller.

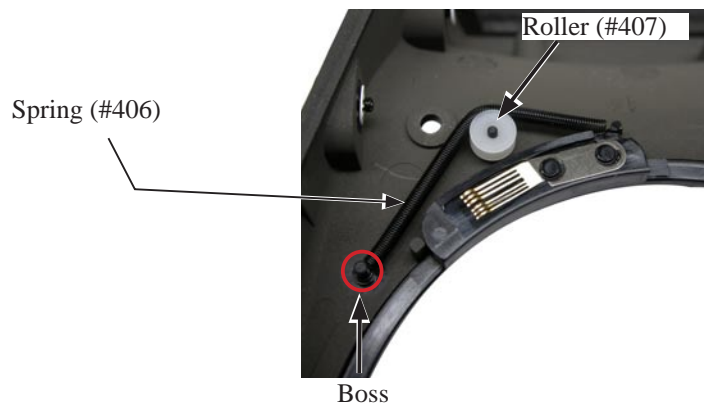

- Remove the aperture coupling ring unit (#B404RP).
- Remove the Sponge (#916).
- Remove the Sponge (#992).

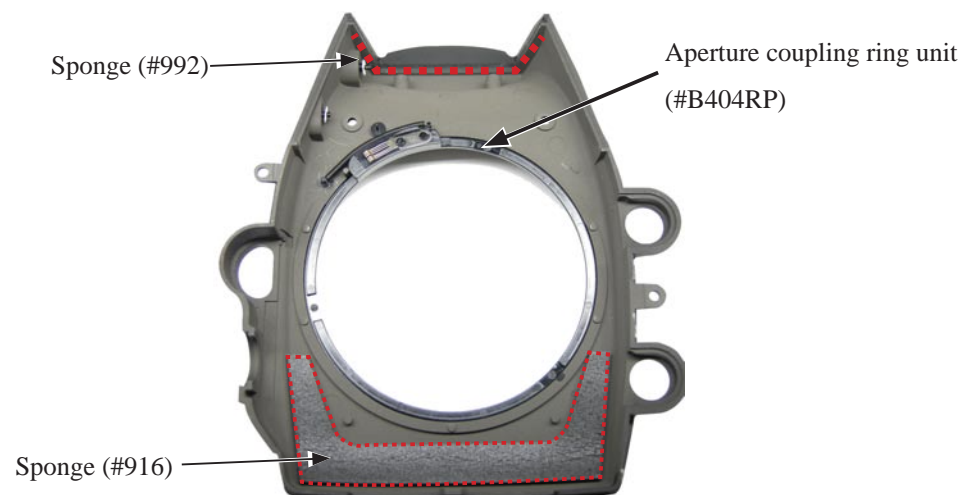

- Remove the two retainer rings (#38).
- Remove the SB pop-up button (#40), sync mode button (#37).

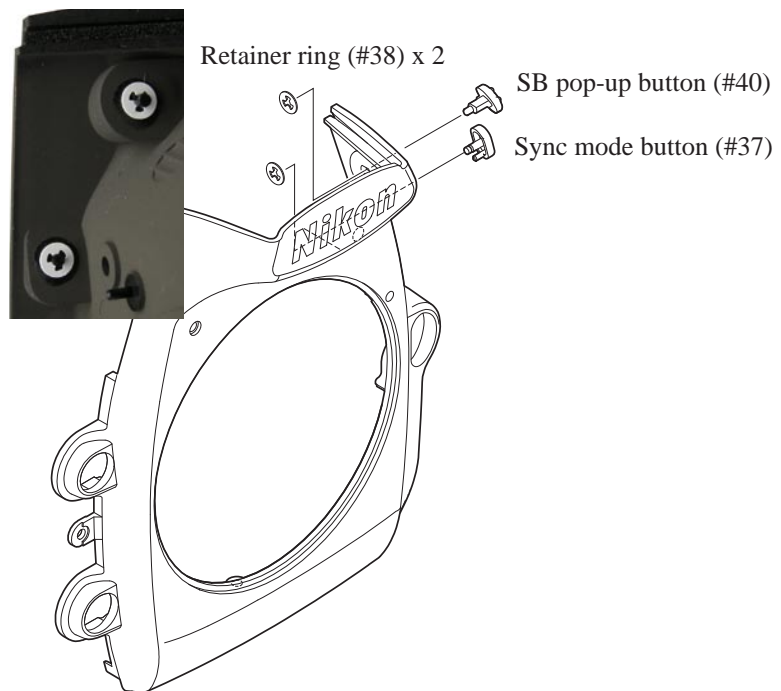

Release button

- Take out the screw (#1516) and the three screws (#66).

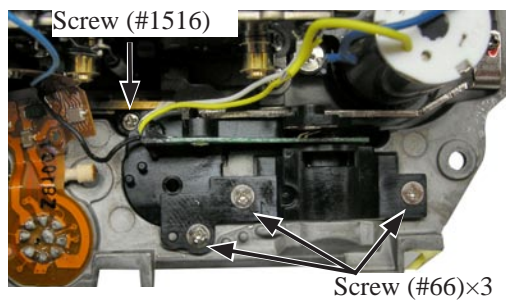

- Remove the release base unit (#B381).

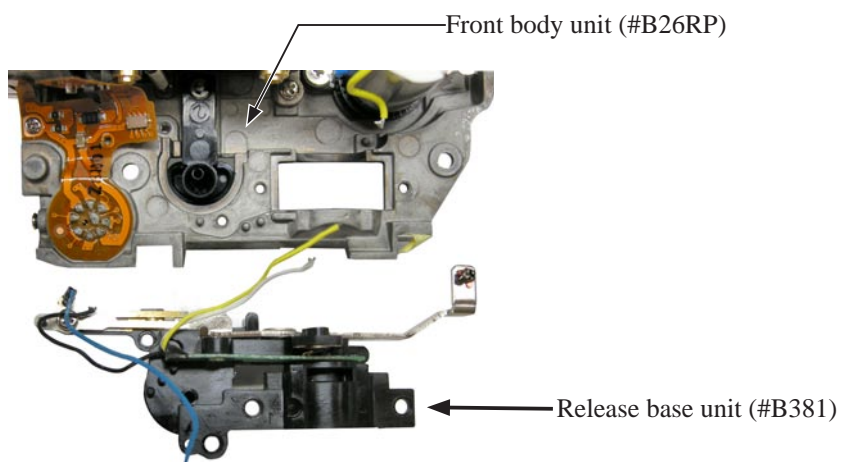

- Remove the spring (#377) and release button unit (#B376).

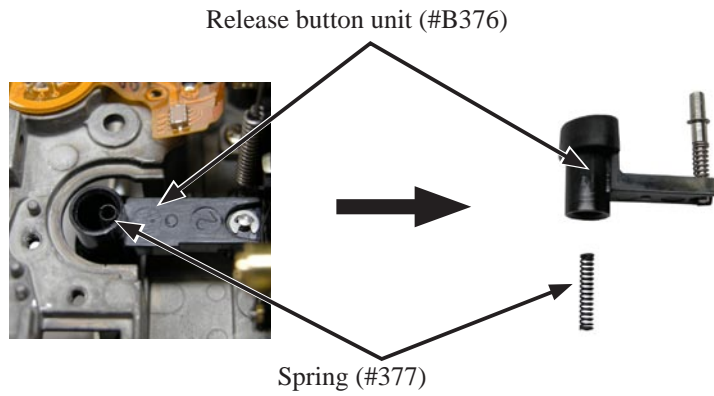

Separation of Mirror box and Front body

- Remove the FPCs' solders of the I-base plate unit (#B71) and those of the AF driving base unit (#B10328).

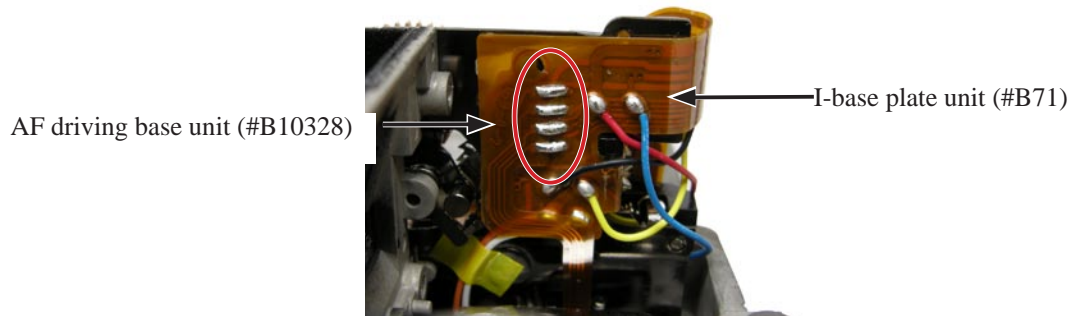

- Take out the screw (#1503).
- Disconnect the FPC from the connector.

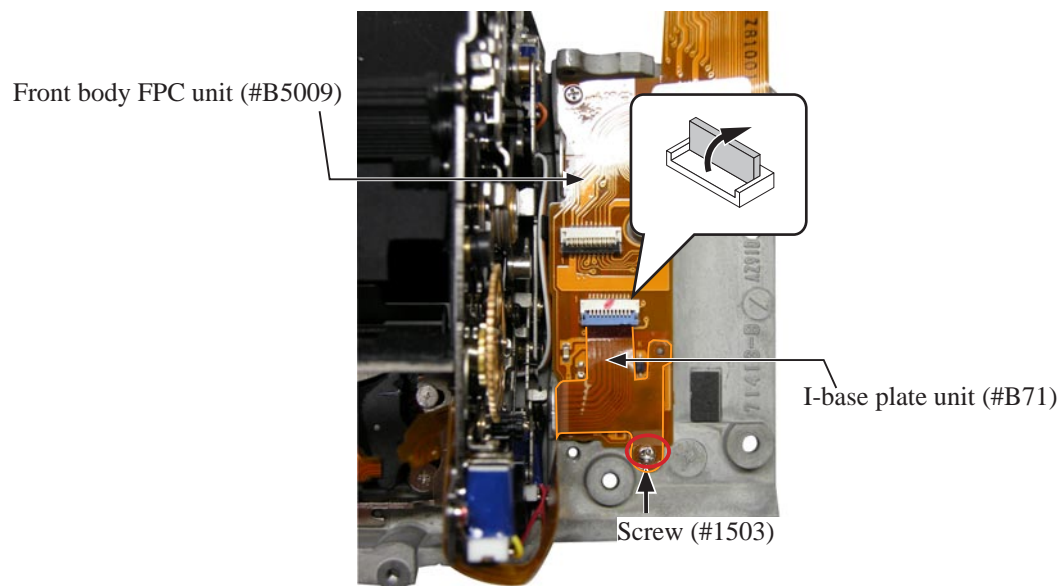

- Take out the two screws (#1523), three screws (#1524), and the screw (#1530) as below.

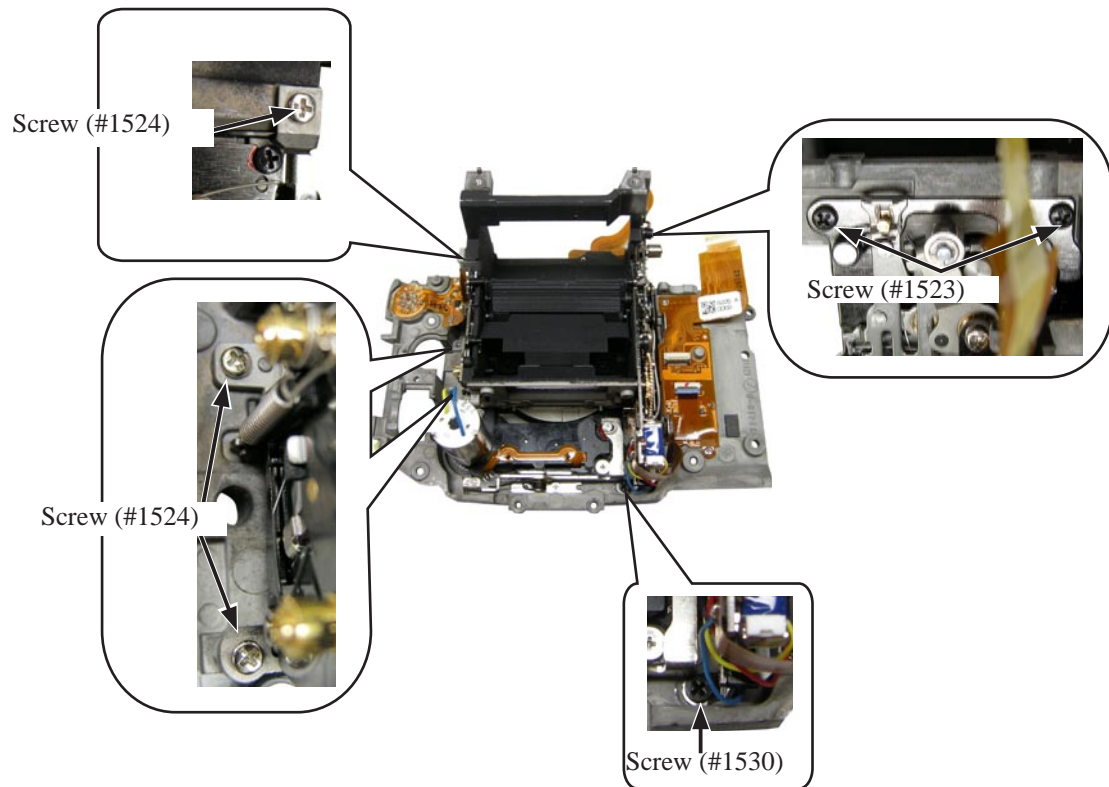

- Remove the mirror box unit.

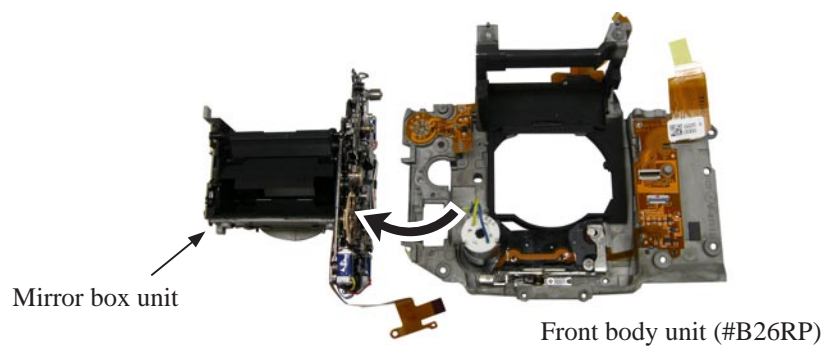

10-pin FPC

- Remove the solders of the 10-pin FPC (#5010).



Remove solders here.

10-pin FPC (#5010)

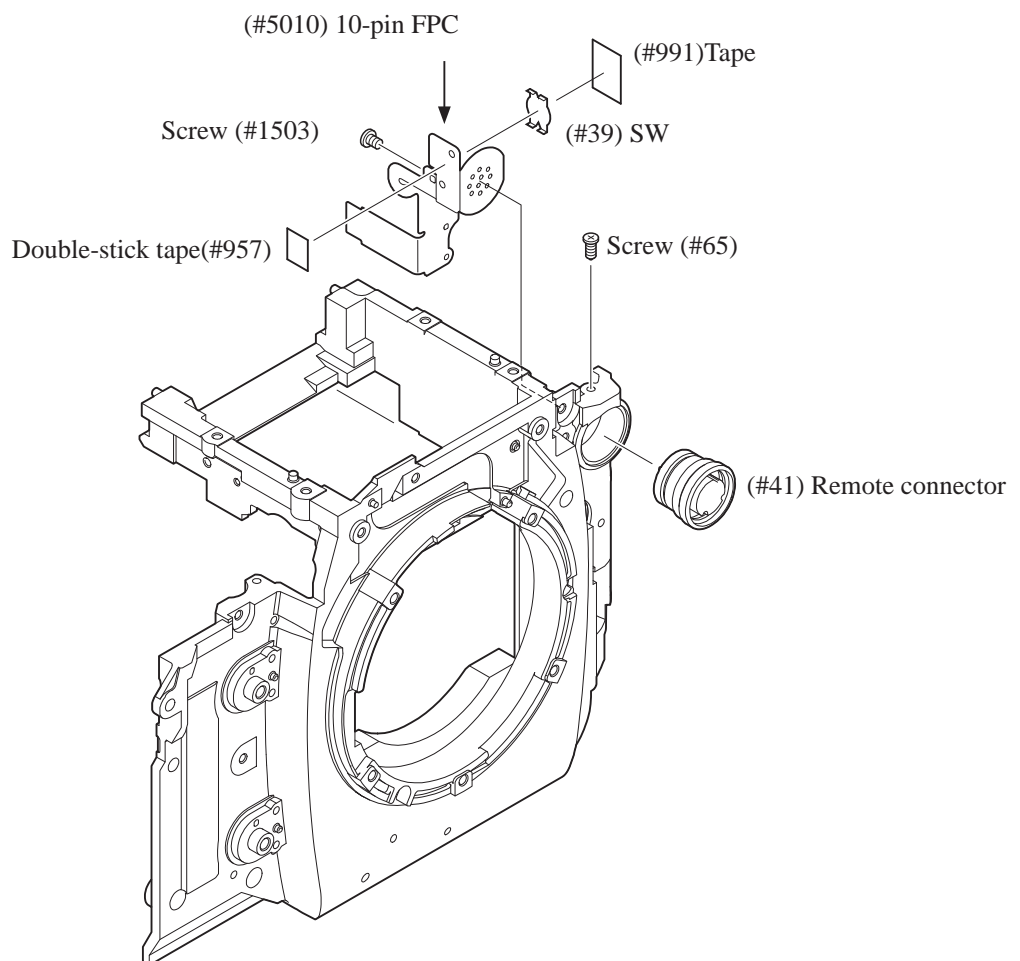

AF driving base unit

- Take out the screw (#1513).

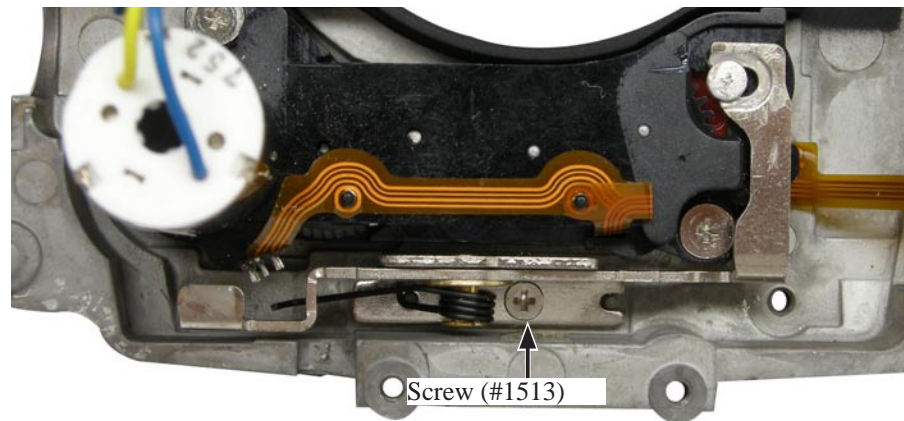

- Remove the side lever unit (#B355).

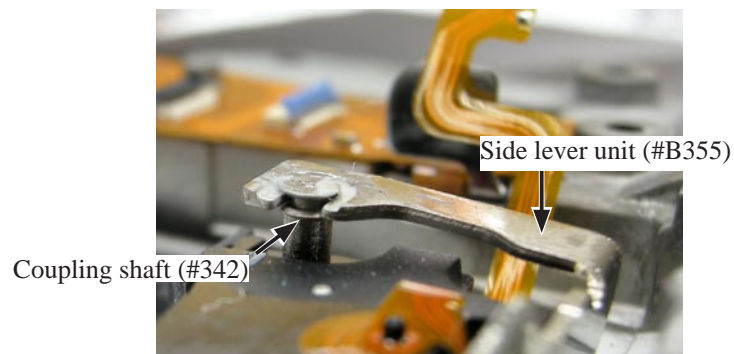

- Pull the Coupling shaft (#342) from the shaft hole.

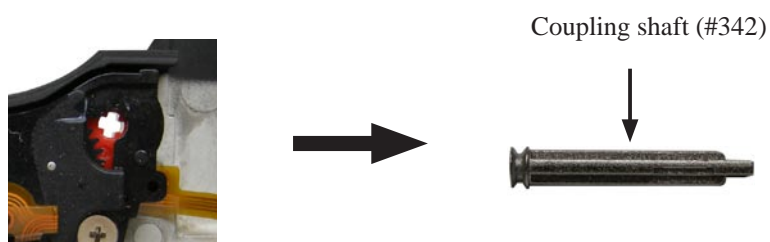

- Take out the two screws (#347).
- Remove the AF driving base unit (#B10328).

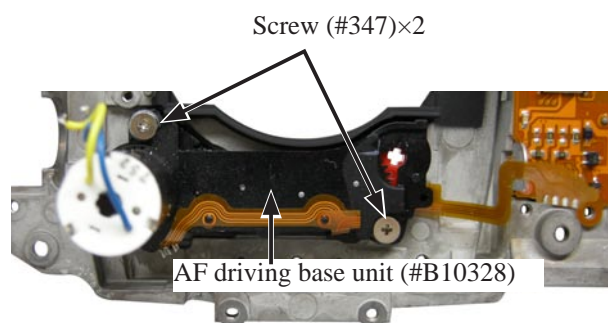

Function button

- Take out the screw (#1503).
- Remove the front body FPC unit (#B5009).

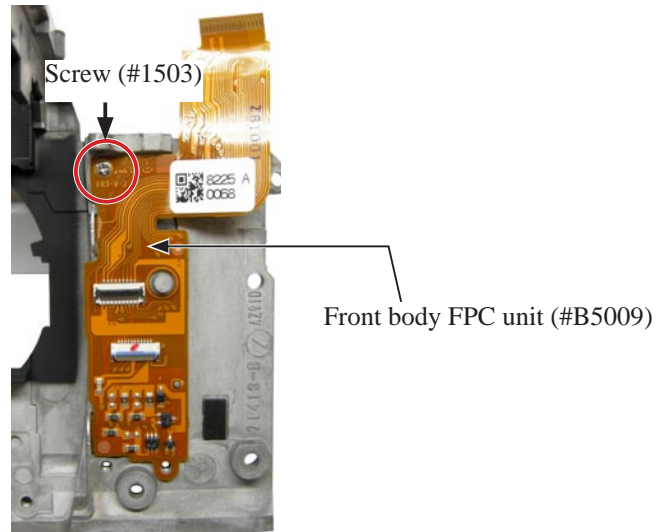

- Flick up the front body FPC unit (#B5009), so that the backing plate (#35) can be seen. Then, take out the four screws (#1510).

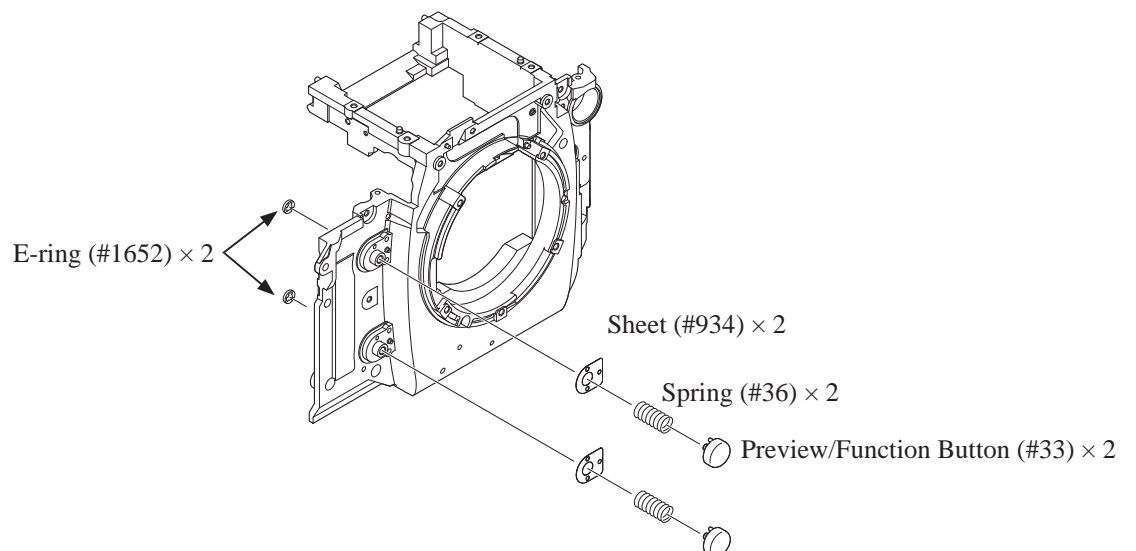
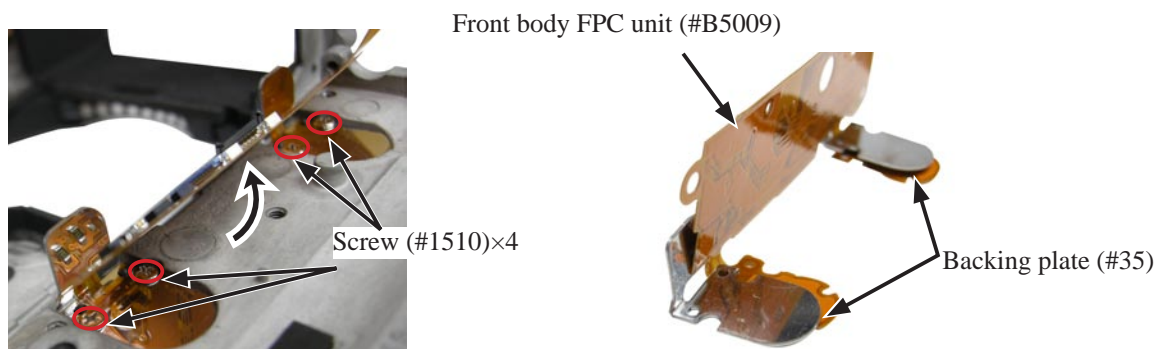

Lens contact

- Remove the solders that joint the lens contact unit (#B5008) and F-F0 base plate unit (#B5024).
- Remove the F-F0 base plate unit (#B5024).
- Take out the screws (#1521 and #1615), and remove the lens contact unit (#B5008).

Lens contact unit (#B5008)

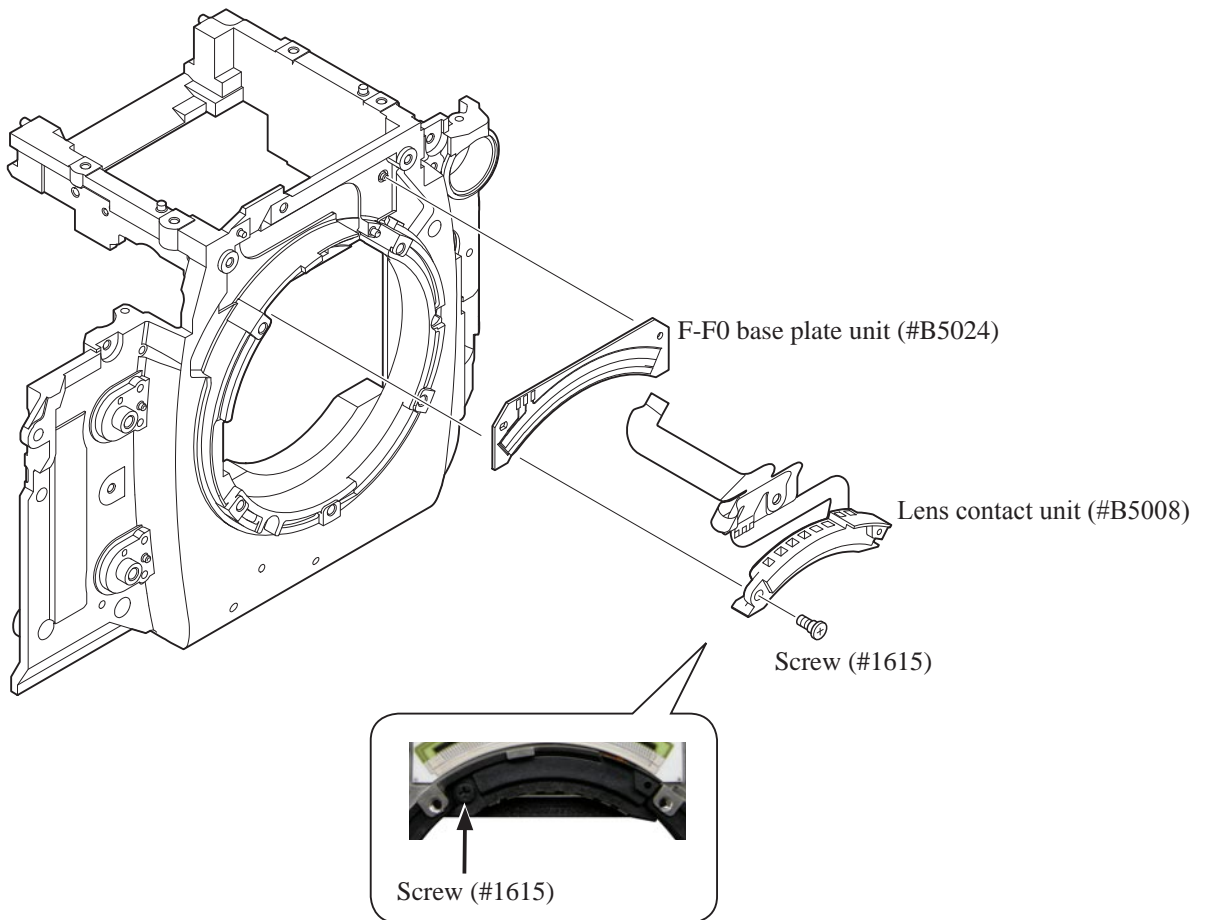
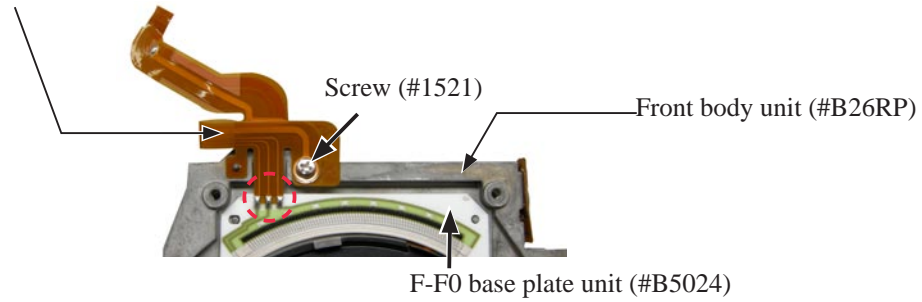

- Remove the sponge (#206).

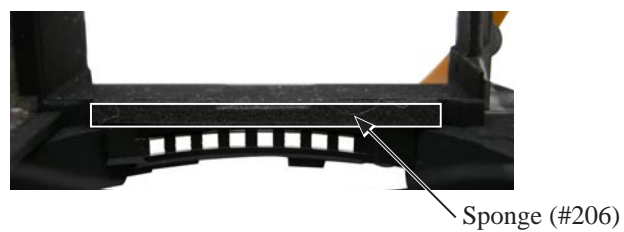

Front body accessories

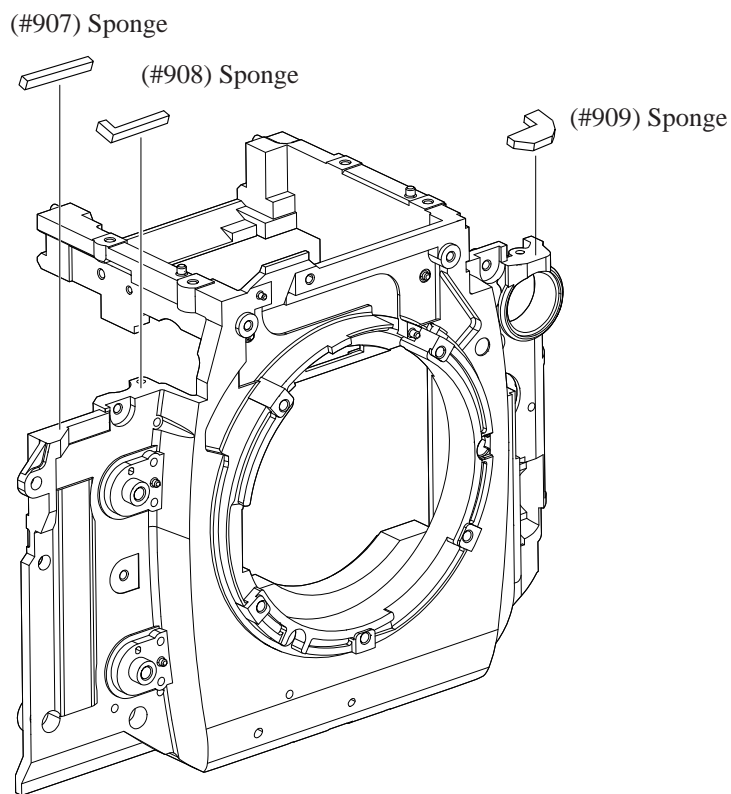

Mirror box

Be careful NOT to lose the washer (#221).

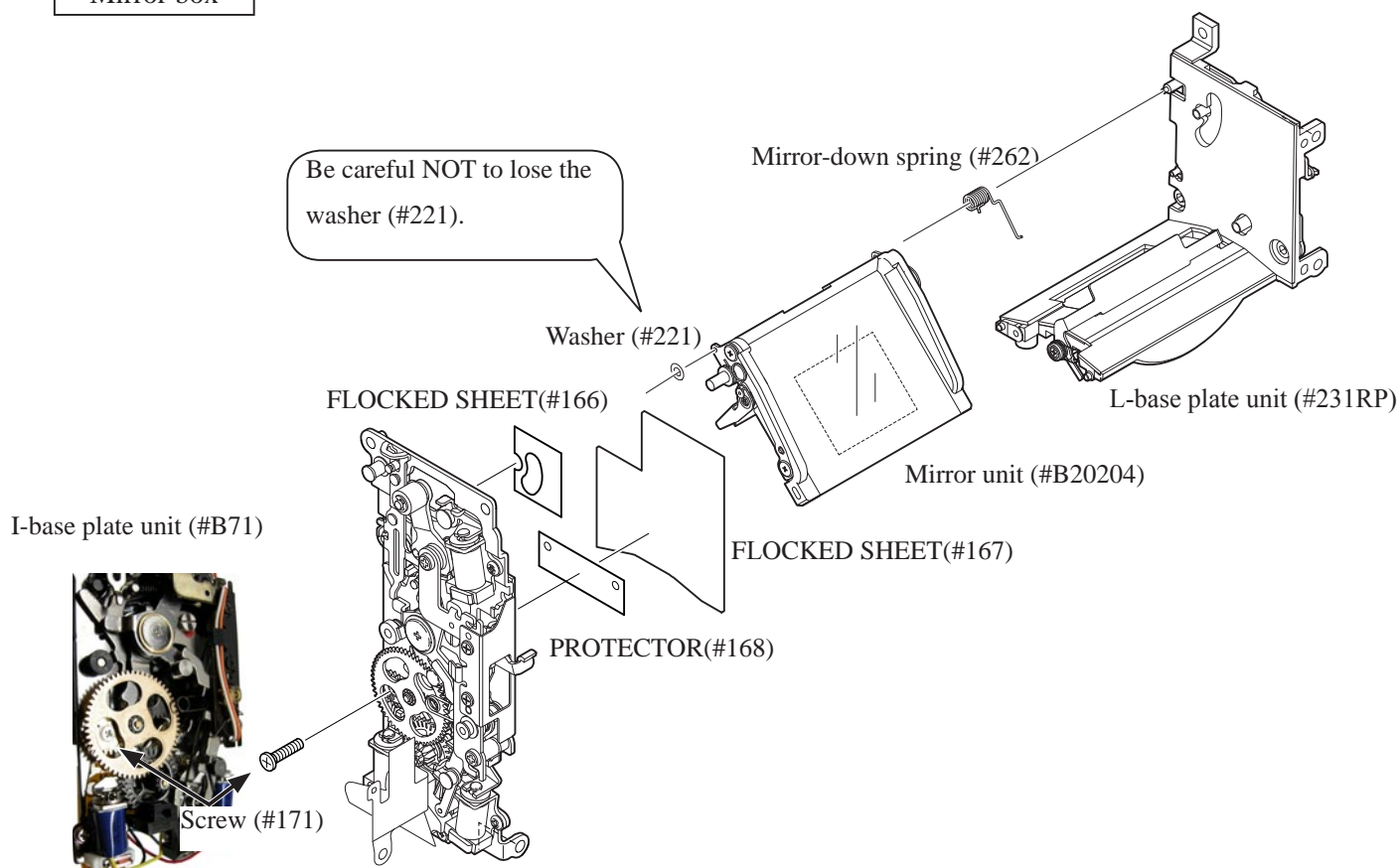

7. Rear body

IF PCB

- Take out the two screws (#1510).

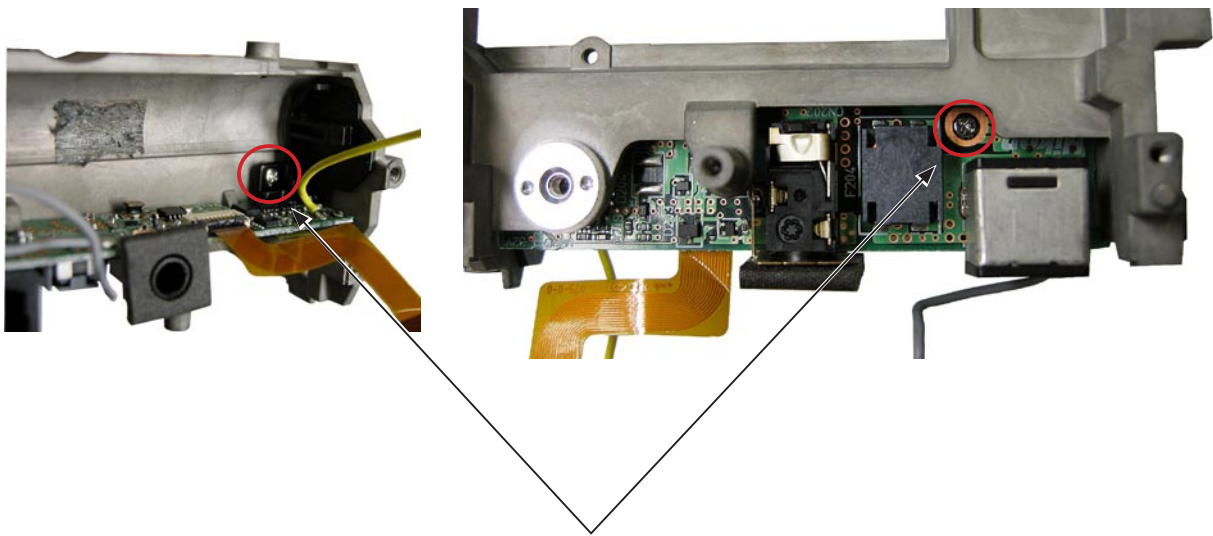

- Remove the IF PCB (#5019).

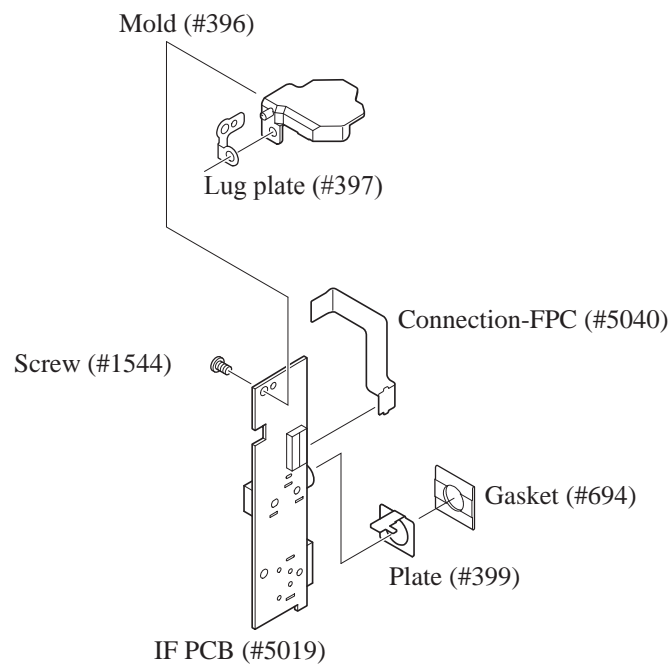
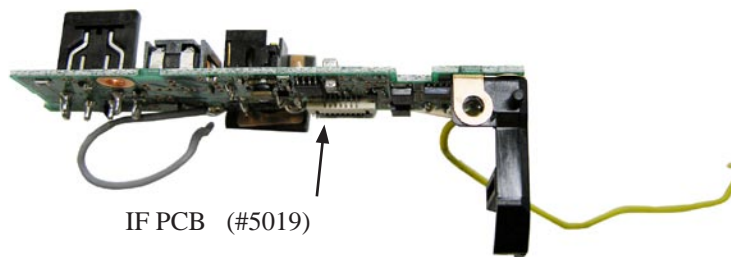

Piezoelectric buzzer

- Remove the Buzzer (#5065).

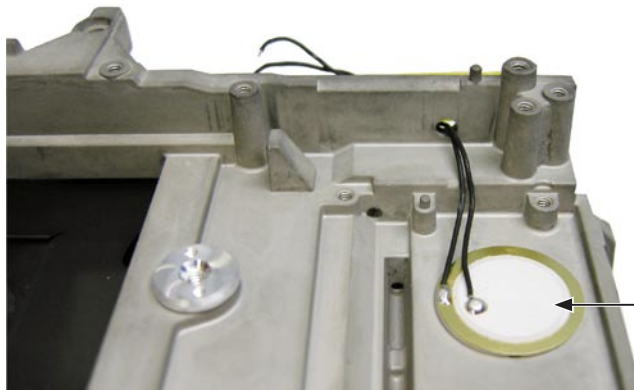

Buzzer (#5065)

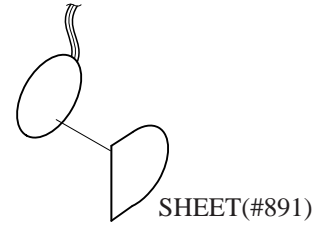

Buzzer (#5065)

- Peel off the tape [#TA-0005 (10×20)].

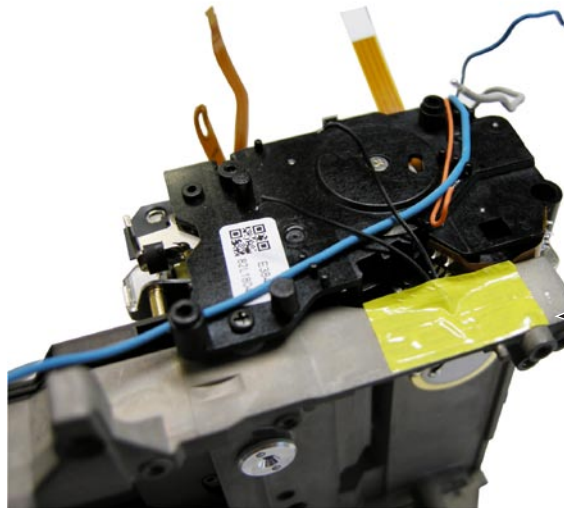

Tape (#TA-0005)

Charge base plate unit

- Take out the four screws (#1573).

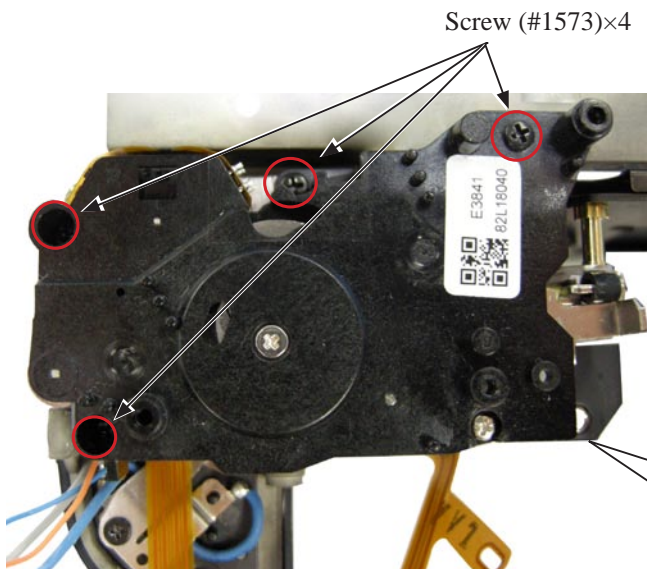

Screw (#1573)×4

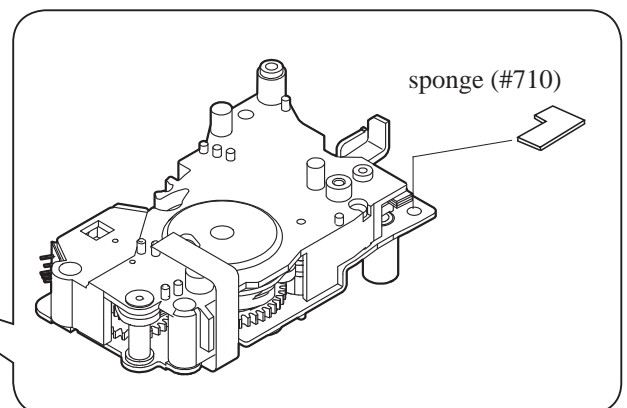

sponge (#710)

- Remove the charge base plate unit (#B620RP).

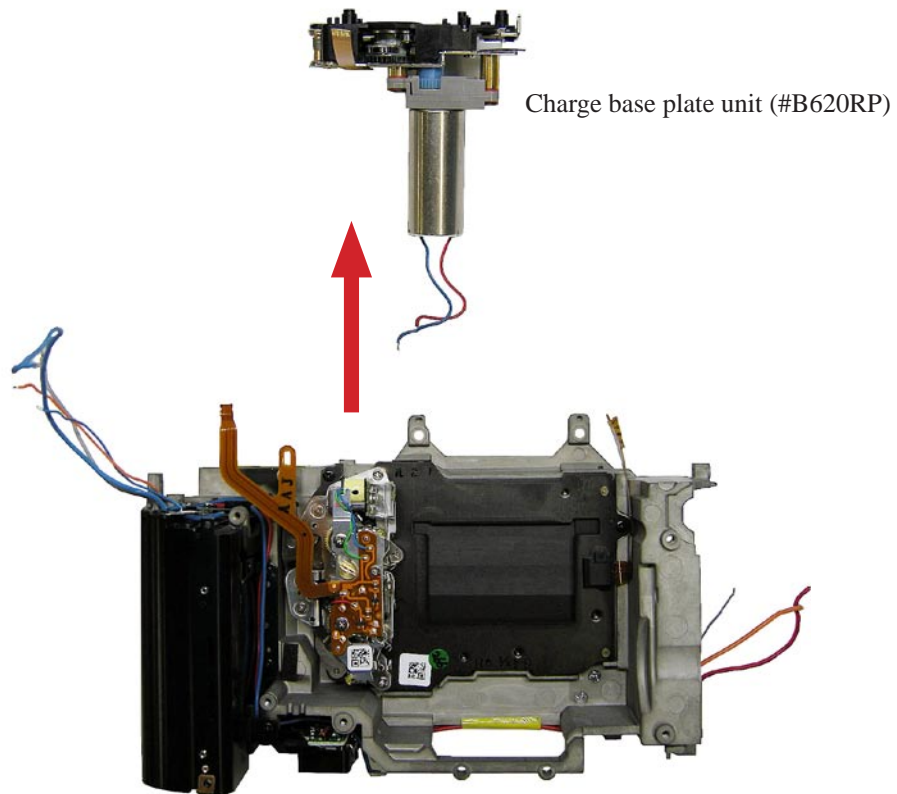

- Take out the two screws (#606), and remove the charge motor unit (#B602).

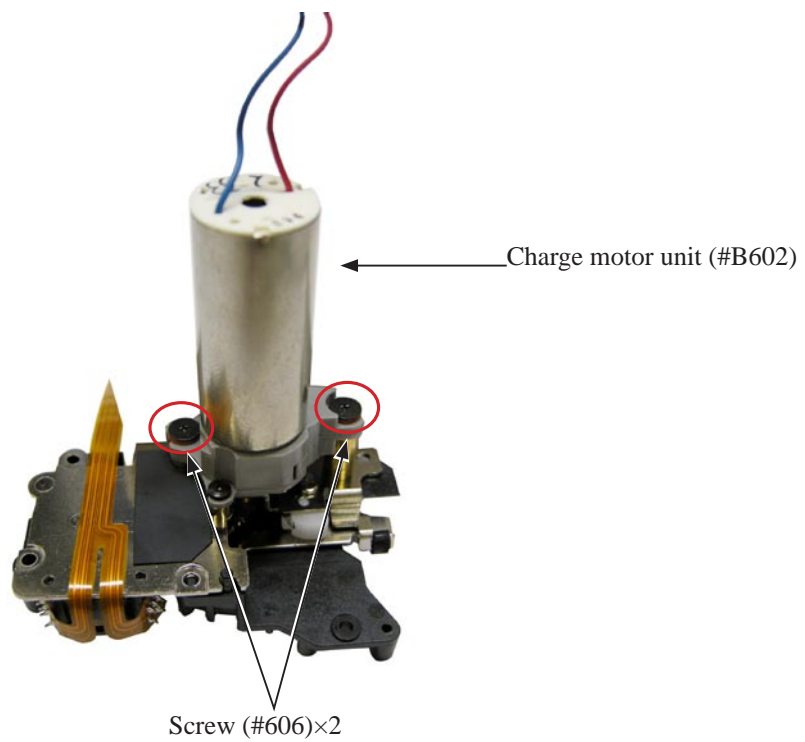

- Remove the gear (#614).
- Peel off the Sheet (#825).

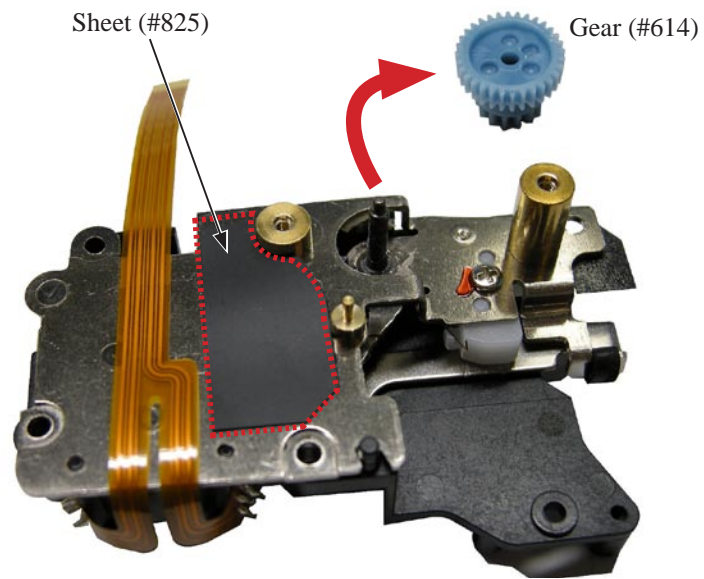

Shutter unit

- Take out the three screws (#1570).

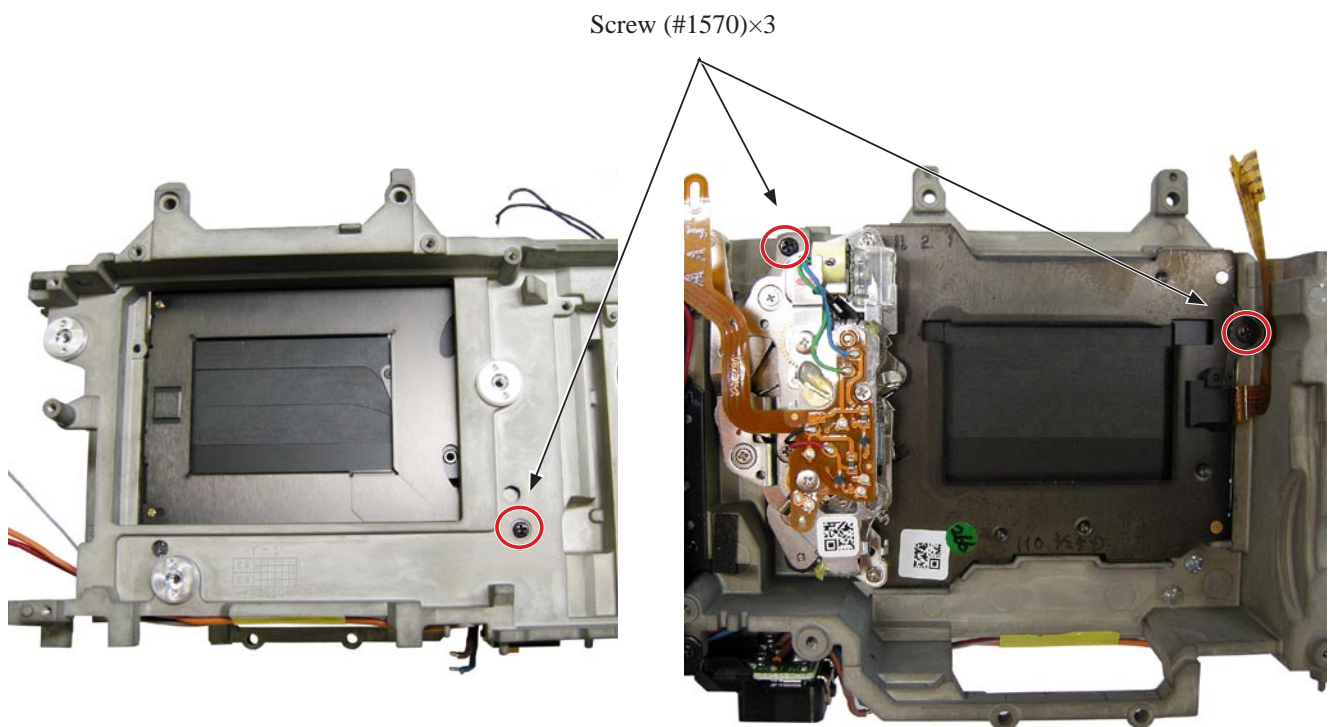

- Remove the shutter unit (#B12001).

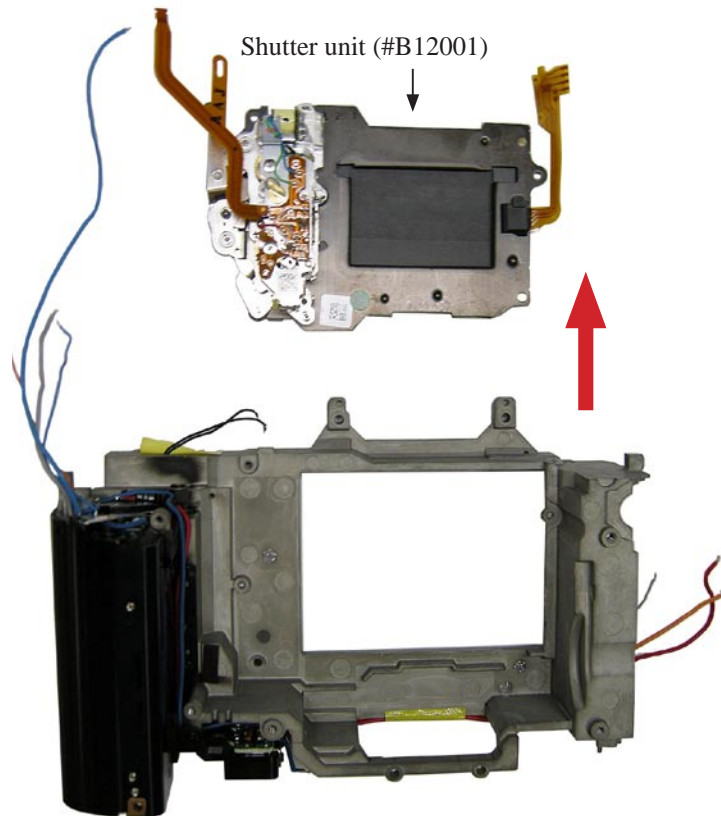

Power base unit

- Peel off the tape [#TA-0005 (10×20)].

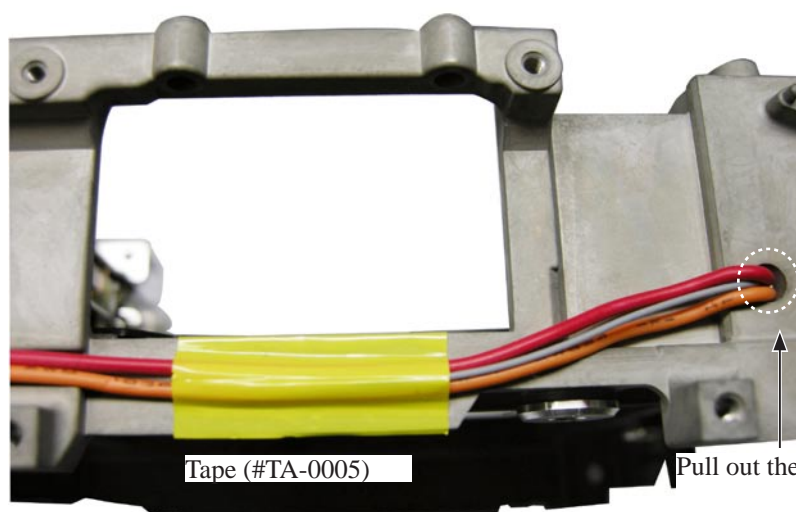

- Take out the three screws (#1516), and remove the base unit (#B812).

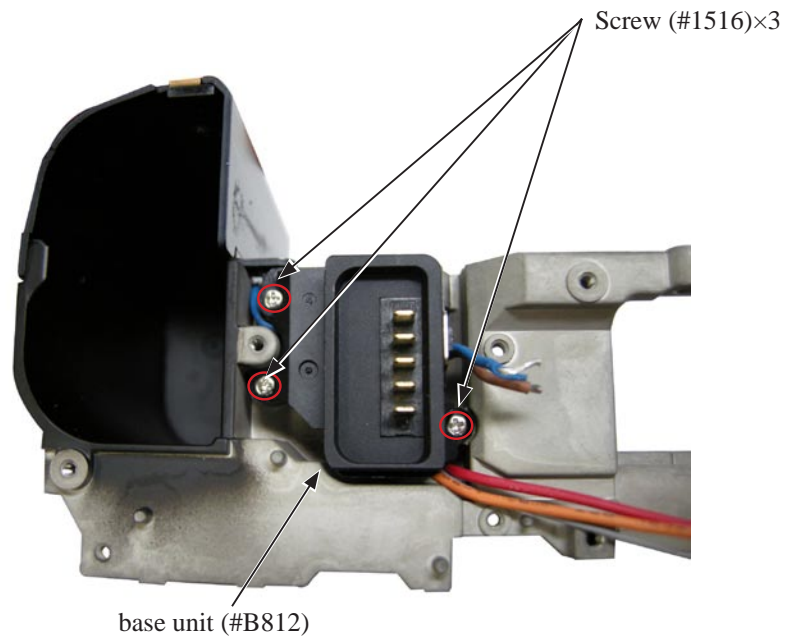

Grip unit

- Take out the three screws (#1534).

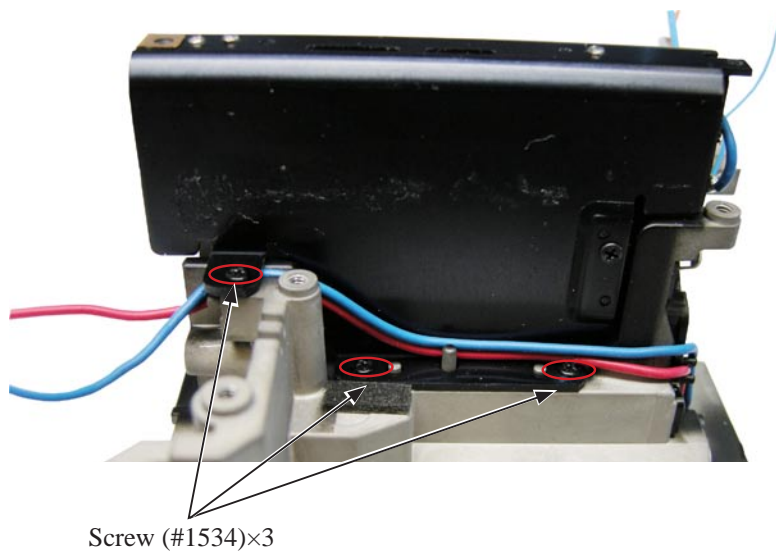

- Remove the grip unit (#B57).

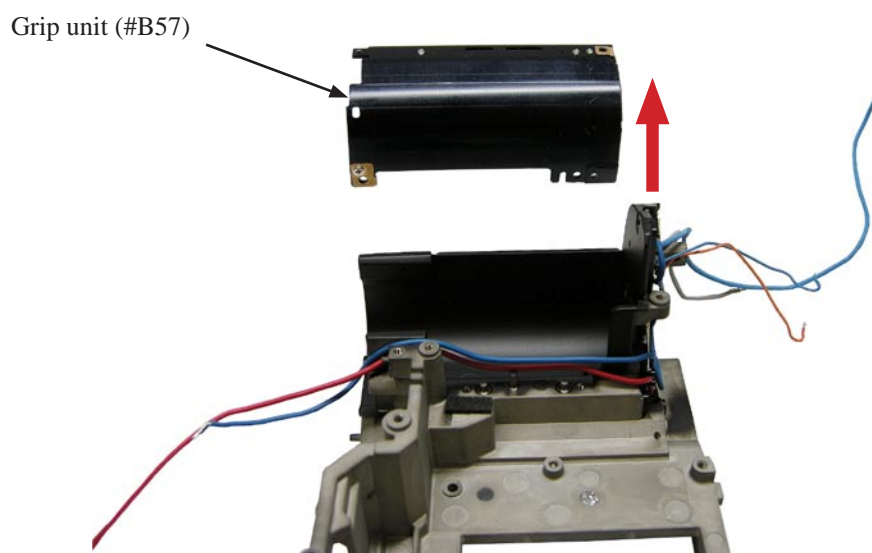

Battery contact mold

- Remove the battery contact unit (#B822).

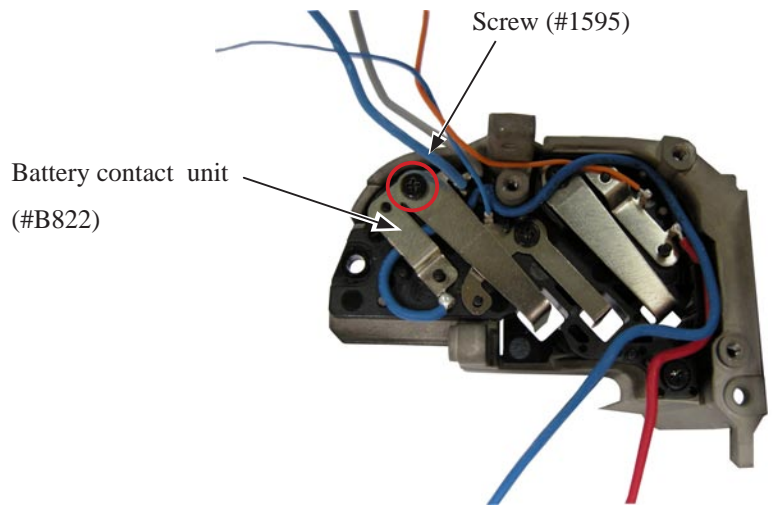

- Remove the FG contact unit (#B824).

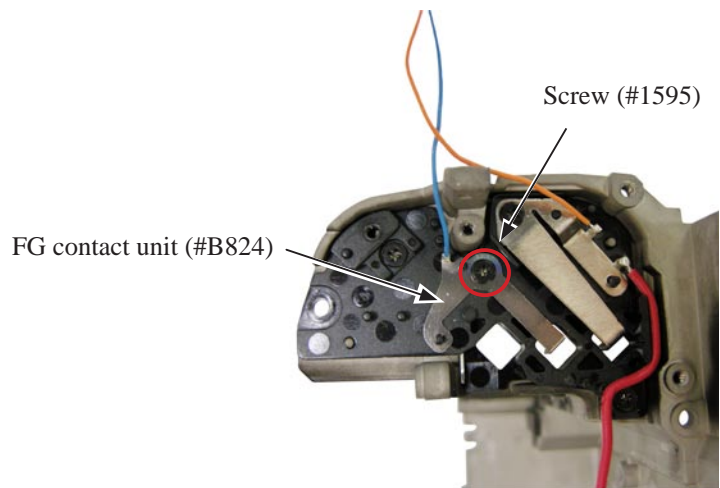

- Remove the battery contact unit (#B823).

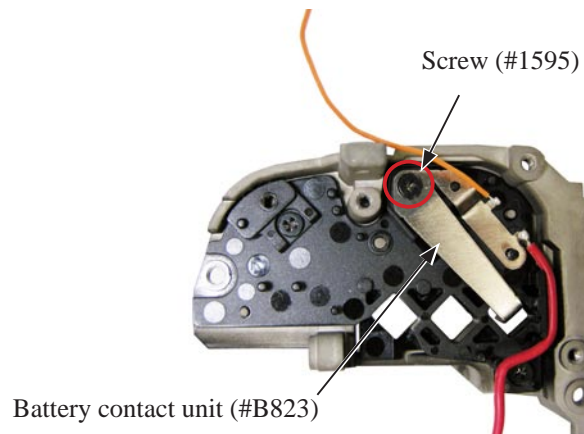

- Remove the Mold (#56).

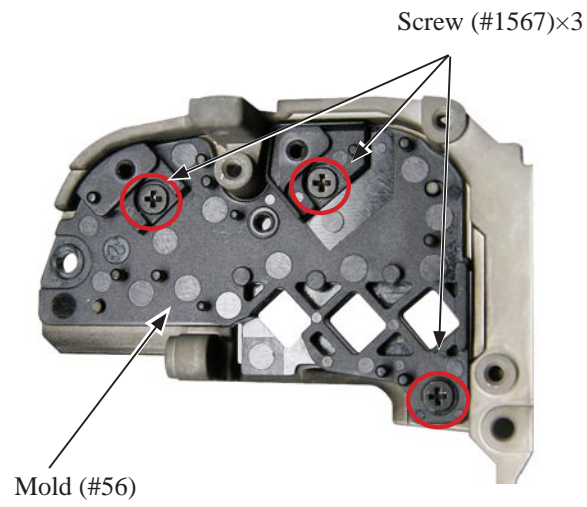

Rear body accessories

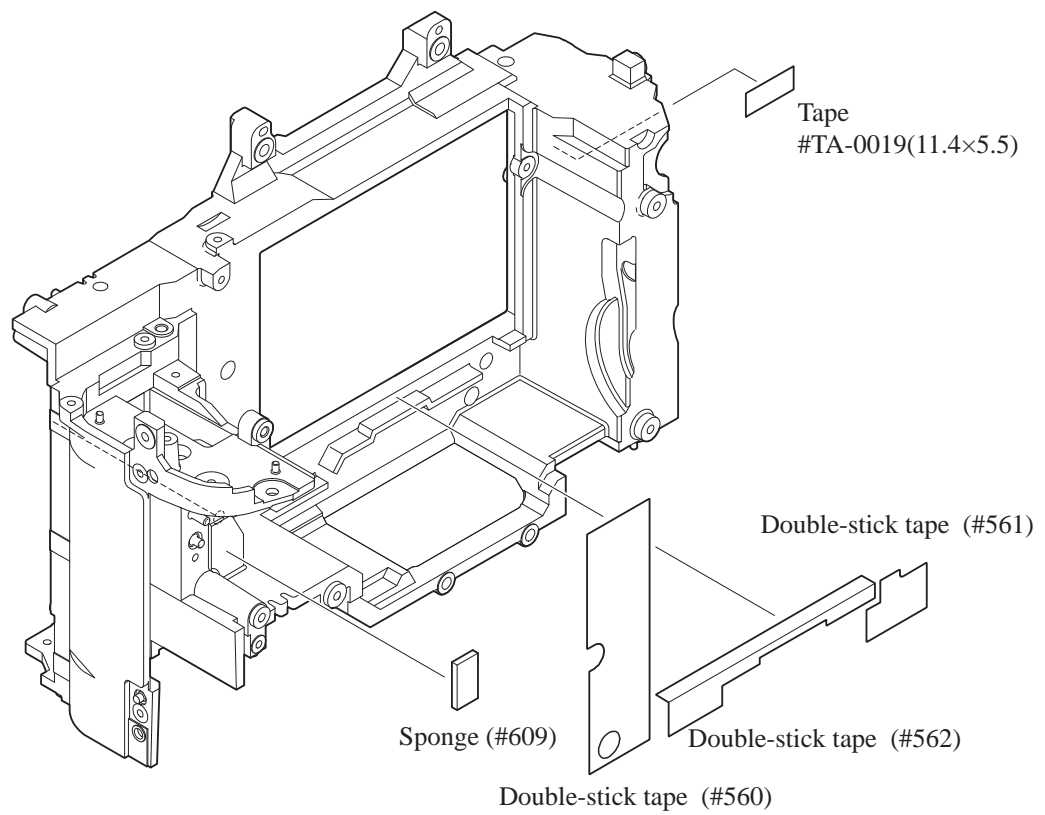

Assembly / Adjustment

1. Rear body

Rear body accessories

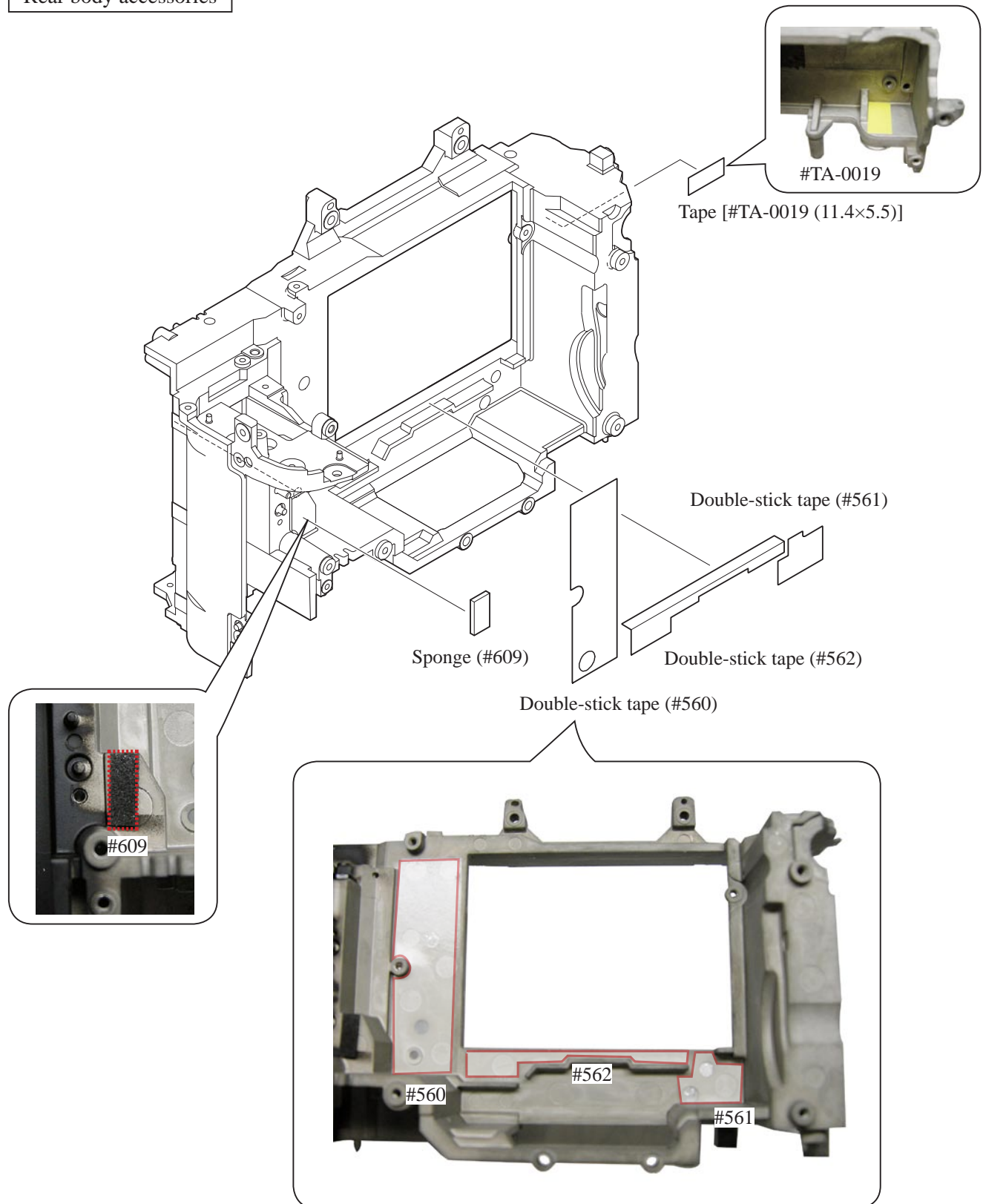

Battery contact mold

- Remove the mold (#56).
- Tighten the three screws (#1567).

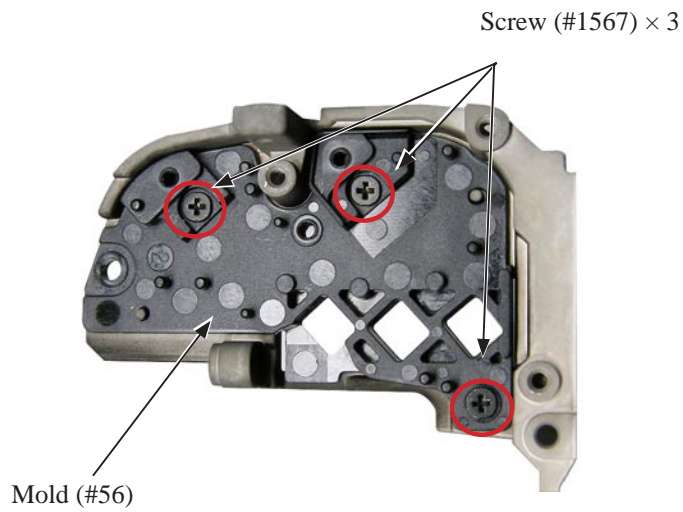

- Mount the battery contact B unit (#B823).
- Tighten the screw (#1595).

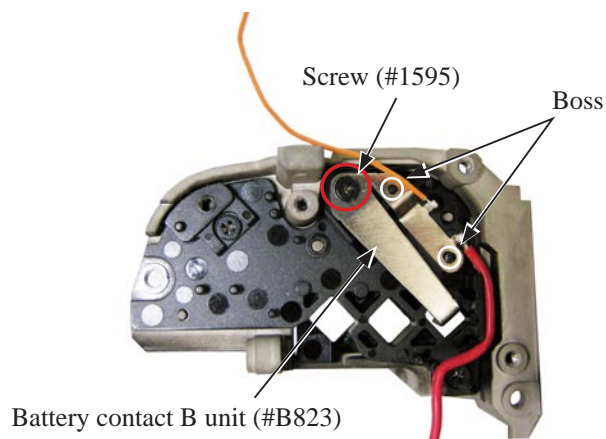

- FG contact unit (#B824).
- Tighten the screw (#1595).

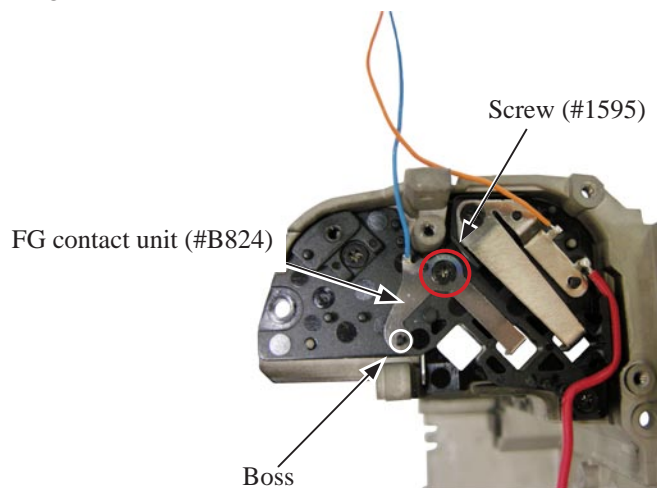

- Mount the battery contact unit (#B822).
- Tighten the screw (#1595).

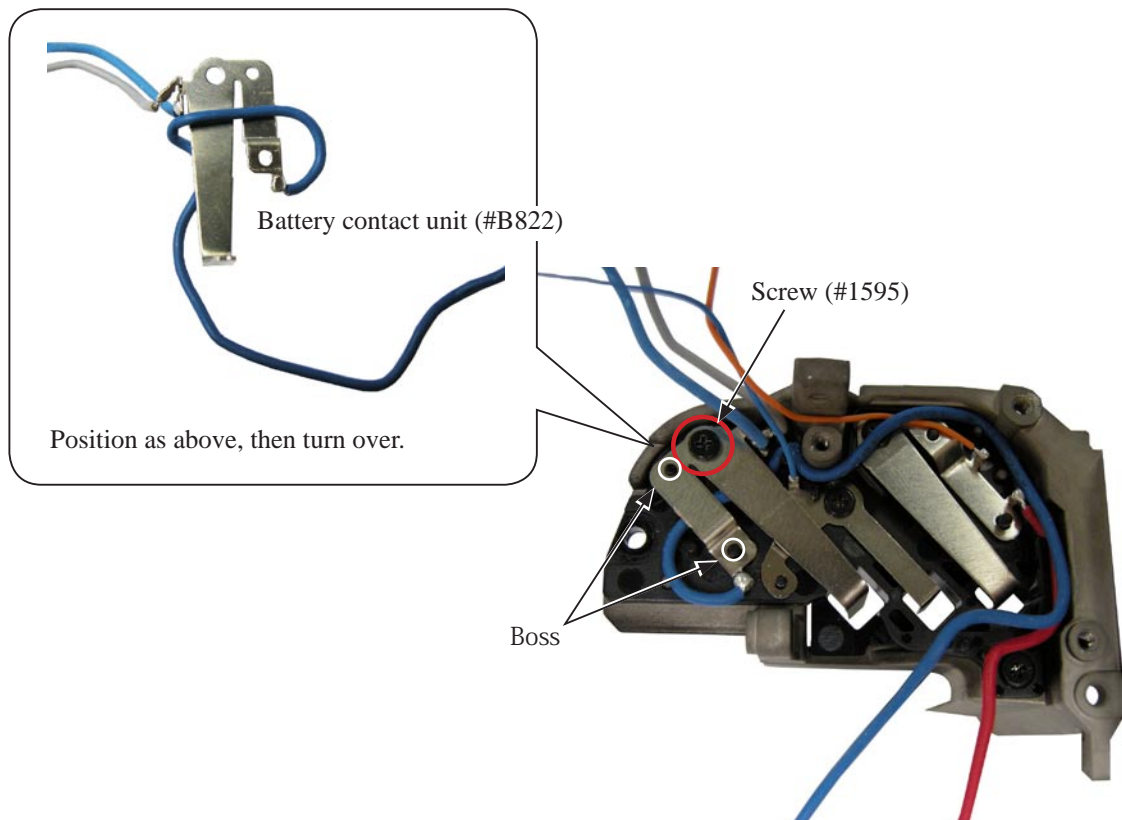

- Arrange the wires as below.

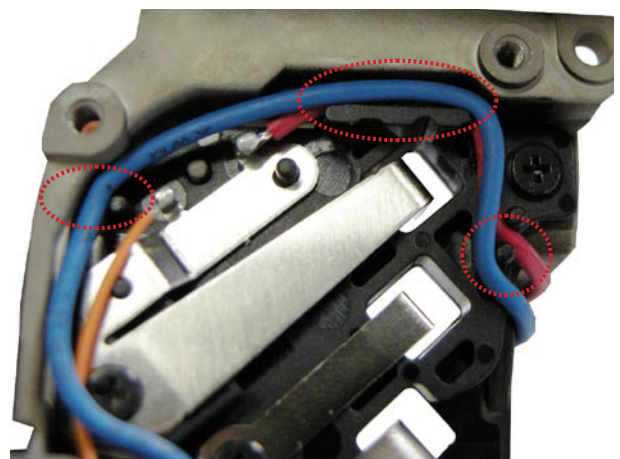
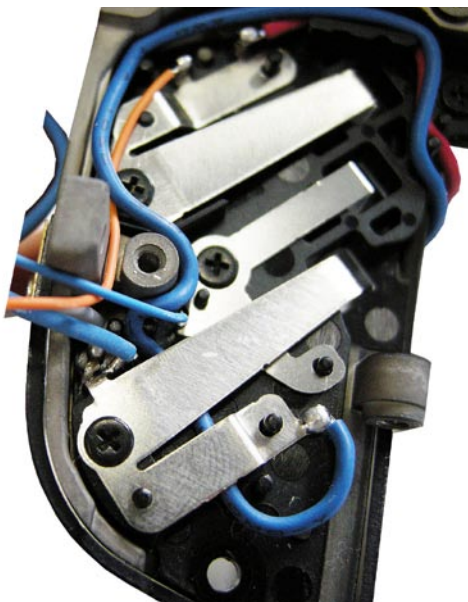

Put between bosses for arrangement as above.

Grip unit

- Mount the grip unit (#B57).

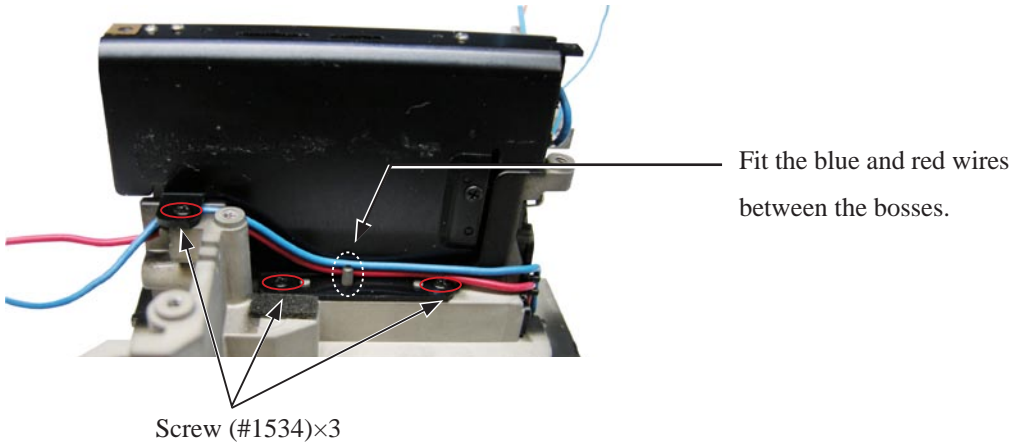
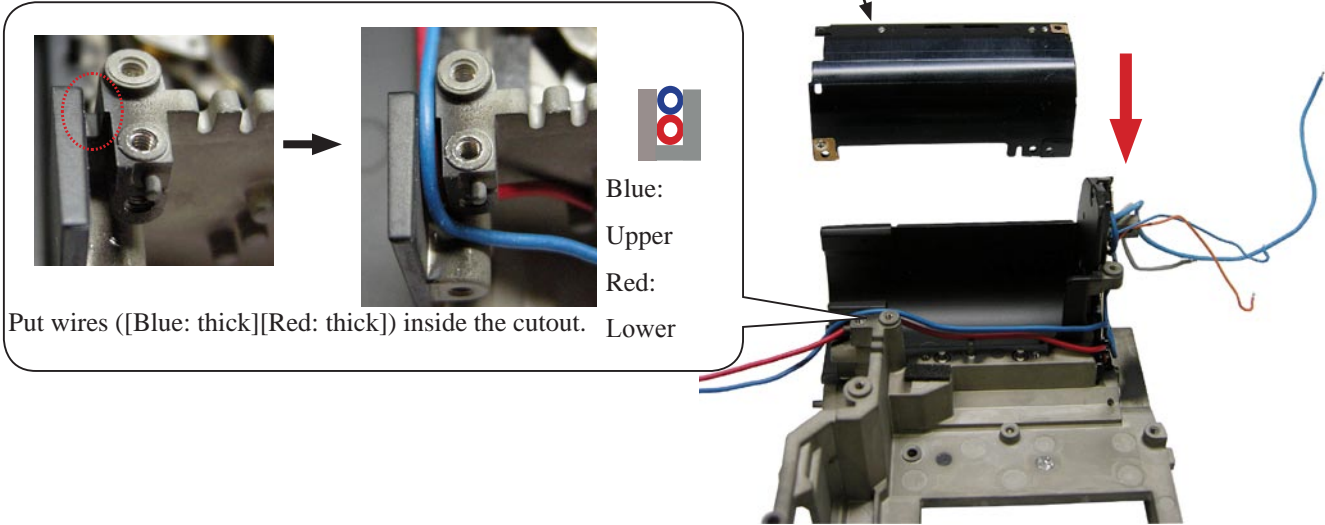

- Arrange the wires as below.

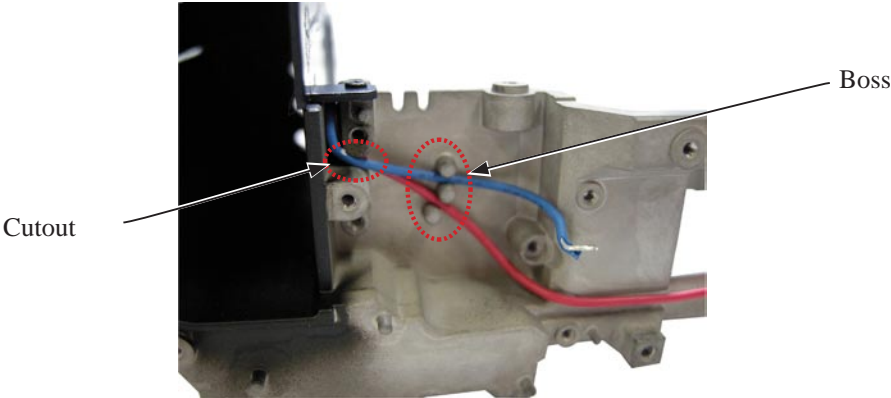

Power base unit

- Mount the power base unit (#B812).

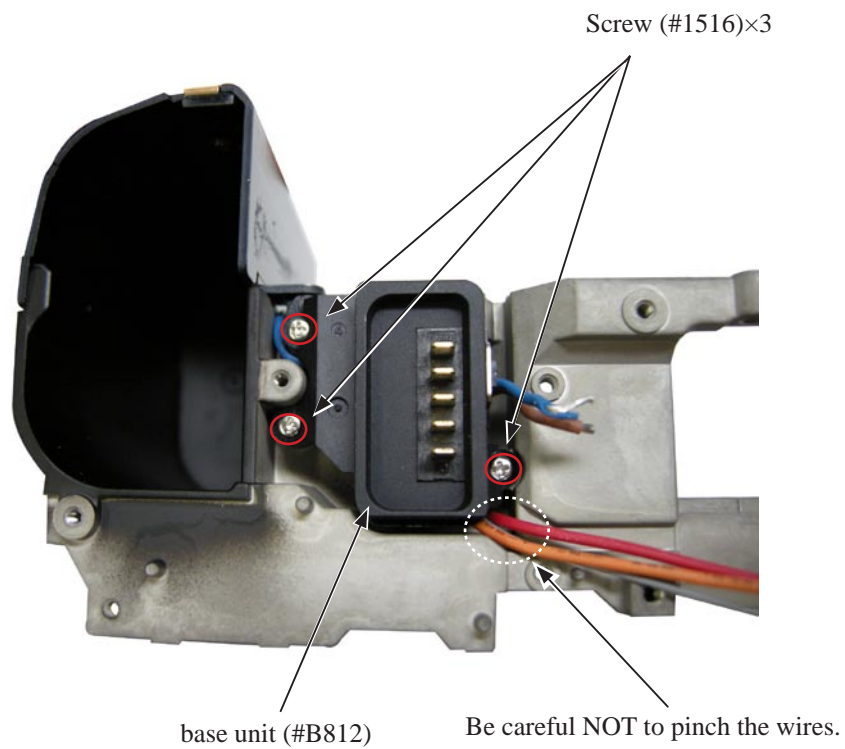

- Attach the tape [#TA-0005(10×20)].

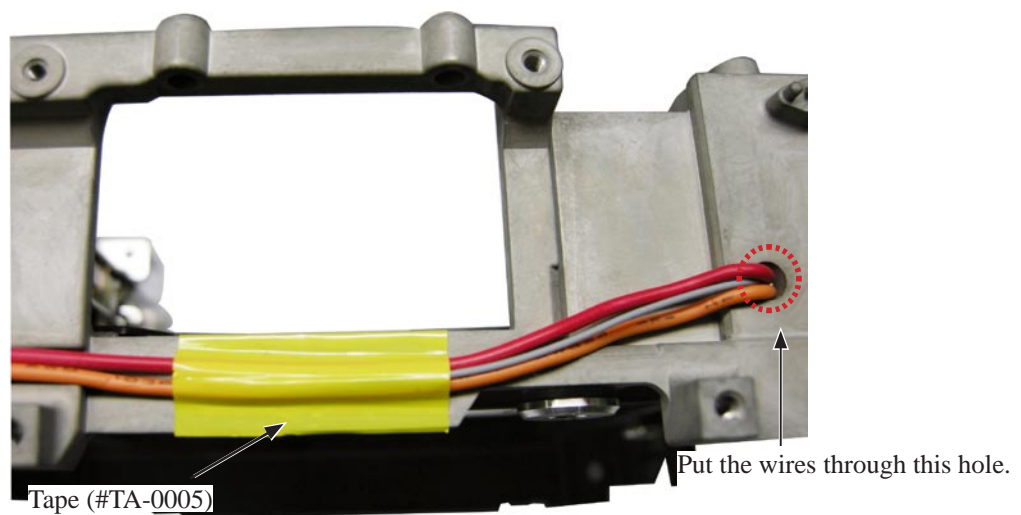

Shutter unit

- Mount the shutter unit (#B12001).

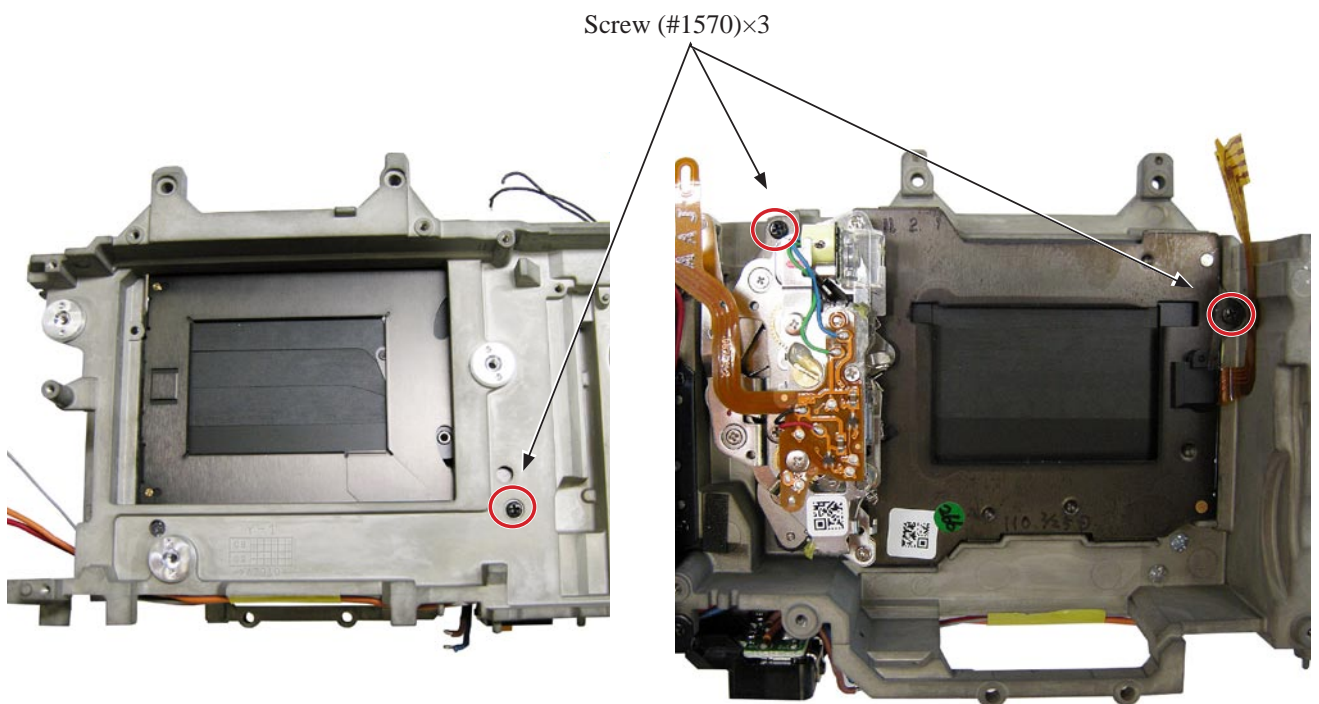
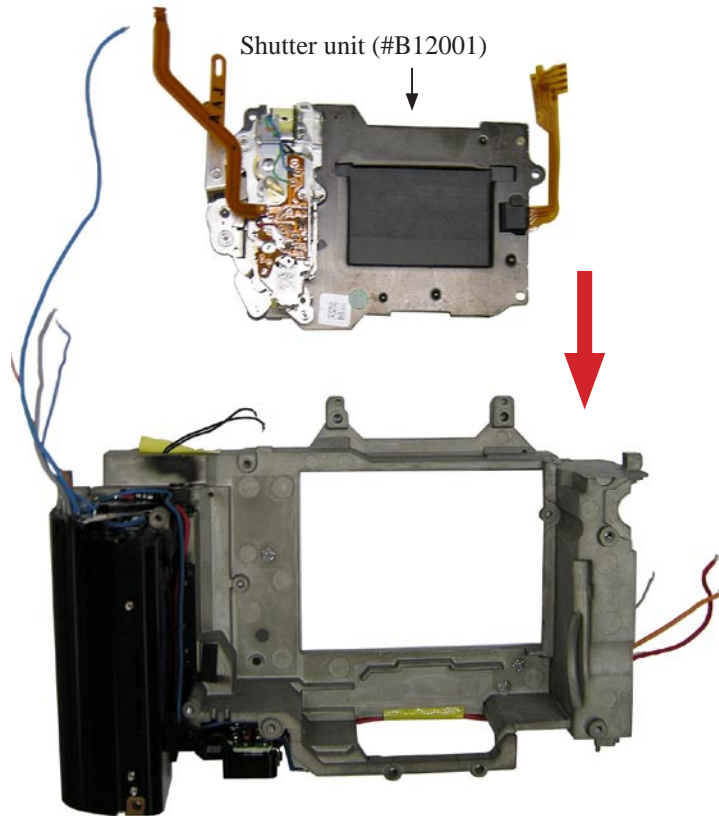

Charge base plate unit

- Attach the gear (#614).
- Attach the Sheet (#825).

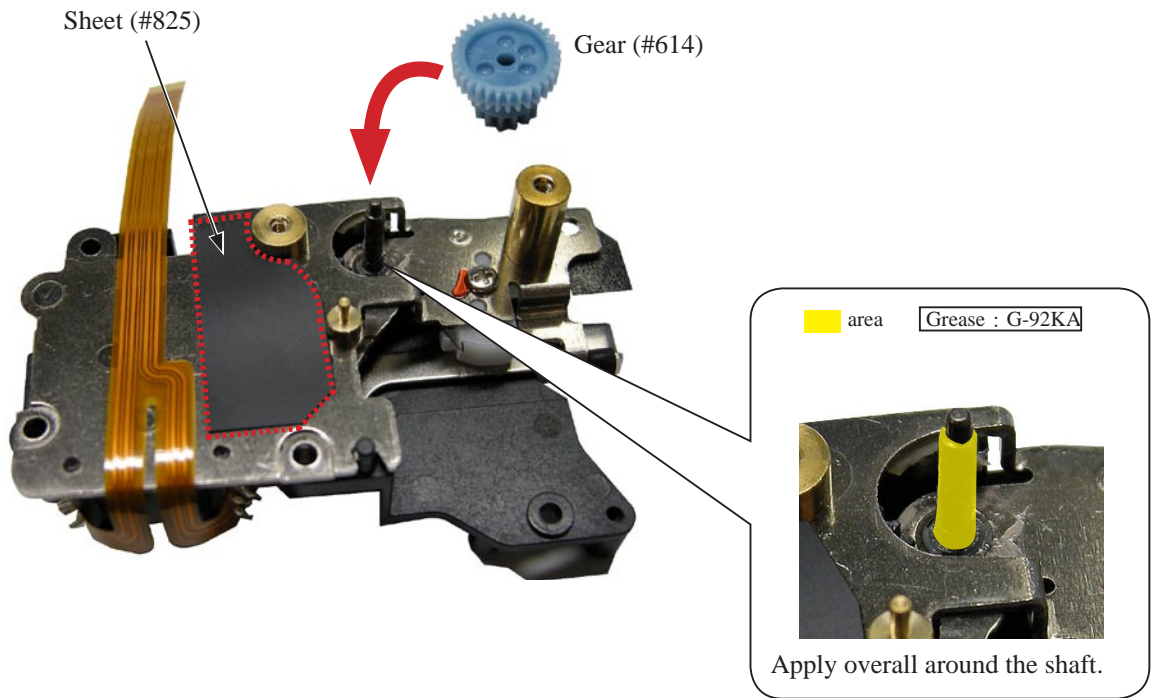

- Mount the charge motor unit (#B602).
- Tighten the two screws (#606).

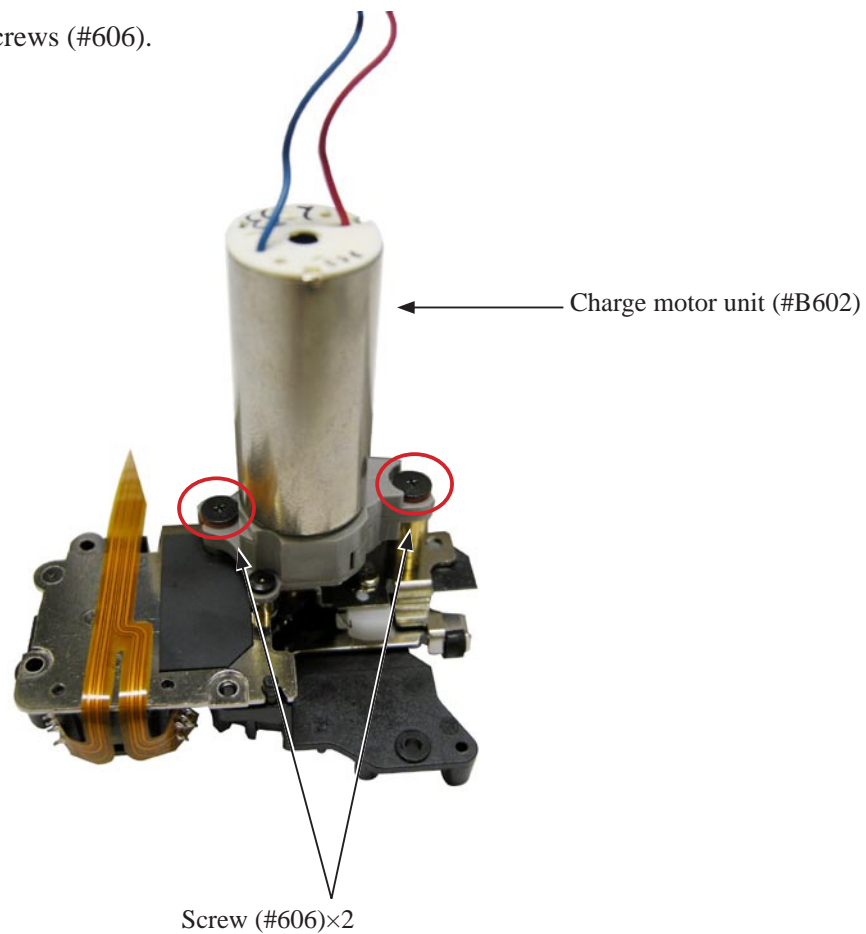

- Mount the charge base plate unit (#B620RP).

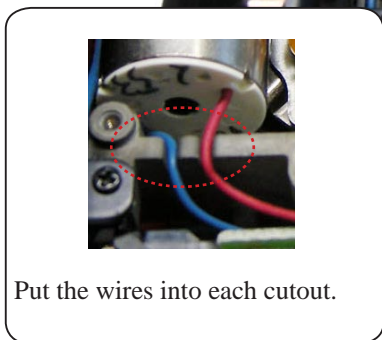
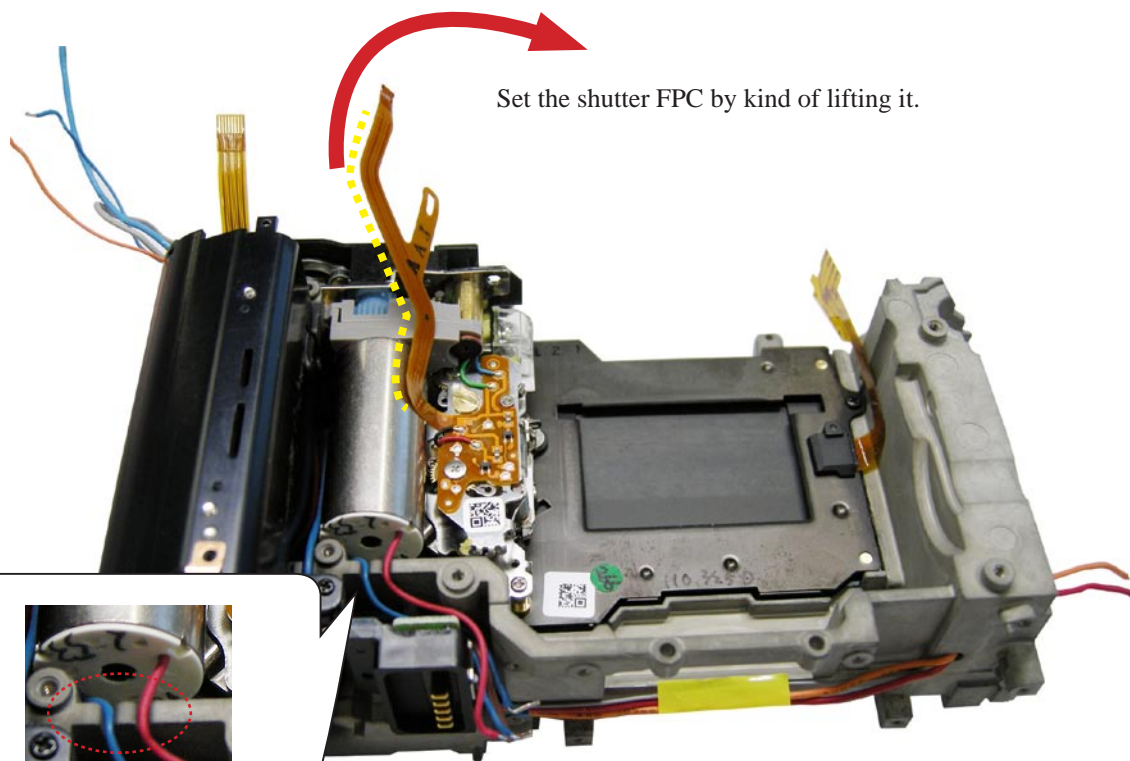
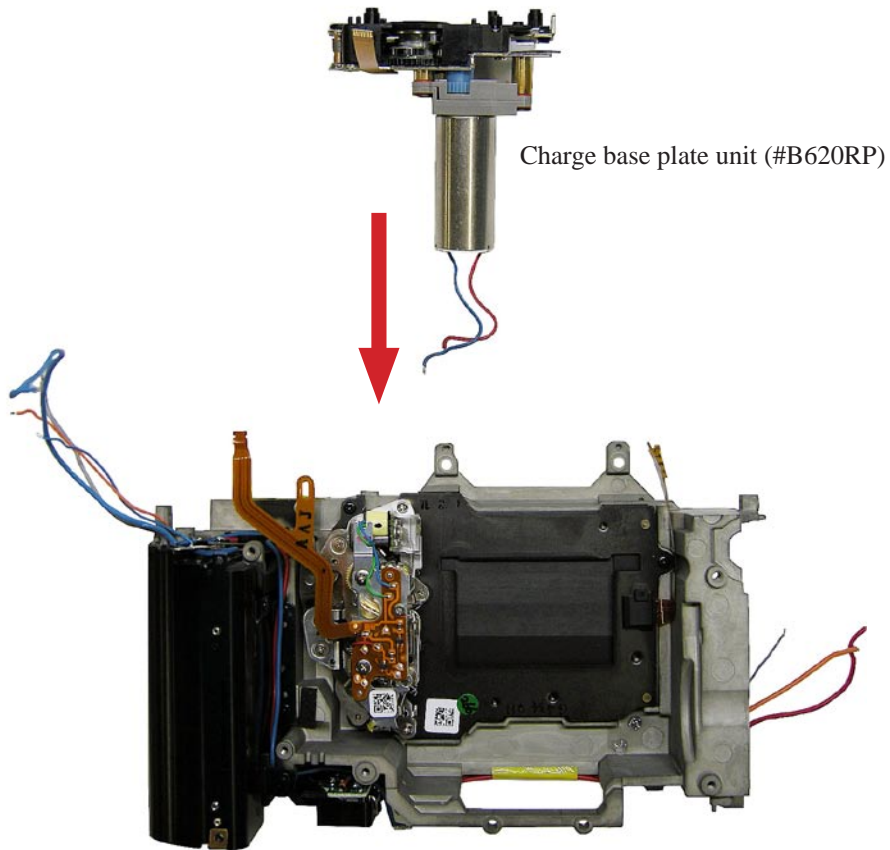

- Tighten the four screws (#1573).
- Attach the Sponge (#710).

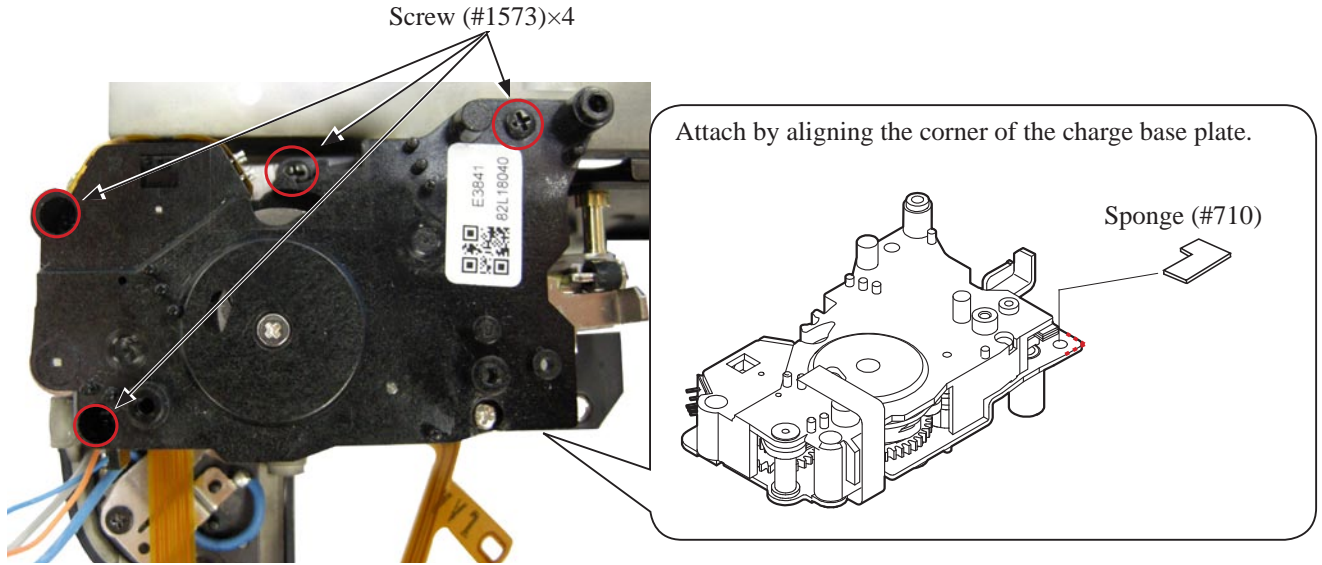

- Arrange the wires as below.

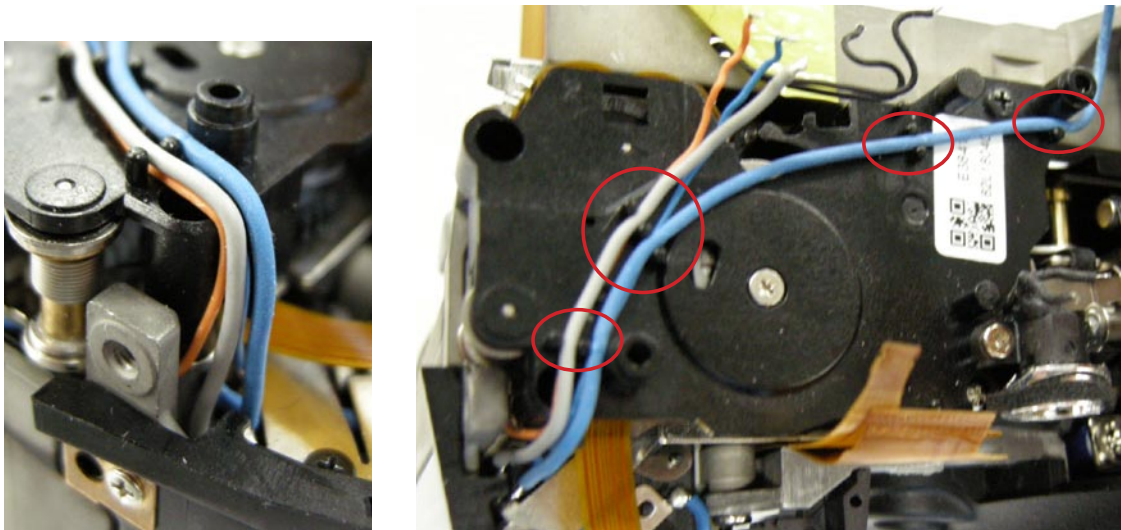

Arrange between bosses.

Piezoelectric buzzer

- Attach the Buzzer (#5065).

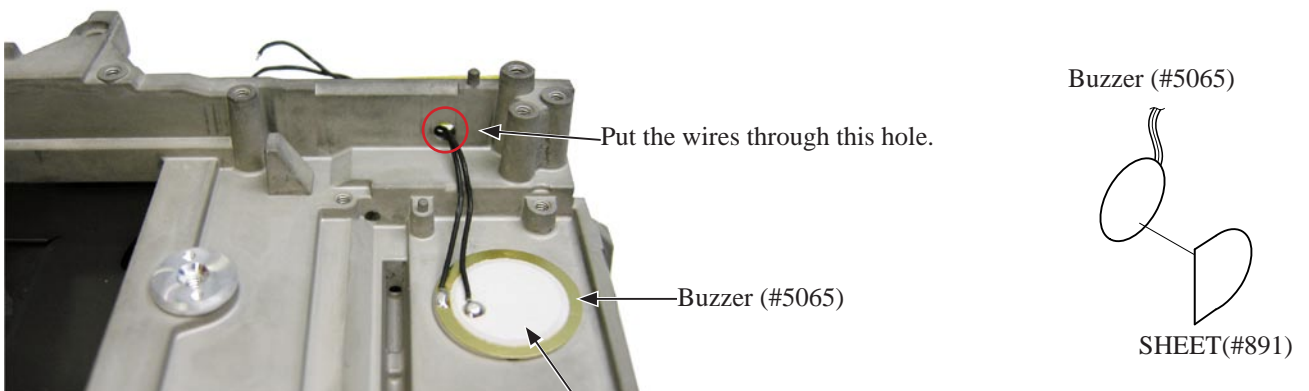

Do NOT press hard on this white area.

- Attach the tape [#TA-0005 (10×20)], and arrange the wires of the piezoelectric buzzer (#5065).

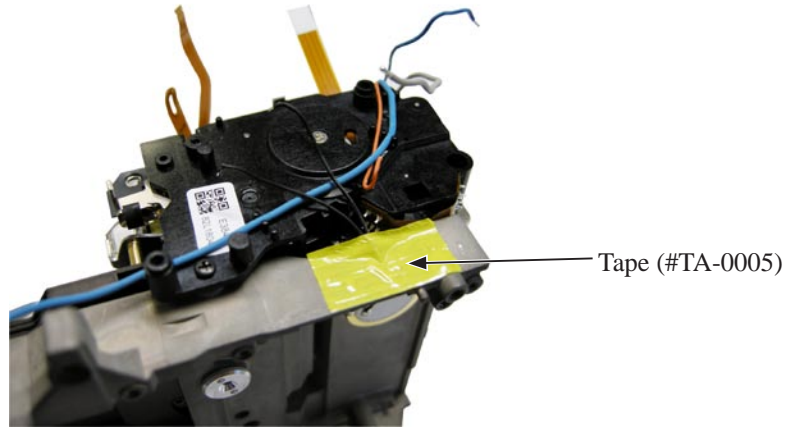

IF PCB

- Mount the IF PCB (#5019).
- Tighten the two screws (#1510).

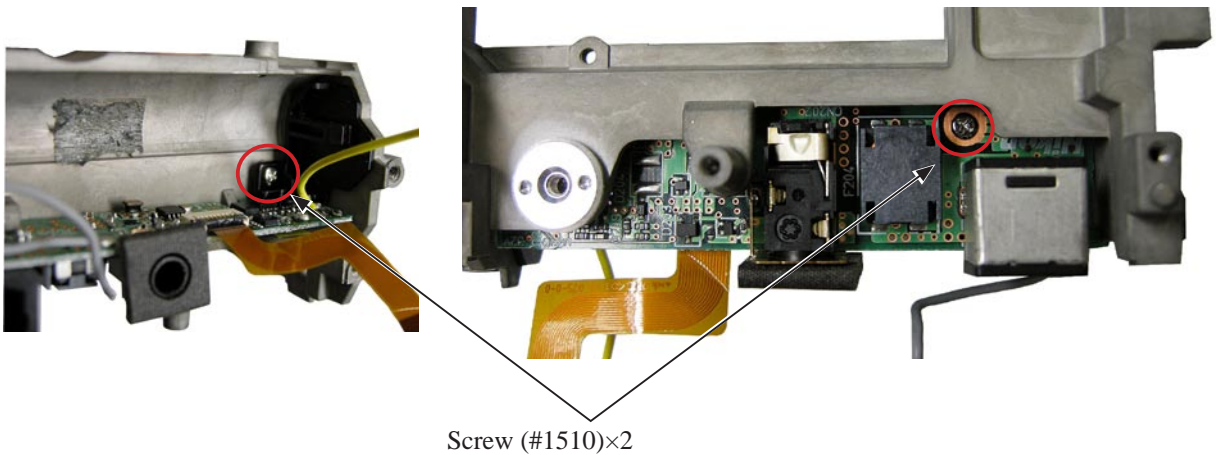
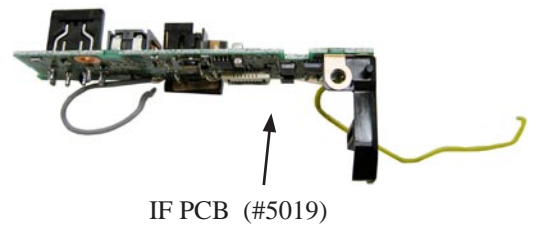
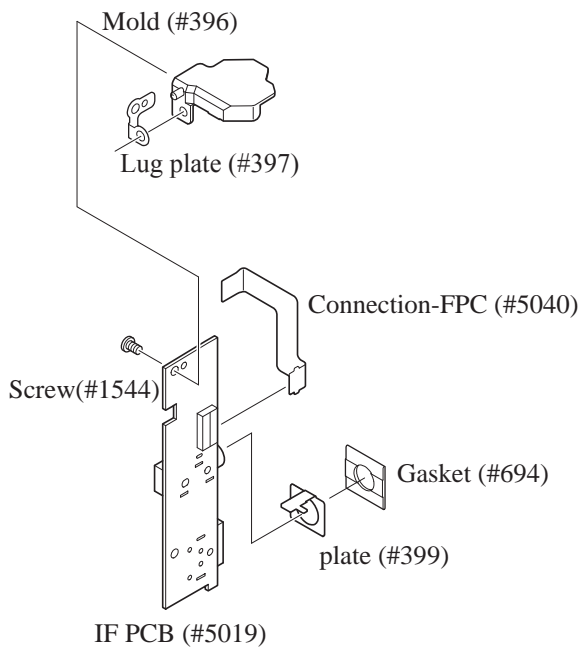

2. Front body unit

Mirror box

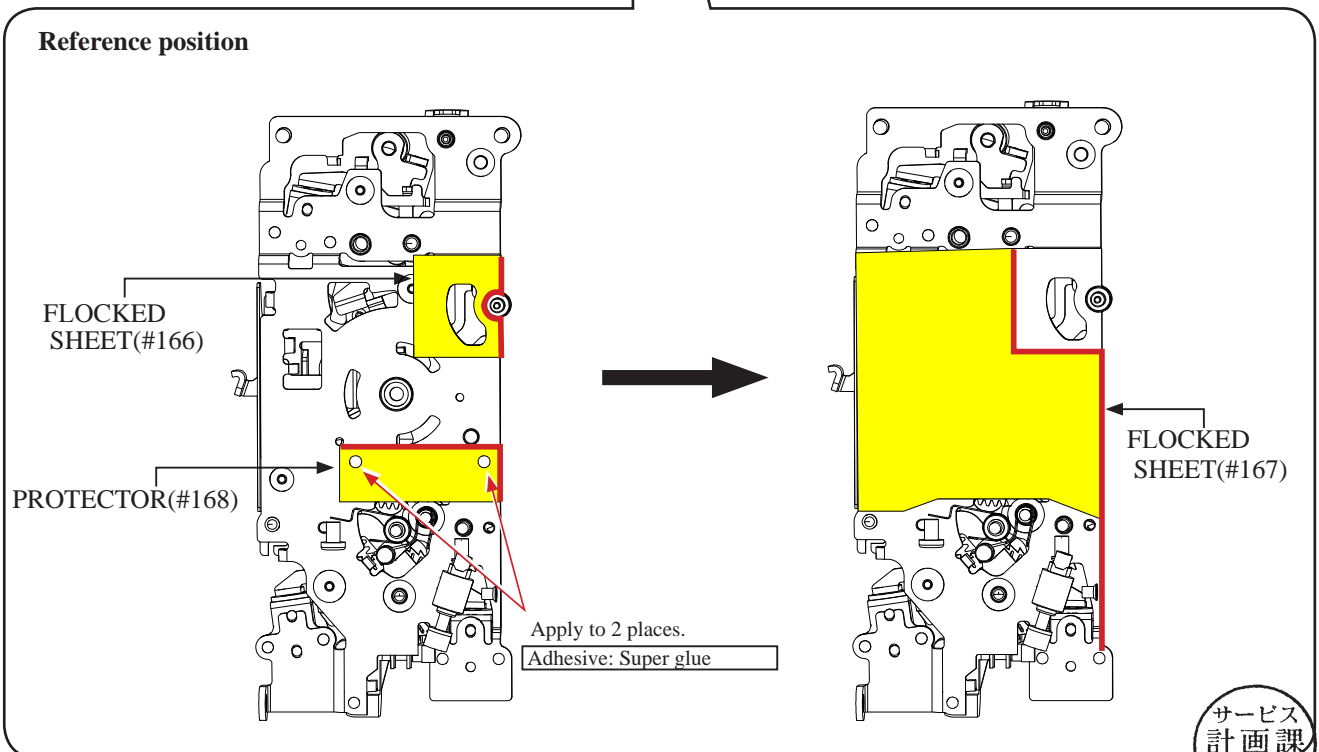
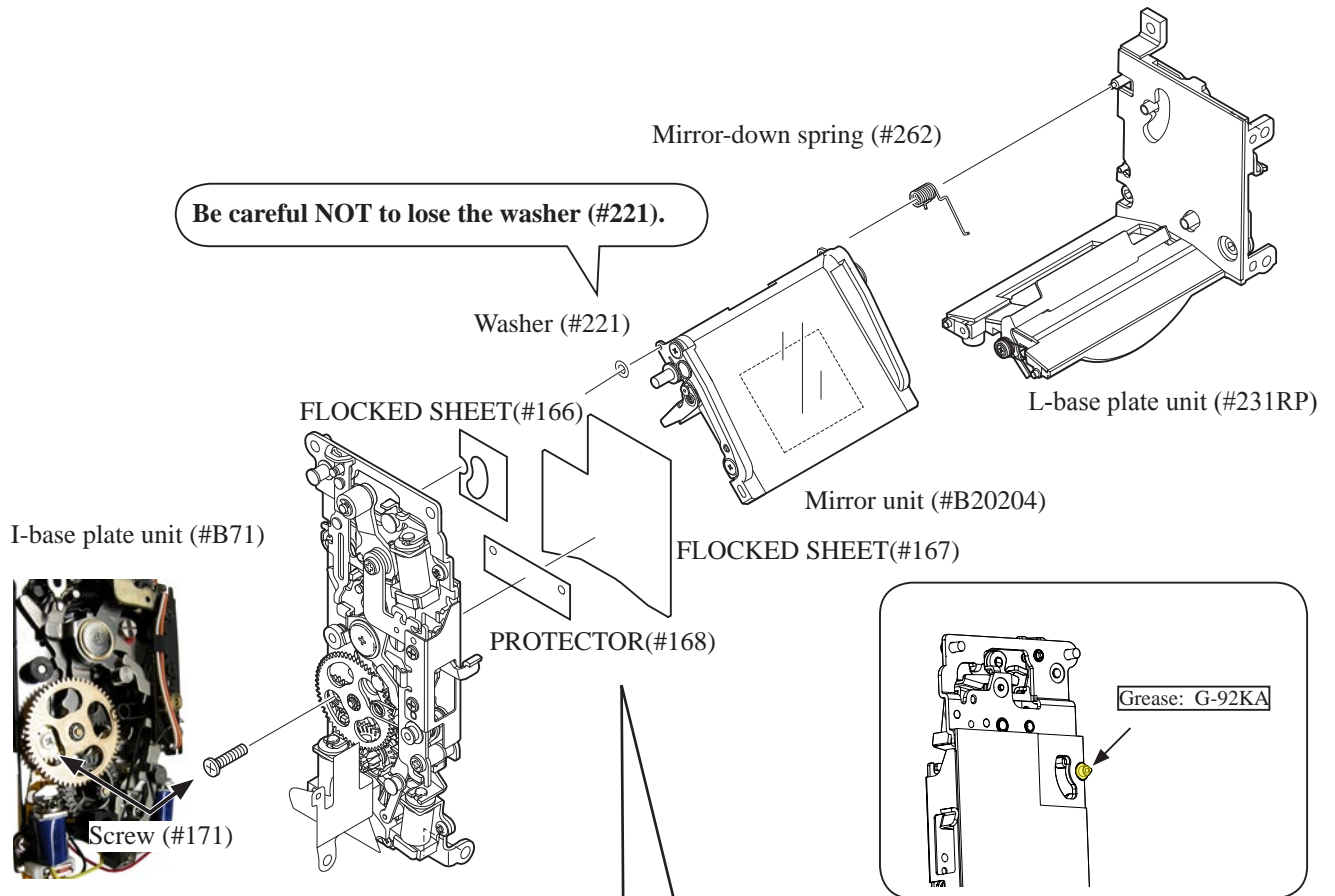

- Hook the mirror-down spring (#262) to the mirror unit (#B20204).

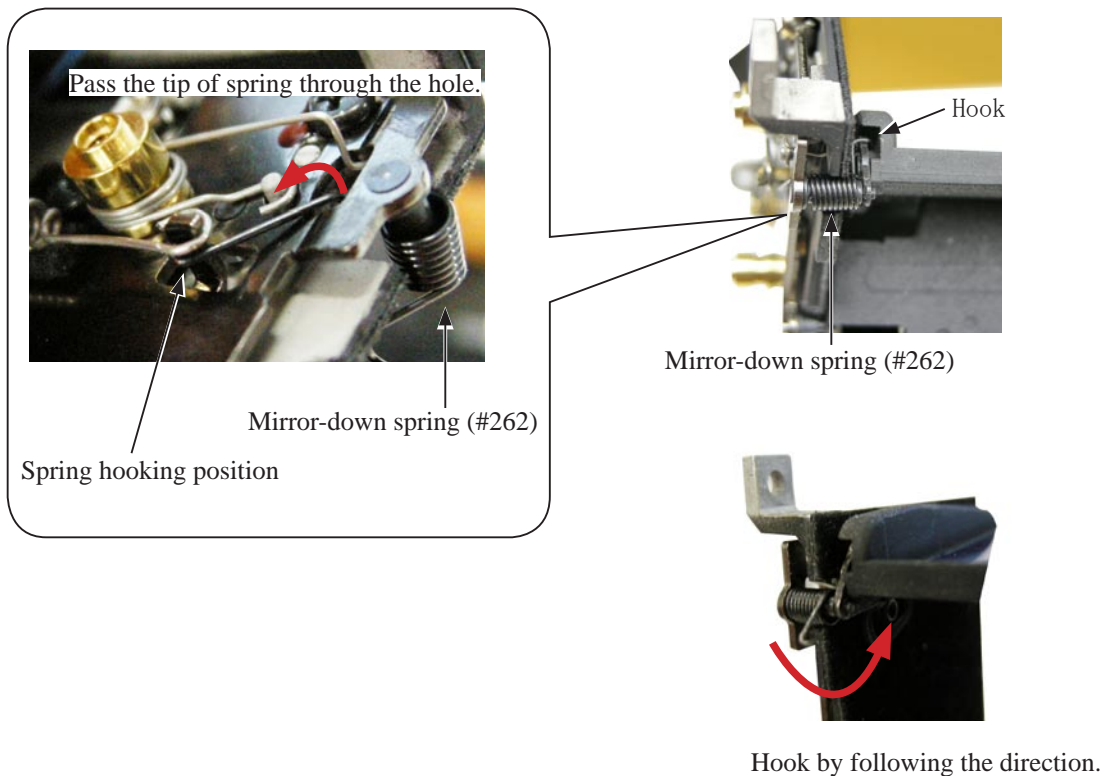

Front body accessories

(#907) Sponge

(#908) Sponge

(#909) Sponge

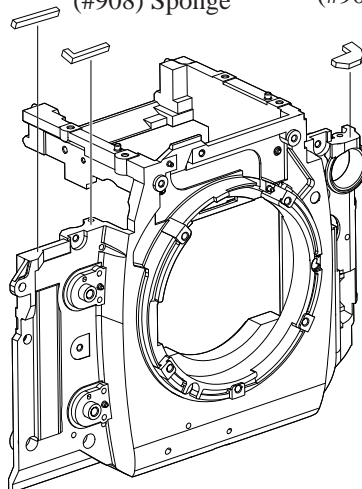

Apply to #907, #908, and #909.

Oil barrier: OS-30MEL

Lens contact

- Attach the F-F0 base plate unit (#B5024) and lens contact FPC unit (#B5008).
- Tighten the screw (#1615).

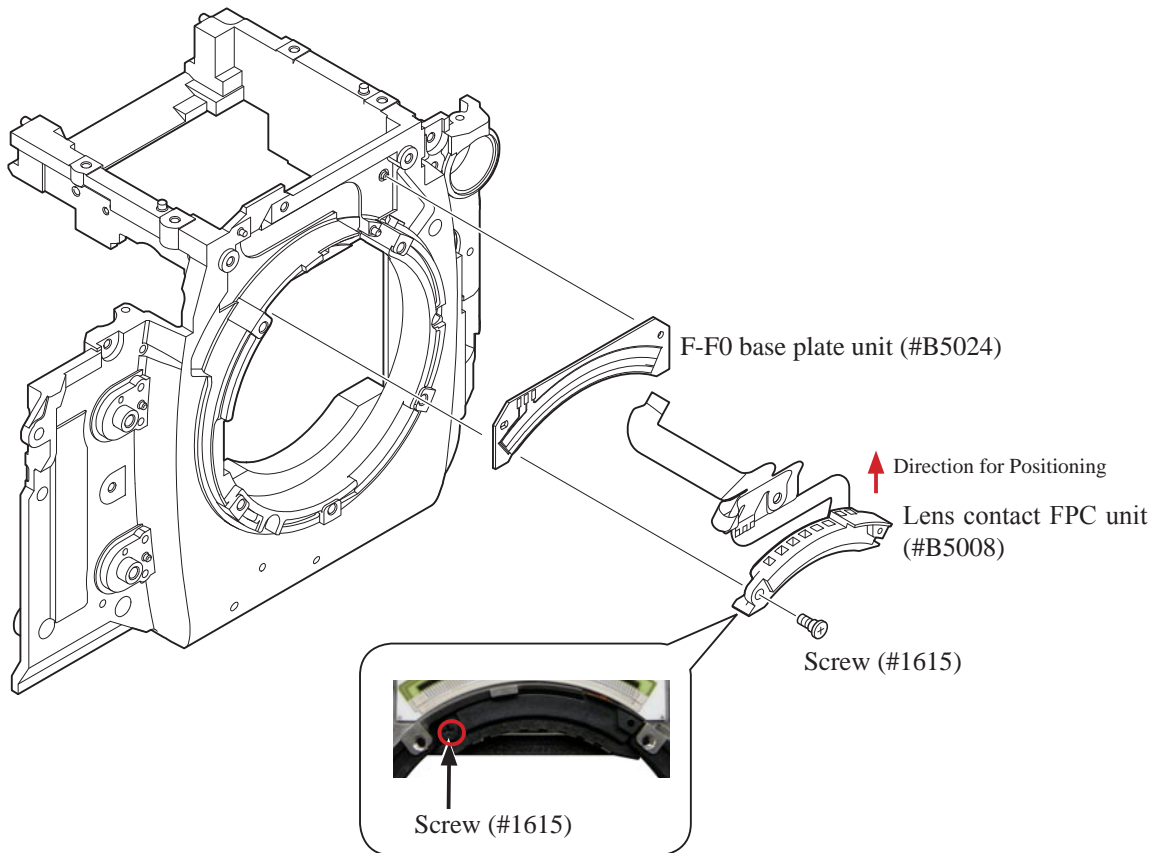

- Tighten the screw (#1521).
- Solder to joint the lens contact FPC unit (#B5008) and F-F0 base plate unit (#B5024).

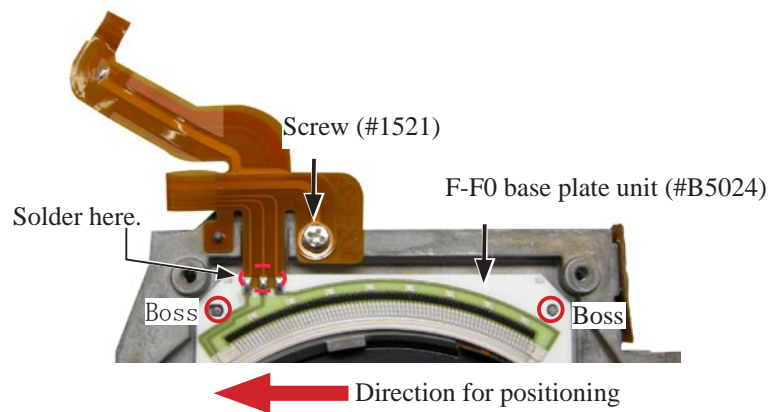

- Attach the sponge (#206) to the front body (#B26RP) along the shape of the concave portion.

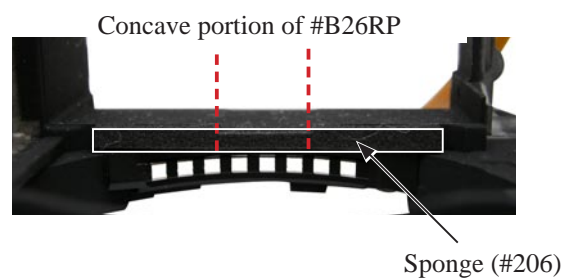

Function button

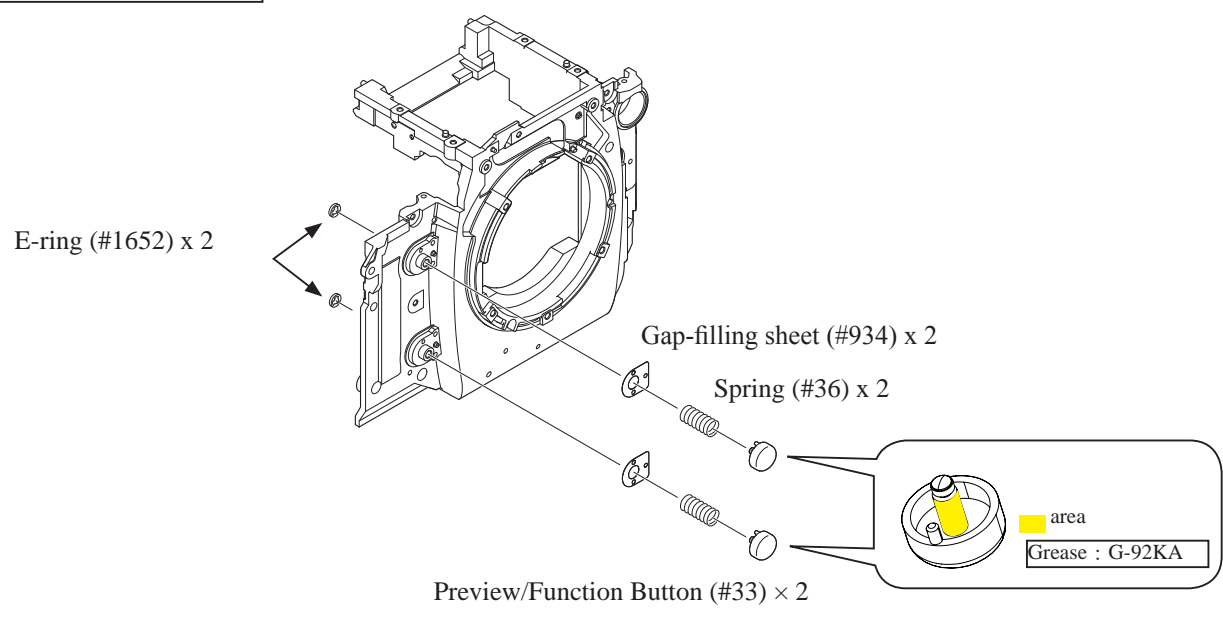

- Insert the backing plates (#35) between the front body FPC unit (#B5009).
- Tighten the four screws (#1510).

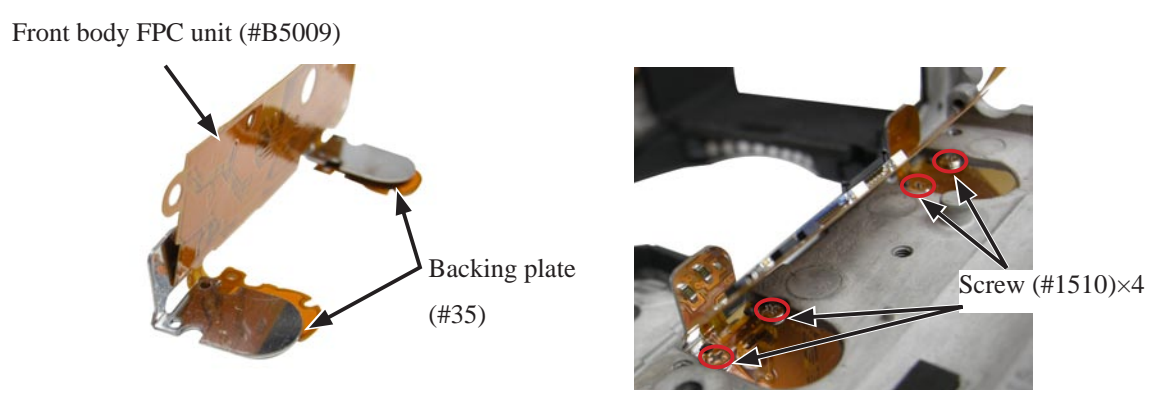

- Mount the front body FPC unit (#B5009) by fitting with the bosses.
- Tighten the screw (#1503).
- Attach the sponge (#608) by fitting the shape of the concave portion of the front body (#B26RP).

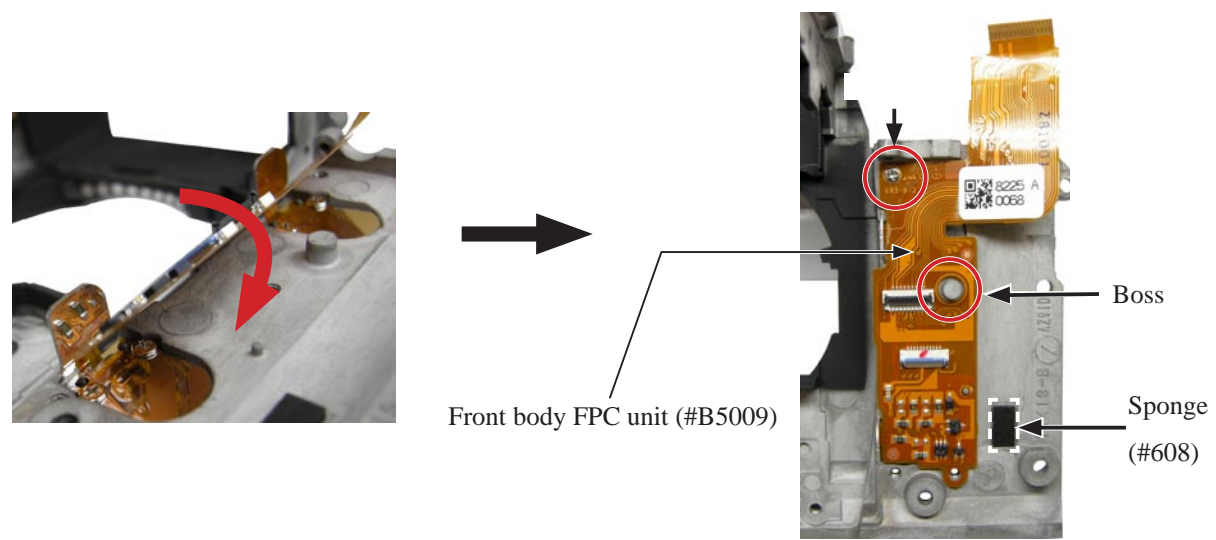

AF driving base unit

- Mount the AF driving base unit (#B10328).
- Tighten the two screws (#347).

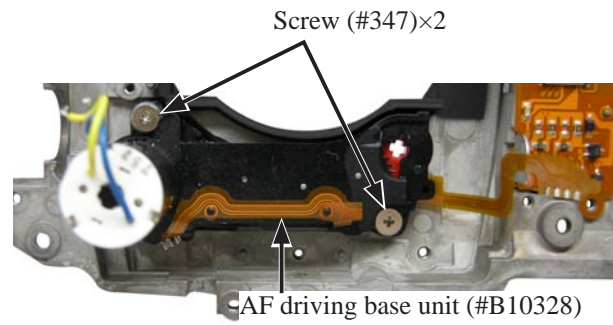

- Insert the coupling shaft (#342) into the hole by fitting its shape.

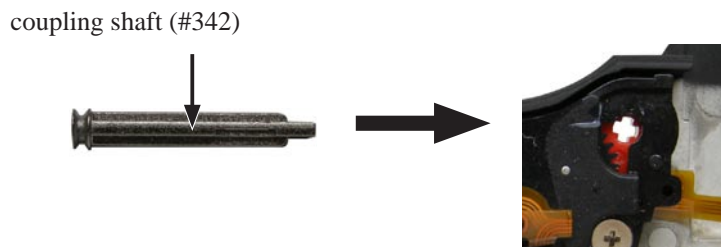

- Mount the side lever unit (#B355).

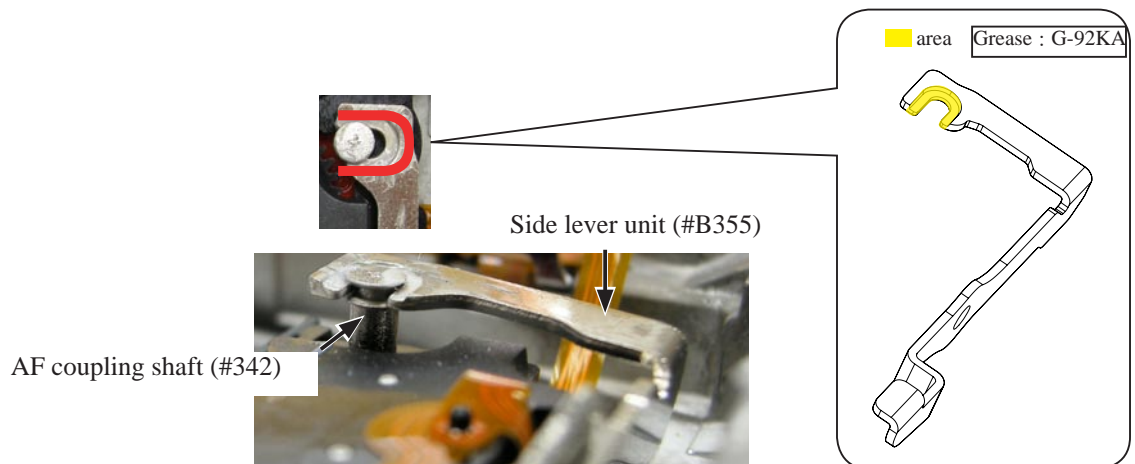

- Tighten the screw (#1513).

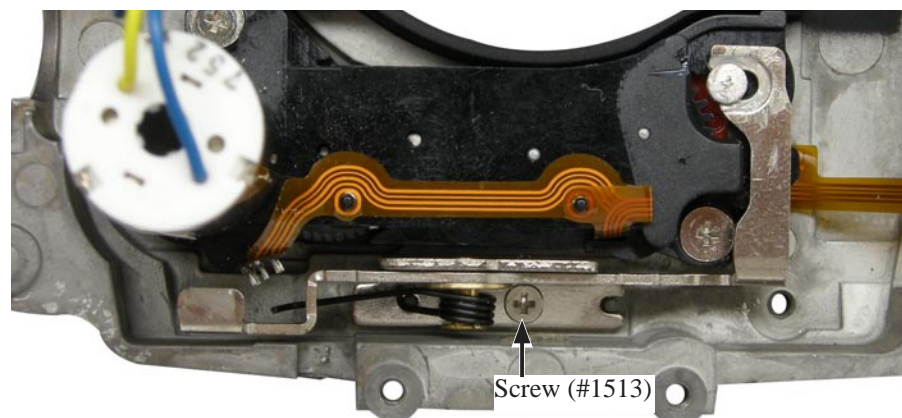

10-pin FPC

- Solder the 10-pin FPC (#5010).

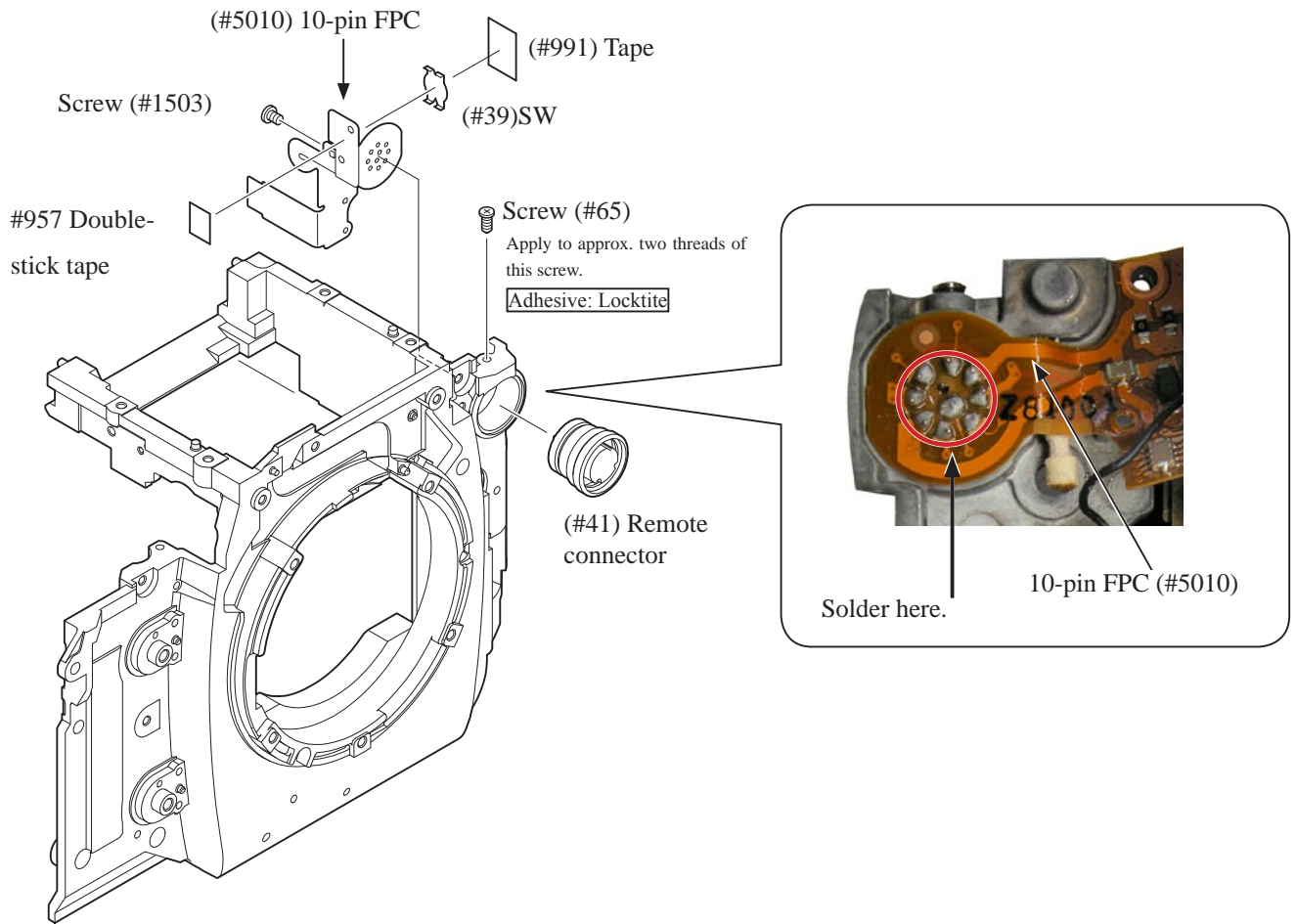

Mounting of Mirror box on Front body

- Mount the mirror box unit on the front body (#B26RP).

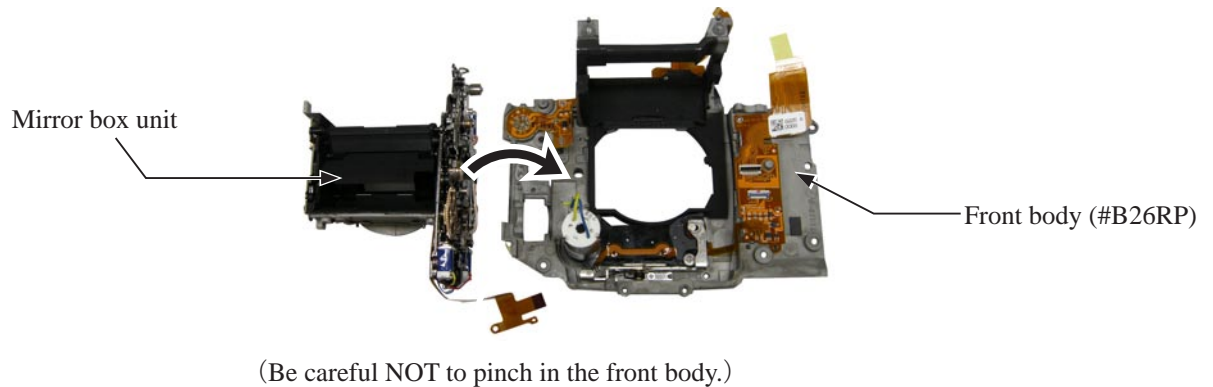

- Tighten the two screws (#1523), three screws (#1524), and the screw (#1530) in numeric order.

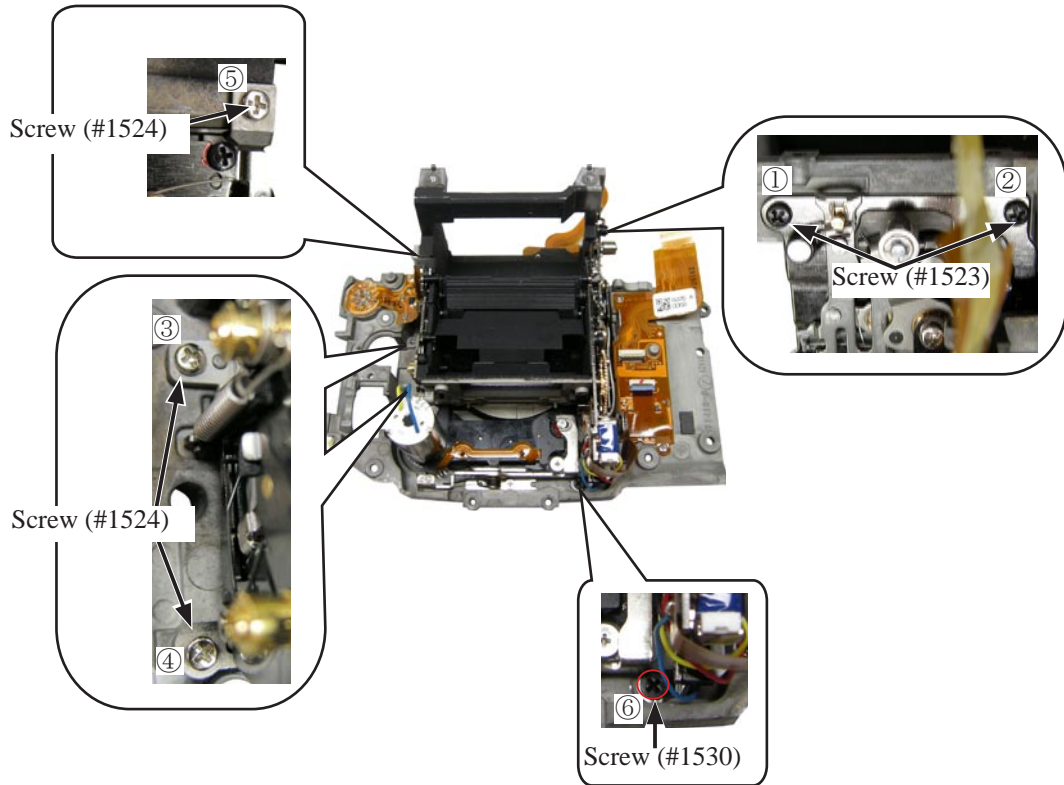

- Connect the FPC to the connector.
- Tighten the screw (#1503).

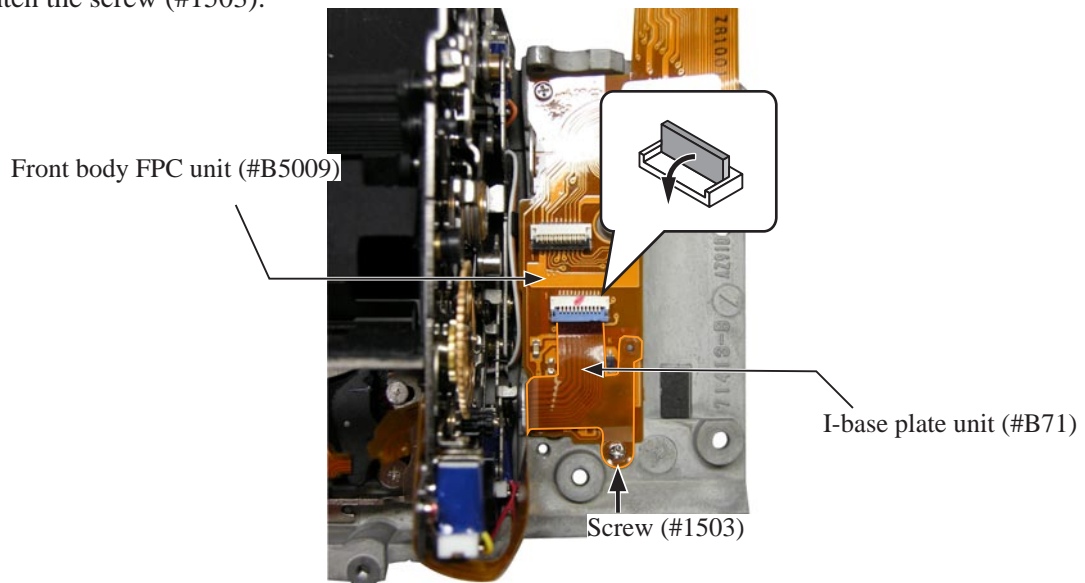

- Solder the FPC.

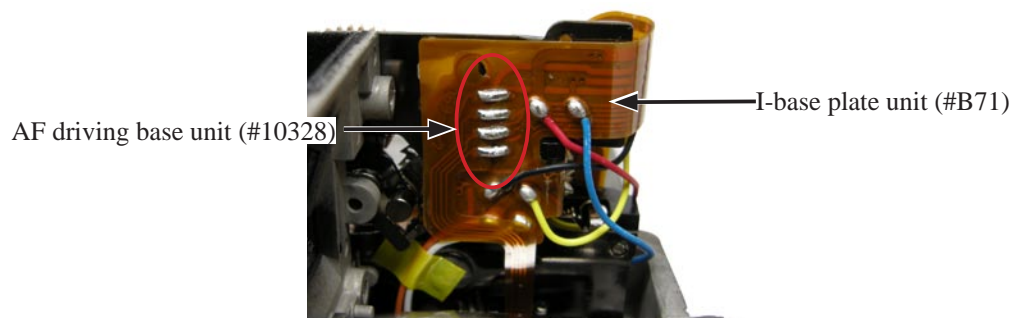

Release button

- Mount the release button unit (#B376) and attach the spring (#377).

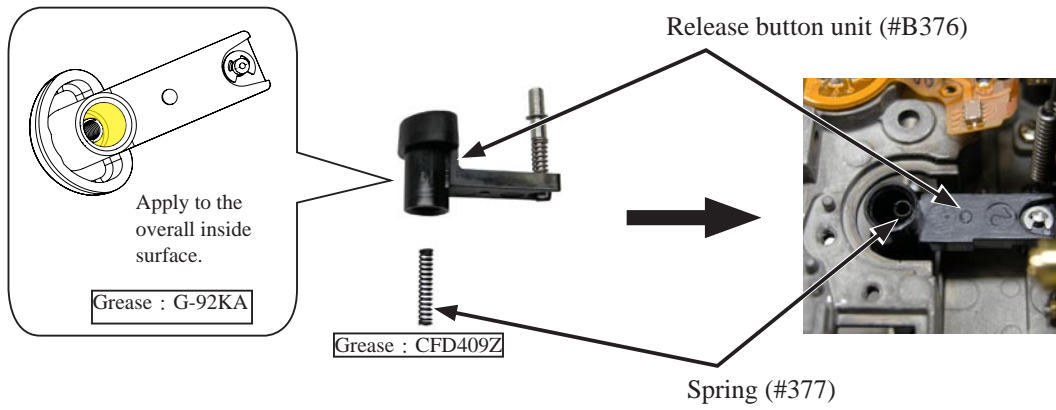

- Mount the release base unit (#B381).

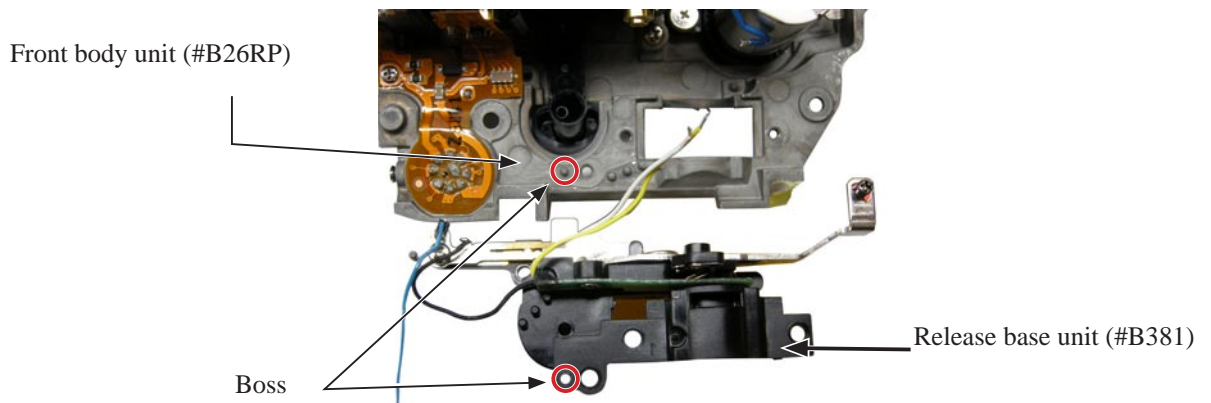

- When mounting the above, leave the black wire exposed short of the 10-pin FPC (#5010) as below.

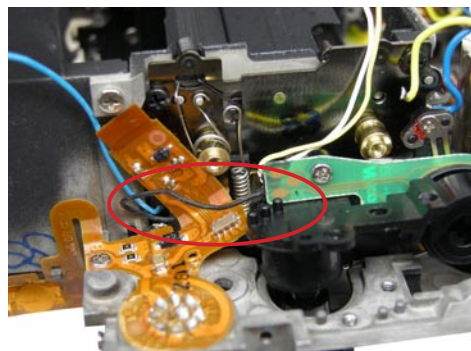

- Tighten the screw (#1516) and three screws (#66).

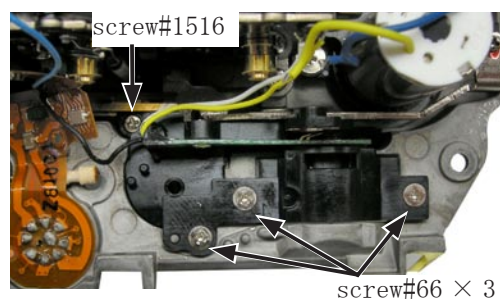

Front cover

- Attach SB pop-up button (#40) and synchro-mode button (#37).

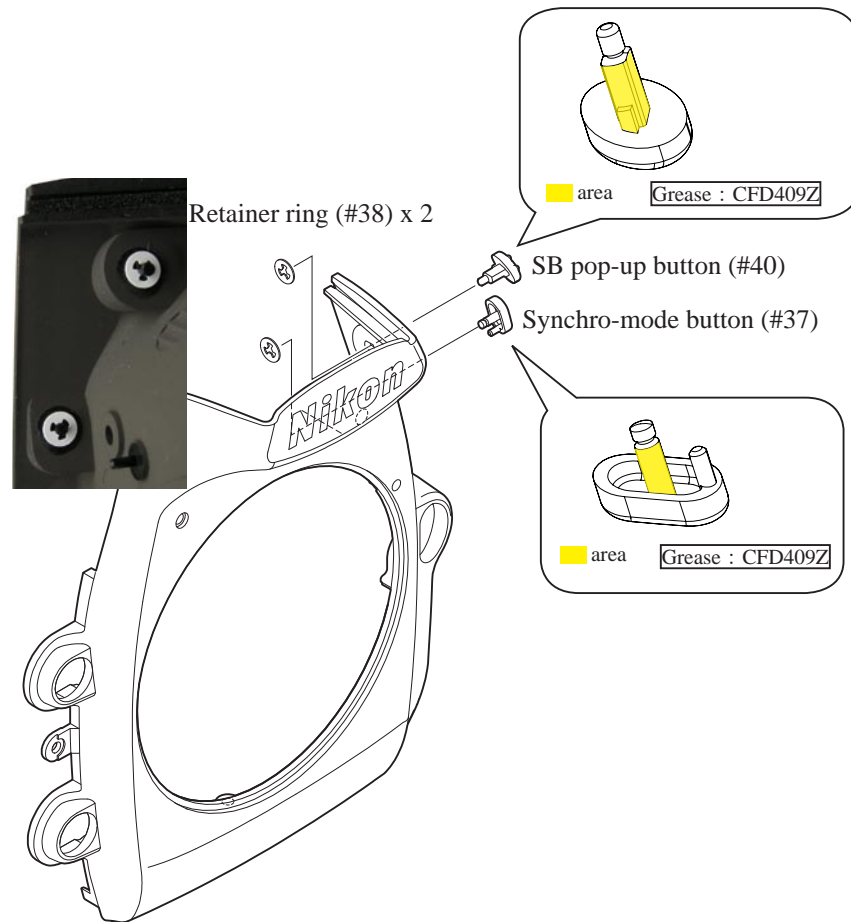

- Attach the drip-proof sponge (#992) by aligning the reference line.

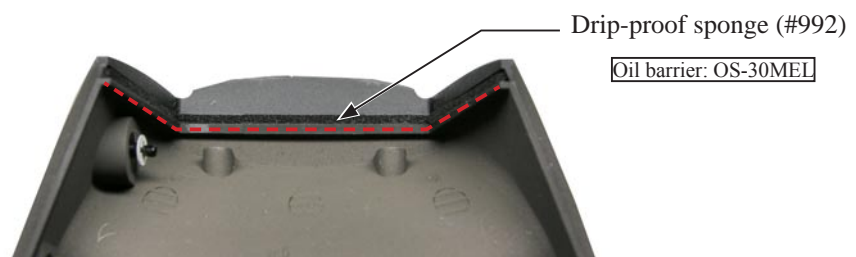

- Attach the drip-proof sponge (#916-1).
- Mount the aperture coupling ring unit (#B404RP).

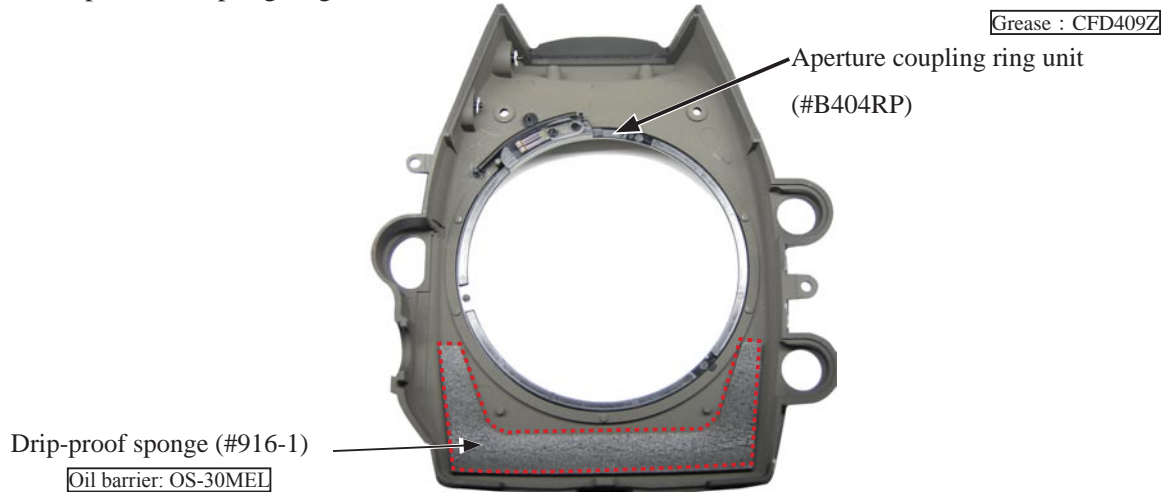

- Put the roller (#407) on the shaft, and hook the spring (#406) to the boss and roller as below.

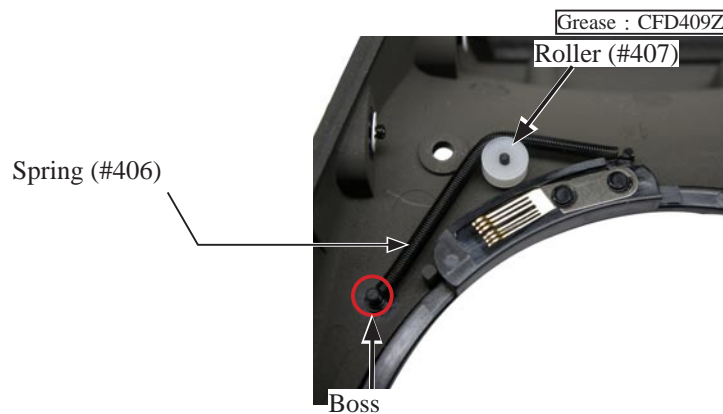

Mounting of Front cover on Front body

- Mount the apron (#B22) on the front body unit (#B26RP).

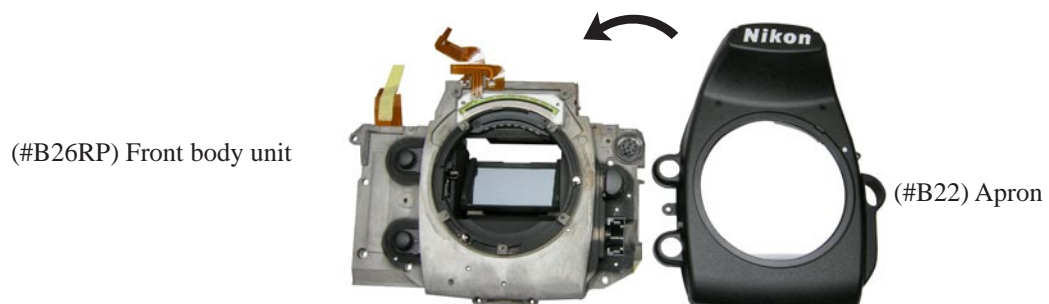

- Tighten the two screws (#1518) and three screws (#55).

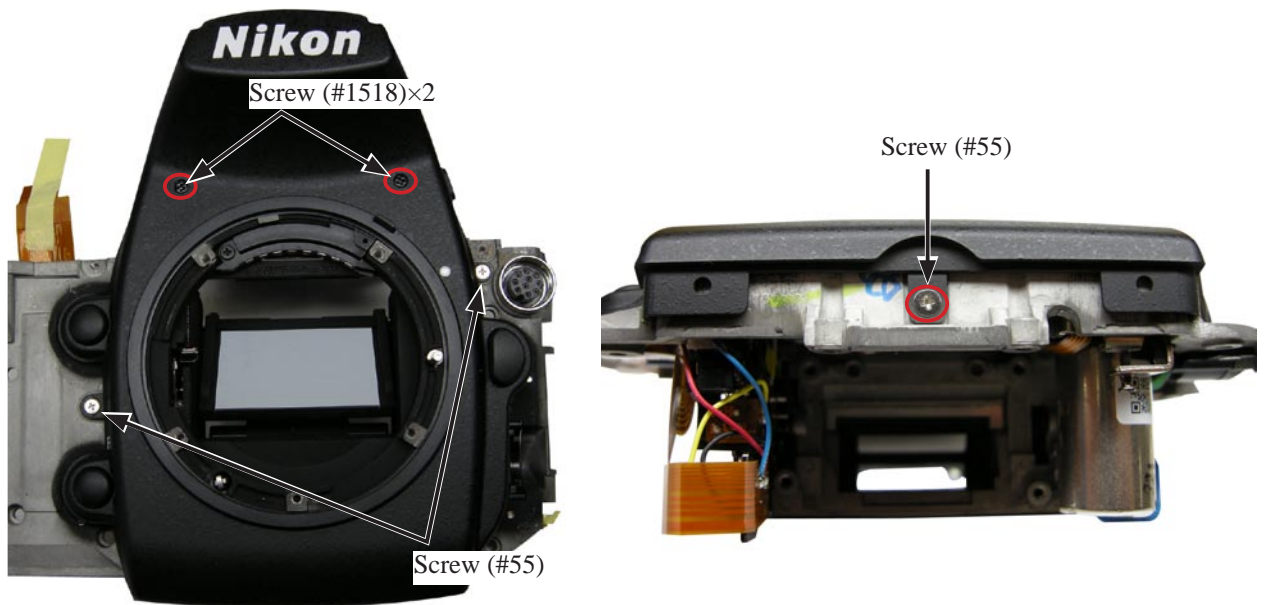

- Mount the SCM changeover lever (#383), and tighten the screw (#387).
- Mount the cover ring (#388).

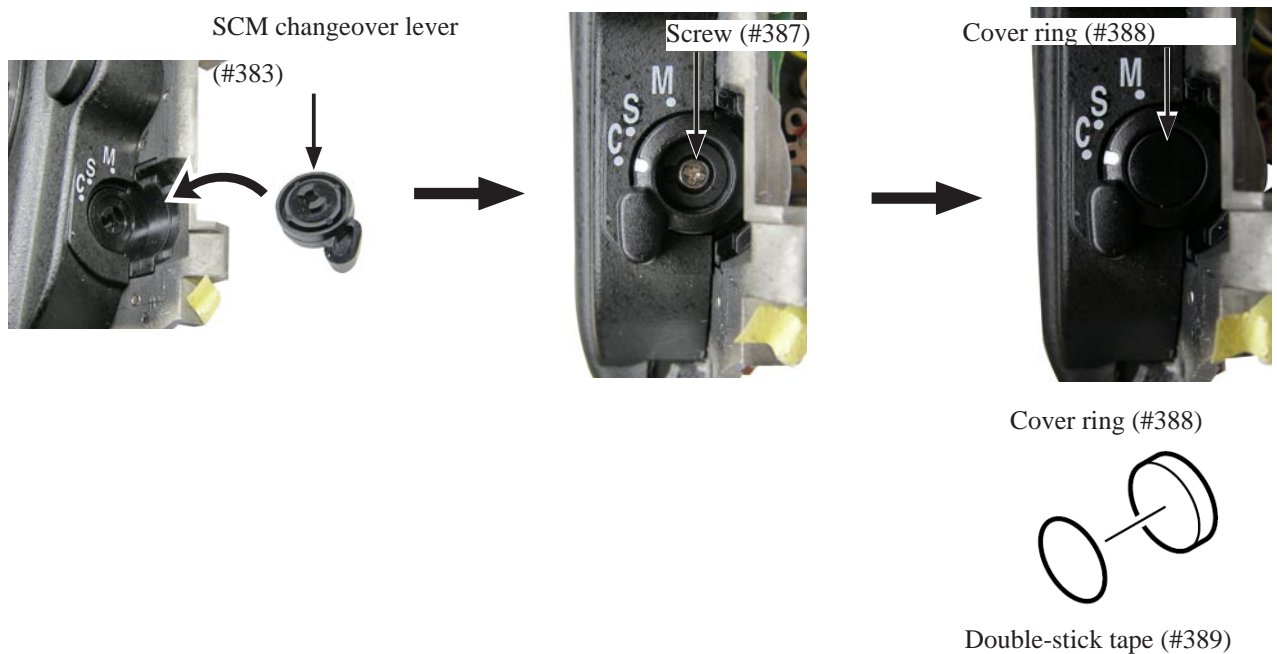

Bayonet

- Mount the bayonet mount spring (#402).

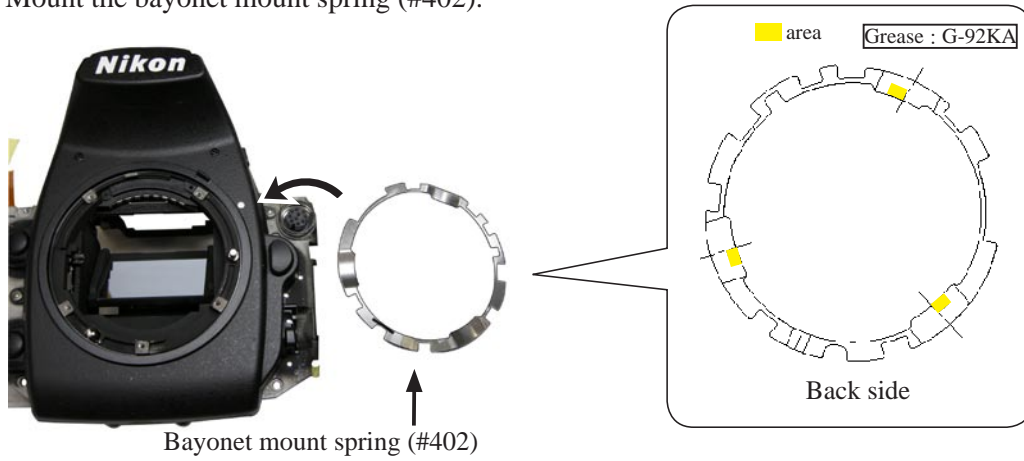

- Attach the flocked sheet (#906).

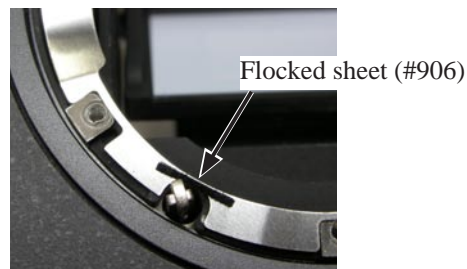

- Mount the bayonet mount (#401).

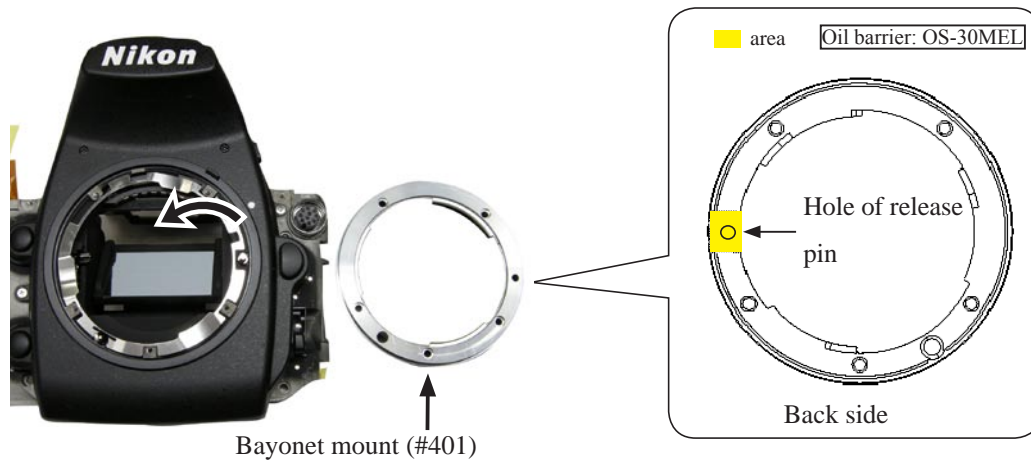

- Tighten the screw (#1620).
- Tighten the four screws (#1621) in numeric order.

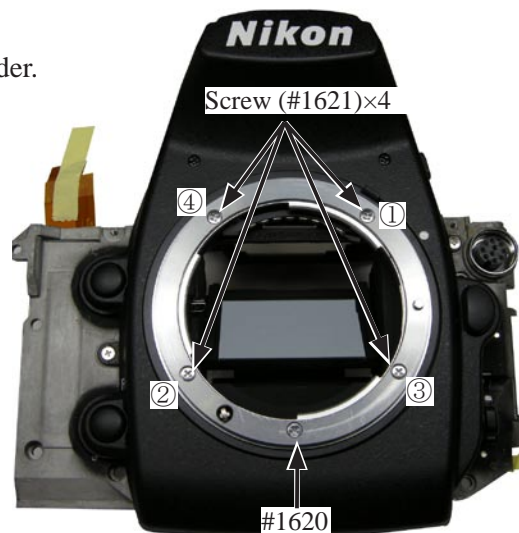

Height adjustment of AF coupling shaft

- Set the position of the focus mode selector dial to "C".
- Adjust the height of the AF coupling shaft (#342) to "1.7±0.15 mm" with the screw (#359).
- ※ When the focus mode is set to "S", the shaft must not move.
- ※ When the focus mode is set to "M", the shaft must NOT protrude from the bayonet surface.
- ※ When the release button is fully pressed, the shaft must NOT protrude from the bayonet surface.
- Fix the screw (#359) with the adhesive.

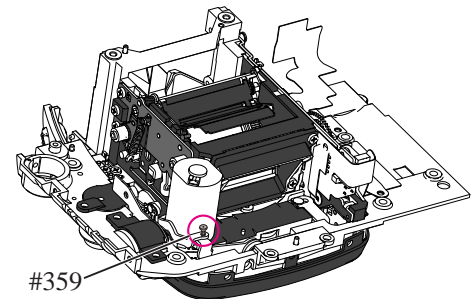
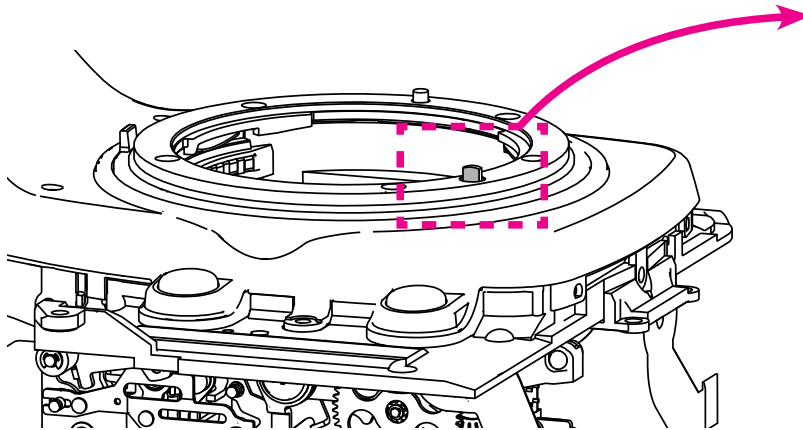
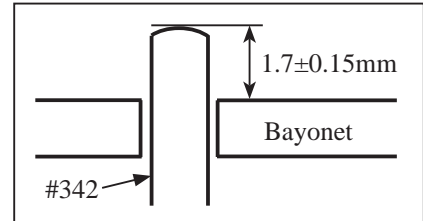

Adhesive: Screwlock

Height adjustment of Aperture lever

- Measure the height of the aperture lever with the tool (J18004).
Standard: 3.35 - 3.45mm
- **Be careful NOT to bend the lever.**
- In case of nonstandard, make the adjustment by using the adjustment screw.

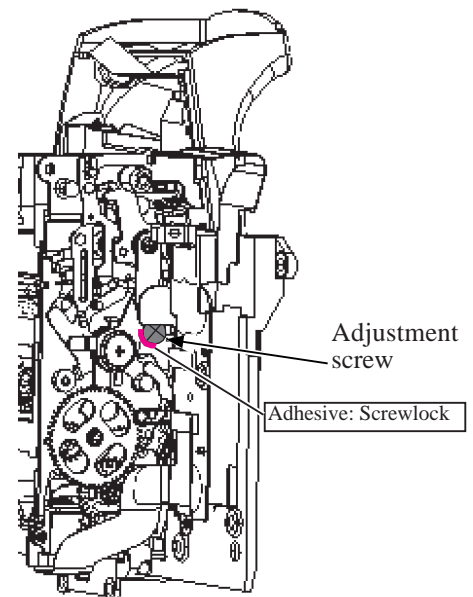
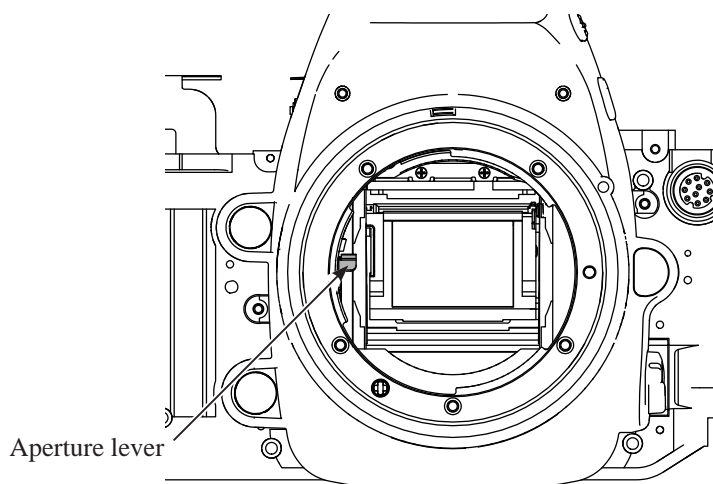

Tool



AF sensor

- Mount the AF sensor base plate (#B10277).
- Tighten the three screws (#1509) in numeric order.

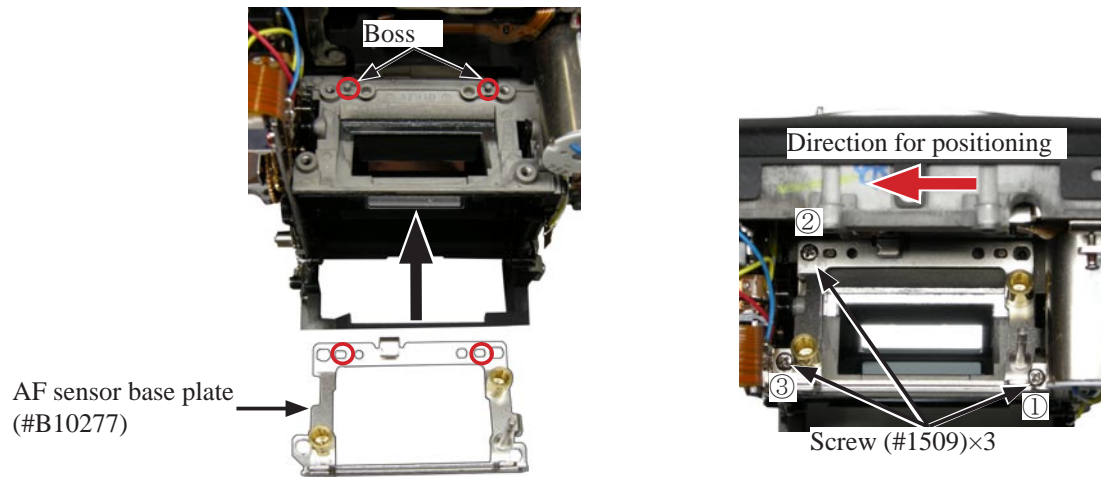

- Tighten the screw (#283).
- Attach the Spring (#284).

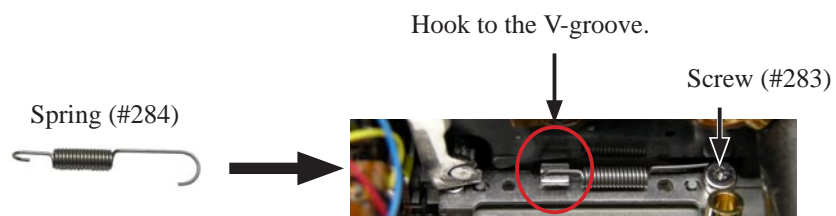

- Tighten the screw (#65).

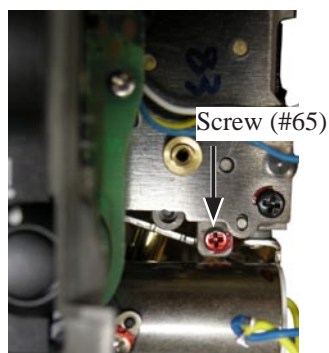

- Attach the spring (#273) and two springs (#276).

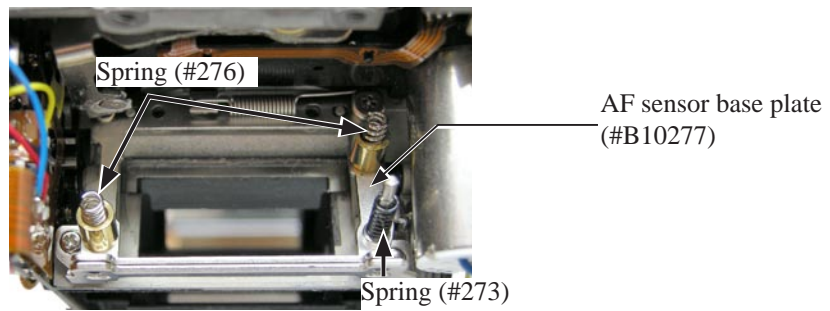

- Mount the AF sensor unit (#B20294) by fitting the support pole of the AF sensor base plate (#B10277).
- Put the two washers (#1657).
- Tighten the two screws (#275) lightly in numeric order from ① to ② until the screw point touches the ground, then make three turns counterclockwise.

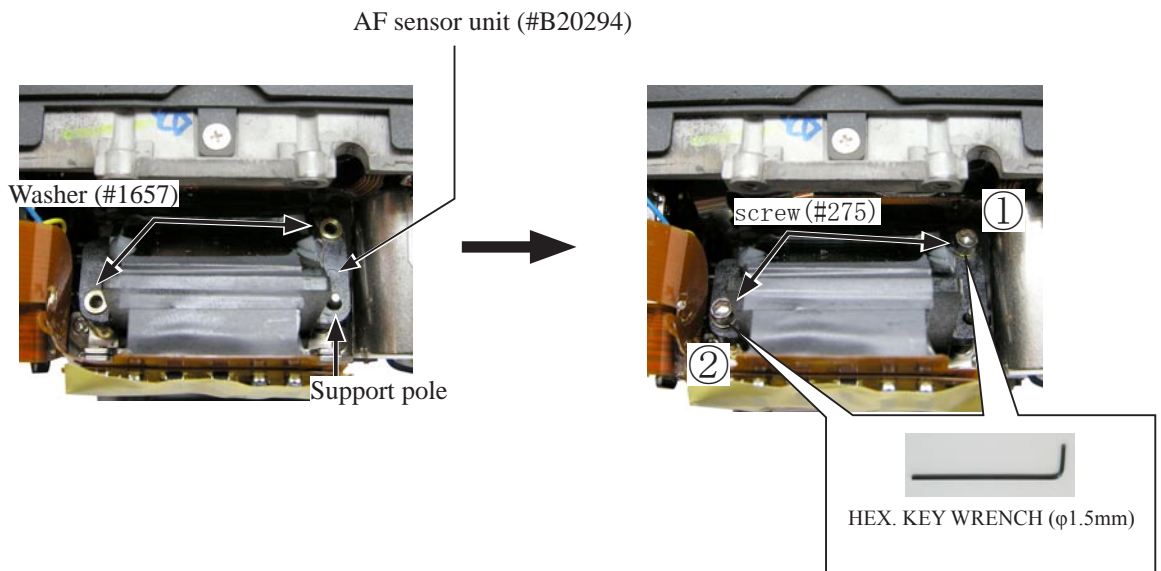

- Put the washer (#274) on the support pole of the AF sensor base plate (#B10277).
- Put the E-ring (#1653).

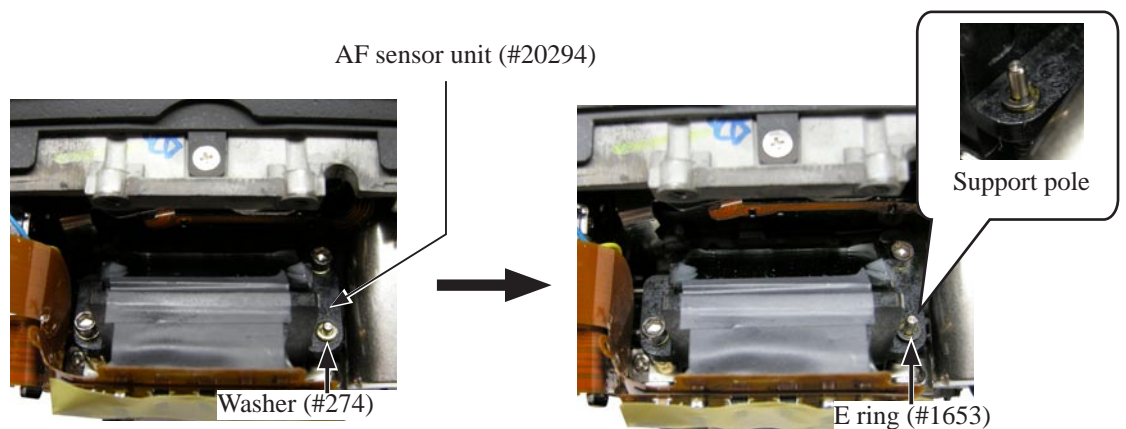

- Connect the FPC to the connector.
- Tighten the screw (#1503).

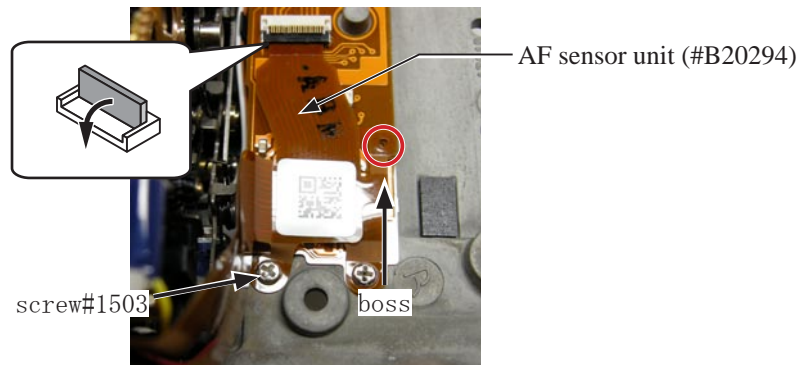

- Insert the the connection-FPC (#5042) under the AF motor, fitting with the boss.

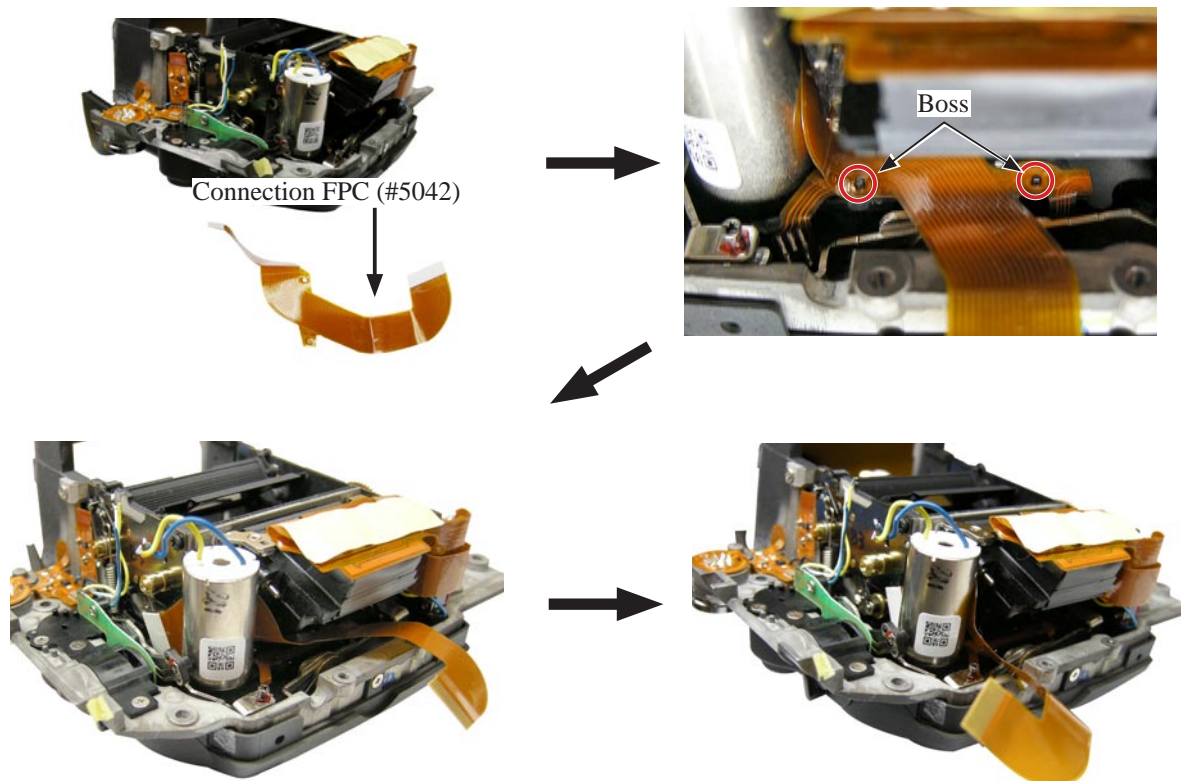

Power drive

- Tighten the two screws (#1663).
- Solder the wires ([Blue][White][Yellow]) and the wires ([Blue][Yellow]) of AF motor.
- Connect the FPC to the connector.

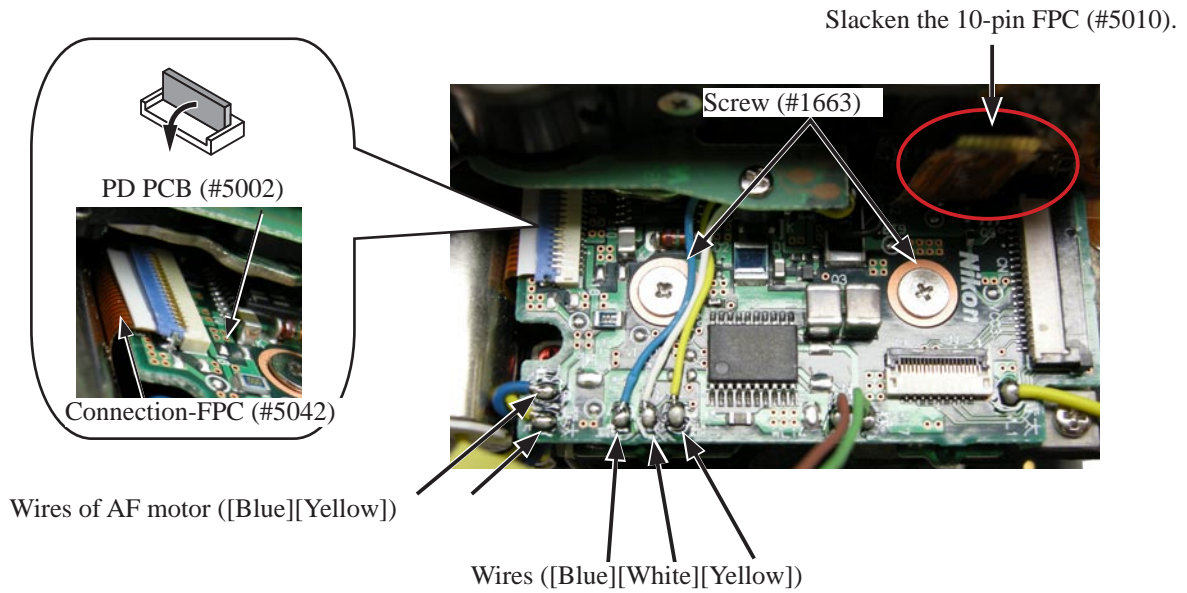

- Insert the 10-pin FPC (#5010) under the wires ([Blue][Black]), then connect it to the connector.

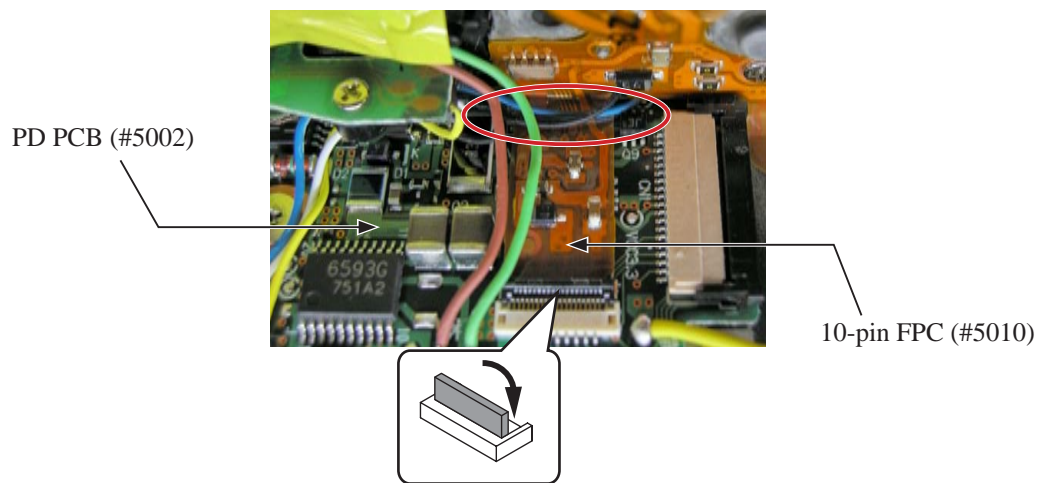

- Attach the tape [#TA-0005 (10×20)] to fix the wires ([Green][Brown]).
- Attach the connection-FPC (#5042) by fitting with the boss.

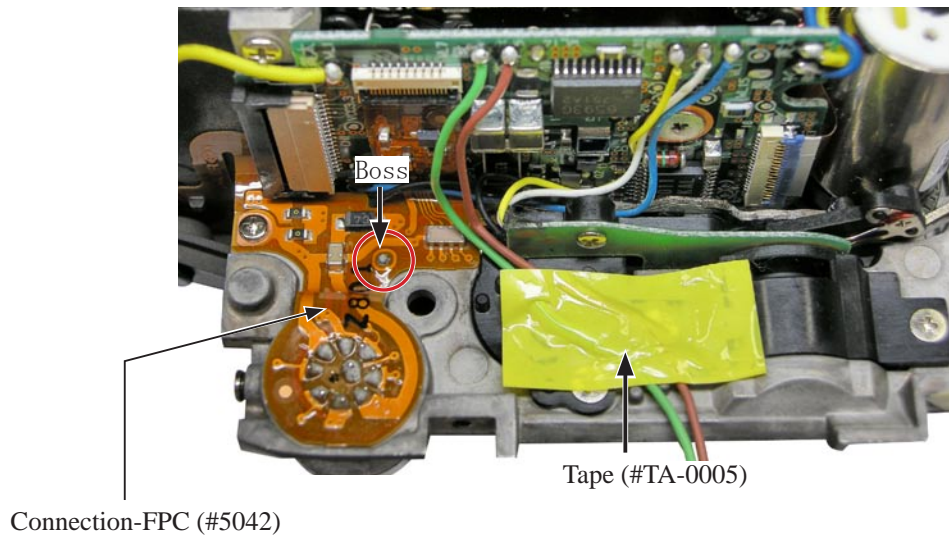

- Arrange the yellow wire of the PD PCB (#5002) as below.

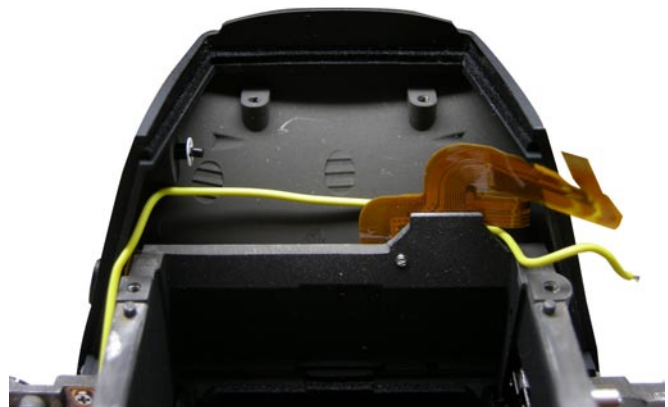

3. Prism box unit

SI unit

- Insert the SI-LCD unit (#B5055) all the way into the prism box (#B1101RP).

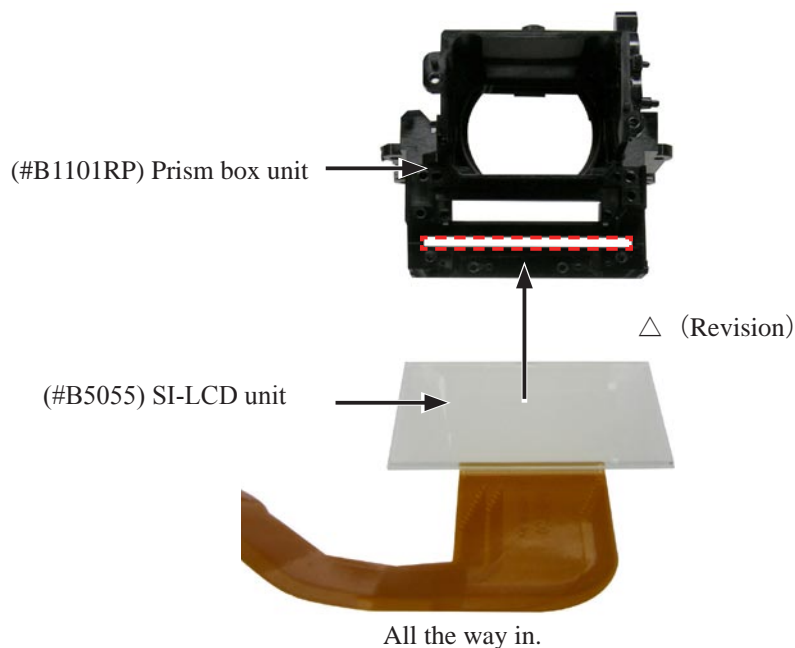

- Put the SI-LCD holding rubber #1115 (two types: A and B) into the gap between the prism box unit (#B1101RP) and the SI LCD unit (#B5055).

Be carefun NOT to damage the SI-LCD unit (#B5055) when putting the rubber.

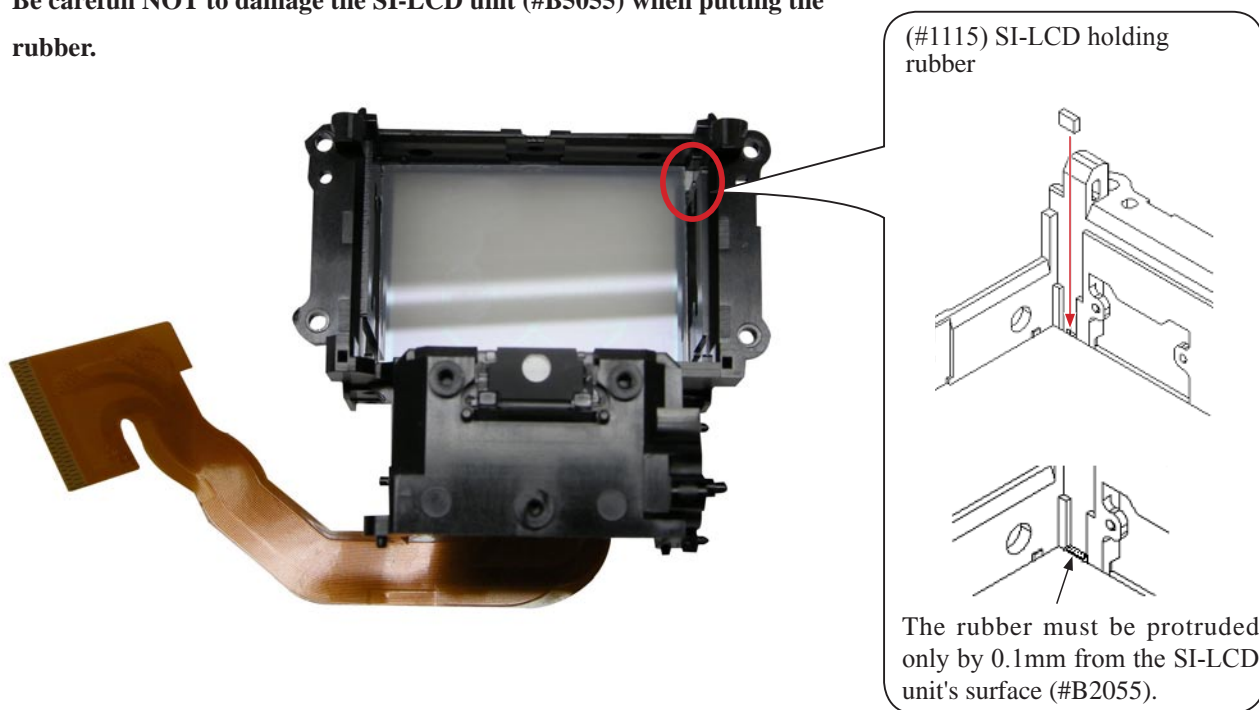

(#1115) SI-LCD holding rubber

A #1115A 1K105-430

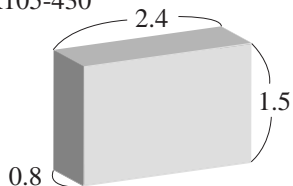

B #1115B 1K105-510

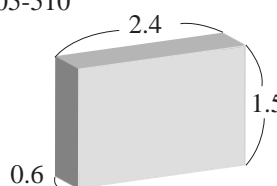

There are two types of rubber (A and B). If A type is too tight to be fit in, use B type.

- Put the SI-LCD holding rubber (B#1117) under the SI-LCD unit (#B5055).

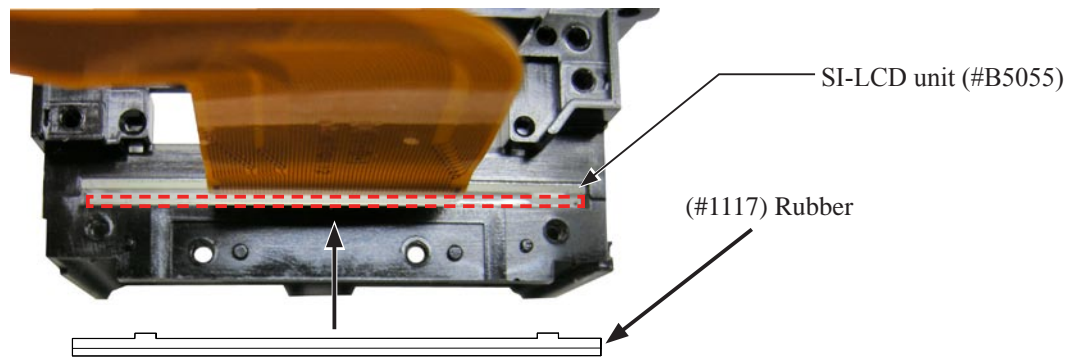

- Push the head of the plates [(#1163) and (#1164)] into each square hole of the prism box, fitting with the boss.

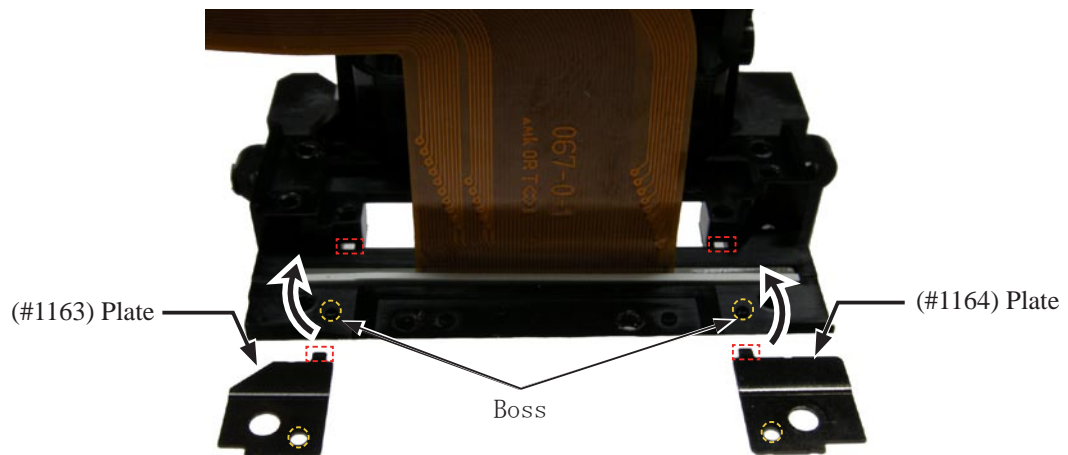

- Tighten the two screws (#1597).

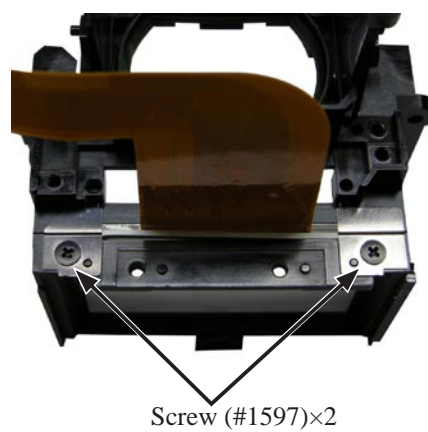

- Mount the finder frame (#1107).
(Be careful of the direction of mounting.)

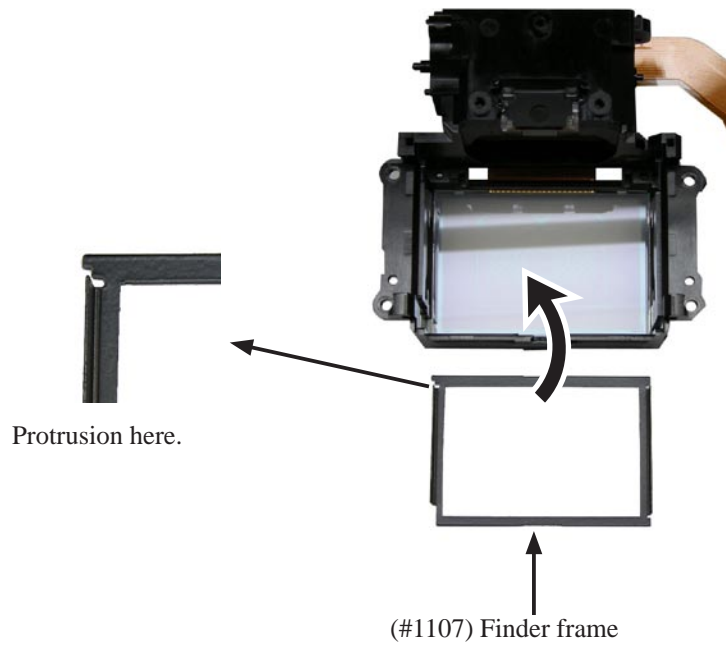

- Mount the condenser lens (#19).
- Mount the Spacer Frame (#1109).

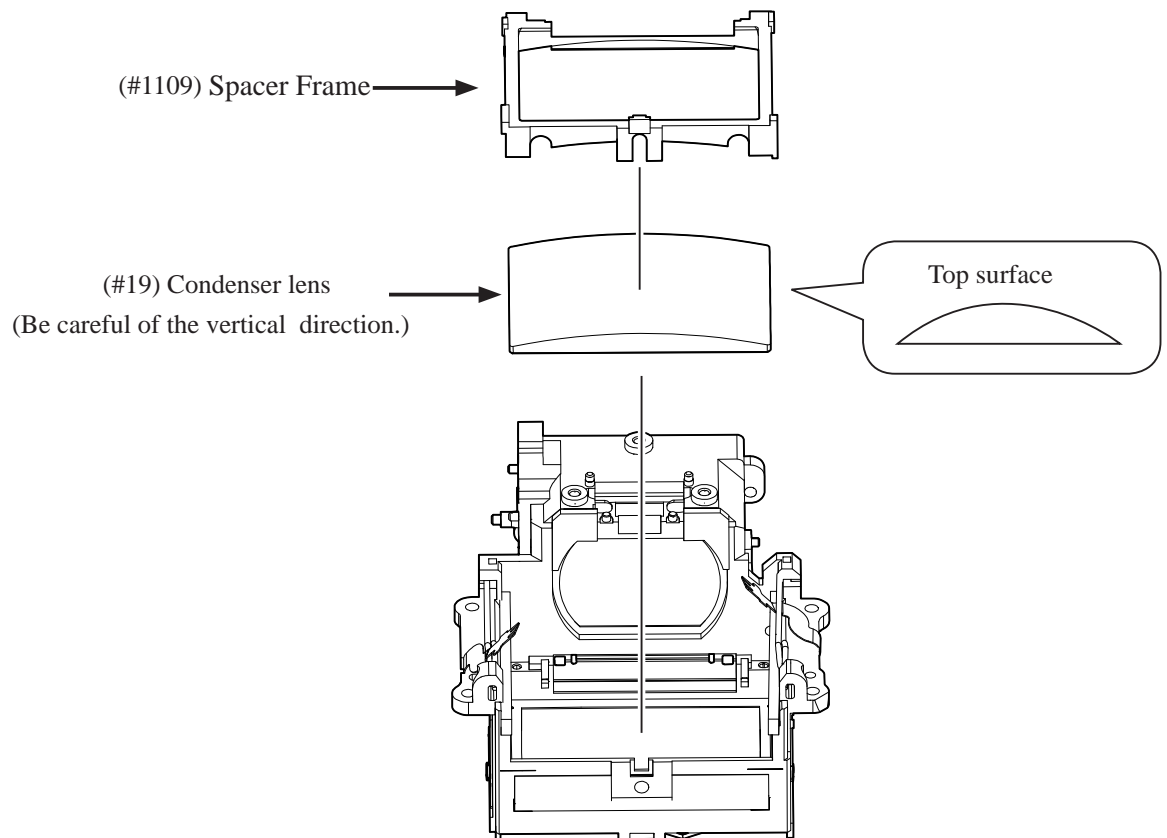

- Fold the SI LCD FPC (#5011).

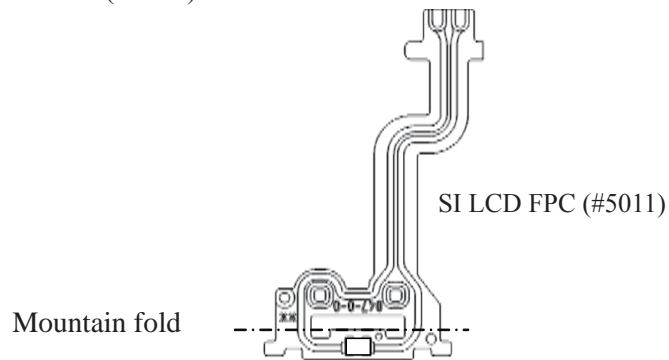

- Attach the FPC by fitting with the boss.
- Insert the edge of the FPC into the square hole at four places.
- Place so that the LCD chip can be fit in the central concave portion.

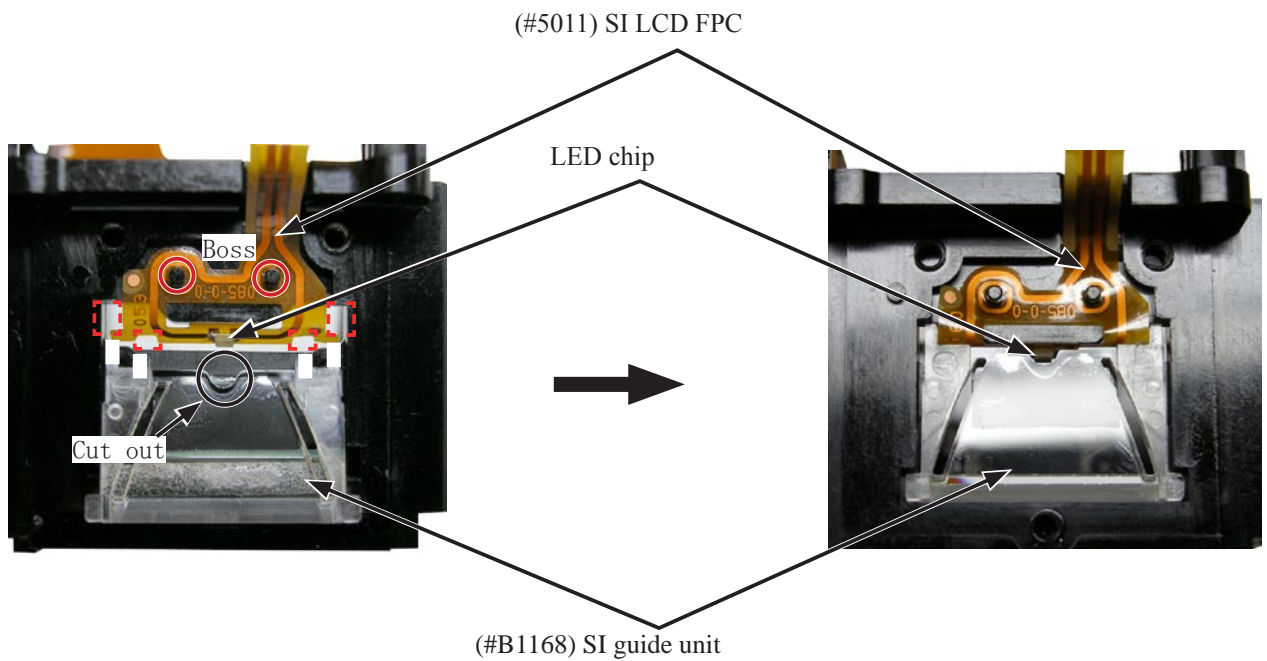

- Mount the plate (#1167), and tighten the three screws (#1597).

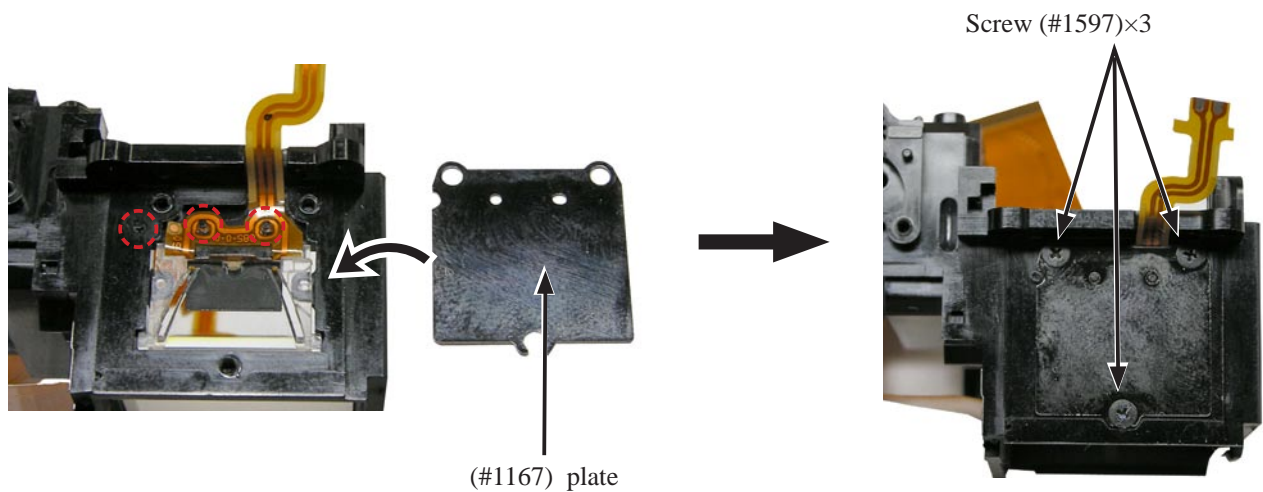

- Mount the lower display prism (#8).

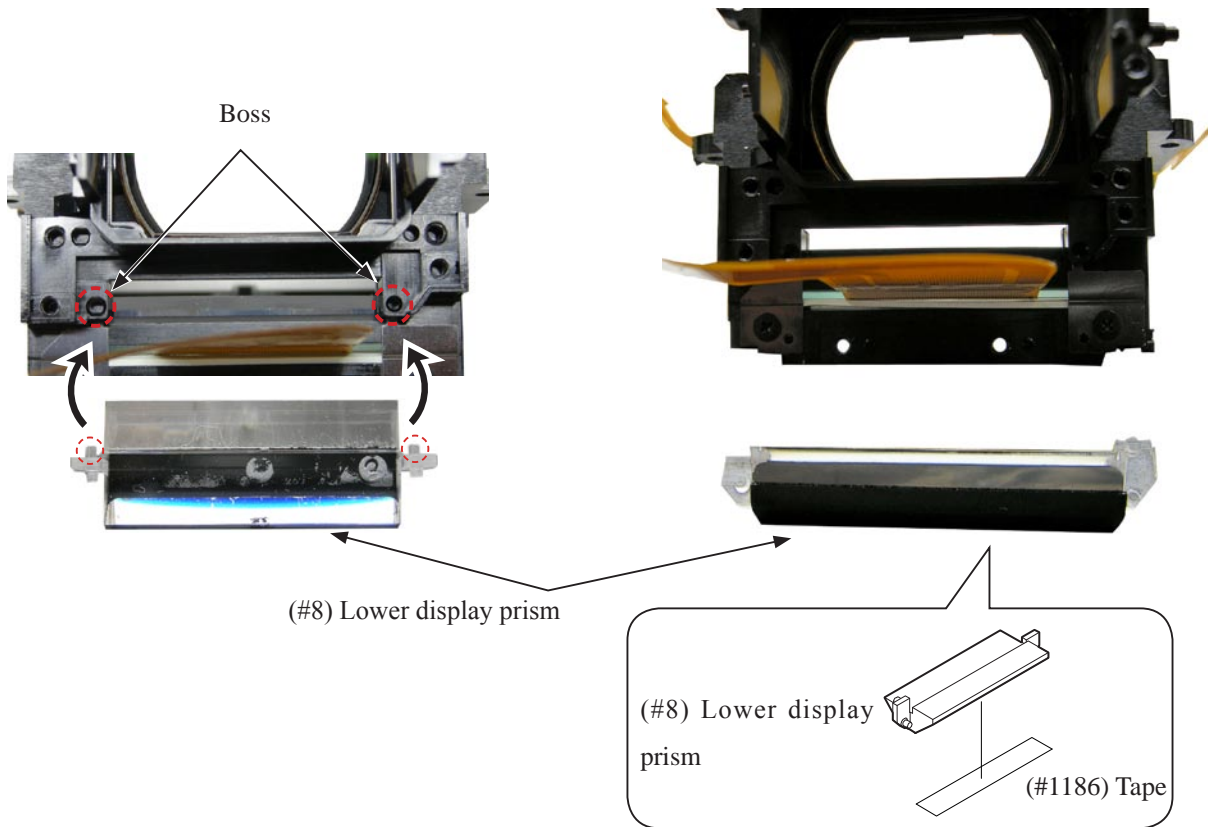

- Mount the two plates (#1185), and tighten the two screws (#1537).

(#1185) Plate ×2 (Be careful of the direction.)

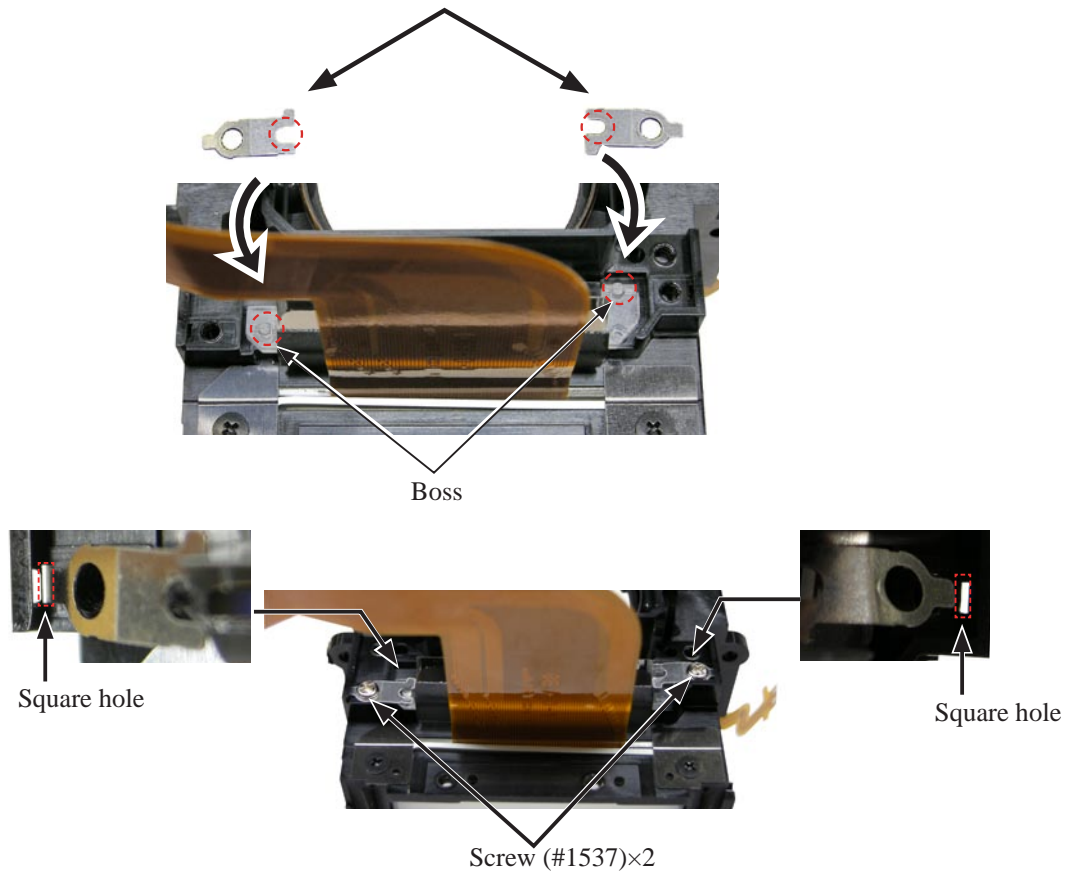

Inside finder LCD unit

- Mount the inside finder LCD unit (#B5004).

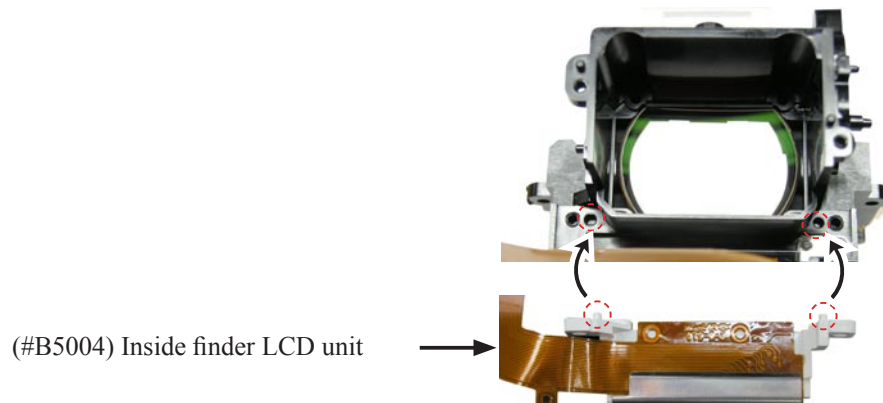

- Tighten the two screws (#1585).

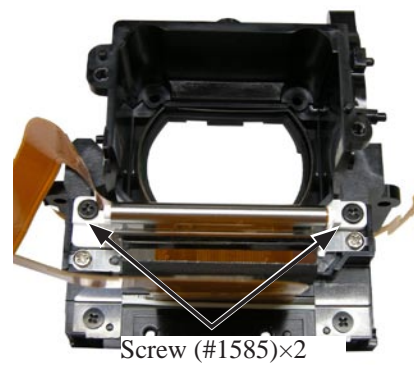

- Fit the FPC part of the inside finder LCD unit (#B5004) with the boss.

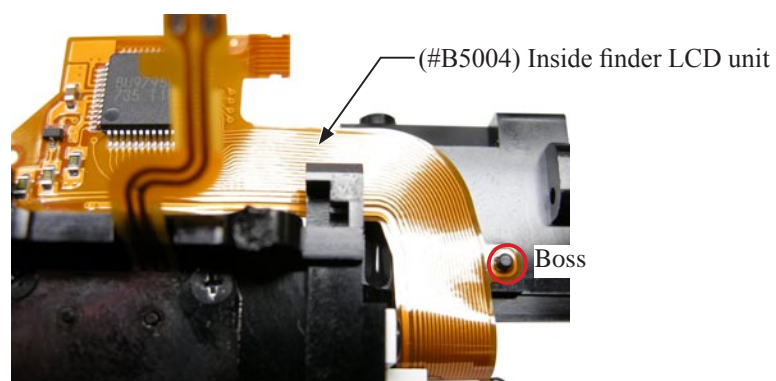

Diopter adjustment unit

- Insert the two diopter shafts (#1122) into each hole.
- Mount the Diopter Lens Unit (#B1118) by fitting in the holes through each shaft.

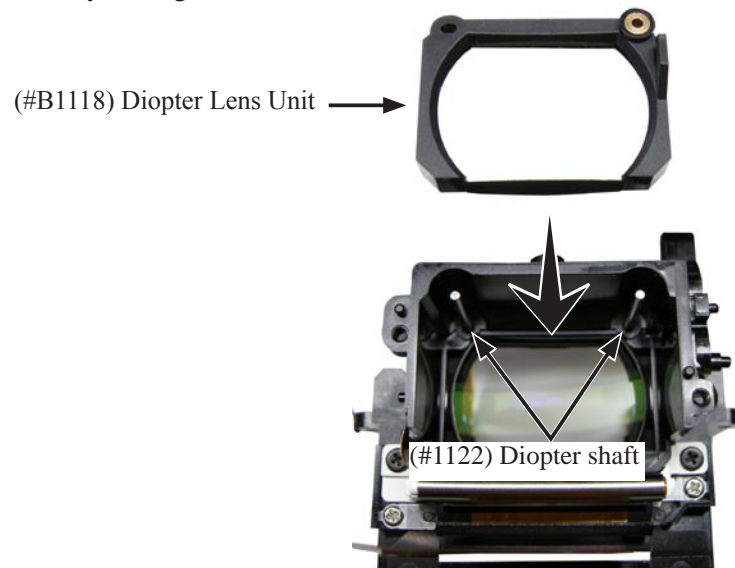

- Mount the Eyepiece Lens Unit (#B1119) by fitting with the boss.
- Tighten the two screws (#1595).

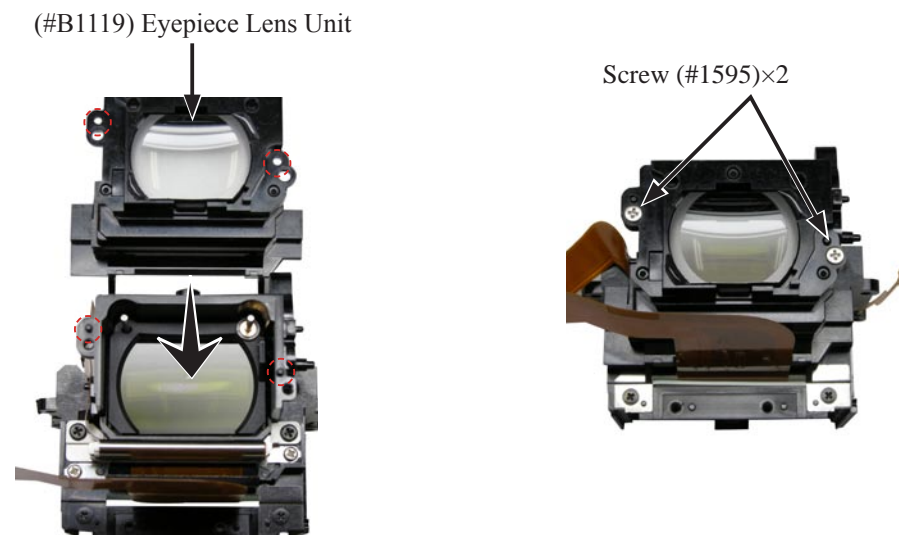

- Hook the plate (#1120) at two places as shown in the right picture, then tighten the two screws (#1597).

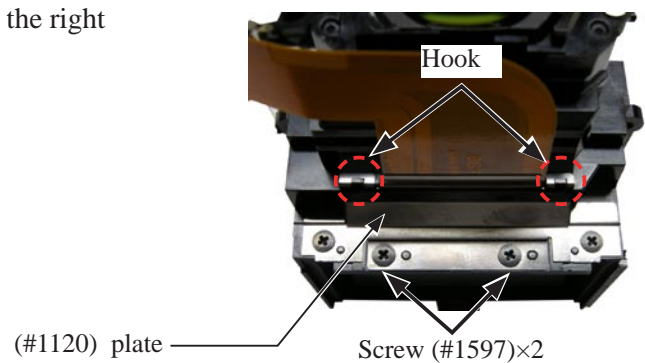

Diopter adjustment Mold

- Put the cam (#1128) in the groove of the Diopter Lens Unit (#1118).

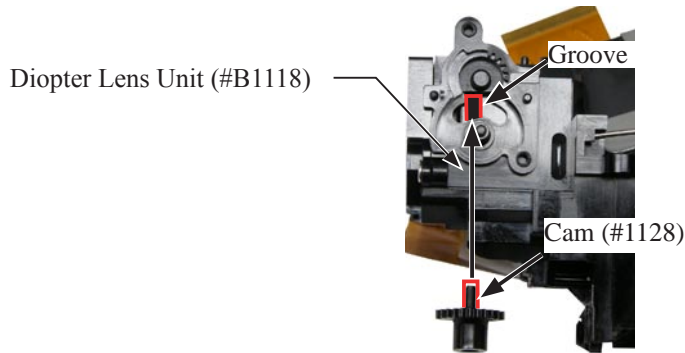

- Align the "▲" mark of the cam (#1128) with the "▲" mark of the gear (#1125), then assemble them.

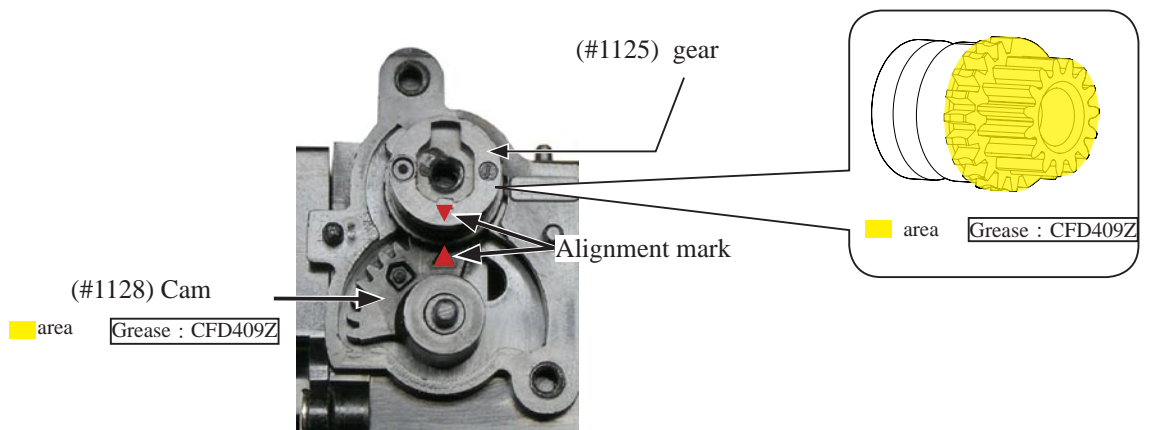

- Mount the mold (#1123) by fitting with the boss, and tighten the two screws (#1595).

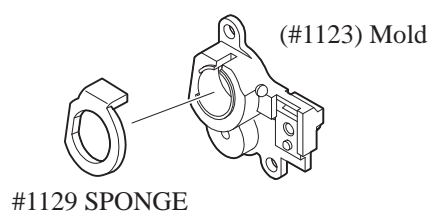

- Attach the steel ball (#1136) first, and then the click spring (#1127).

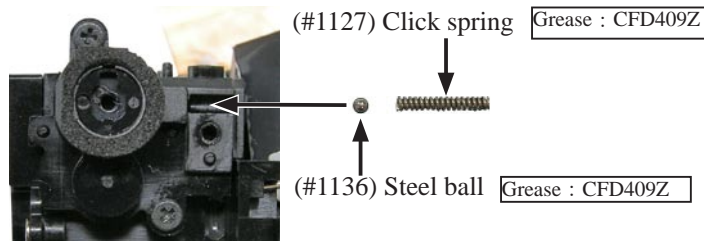

- Mount the plate (#1126), and tighten the screw (#1595).

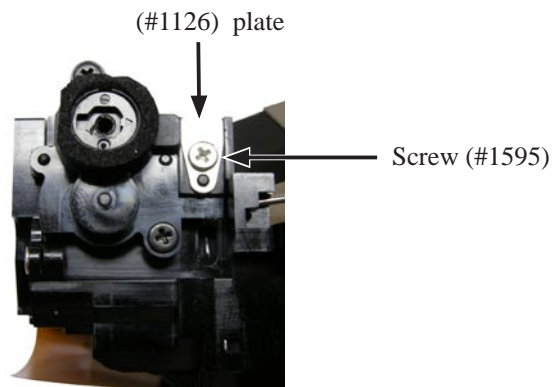

- Mount the finder frame (#1108), (being careful of the direction.)

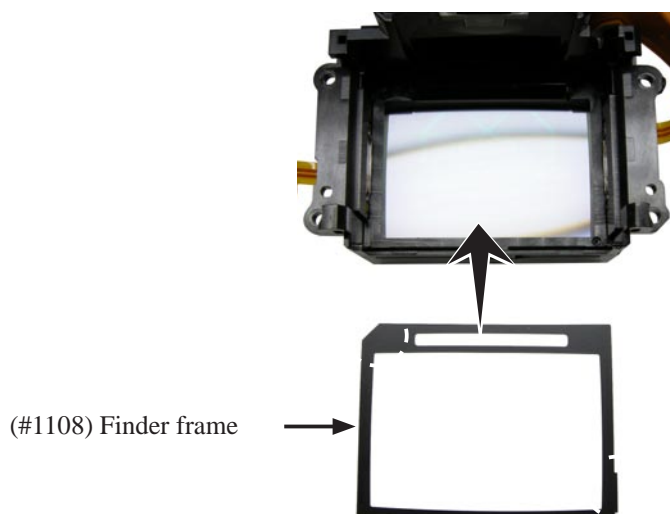

Penta prism

(#1196)DOUBLE STICK TAPE

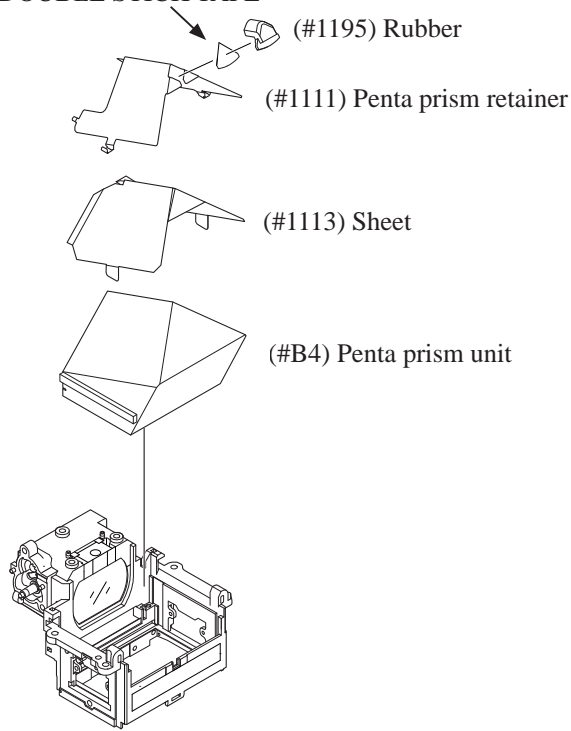

- Attach the spring (grip side; white)(#1215) and spring (I/F side; black)(#1112) to the hooks in numeric order.



- Attach the tape (#1203) by aligning with the marking-off line so that the tapes do not run off the edge of the prism box unit (#B1101RP).

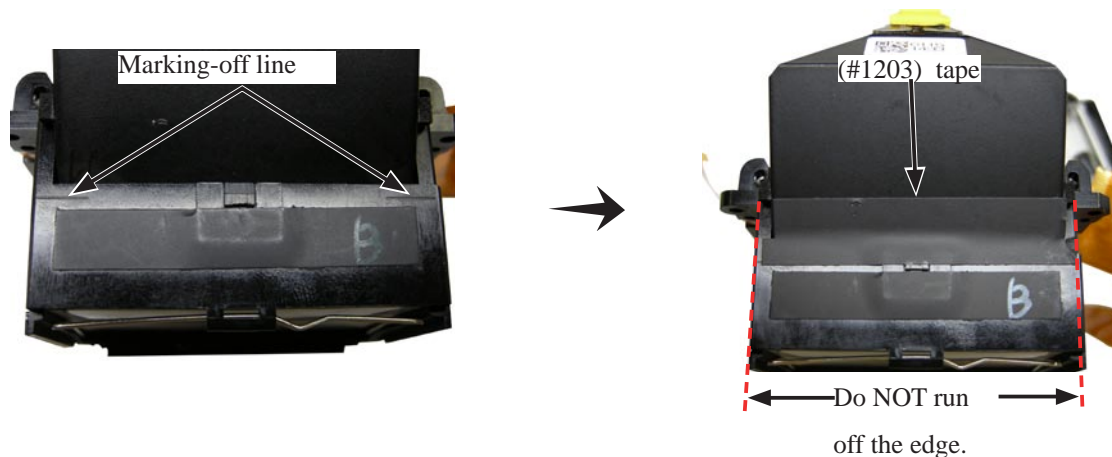

Screen

- Insert the both edges of the spring (#1103) into each hole of the prism box (#B1101RP).

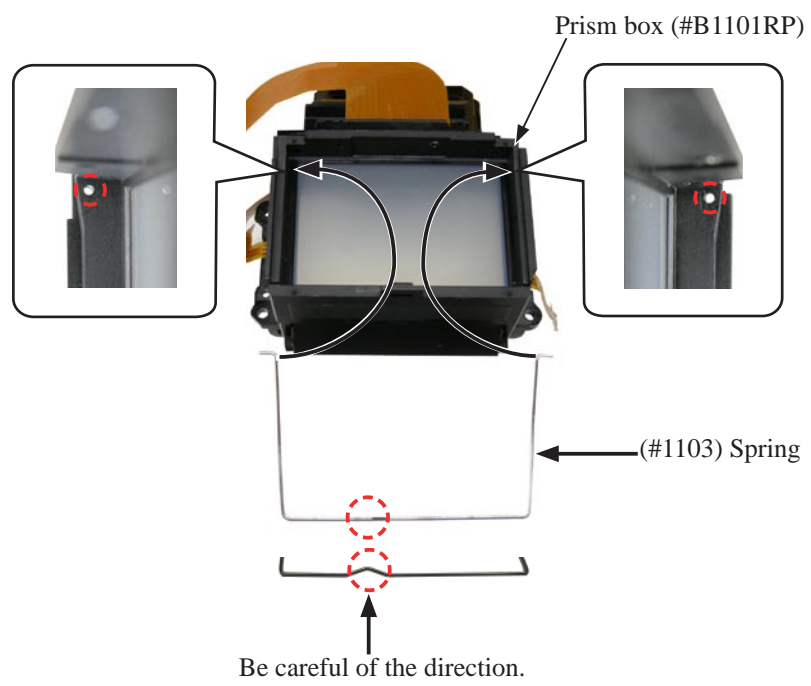

- Put the screen washer (#1180).
- Put the screen (#3).

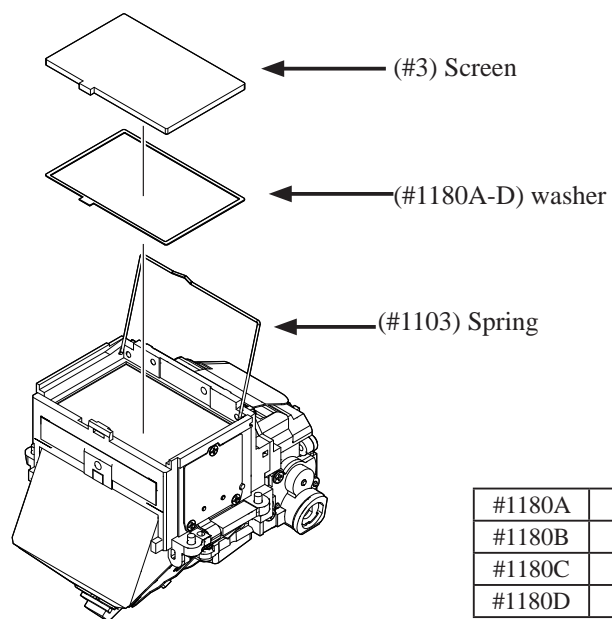

※ Page A138

#1180A	1K608-832	Screen washer	A	0.10mm
#1180B	1K608-833	Screen washer	B	0.20 mm
#1180C	1K602-840	Screen washer	C	0.15mm
#1180D	1K608-977	Screen washer	D	0.05mm

- Hook the spring (#1103) to the prism box unit (#B1101RP).

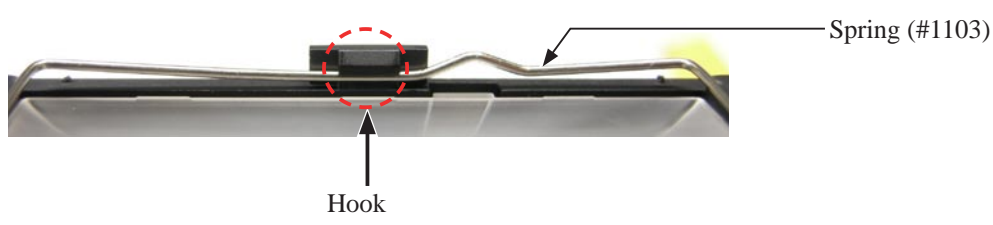

- Pass the boss of the penta prism retainer (#1111) through the hole of the penta FPC unit (#B5005) at two places.

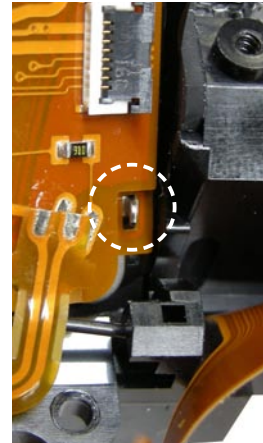

- Pass the flanged portion of the SI LED FPC (#5011) into the hole of the penta FPC unit (#B5005) at two places.

Penta FPC unit (#B5005)

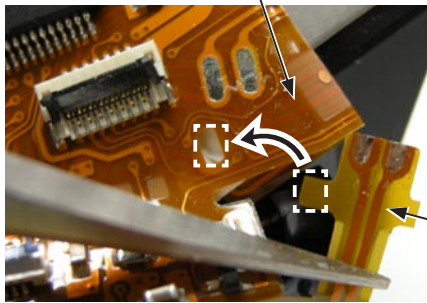

SI LED FPC (#5011)

Penta FPC unit (#B5005)

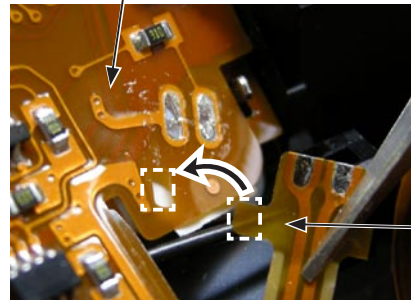

SI LED FPC (#5011)

- Solder as below.

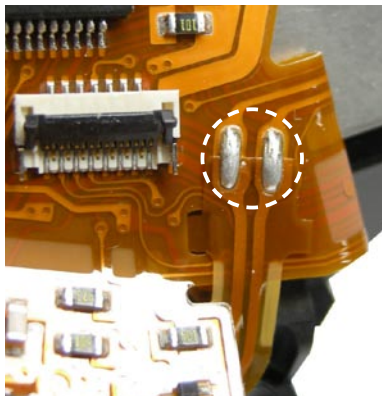

Metering FPC unit

- Mount the metering FPC unit (#B5006).

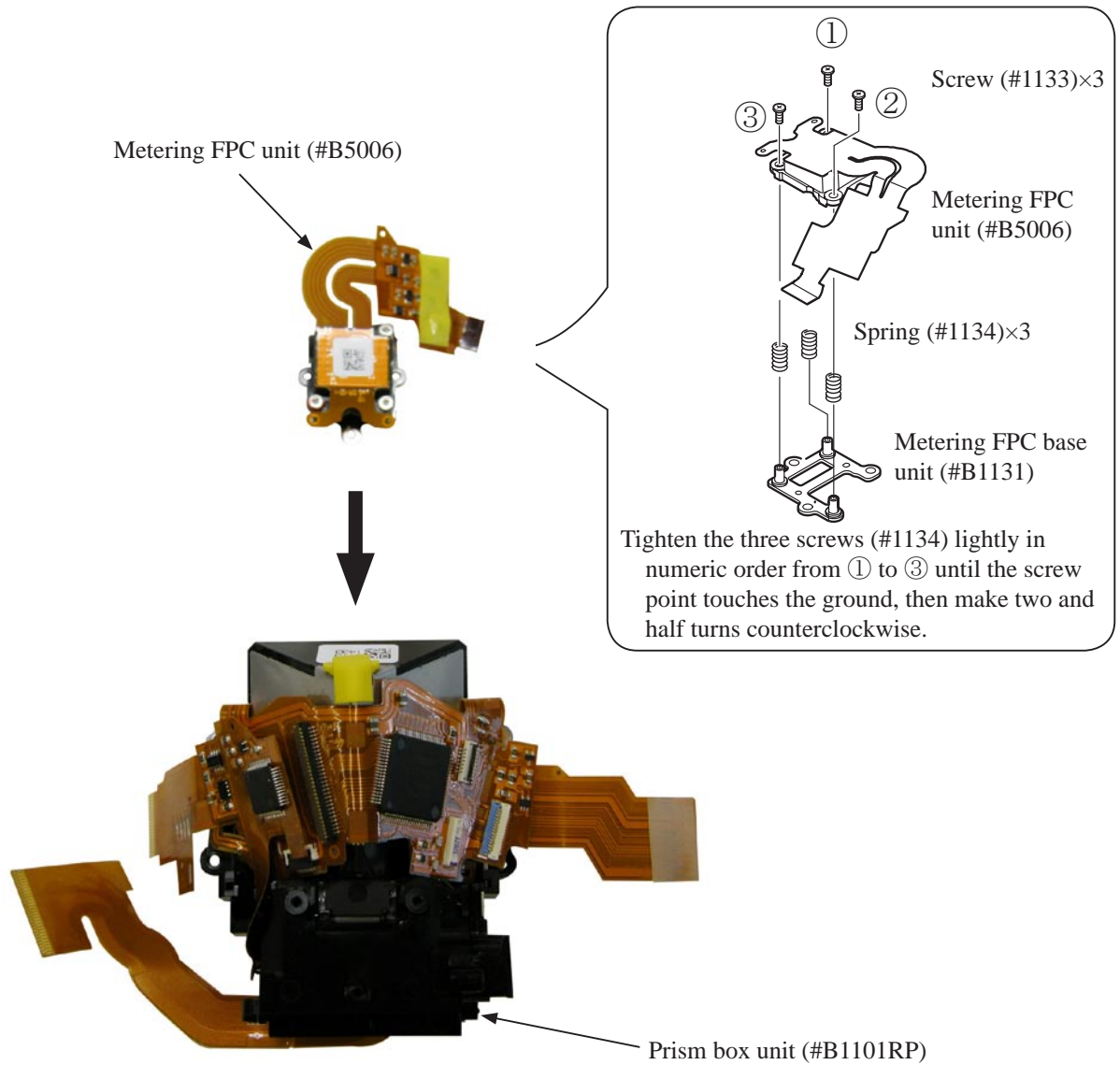

- Tighten the three screws (#1541) in numeric order (① → ② → ③).

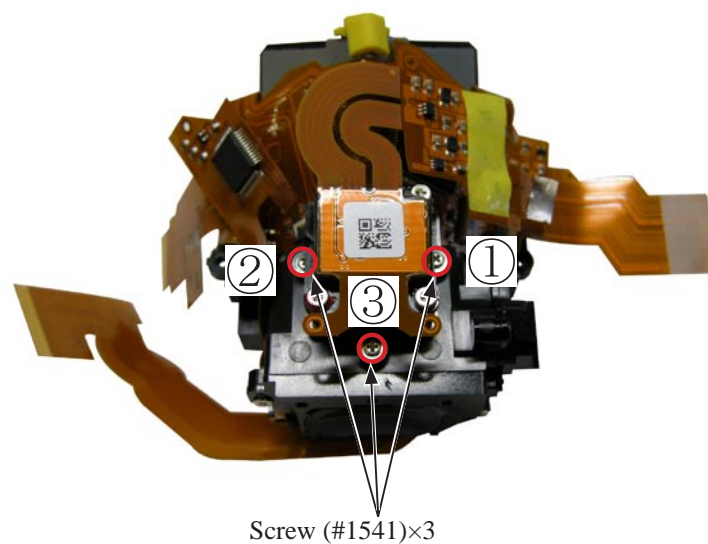

4. Mounting of Prism box unit on Front body unit

Mounting of prism box unit on front body unit

- Mount the prism box unit (#B1101RP).

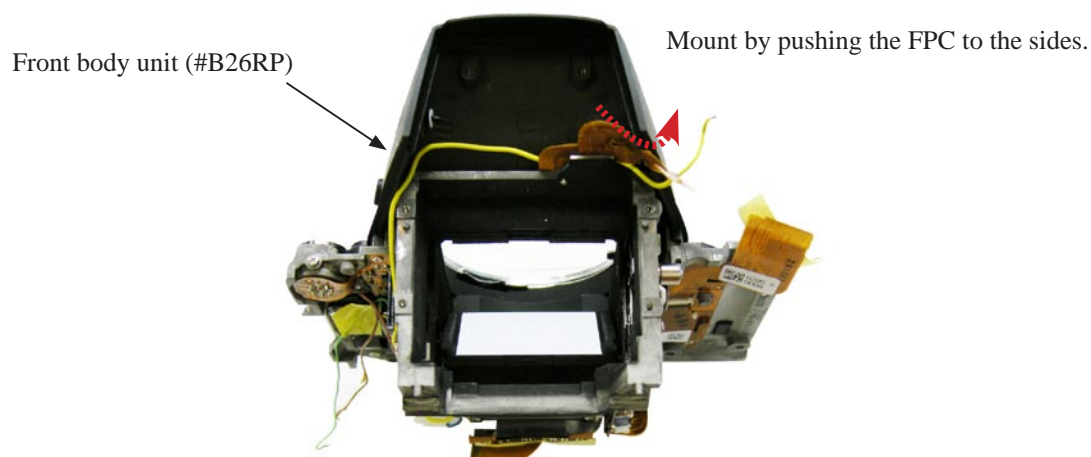
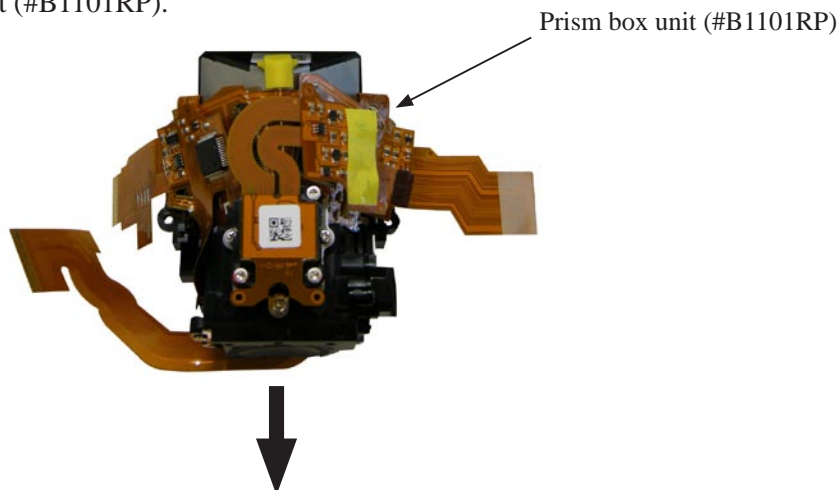

- Tighten the four screws (#1525) in numeric order (① → ② → ③ → ④).

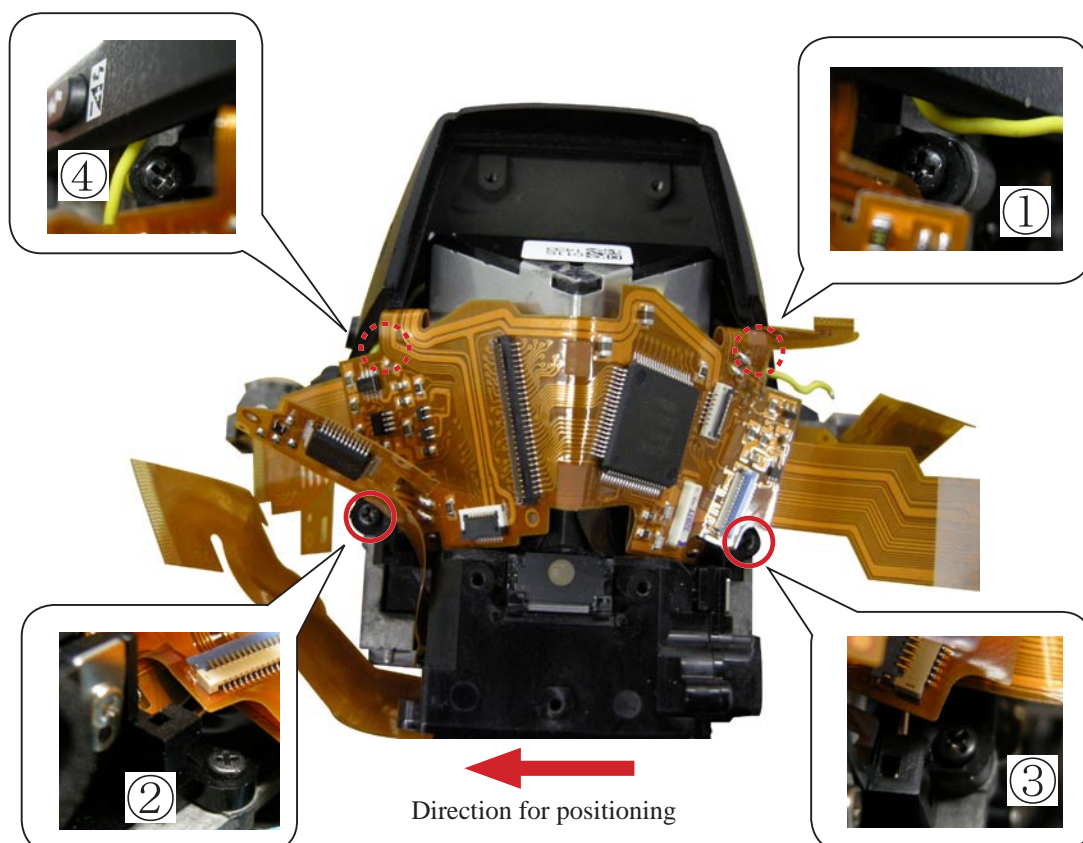

- Connect the FPC to the connector at two places.

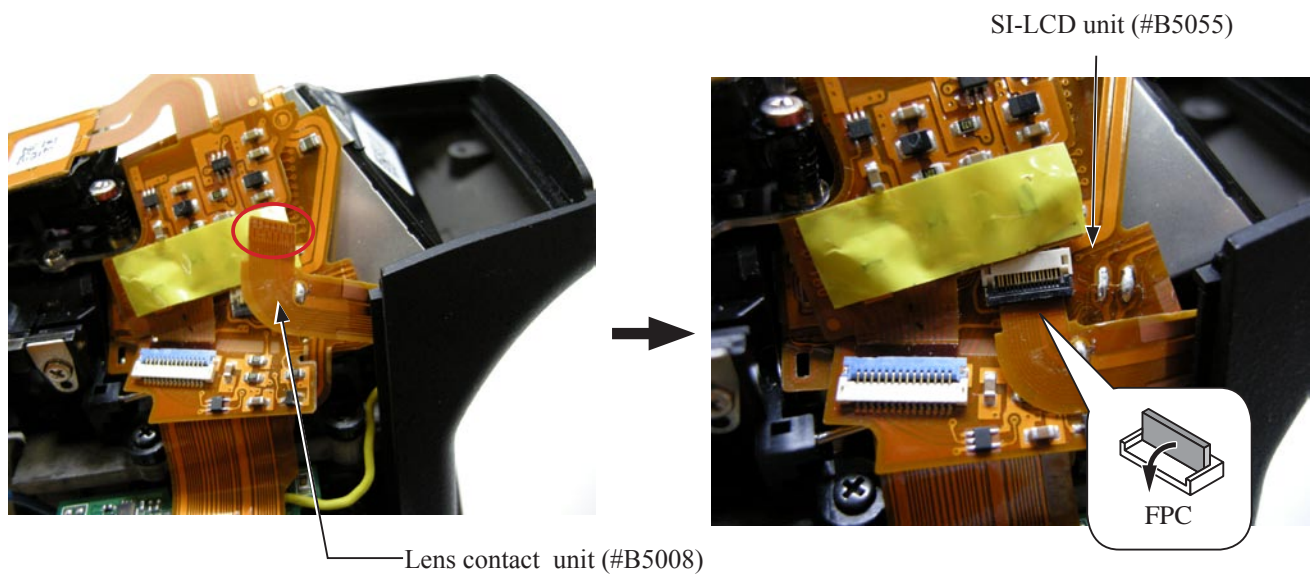
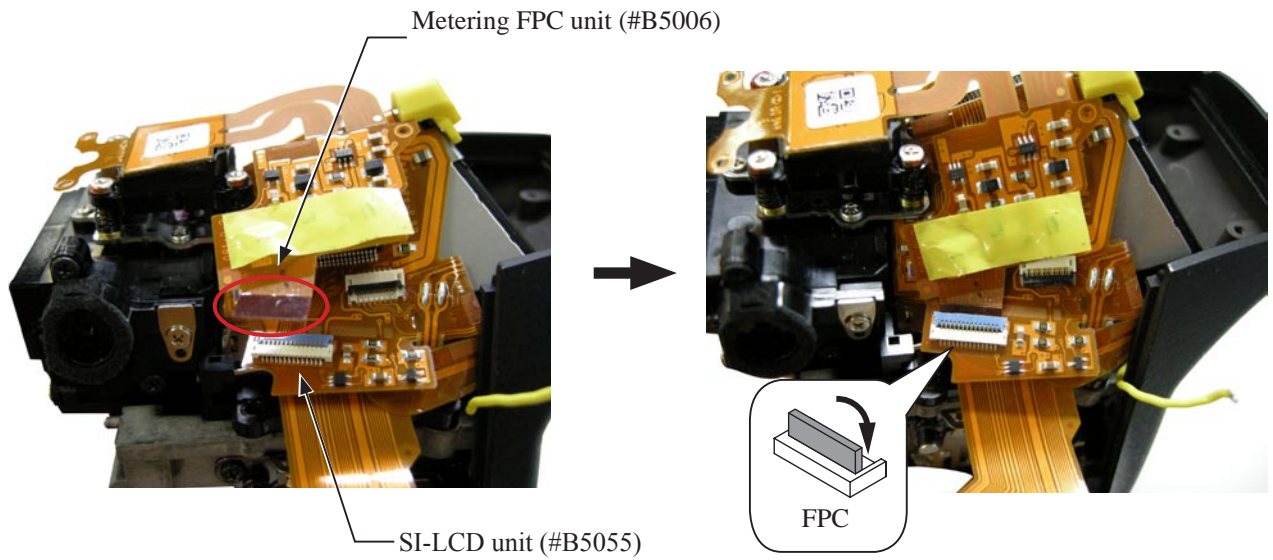

- Confirm that the FPC edge of the inside finder LCD unit (#B5004) is in the inner cutout section of the prism box unit (#B1101RP) as below.

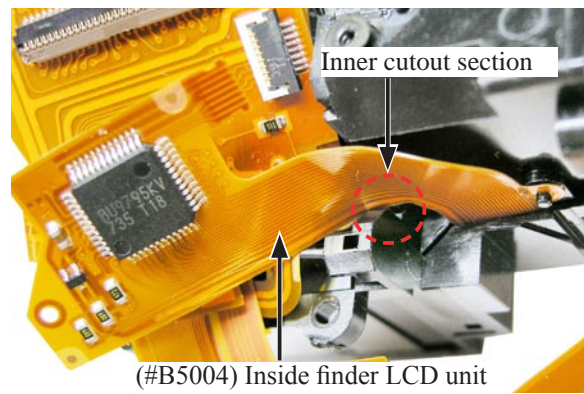

- Connect the FPC to the connector, (being careful of the direction of the connector.)

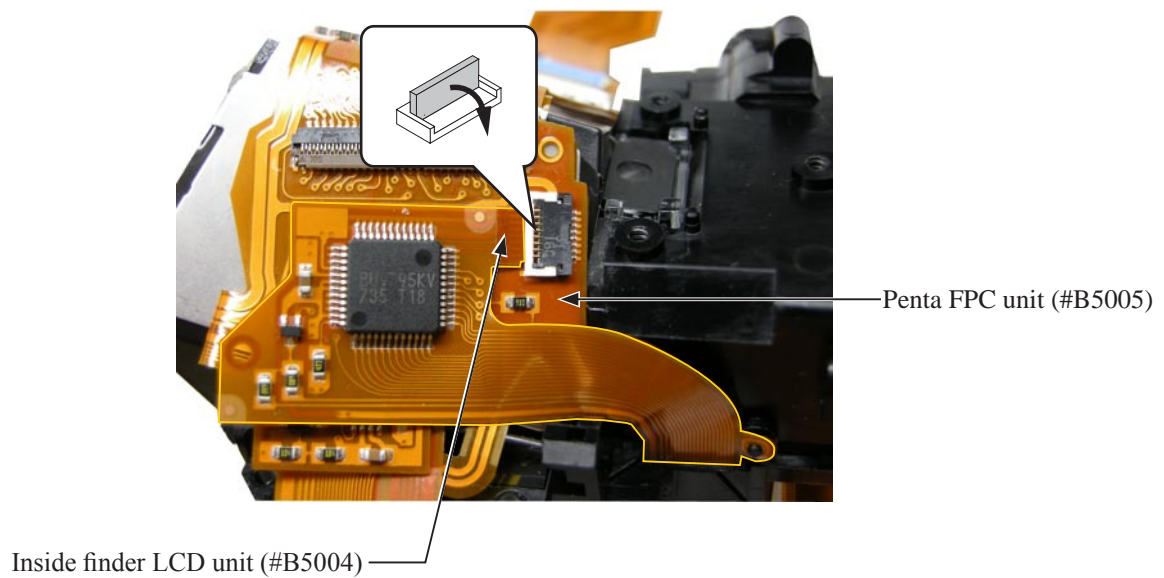

- Confirm that the FPC edge of the SI-LCD unit (#B5055) is in the cutout section of the prism box unit (#B1101PR) as below.

FPC of SI-LCD unit (#B5055)

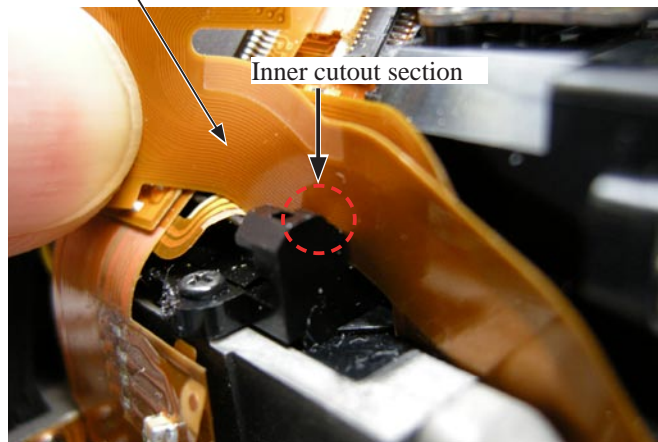

- Connect the FPC to the connector.

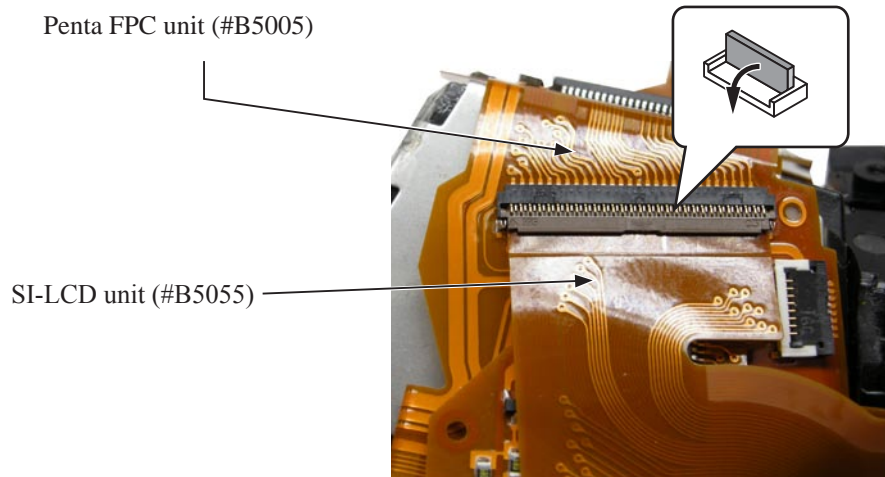

- Connect the FPC to the connector.

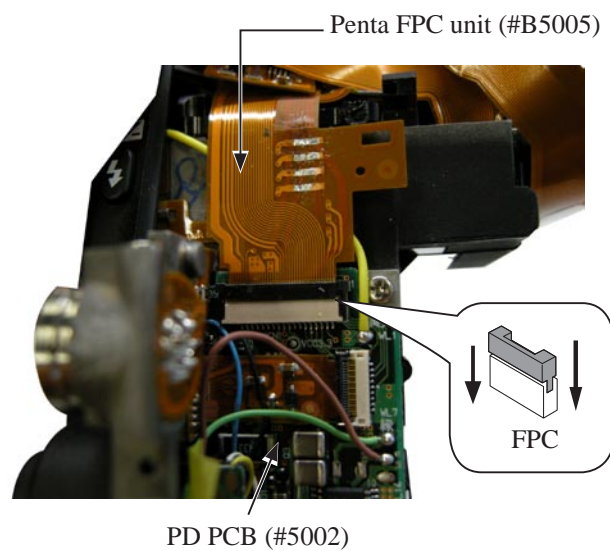

Angle adjustment of Main mirror and sub-mirror

※ Procedure: Follow the operating instructions of the tool for main/sub mirror angle-inspection (J19132).

• Main mirror 45° adjustment

Caution: Before and after the adjustment, check the accuracy by moving the main mirror up- and downwards a few times.

① Check for the right-left deviation

In case the result is out of standard, loose the three screws (#1520), then make the adjustment by turning the eccentric pin that is for the right-left adjustment.

② Check for the up-down deviation.

In case the result is out of standard, make the adjustment by turning the eccentric pin that is for the main mirror.

• Sub-mirror 54° adjustment

Caution: Before and after the adjustment, check the accuracy by moving the main mirror up- and downwards a few times. Confirm if the two-pronged part of the sub-mirror firmly fits in the eccentric pin.

① Check for the up-down deviation

In case the result is out of standard, make the adjustment by turning the sub-mirror eccentric pin.

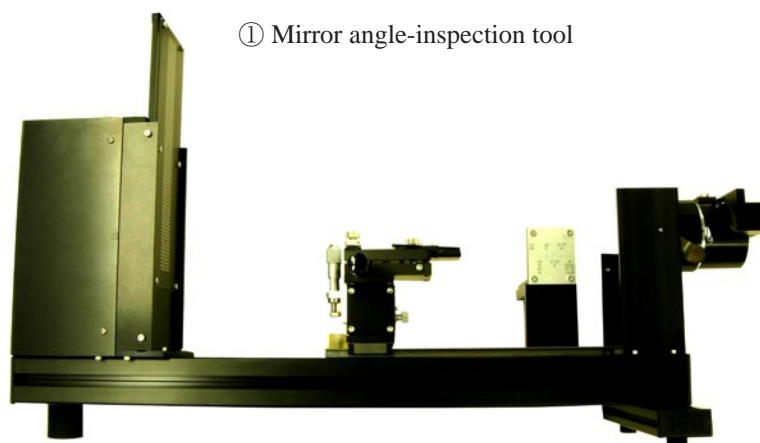

Caution : Do NOT release the shutter.

△ (Revision)

Set the (supplied) tilted mirror with the main mirror being slightly lifted so that the sub-mirror of $\text{D}300$ does not touch the (supplied) tilted mirror of the inspection tool. D700

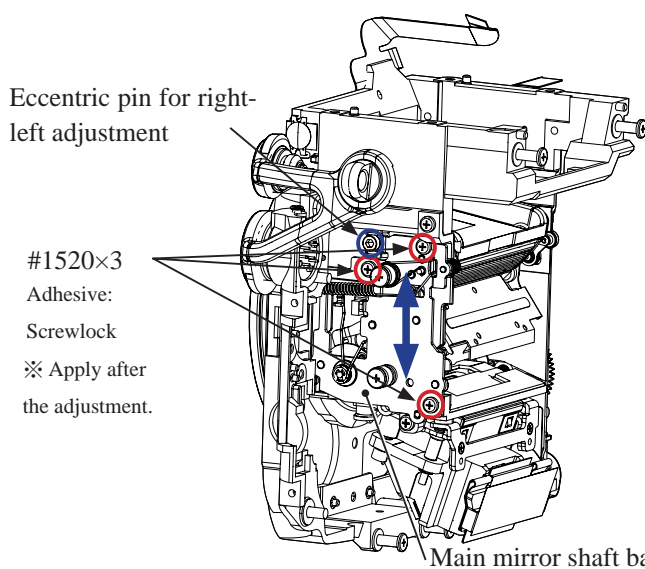

#1520×3
Adhesive:
Screwlock
※ Apply after
the adjustment.

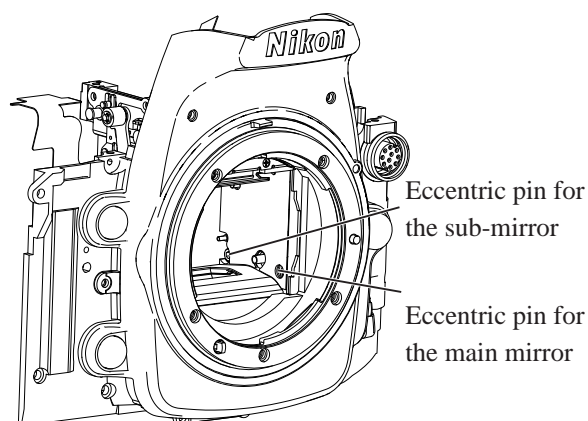



When the right-left deviation is adjusted, remove the power drive PCB for the adjustment.

< Standard value >

	Main mirror	Sub mirror
Left-right deviation	0 ±10	-
Up-down deviation	±5'	-10' ~ 0'
Distortion	5' or less	8' or less

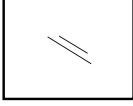
Device

△ (Revision)		
 J19132 MAIN/SUB MIRROR ANGLE INSPECTION TOOL	 H15432 J15433 45 DEG ANGLE MAIN-MIRROR TOOL FOR D700	 HEX. KEY WRENCH (φ1.5mm)

5. Mounting of Front body on Rear body

Mounting of front body on rear body

- Check the initial position of the charge PCB.

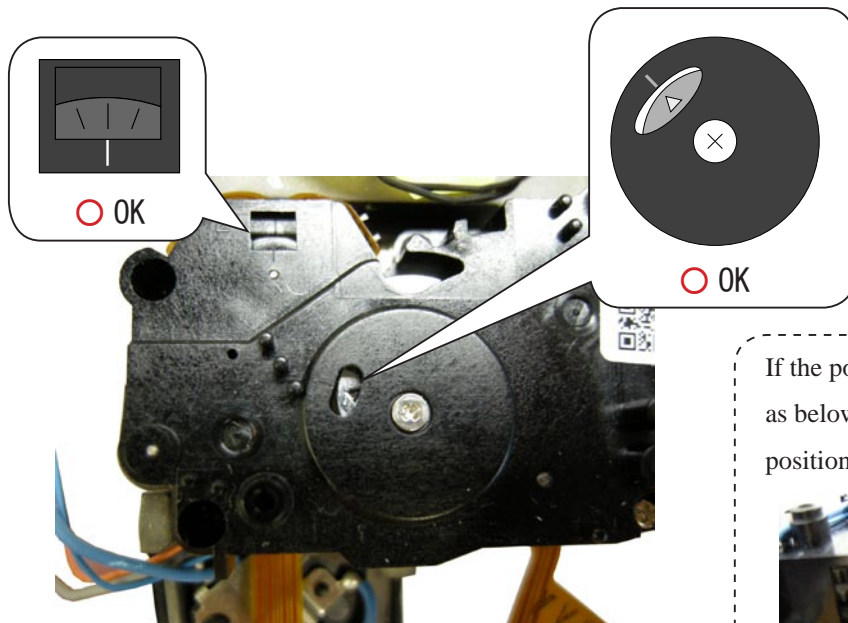

If the position is misaligned, turn the blue gear as below and adjust so that the indications are positioned correctly.

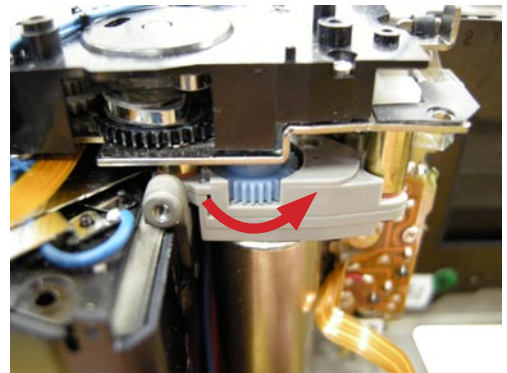

- Check the initial position of the shutter.

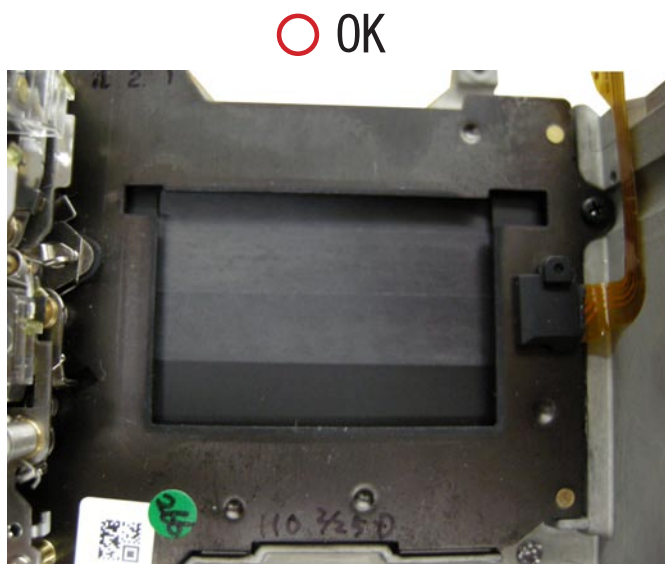

The shutter curtains are positioned horizontally, so no caulking is seen on the face.

× NG

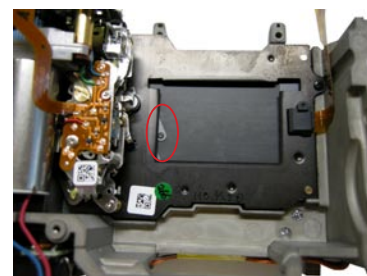

Caulking is seen on the face.

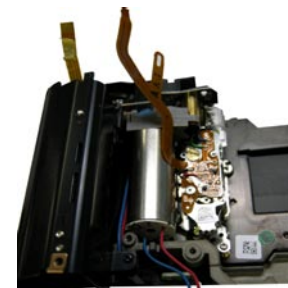

3V : - +

In case caulking can be seen on the face, apply voltage (3V) to the charge motor so as to become initial status.

- Check the status when the mirror is down.

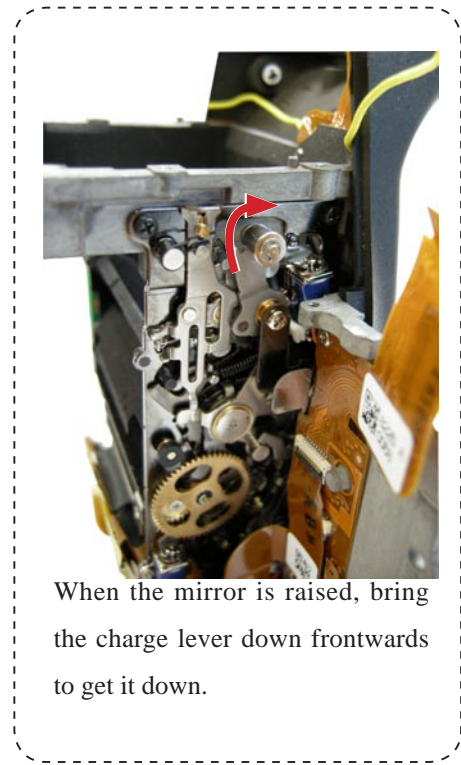
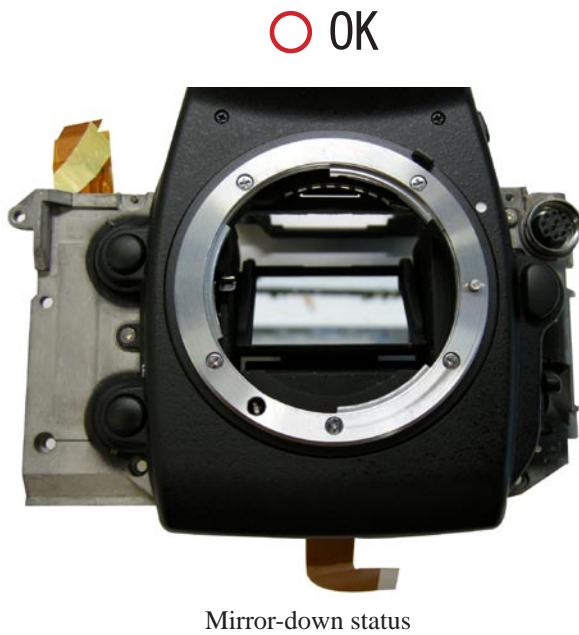

- Mount the front body unit (#B26RP) on the rear body.

Caution: The boss must be fit securely.

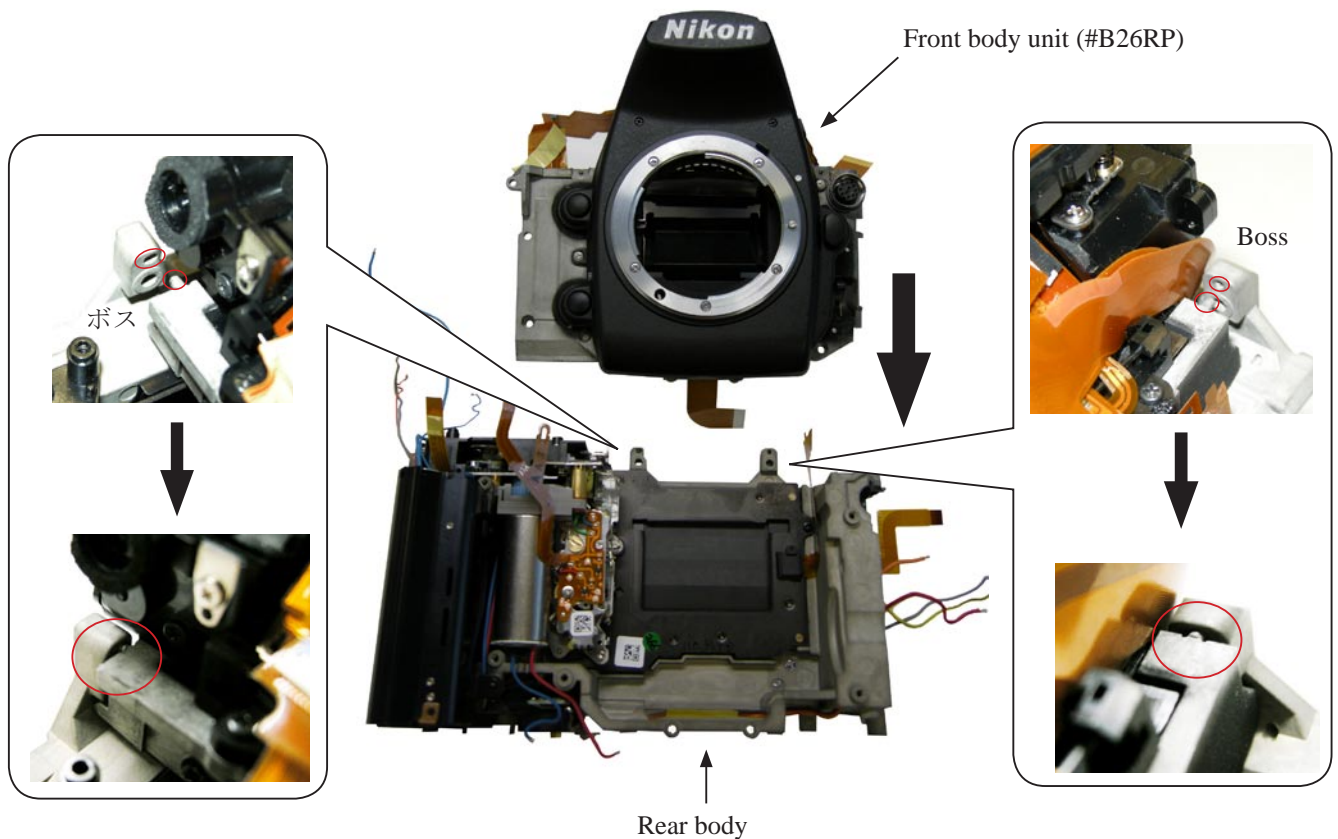

- Tighten the four screws (#1531) in numeric order (① → ② → ③ → ④).

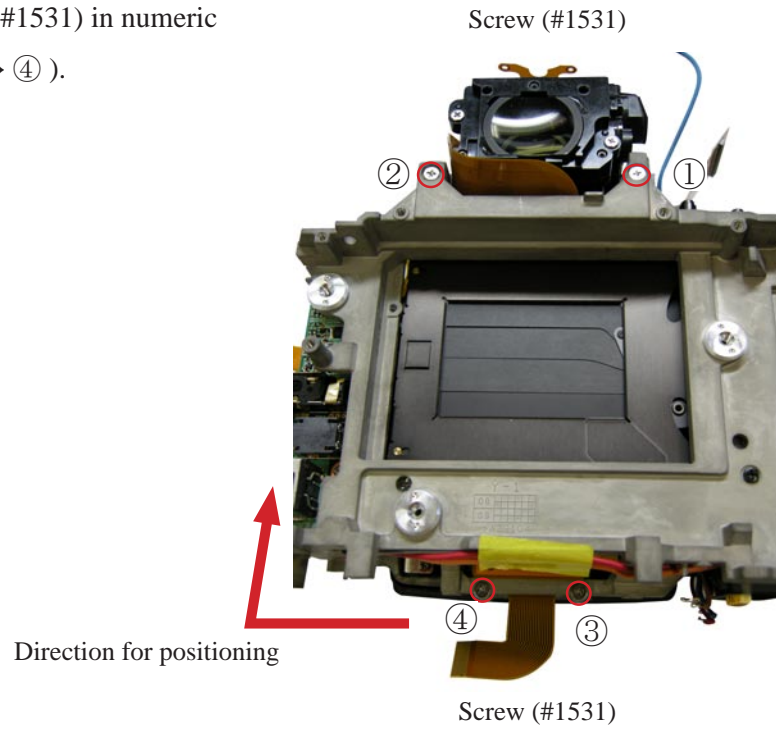

- Tighten the five screws (#1575) in numeric order (① → ② → ③ → ④ → ⑤).

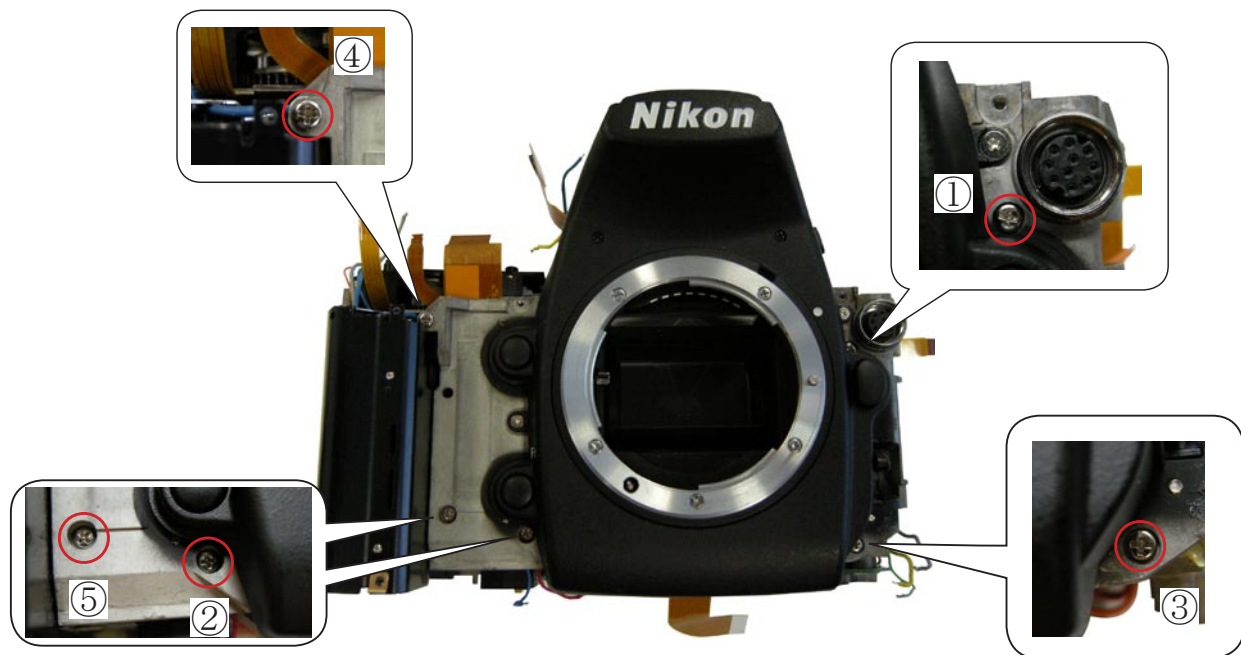

- Tighten the screw (#1525).

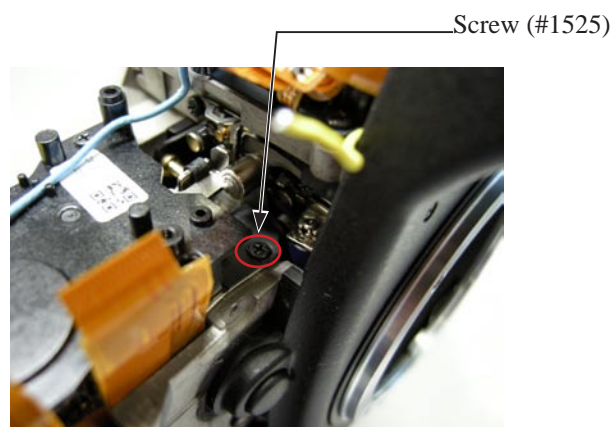

Inspection and Adjustment of Body back

• "0" positioning of the dial gauge

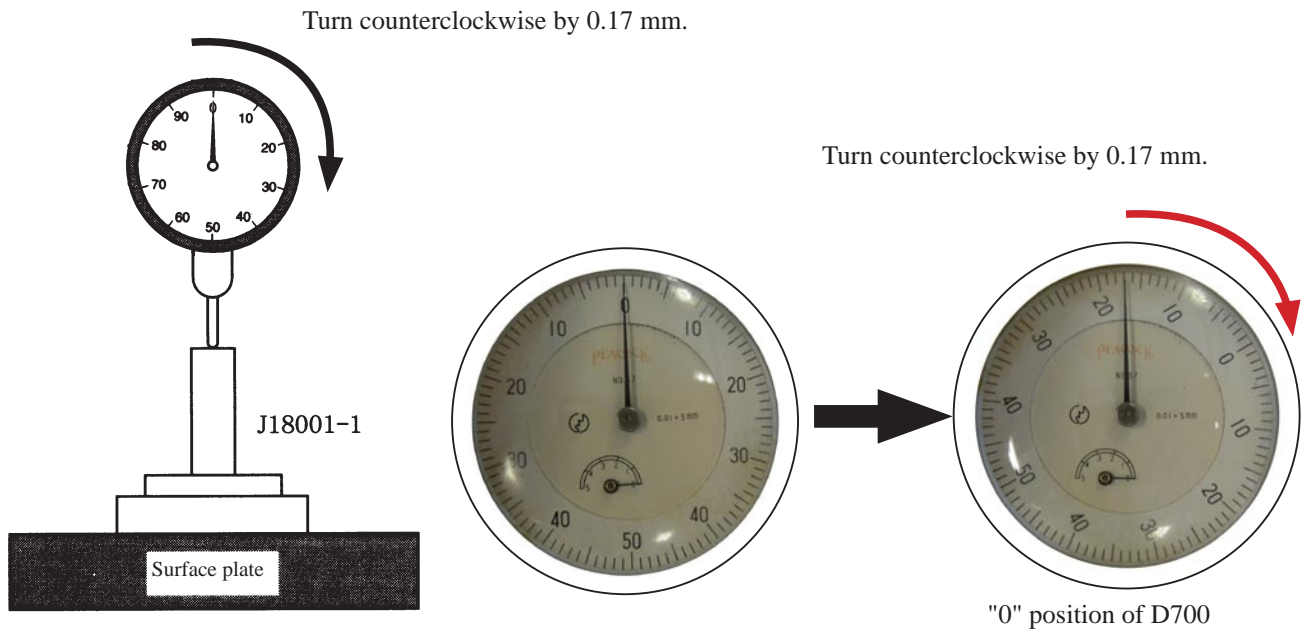

- (1) Mount the tool (J18001-1) on the surface plate as above, then set the dial gauge to "0".
- (2) From "0" position of (1), turn the index circle in the direction of the arrow so that the needle is on "0.17mm". (This position is "0" position of D700.)
- (3) Measure the body back based on "0" position of the index circle.

• "0" positioning of the digital gauge

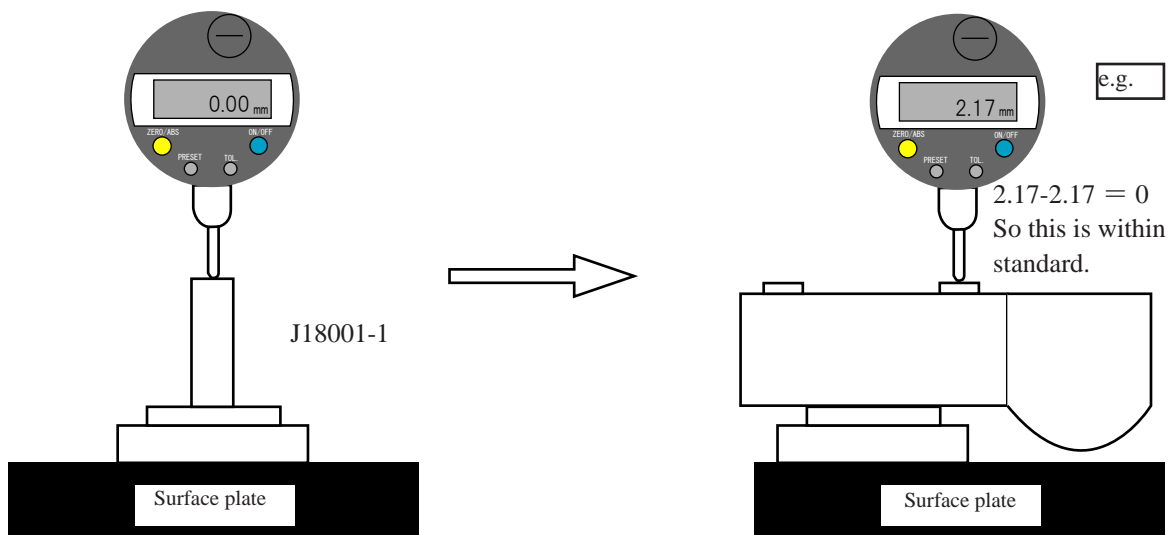

- (1) Mount the tool (J18001-1) on the surface plate as above, then turn the digital gauge ON and press [ZERO/ABS] button so that the value becomes "0".
- (2) Measure the body back based on "0" position
- (3) Subtract "2.17mm" from the measured value. If the value is "0±0.01 mm / Parallelism: 0.015mm or less", it is within standard.

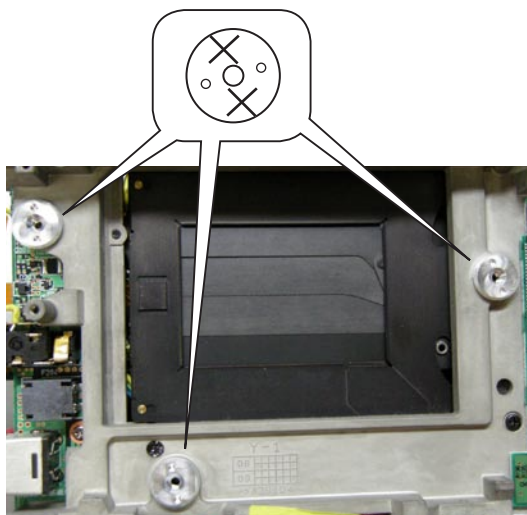

- Measure six places from the bayonet face to the image PCB attaching face.

× mark: to be measured

Standard: 48.84±0.01mm / Parallelism: 0.015mm or less

- In case the result is out of standard, make an adjustment by putting the washers between the front body and the rear body.

Note: For some bodies, the washer(s) is/are already put on the attaching face of the image PCB . There is a **red mark** indication at the following two positions.



1. Indication: on the attaching face of the camera body side
Purpose : To adjust the height of the camera body
2. Indication: on the attaching face of the image PCB side
Purpose : To adjust the height of the image PCB
3. Indication: at the corner edge on the attaching face of the image PCB side
Purpose: To adjust and position the image PCB

Therefore, in case of the above 1., when the camera body is disassembled or the image PCB is replaced, put the washer at the original position. In case of the above 2 and 3, when the image PCB is replaced, remove the washer.

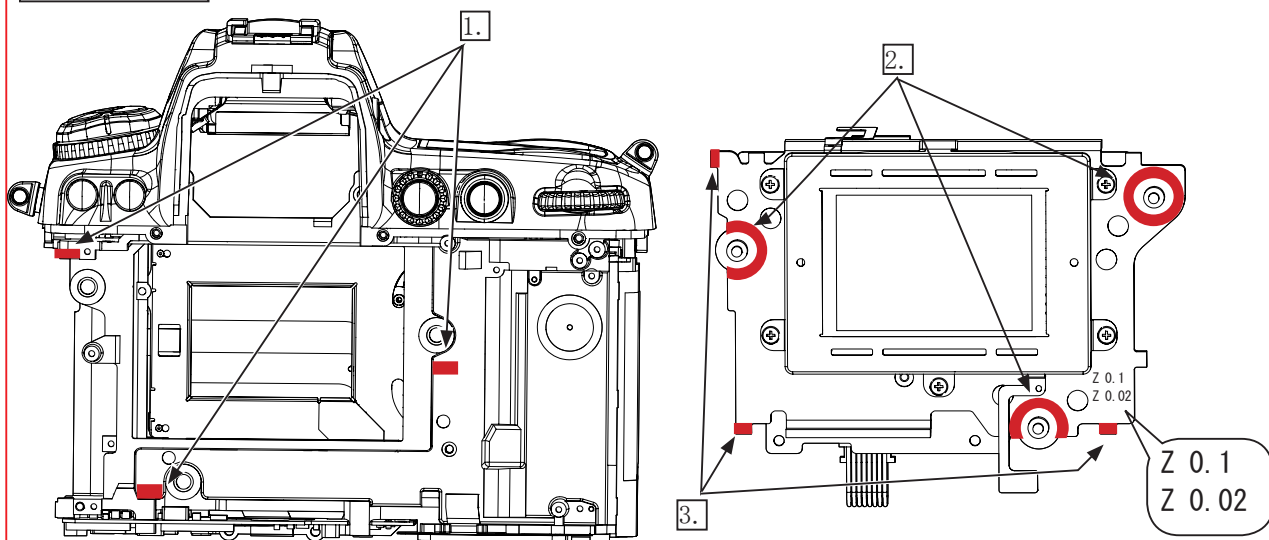
Mark indication



Device

 DIAL INDICATOR AND STAND	 BODY BACK FOCUS GAUGE
---	---

- Pass the FPC edge of the shutter unit (#B12001) through the hole of the penta FPC unit (#B5005), then solder at four places.
- Attach the tape [#TA-0005 (10 × 20)].

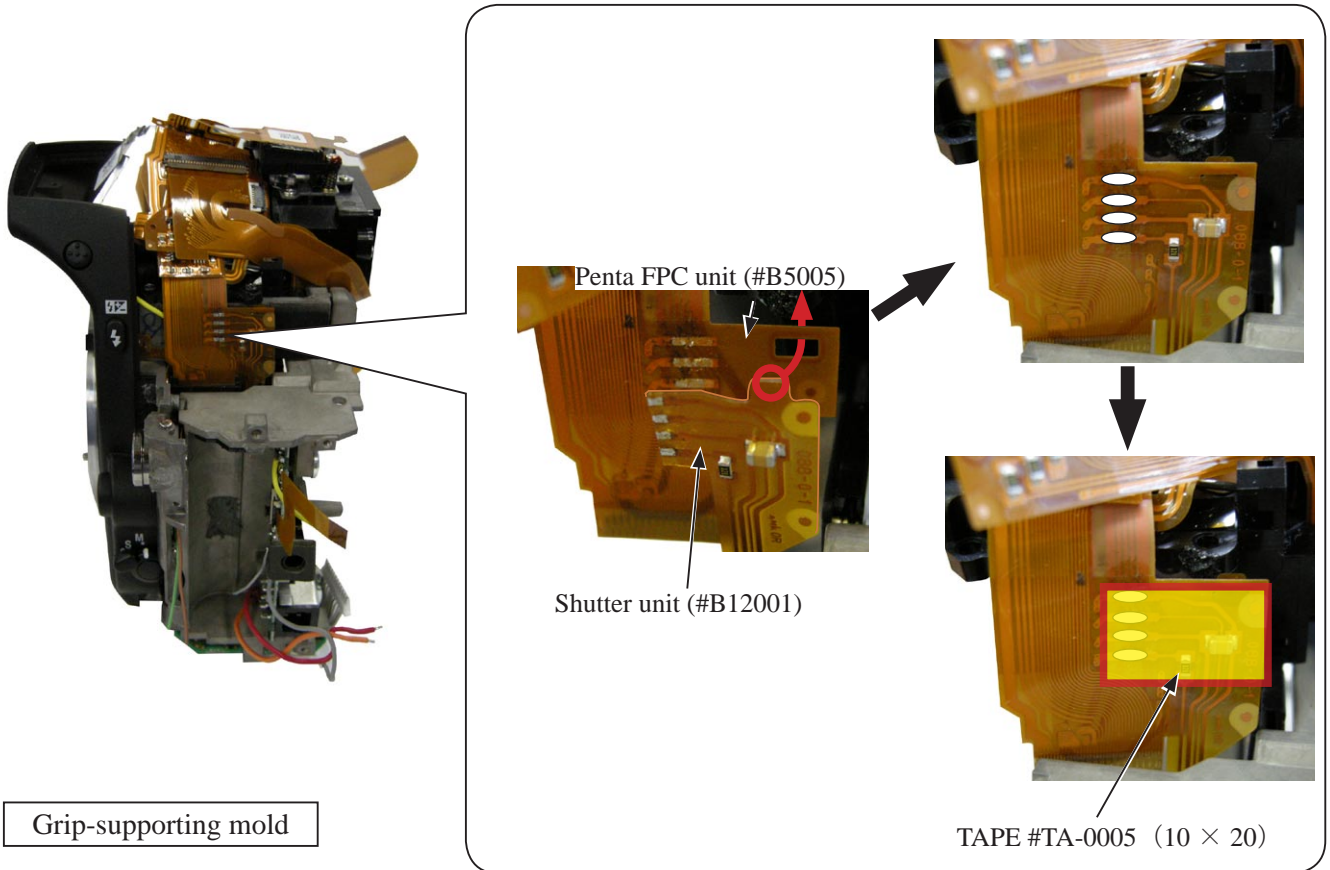

Grip-supporting mold

- Attach the sponge (#952) to the grip-supporting mold (#58).
- Attach the grip-supporting mold (#58).
- Tighten the screw (#1644).

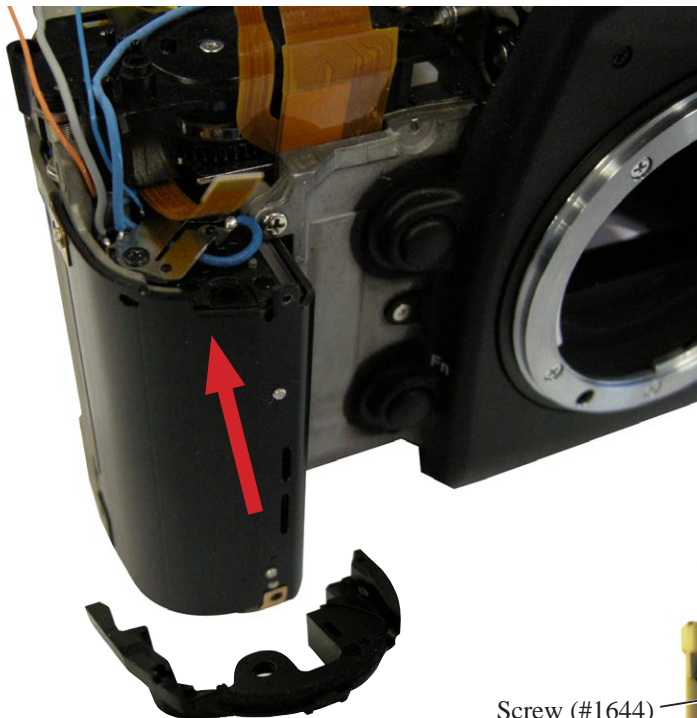

Grip-supporting mold (#58)

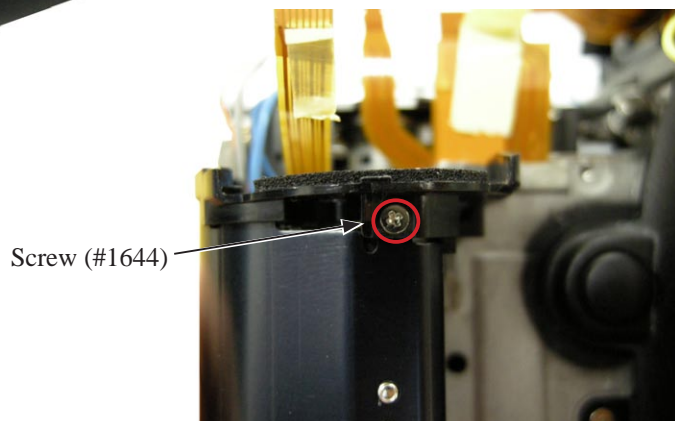
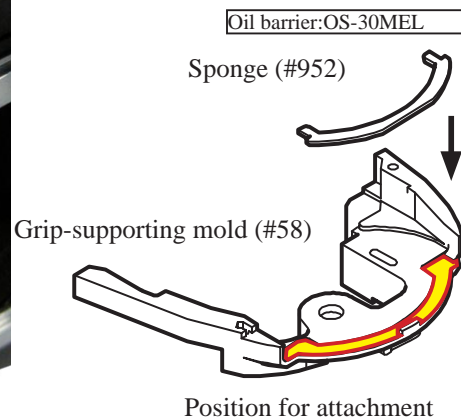

Screw (#1644)



AF-assist lamp

- Attach the Sponge (#325) to the AF-assist lamp unit (#B326).

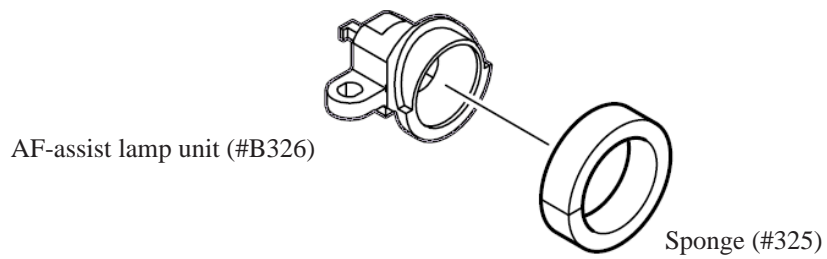

- Mount the AF-assist lamp unit (#B326).
- Tighten the screw (#1638).

AF-assist lamp unit (#B326)

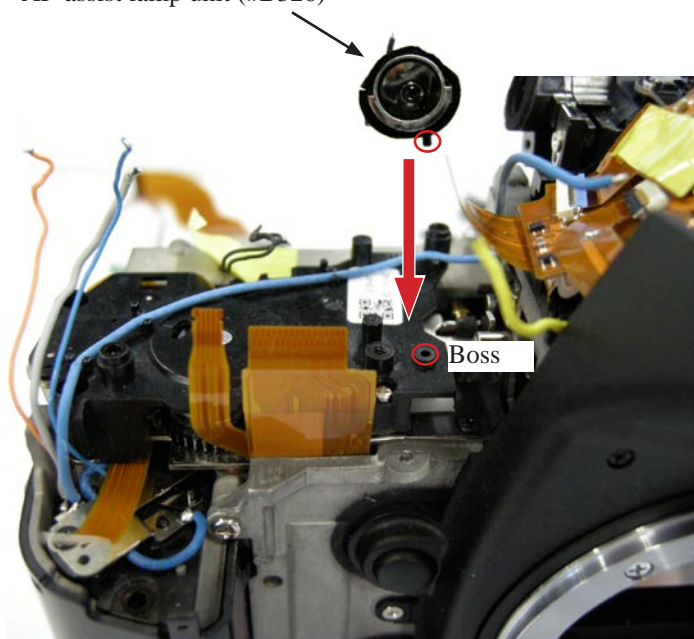

Screw (#1638)

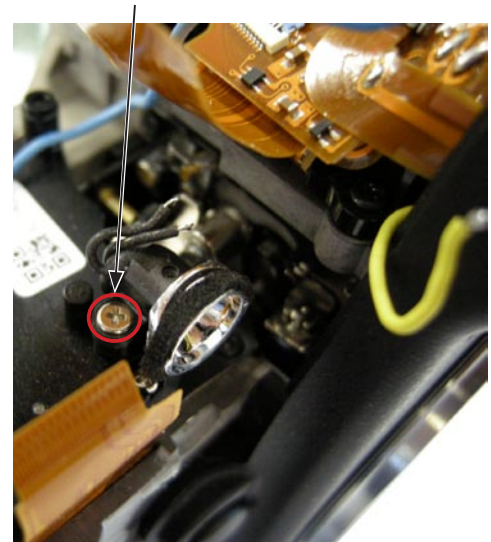

Main PCB

- Attach the lug plate (#775).

lug plate (#775)

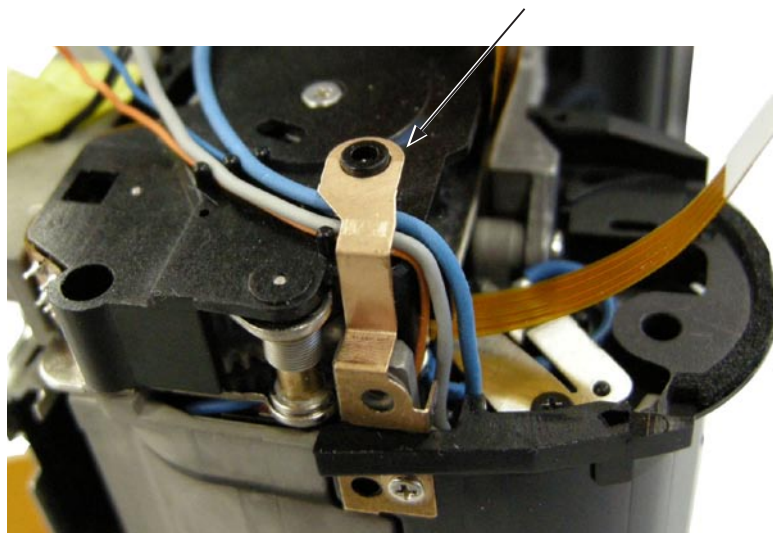

- Solder the wires ([Black][Red]).

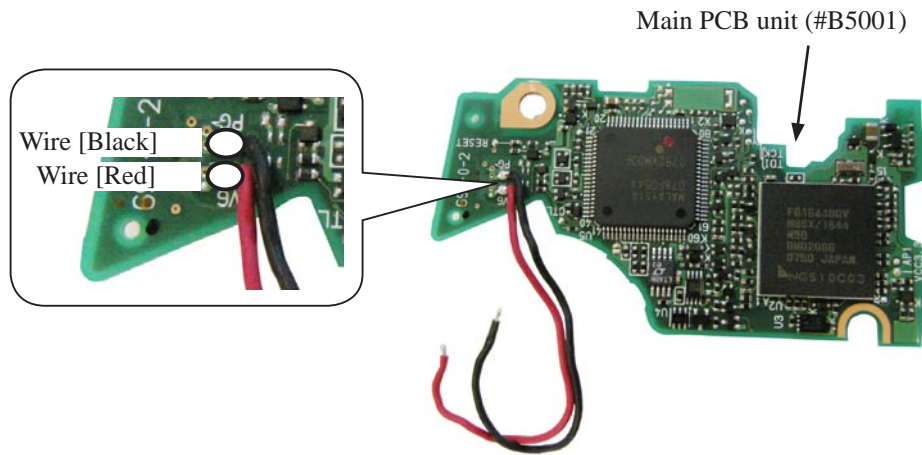

- Arrange the wires ([Black][Red]) as below.

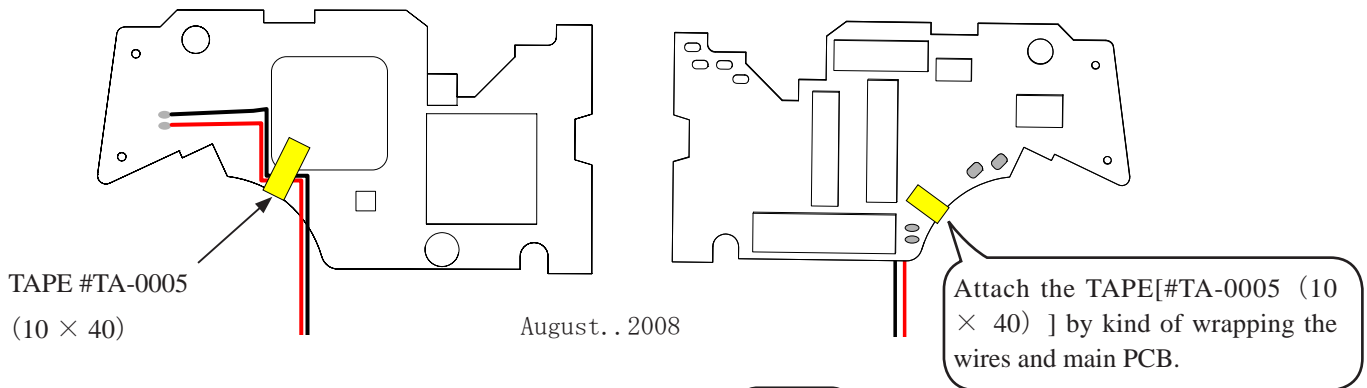

- Connect the connection-FPC (#5039) to the connector.

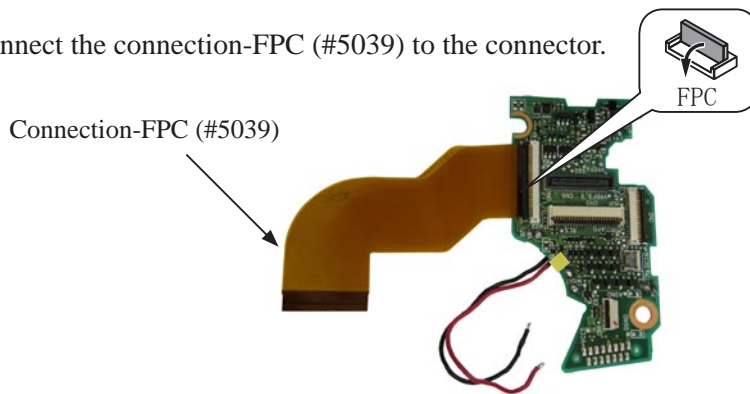

- Mount the main PCB unit (#B5001).

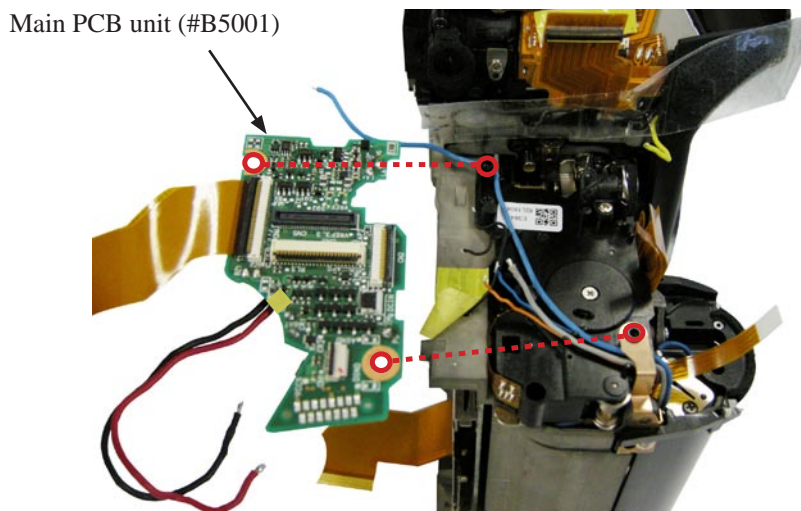

- Tighten the two screws (#1616) in numeric order (① → ②).

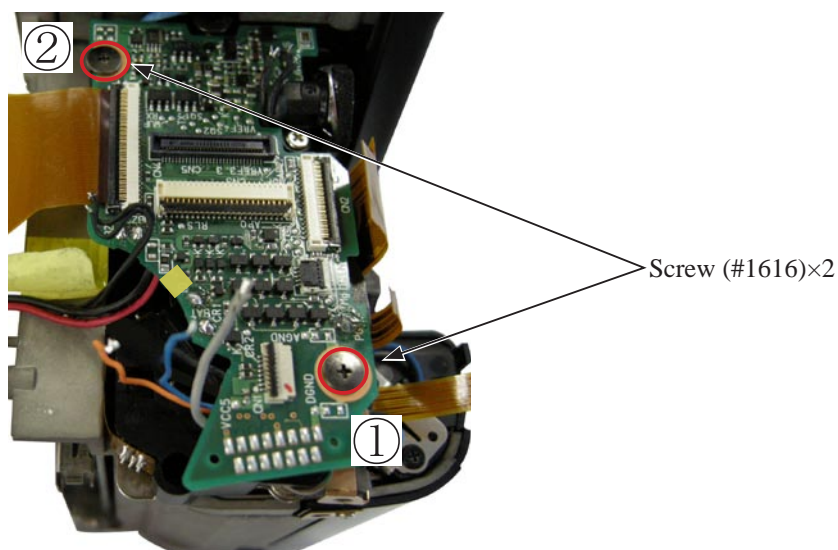

- Direct the wires of the piezoelectric buzzer (#5065) and AF-assist lamp unit (#B326) outwards.
- By wrapping the tape [#TA-0005 (10×20)], arrange the wire edge of the piezoelectric buzzer (#5065) and the black and red wires.

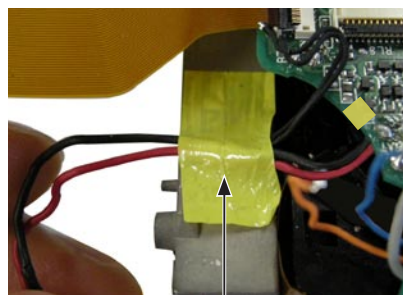
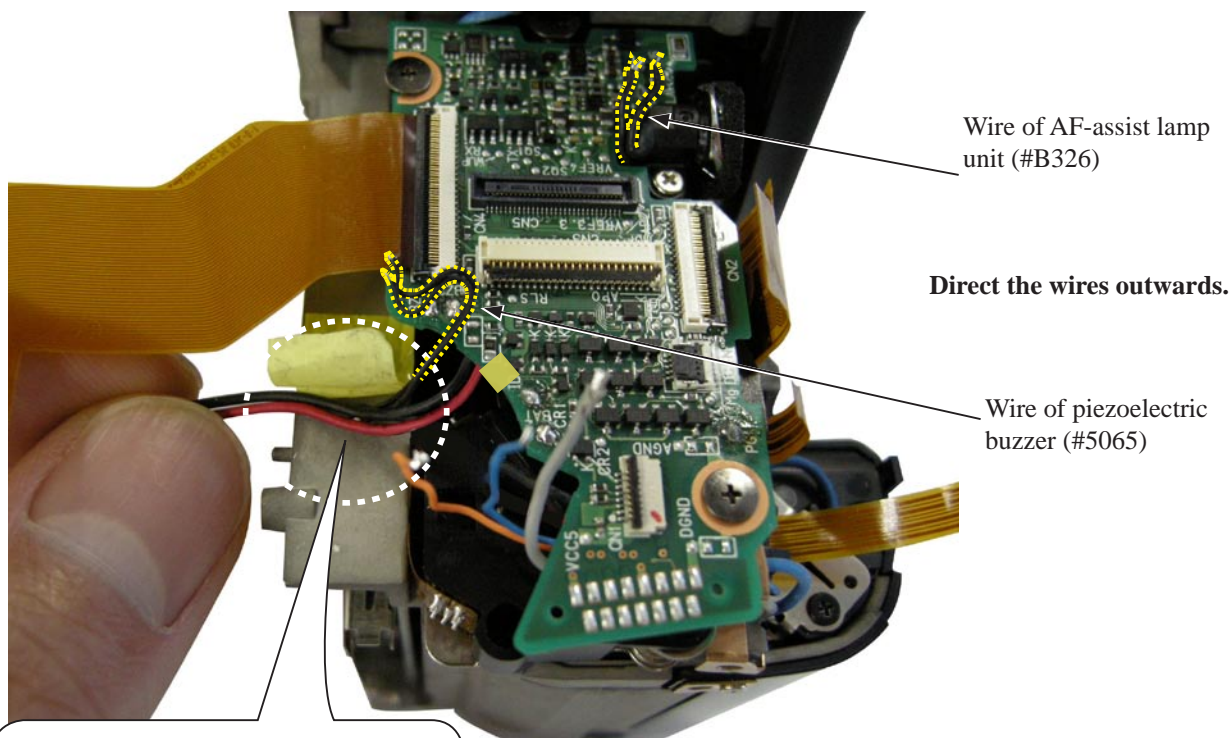

- Solder at eight places.
- Solder the FPC at three places.

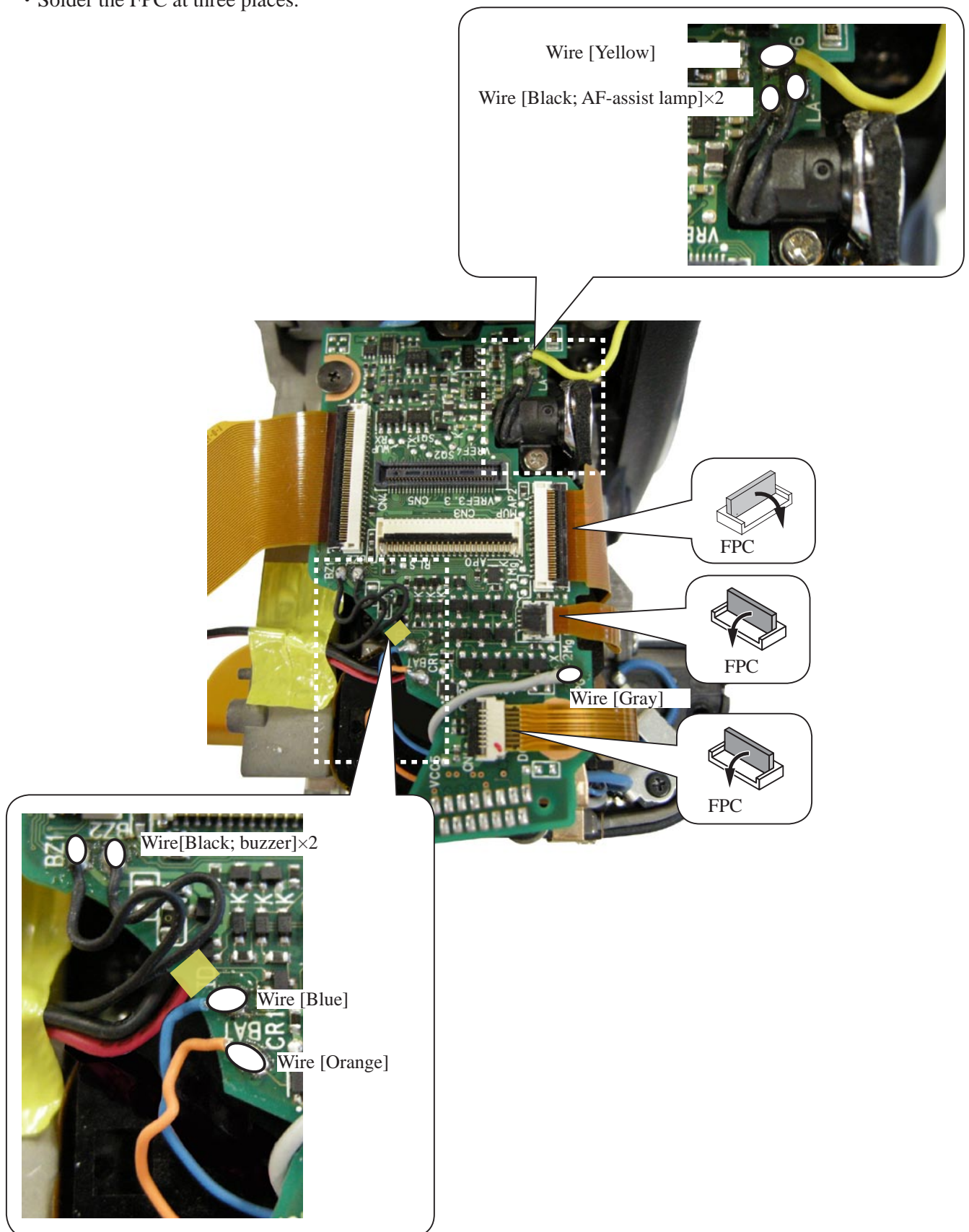

- Connect the penta FPC unit to the connector.
- Attach the tape [#TA-0005 (10×3.7)].

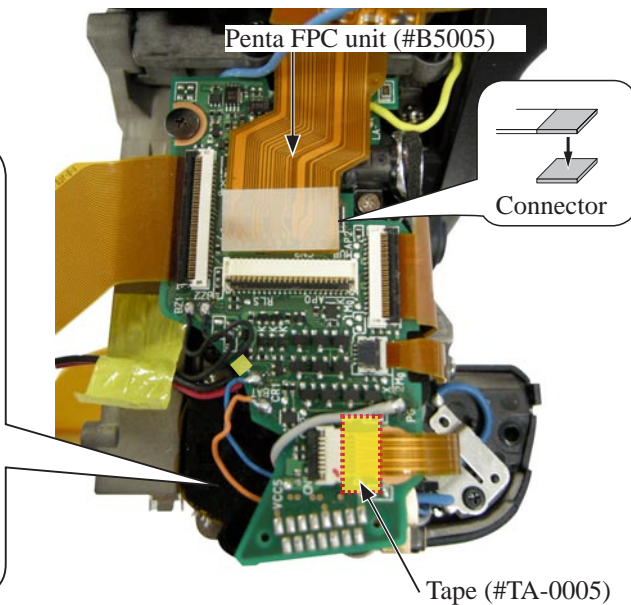
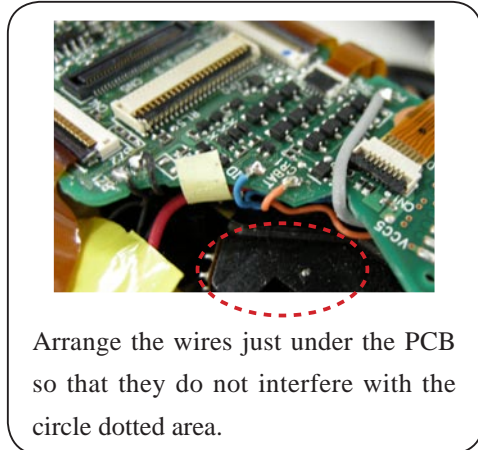

- Pass the wire [blue] of the battery contact unit (#B822) through the gap between the main PCB and the body.
- Solder the wire [Blue] of the battery contact unit (#B822) on the FPC.

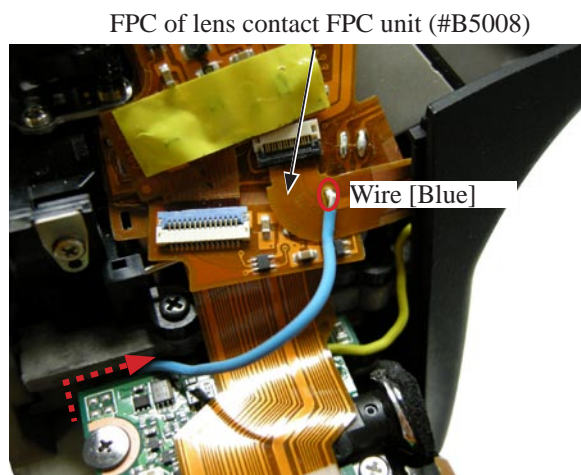

DC/DC PCB

- Attach the harness (#5071).
- Attach the harness (#5070).

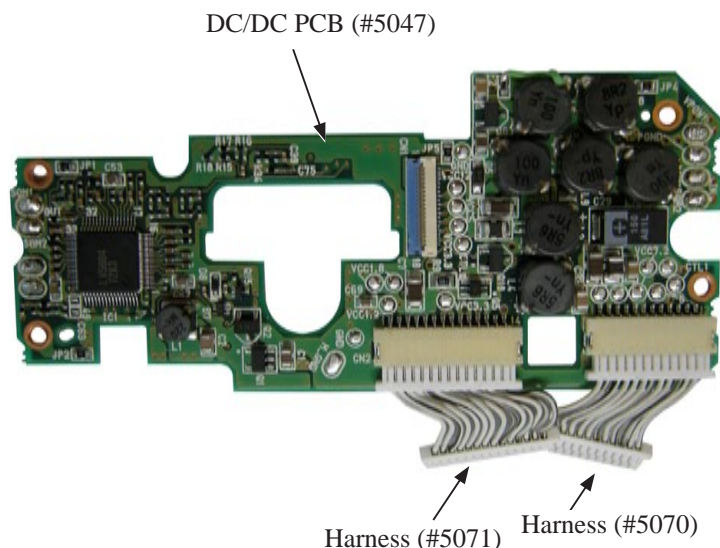

- Mount the DC/DC PCB (#5047).

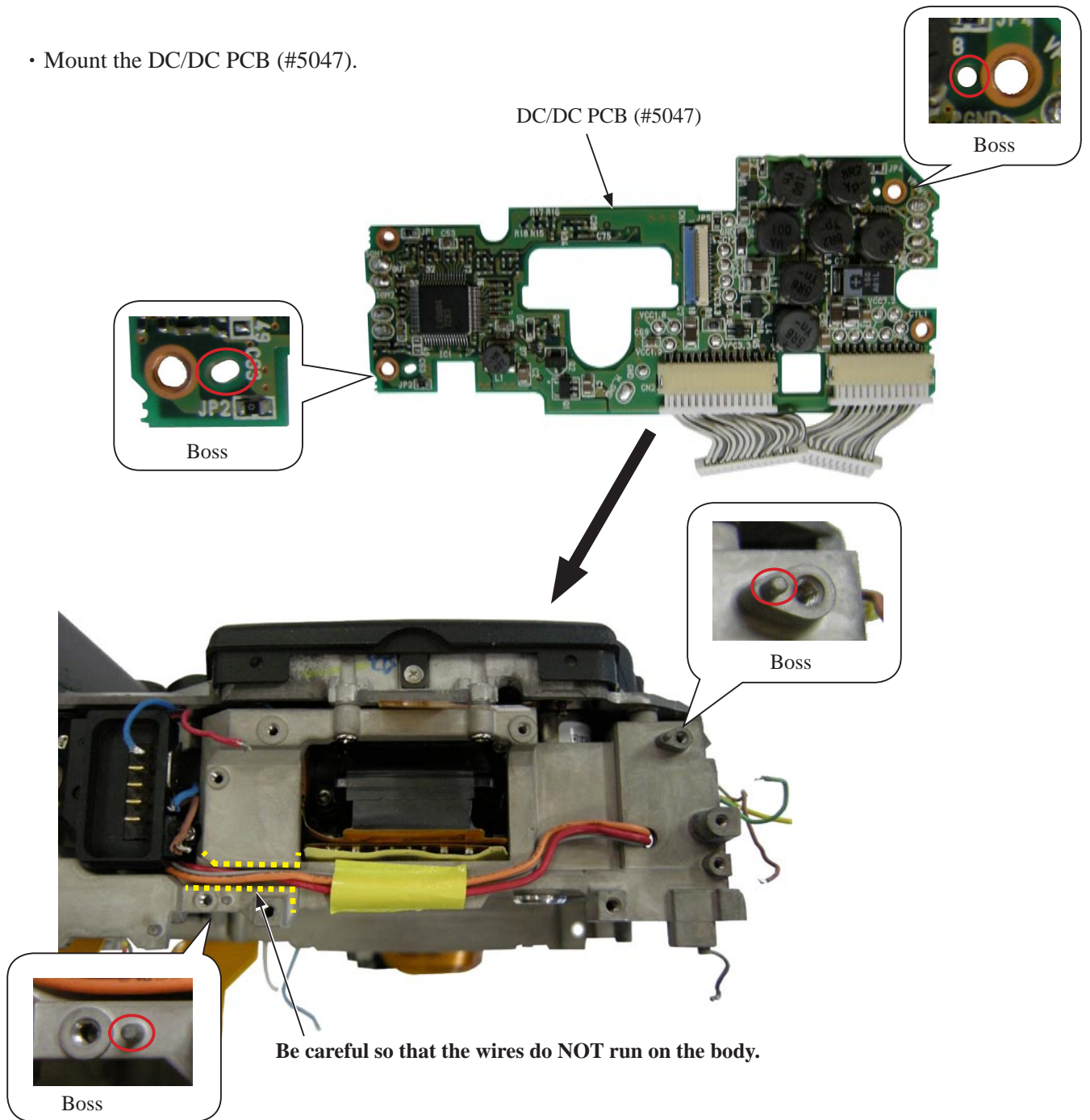

- Tighten the four screws (#1509) in numeric order (① → ② → ③ → ④).

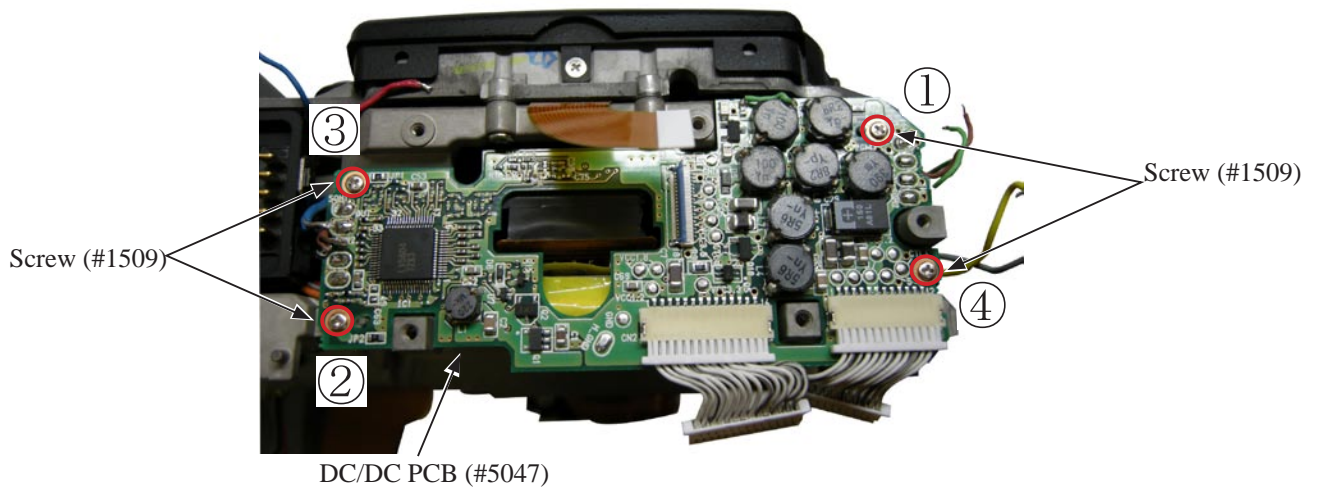

- Solder at eight places.
- Attach the FPC.

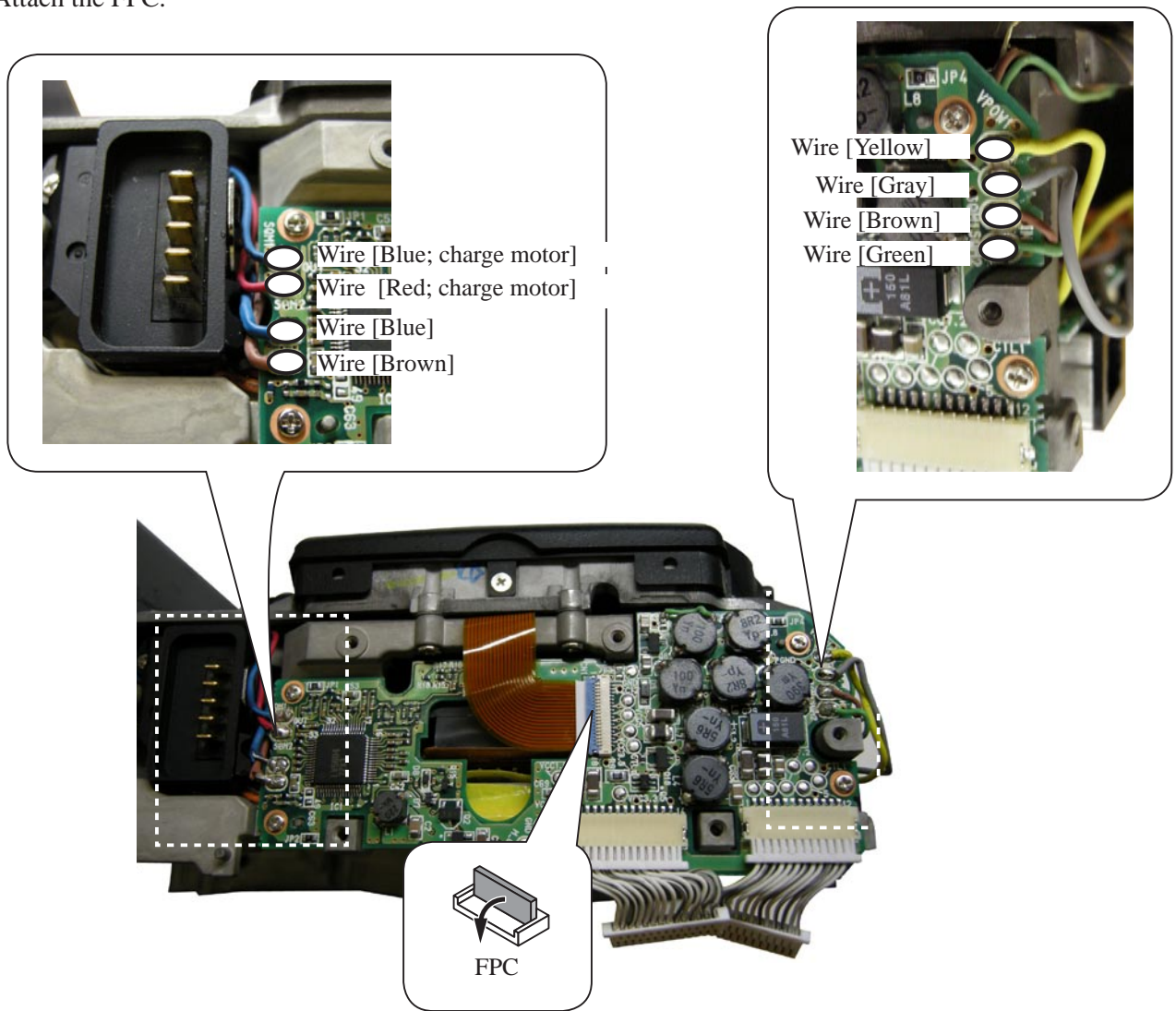

- Solder the wires ([Gray][Orange][Red]).

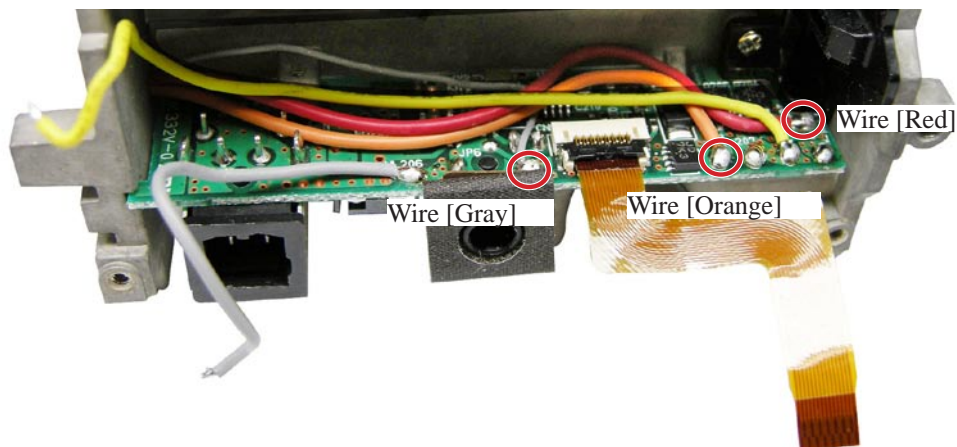

- By wrapping the tape [#TA-0005 (10×3.7)] arrange the wires ([Green][Brown]).

Be careful so that the tape (#TA-0005) does NOT cover dotted area.

Tape (#TA-0005)

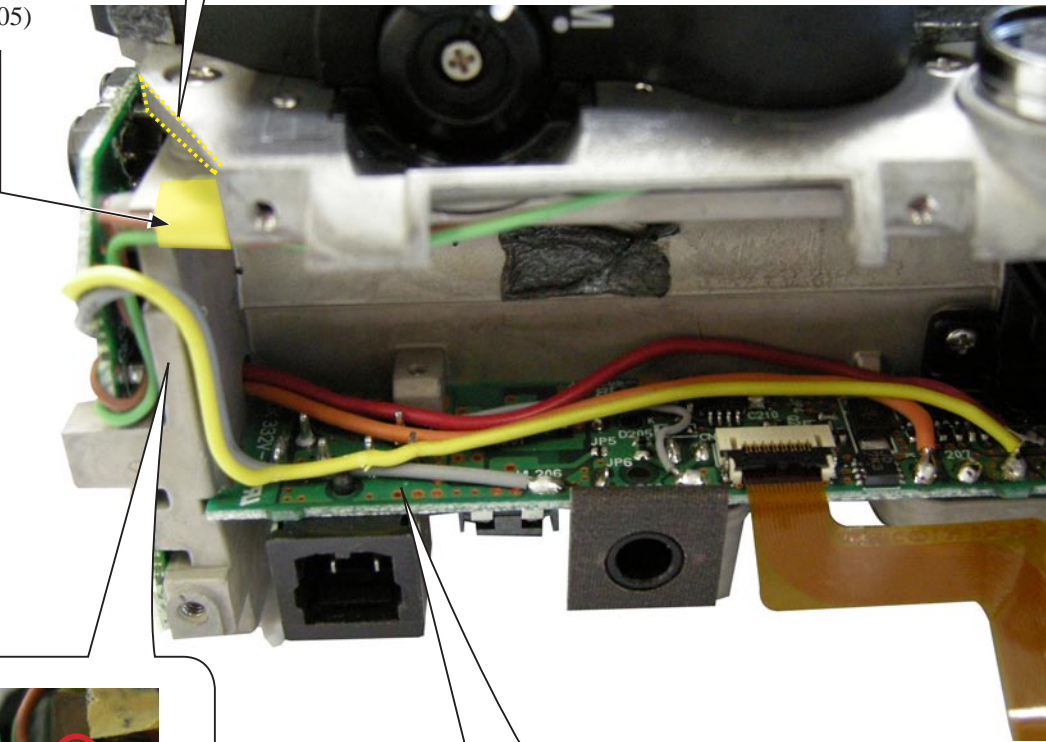

The wire must NOT run on the dotted area.

The wire must NOT cover the above protrusions.

Inspection and adjustment of AE CCD positioning

△ (Addition)

《RS232C or USB communication》

- * Under the environment where the AE-CCD positioning is adjusted, use the reference body and confirm results.
- In case the measured value is out of standard, check whether there is no deviation of the focus area positioning.
- In case the measured value is out of standard, change the environment of measurements. (e.g. setting place/direction, room brightness, etc)

Caution) Whenever the metering FP unit is disassembled/replaced or the main PCB is replaced, make this adjustment.

Procedure

- ① Make temporary assembly of the bottom cover, as the tripod is used.
- ② Mount "AF50/1.4D" on the camera, and fix them on the tripod horizontally.
- ③ ~~Connect the camera and PC via USB cable (UC-E4).~~ △ (Revision)
Connect the camera and PC via cable MC-31 (USB is available in case of inspection).
- ④ Connect the AC adapter EH-5.
* Be careful NOT to cause a short-circuit at uncovered portions.
- ⑤ Attach the AE-CCD positioning tool (J63097) in the color viewer (J63070), and turn power ON.
- ⑥ Keep the 0.7-m distance between the front face of the AE-CCD positioning tool and the reference surface of the camera. Set the camera AF to manual, and rotate the focus ring to set to "0.7 m".
- ⑦ Start up the inspection and adjustment software for D700 (J65119), and select "Inspection and Adjustment for AE CCD POSITION" then "Set Camera for AE CCD POSITION" to lighten the focus area.
Looking through the viewfinder, move the camera so that the focus area of the camera coincide with the grid lines of the AE-CCD positioning tool.
* Set the camera and AE-CCD positioning tool horizontally.
- ⑧ Select "Inspection and Adjustment for AE CCD POSITION".
* Cover the camera with a black cloth, etc, when measured.
- ⑨ By following the instructions on PC, adjust the AE-CCD position by using the screw (a and b).
- ⑩ After confirming the tilt is within standard, fix the three screws with the screwlock.

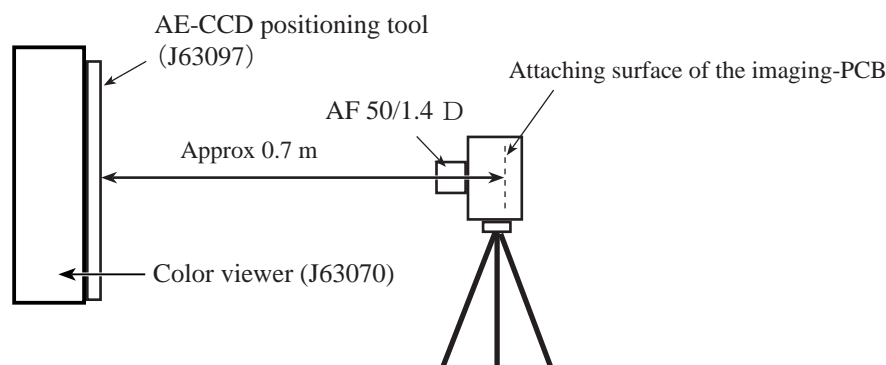

Device

 COLOR VIEWER	J63070	 AF50 / 1.4D LENS AF50/1.4D	J18266	 AE/CCD USE CHART BOARD FOR D3	J63097
------------------	--------	-----------------------------------	--------	-----------------------------------	--------



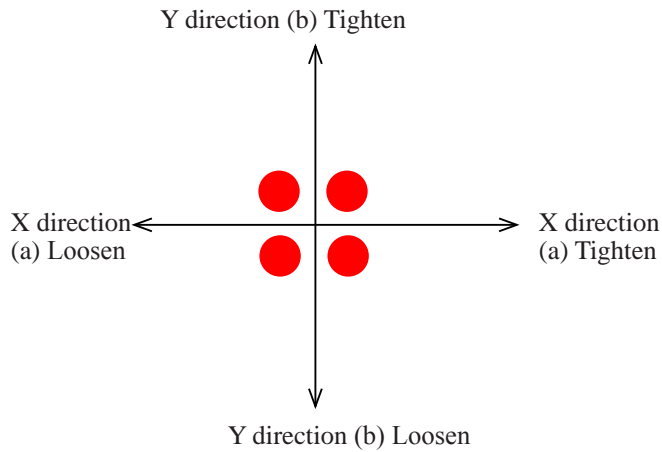

Reference → Reference screw

X direction → a: screw

Y direction → b: screw

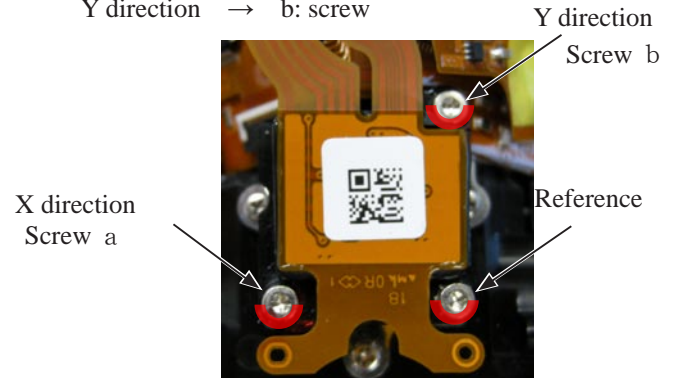

- Because the screw ① is the reference screw, do NOT rotate it for adjustments unless absolutely necessary.

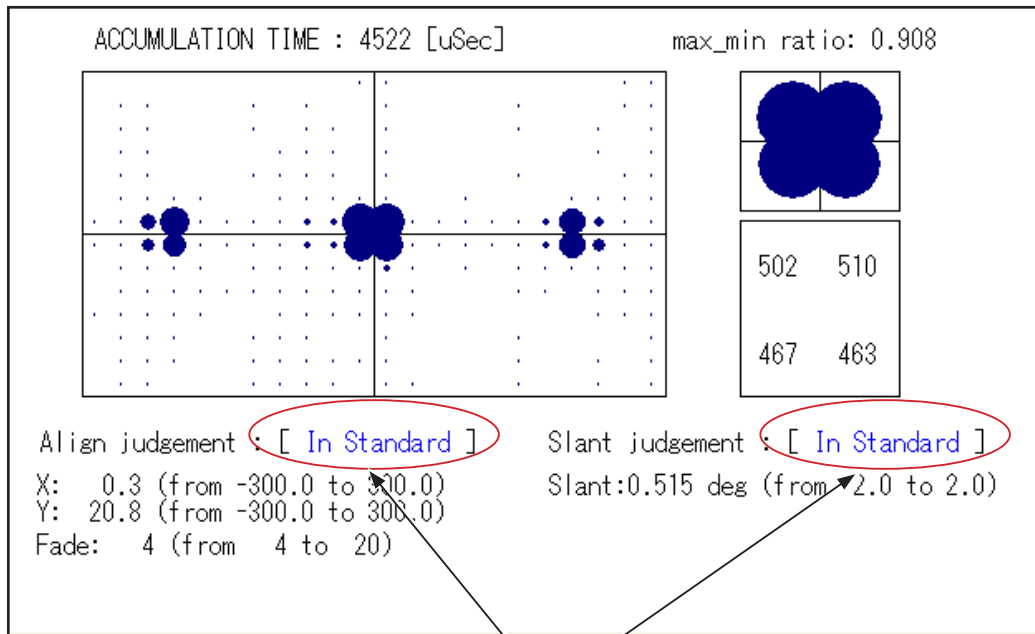

Must be within standard

6. Top cover

Top cover external parts

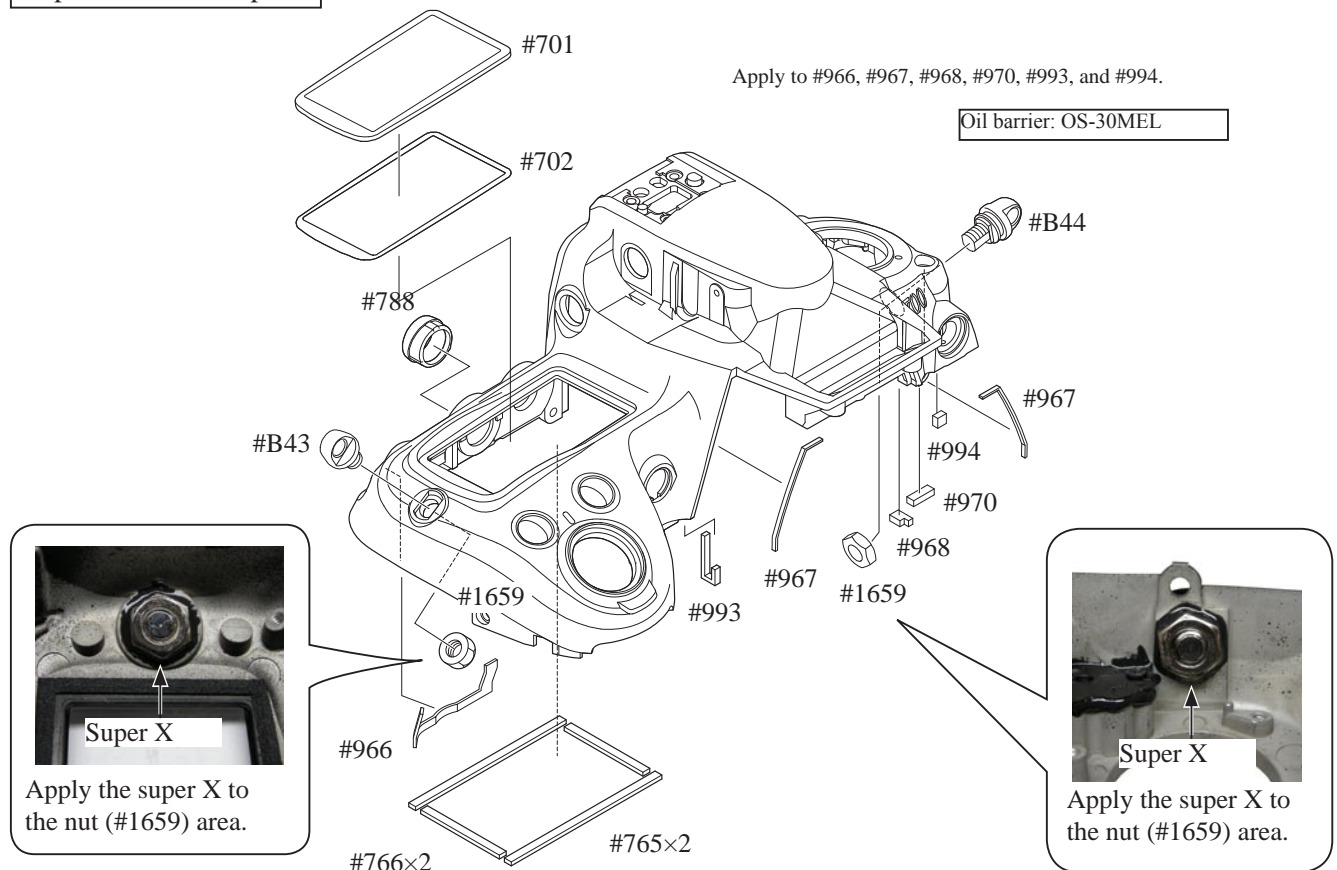

- Mount the AF-assist lamp protector (#327), and apply the super X.
- Attach the Tape (#709).

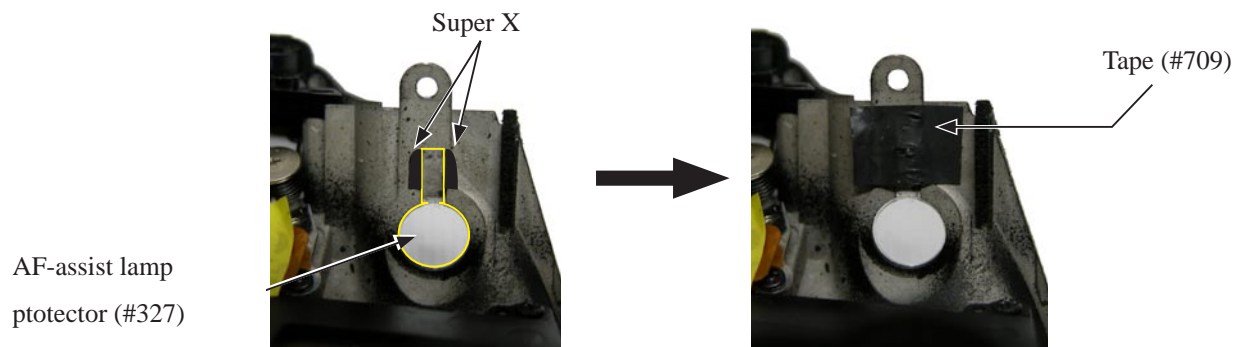

- Attach the Tape (#972).

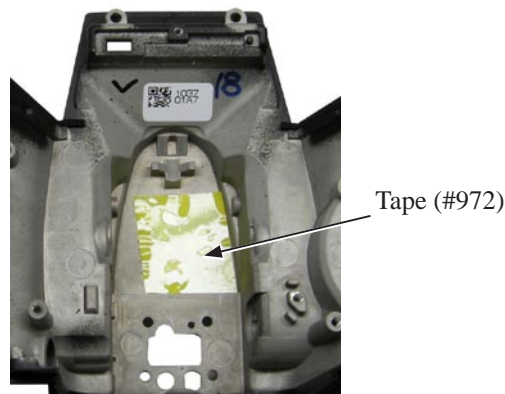

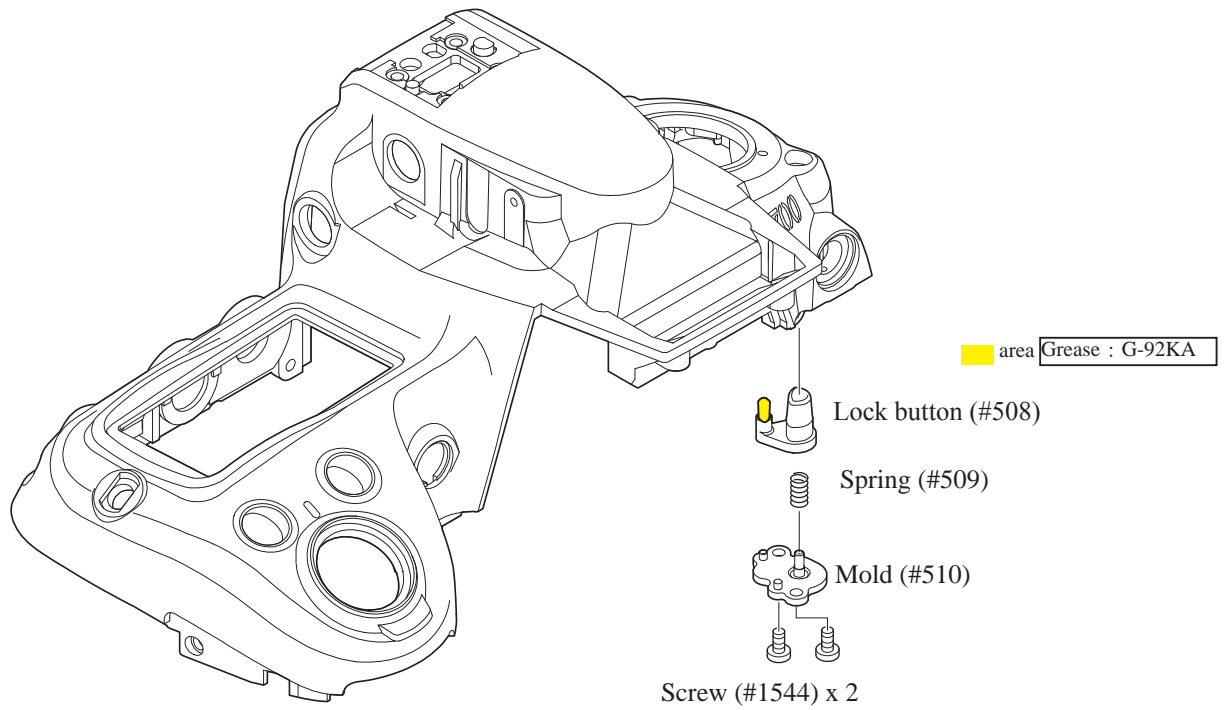

- Apply the super X to around the mold (#510).

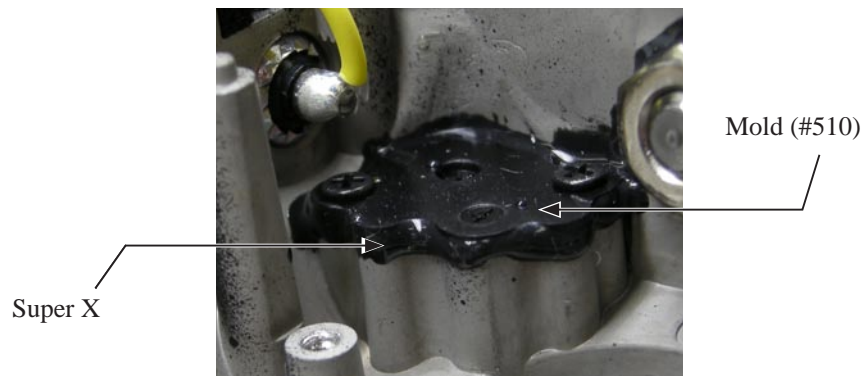

- Attach the synchro-terminal (#50), and tighten the screw (#1532).

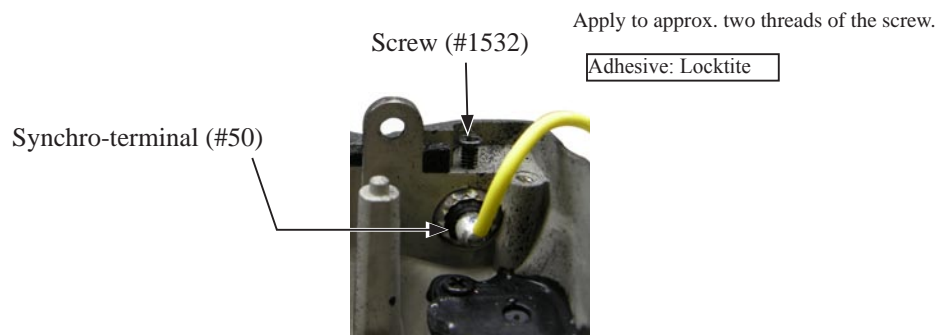

- Attach the playback/DEL button (#513) by fitting with the ribs.

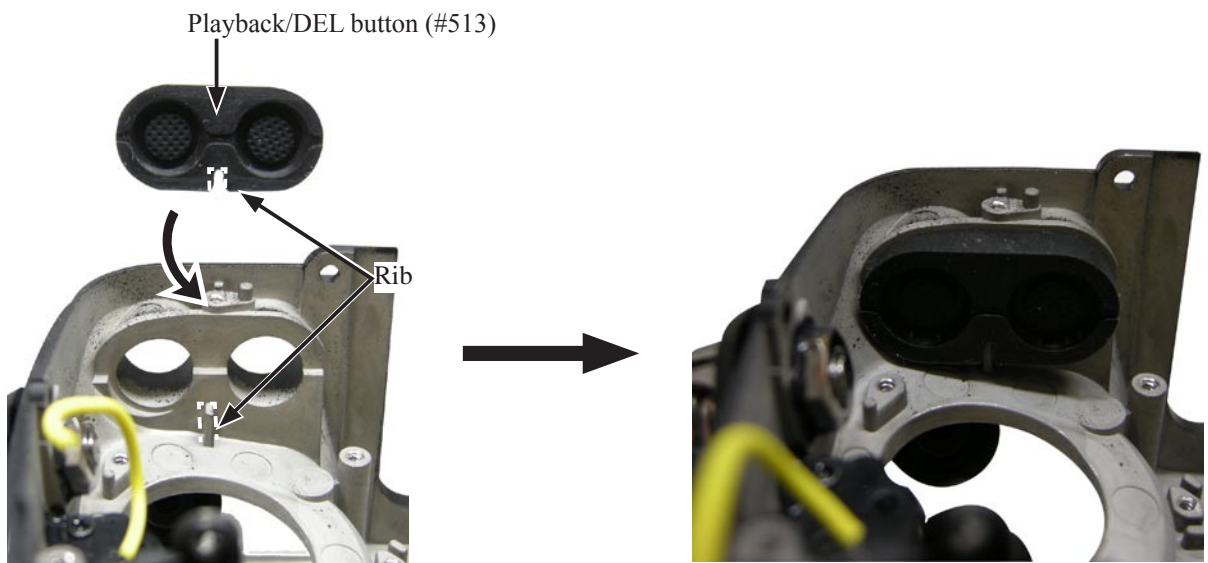

Mode dial

- Attach the base plate (#505), and tighten the screw (#1571) and two screws (#1609).

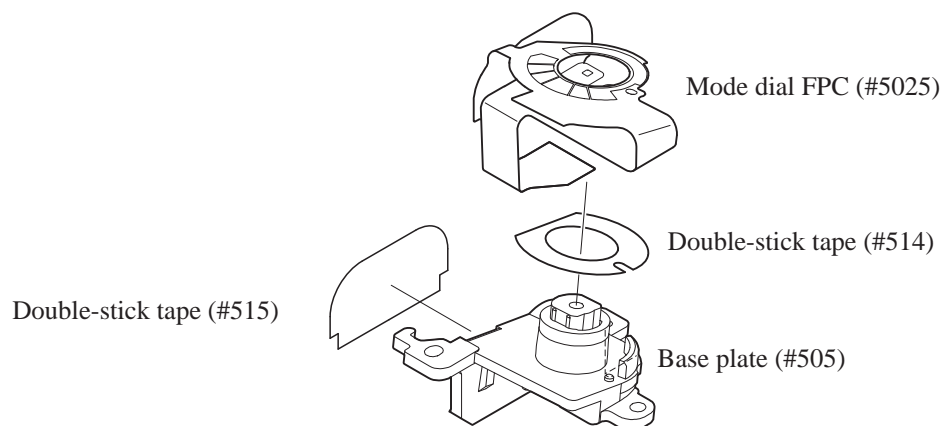
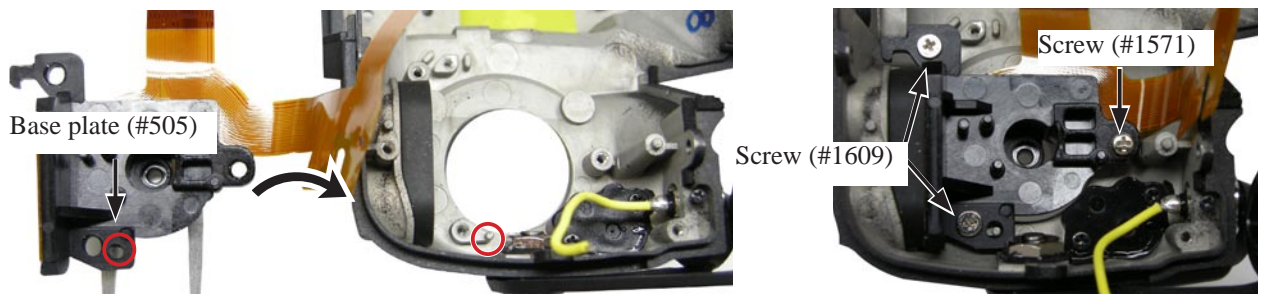

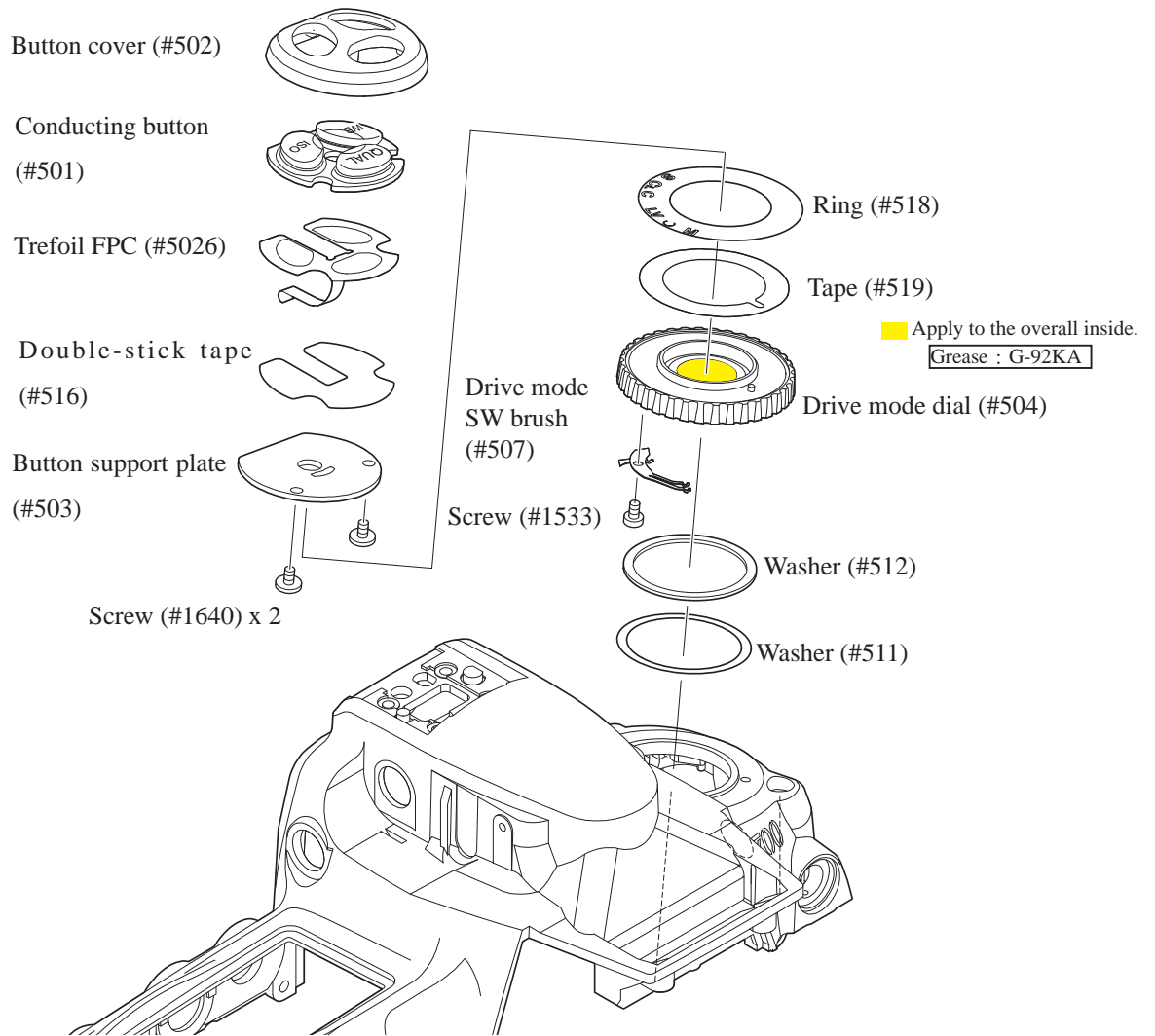

• Pass the FPC of the trefoil button unit through the hole of the mode dial base plate (#505), and tighten the screw (#1574) from behind.

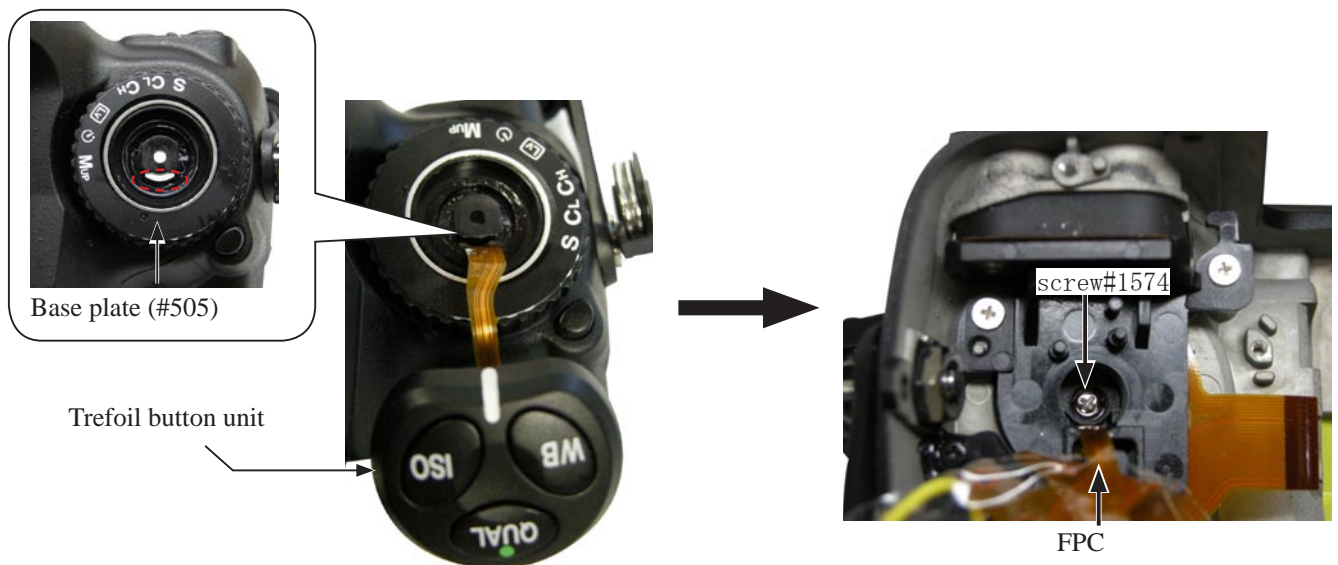

- Solder the mode dial FPC (#5025) and trefoil FPC (#5026).

Be careful of the overlapped position.

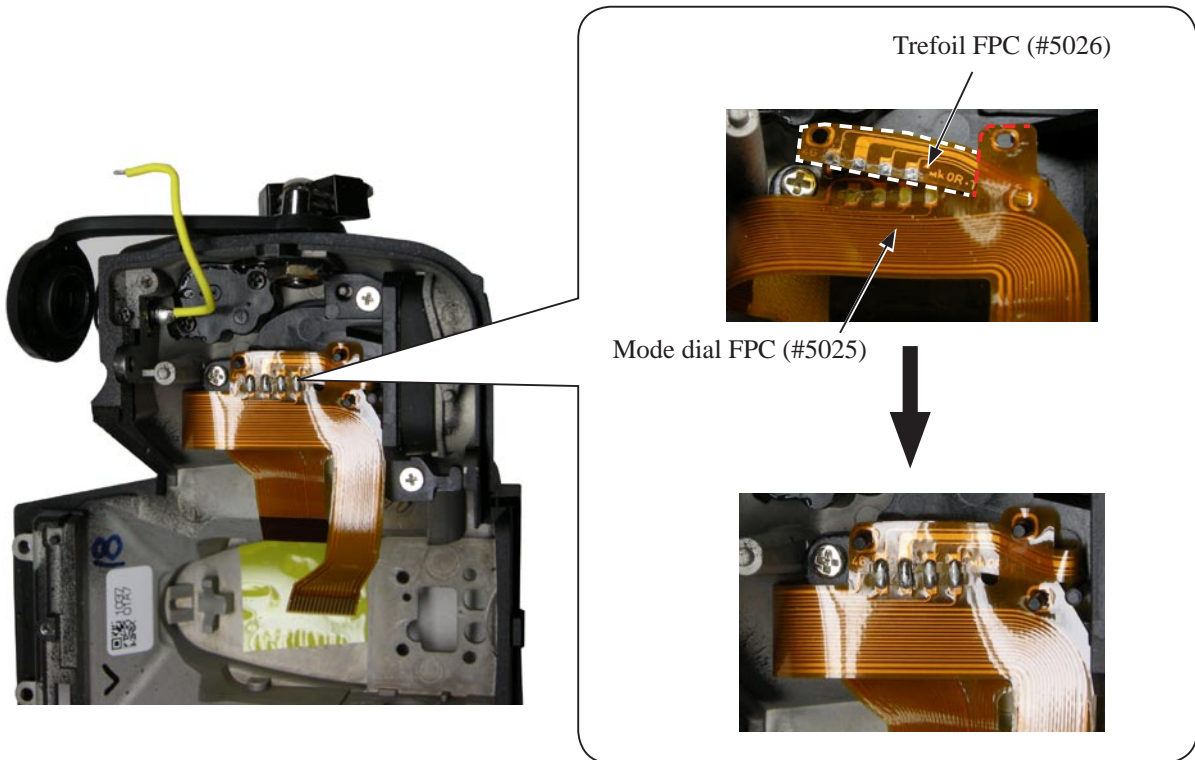

- Mount the SB Lock lever (#309).
- Attach the spring (#310), (using caution to avoid popping out of it.)
- Mount the retainer plate (#312) from upper side.
- Tighten the screw (#1565).

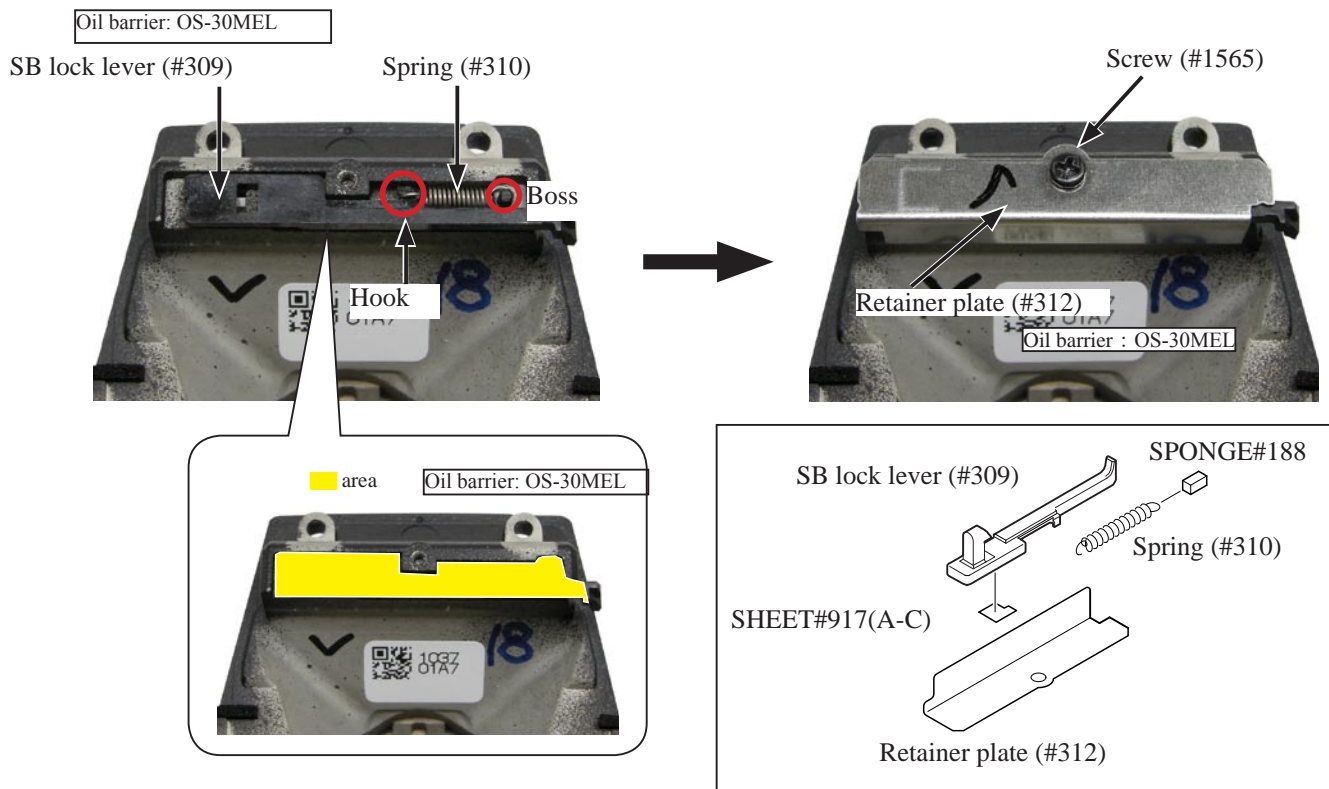

Main SW

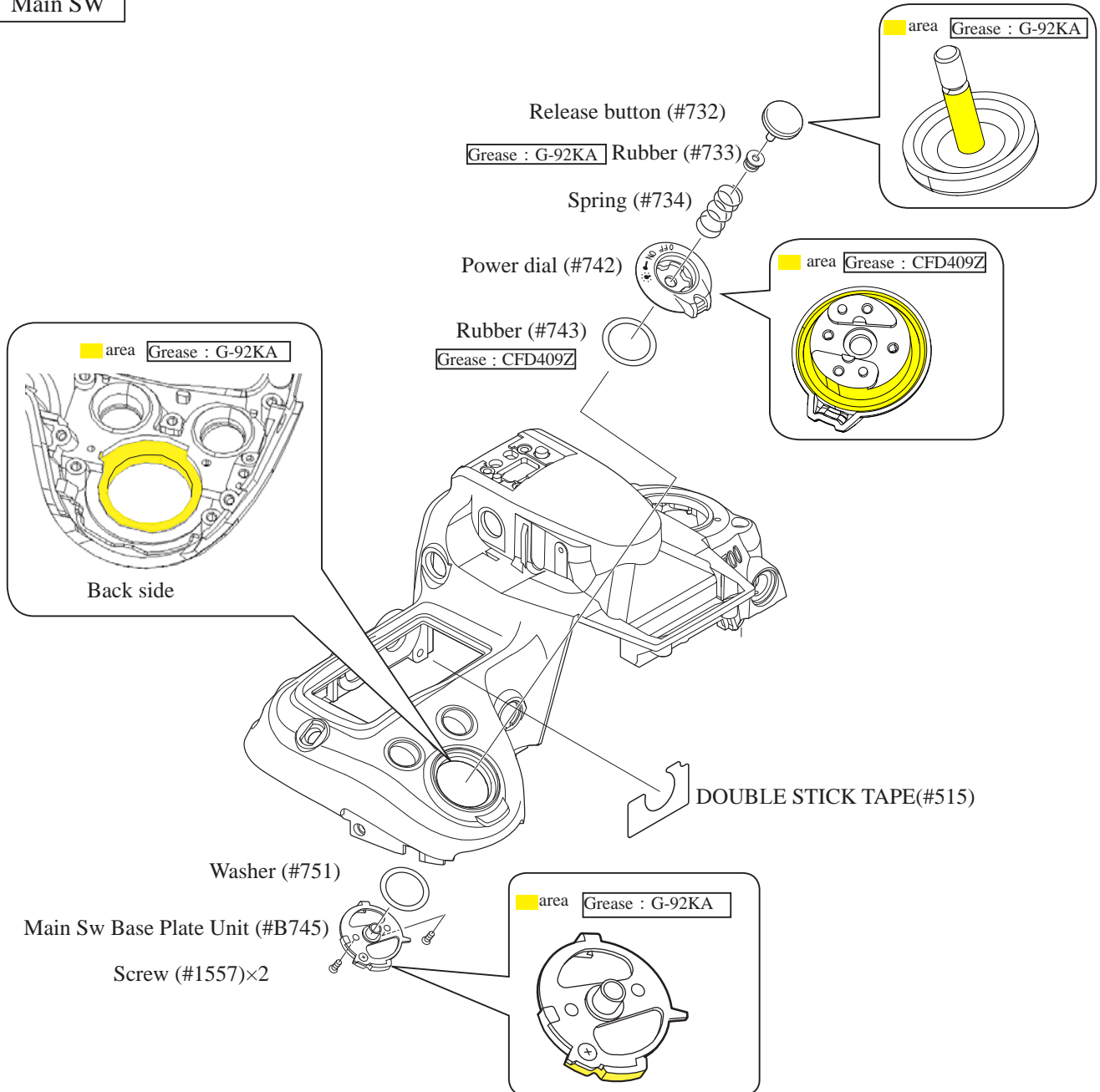

- By putting the washer (#744) from rear side, as if pinching the E-ring (#1652).

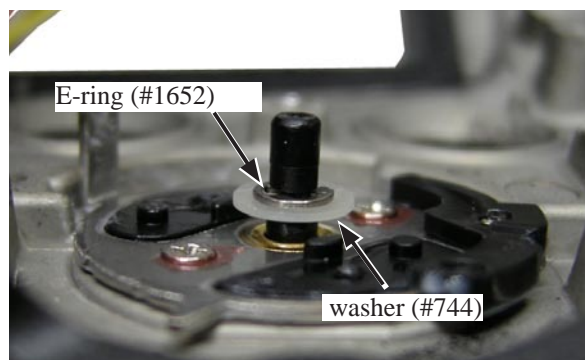

- Attach the two ON-OFF SW brushes (#748) by fitting with the boss, and tighten the screw (#1608).

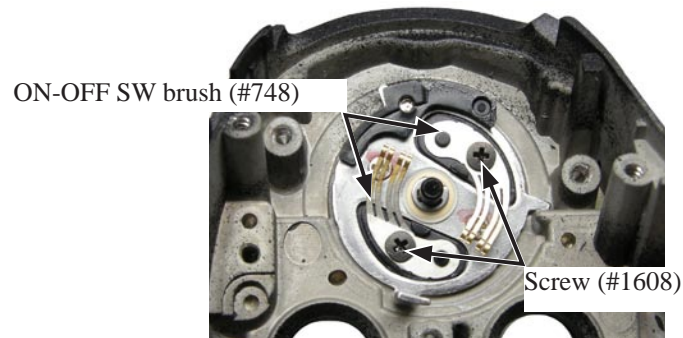

- Attach the metering mode FPC (#5028) by fitting with the protruded portion.

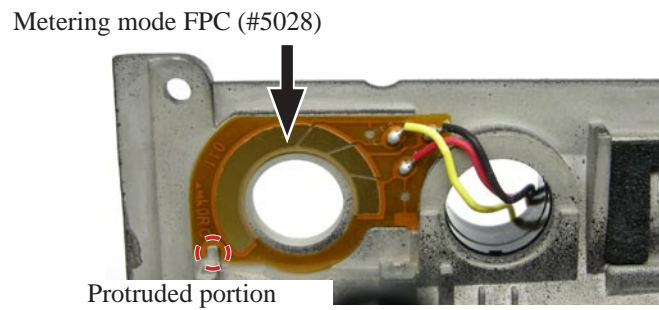

- Mount the AE mode dial (#781) and AE-Lock button (#780) as below.

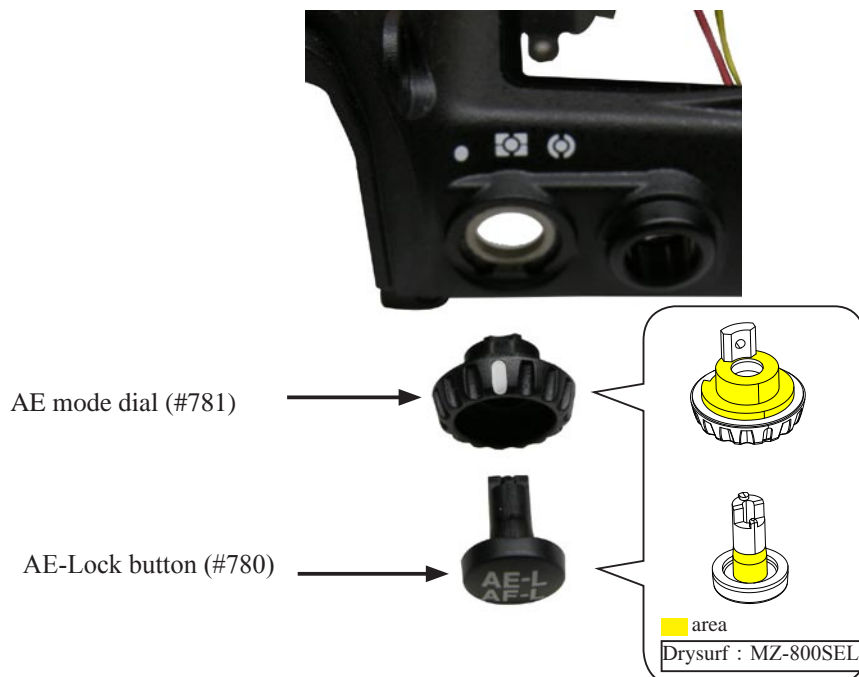

- Mount the metering mode dial unit (inside) (#B782) by fitting the screw hole of the AE mode dial (#781).
- Attach the spring (#784) by fitting with the bosses. (Use care to avoid popping out of it.)
- Tighten the screw (#1648).

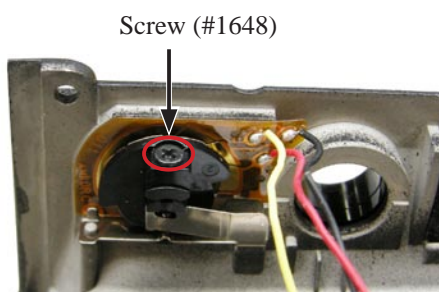
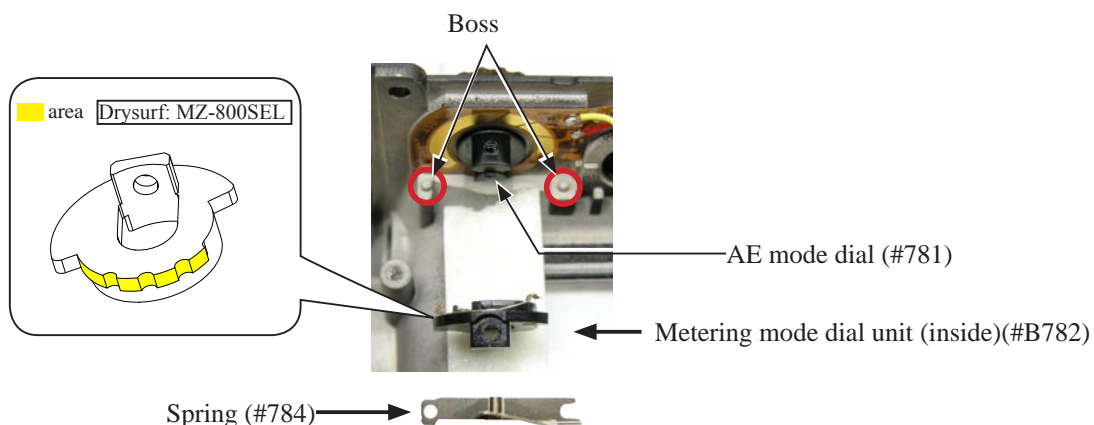

- Apply the super X to the below area, and attach the conducting button (#730).

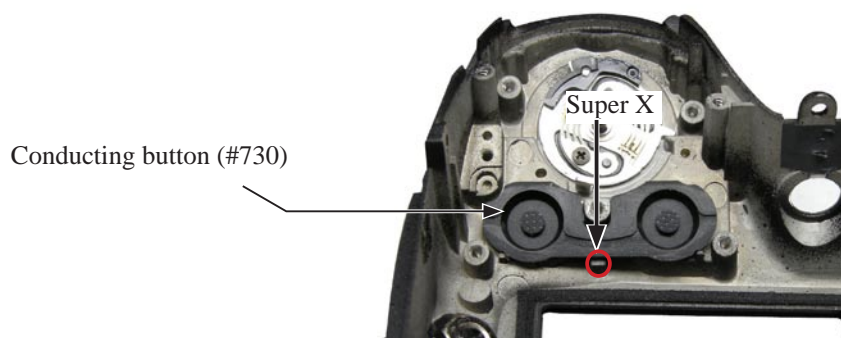

- Attach the conducting button (#787) from the rear side by fitting with the rib.

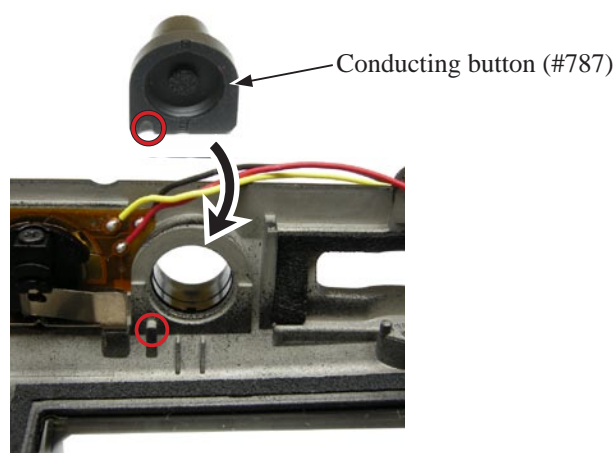

Top cover FPC unit

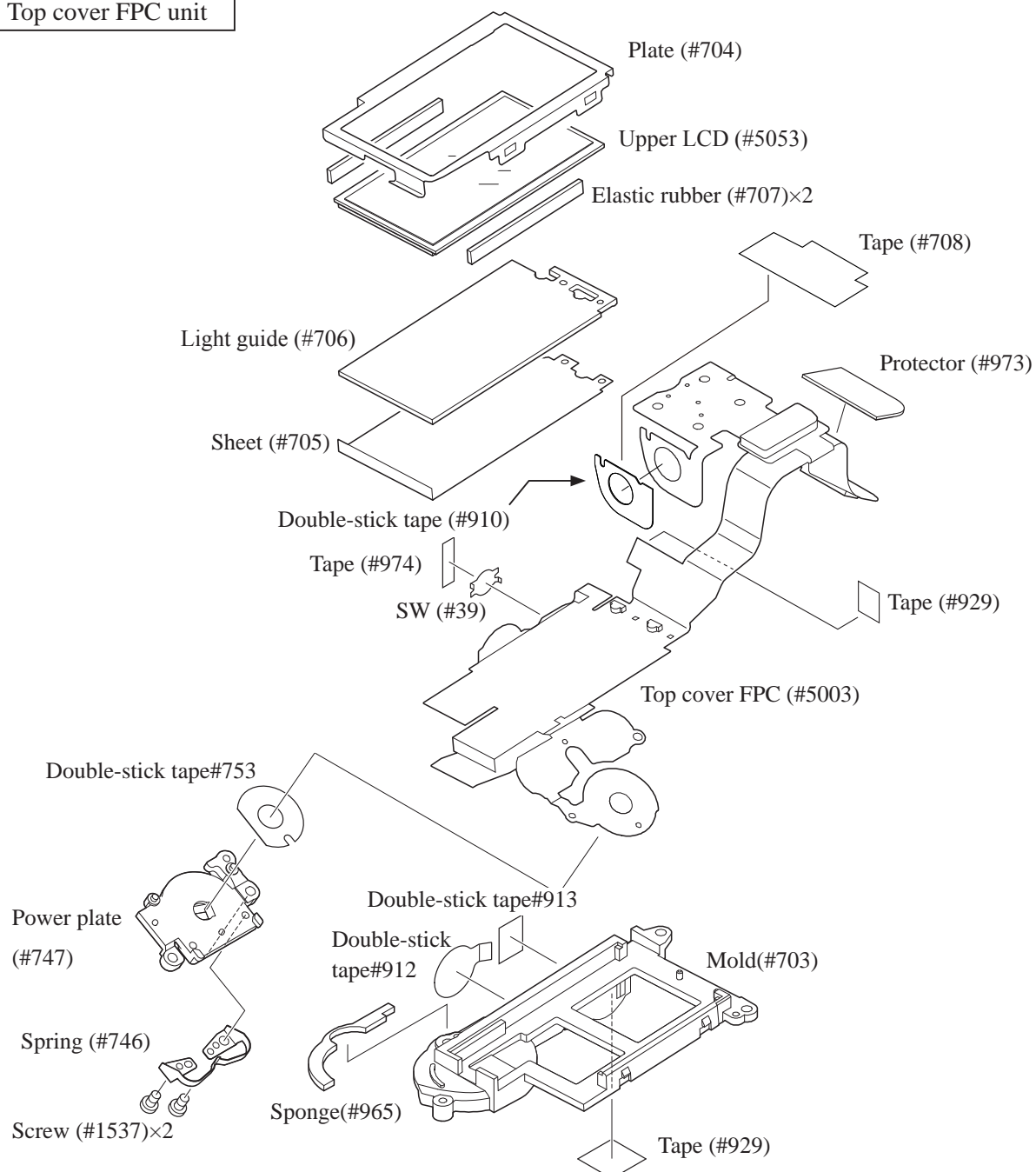

• Mount the top cover FPC (#5003).

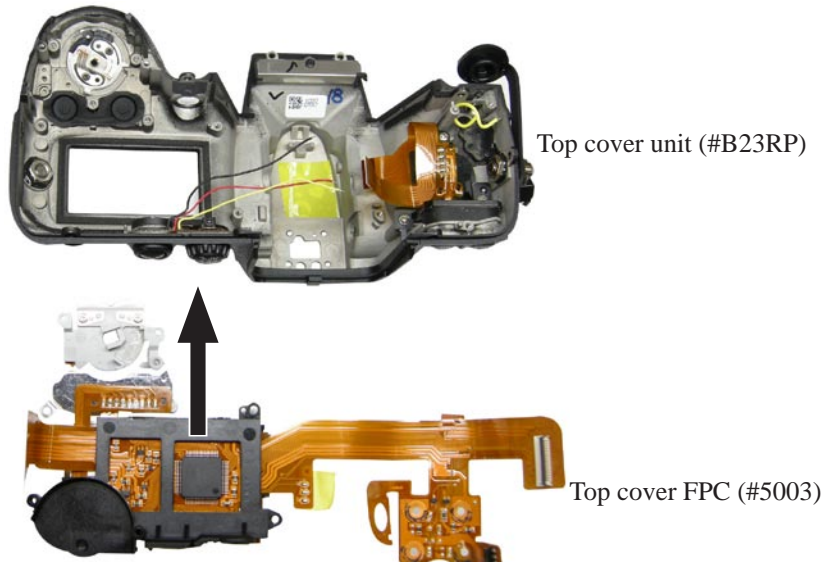

- Tighten the three screws (#1544) in numeric order (① → ② → ③).
- Tighten the screw (#1549) in numeric order (④ → ⑤).

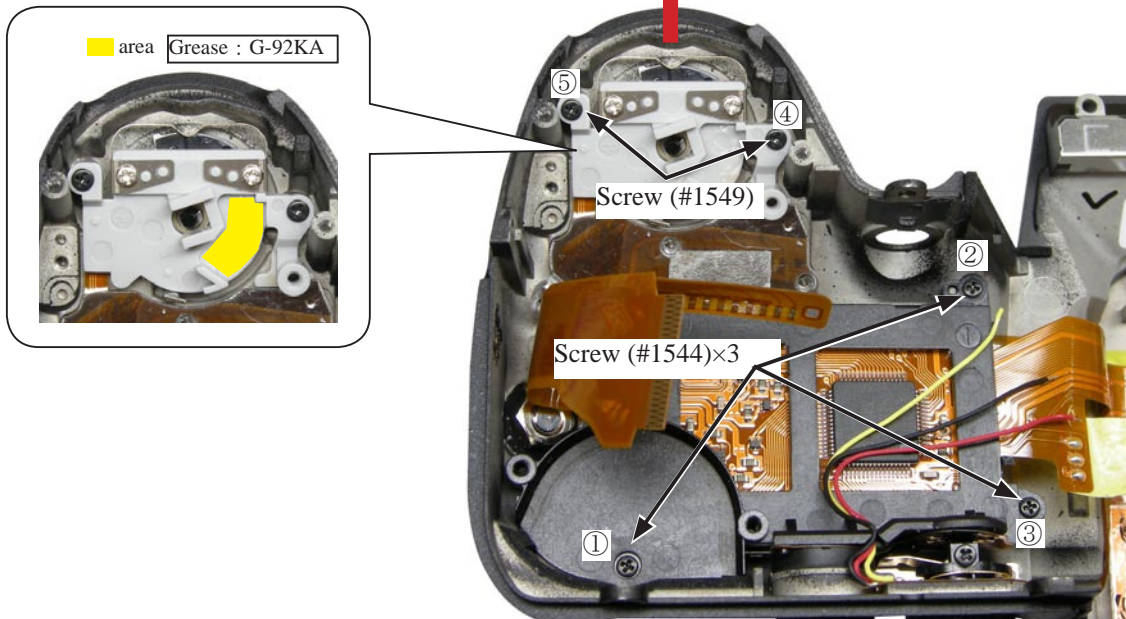

- Tighten the screw (#1560).
- Tighten the two screws (#1540) in the order from ① to ② .

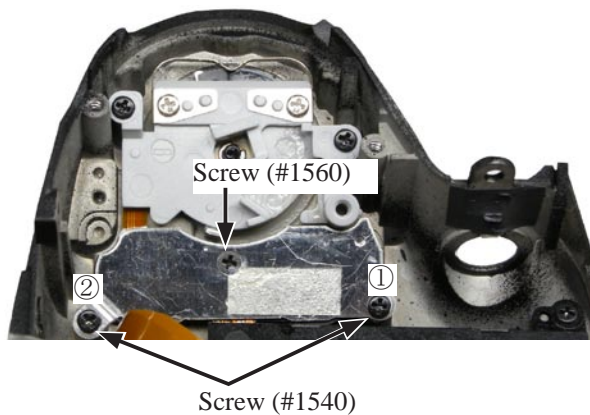

DOUBLE STICK TAPE (#911)

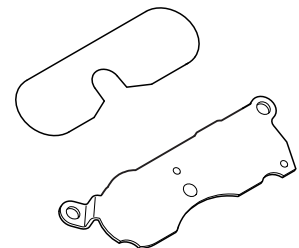

SUPPORT PLATE (#731)

- Attach the top cover FPC (#5003) to the support plate (#731).
- Attach the spring (#750), and tighten the screw (#1606).

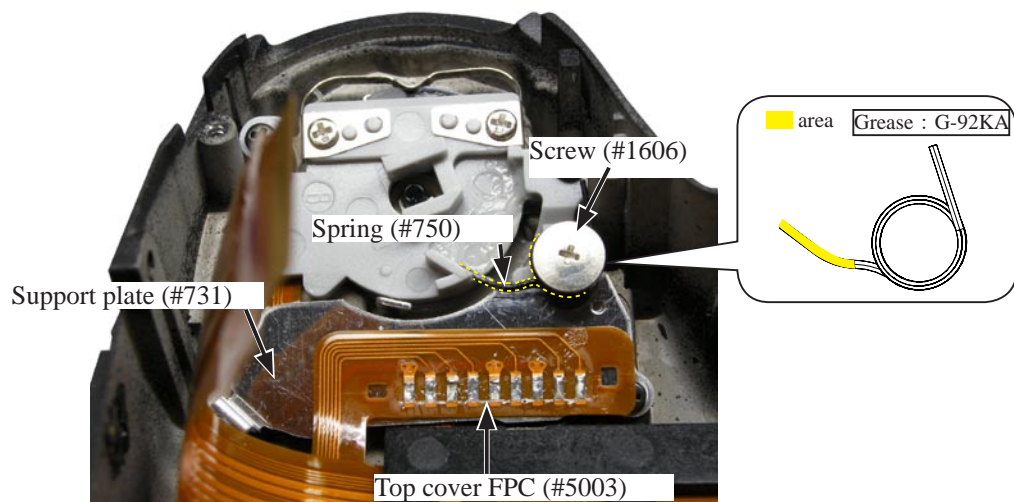

- Attach the top cover FPC (#5003) by fitting with the protrusion.

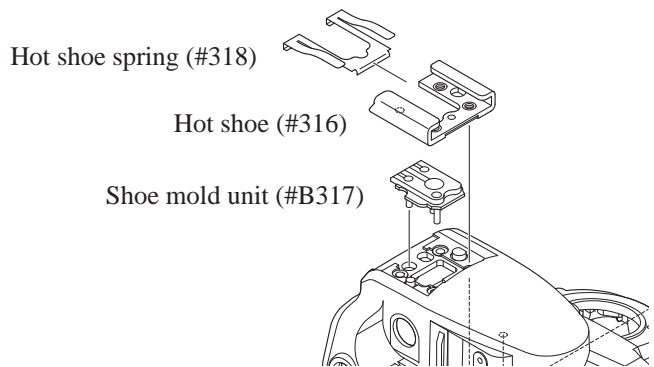
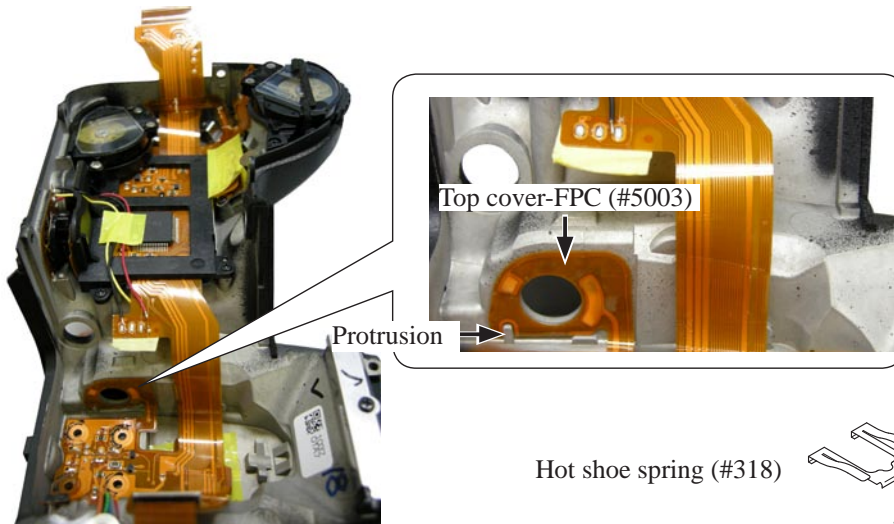

- Tighten the four screws (#321) in numeric order.
- Solder at four places.
- Apply the super X to the four screws (#321).

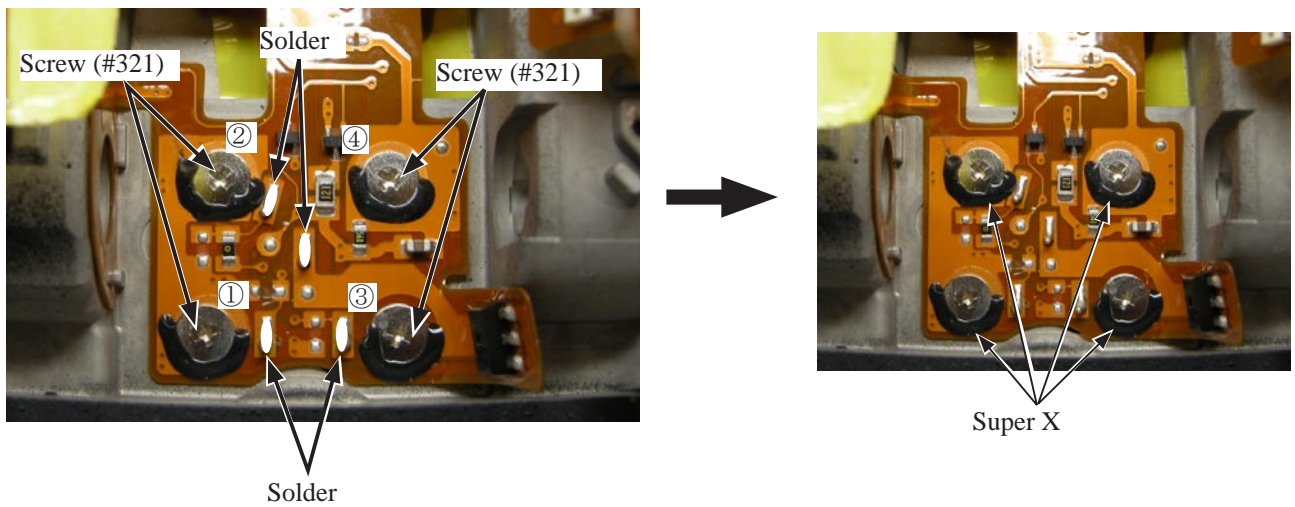

- Connect the FPC to the connector.

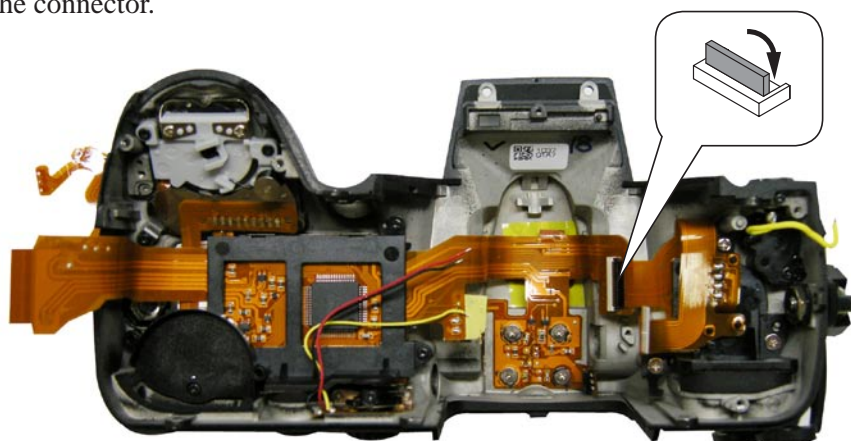

SB

Apply to the surface and inside.

Grease : CFD409Z

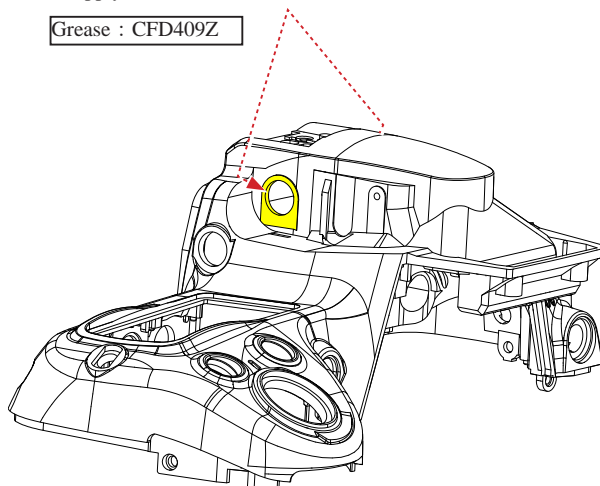

- Attach the collar (#307). (Confirm from the rear side that it is NOT caught on the FPC.)
- Mount the SB lower case unit (#B302).
- Attach the collar (#308) from inside.

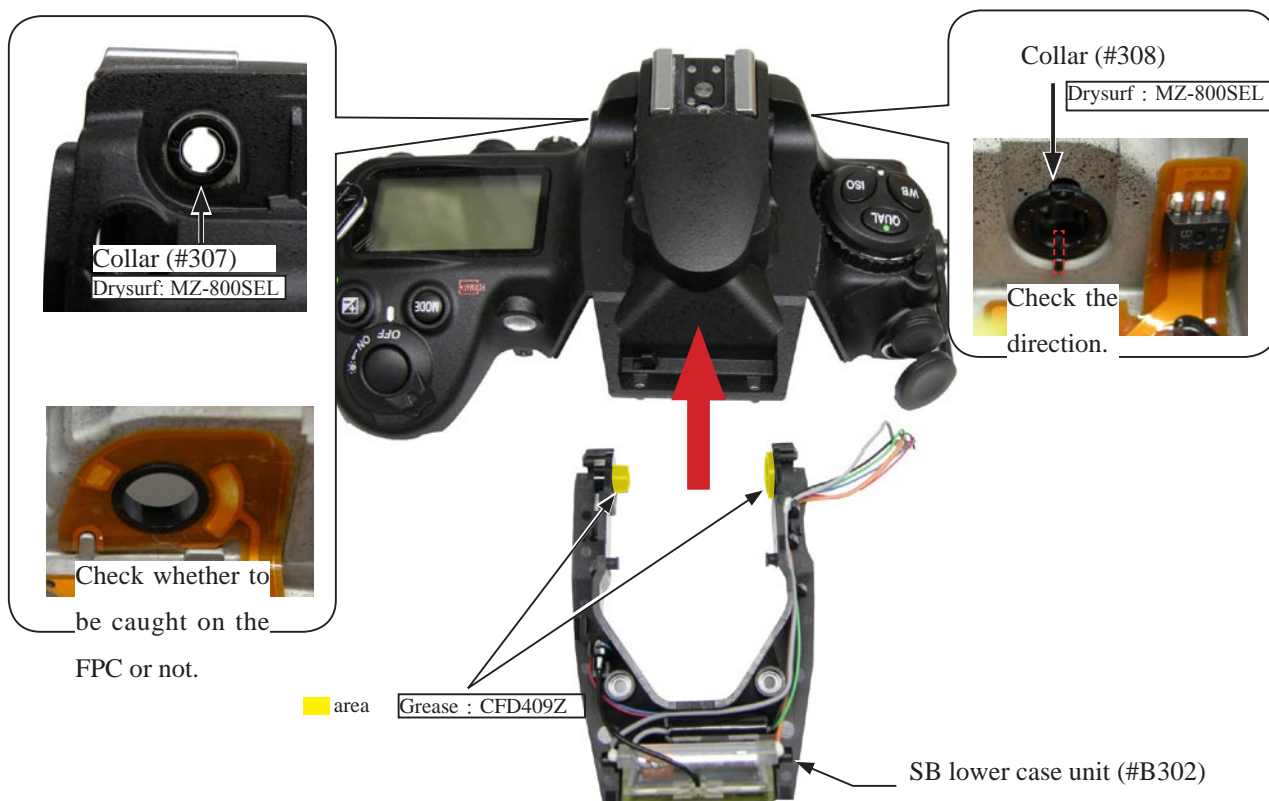

- Attach the collar (#B306) from inside. (Be careful of the bending of the brush.)

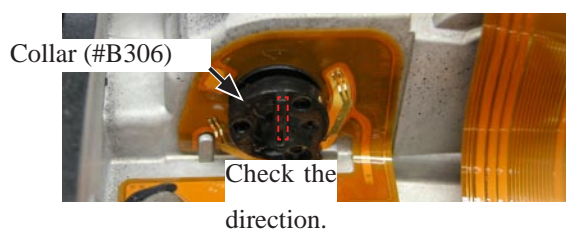

- Attach the spring (#305), and tighten the screw (#1601). (Use caution to avoid popping out of it.)

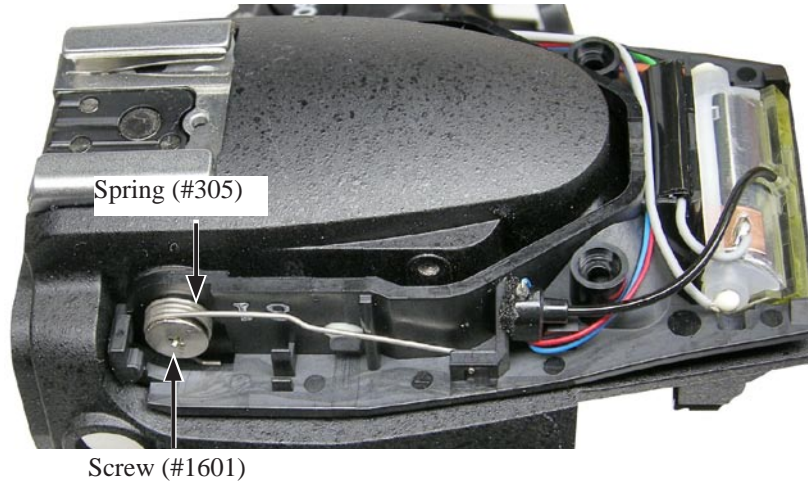

- Pass the wires from outside as below, and divide them into wires ([Gray][Red][Blue]) and wires ([Orange][Black][Green]) for arrangement.
- Tighten the screw (#1601).

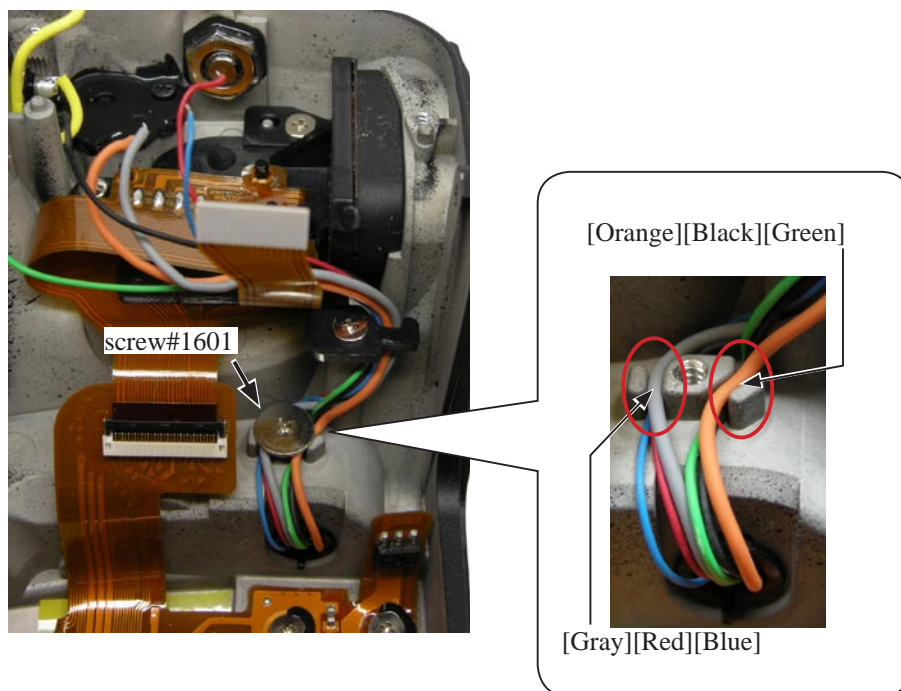
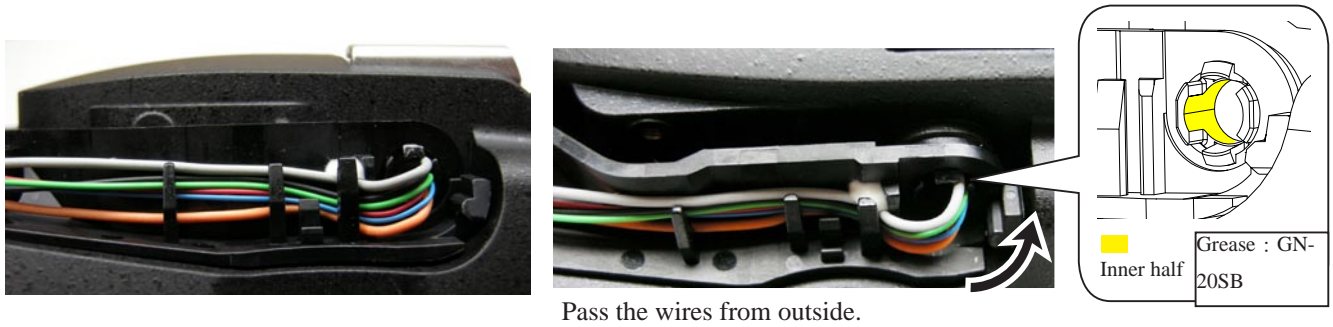

- Mount the SB upper cover (#301).



- Attach the two screws (#1623) to the SB upper cover (#301).



- Hook the two SB pop-up arms (#322), and tighten the two screws (#796).

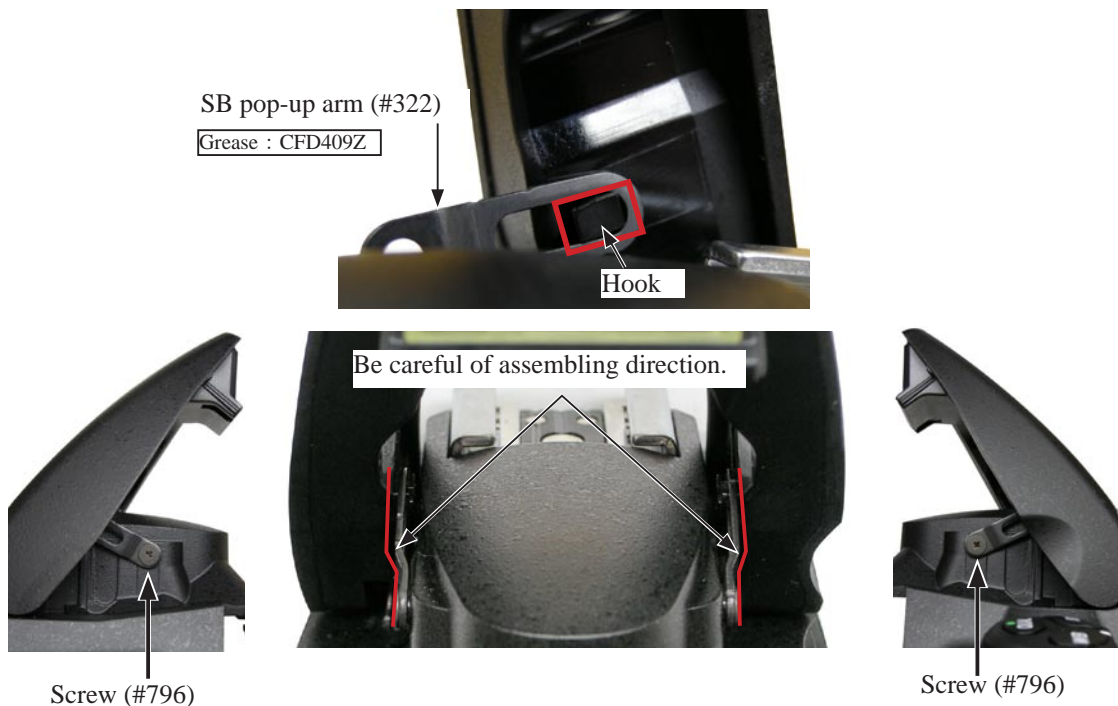

Release SW

- Attach the release SW unit (#B735) by fitting with the bosses.

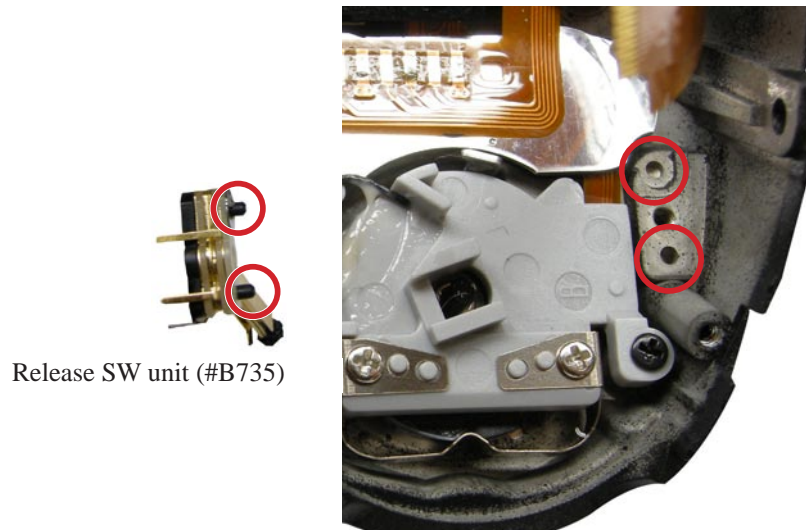

- Tighten the screw (#1605).
- Attach the Tape (#949).

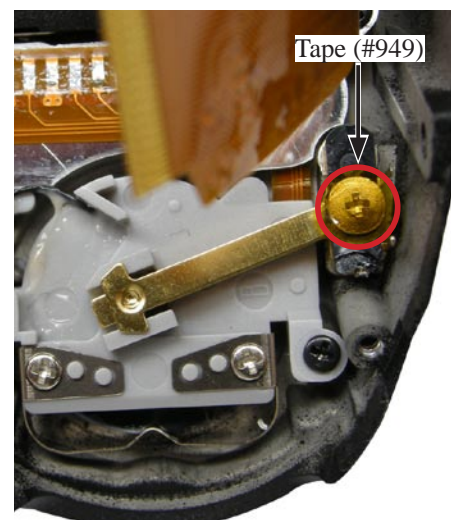
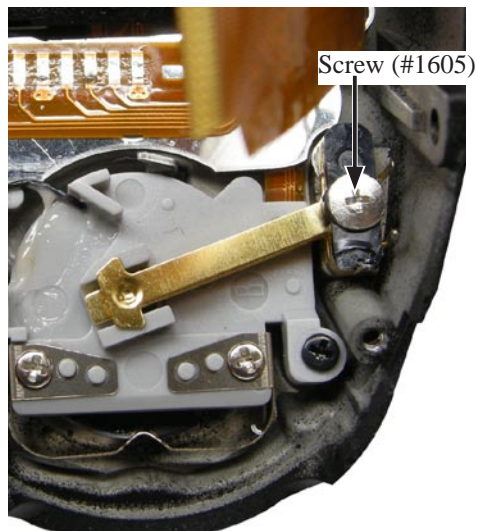

SB PCB unit

- Mount the SB PCB (#5013).
- Tighten the two screws (#1541).
- Solder the wires ([Yellow][Green][Black][Orange][Gray][Blue][Red]).
- Connect the FPC to the connector.

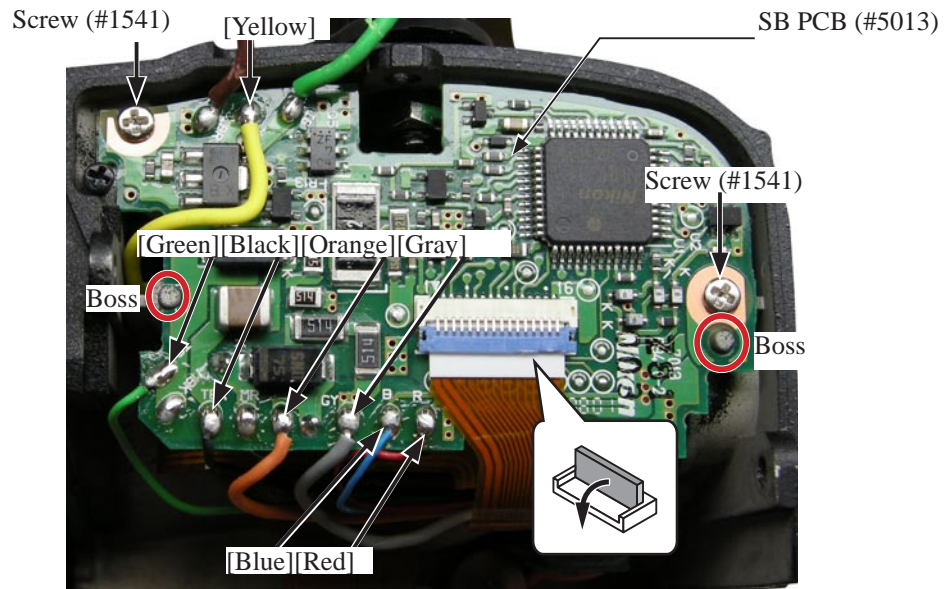

- Attach the tape (#929).



- Solder the wires ([Black][Red][Yellow]) of the metering mode FPC.

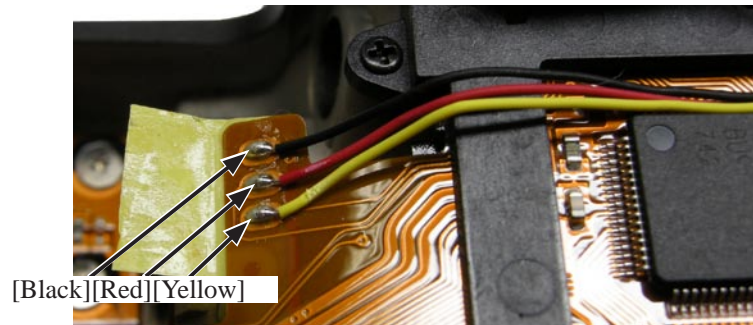

- Attach the tape (#929) at two places.
- Put the wires in the cutout together for arrangement.

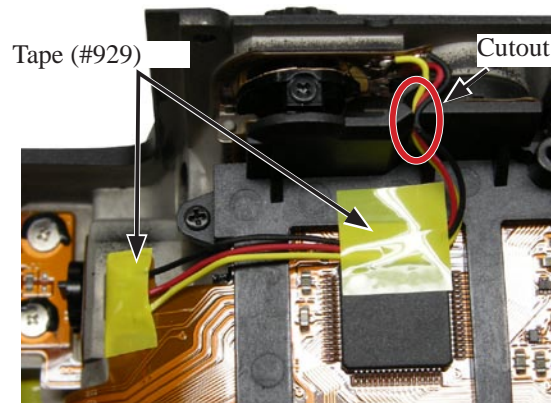

CD unit

- Mount the rear C/D unit (#B726), and tighten the two screws (#1571).
- Position the sub-command dial unit (#B725) in the direction of the arrow for mounting. Then, tighten the two screws (#1544).

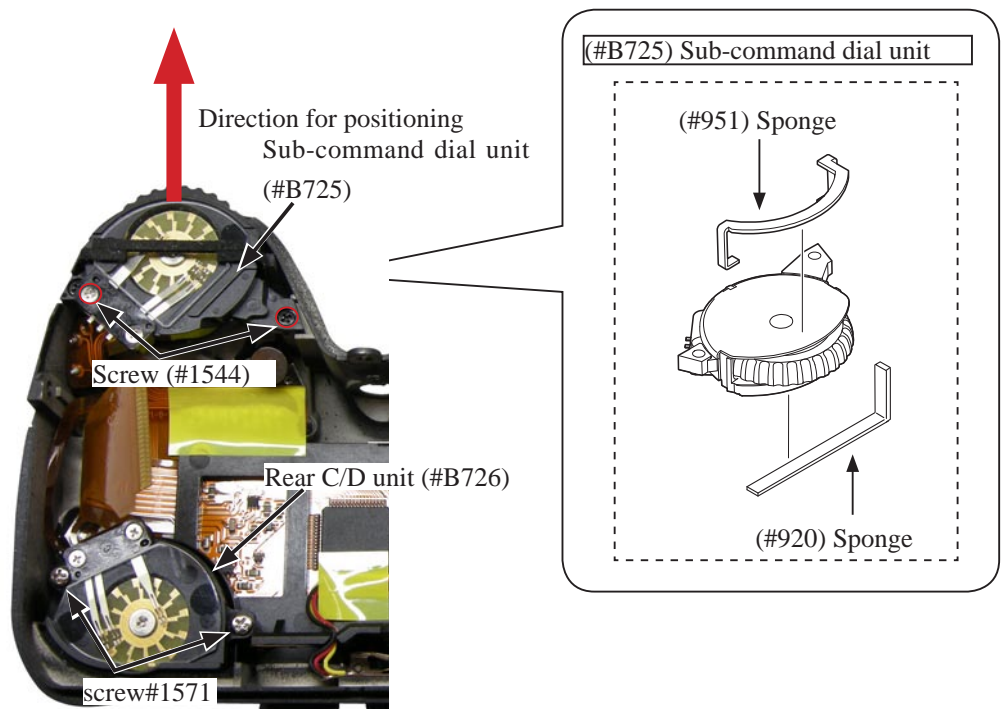

- Solder at three places.



- Attach the top cover FPC (#5003) and release SW FPC (#5033) by fitting the bosses, and solder them as below.
- Attach the tape [#TA-0005 (10×20)].

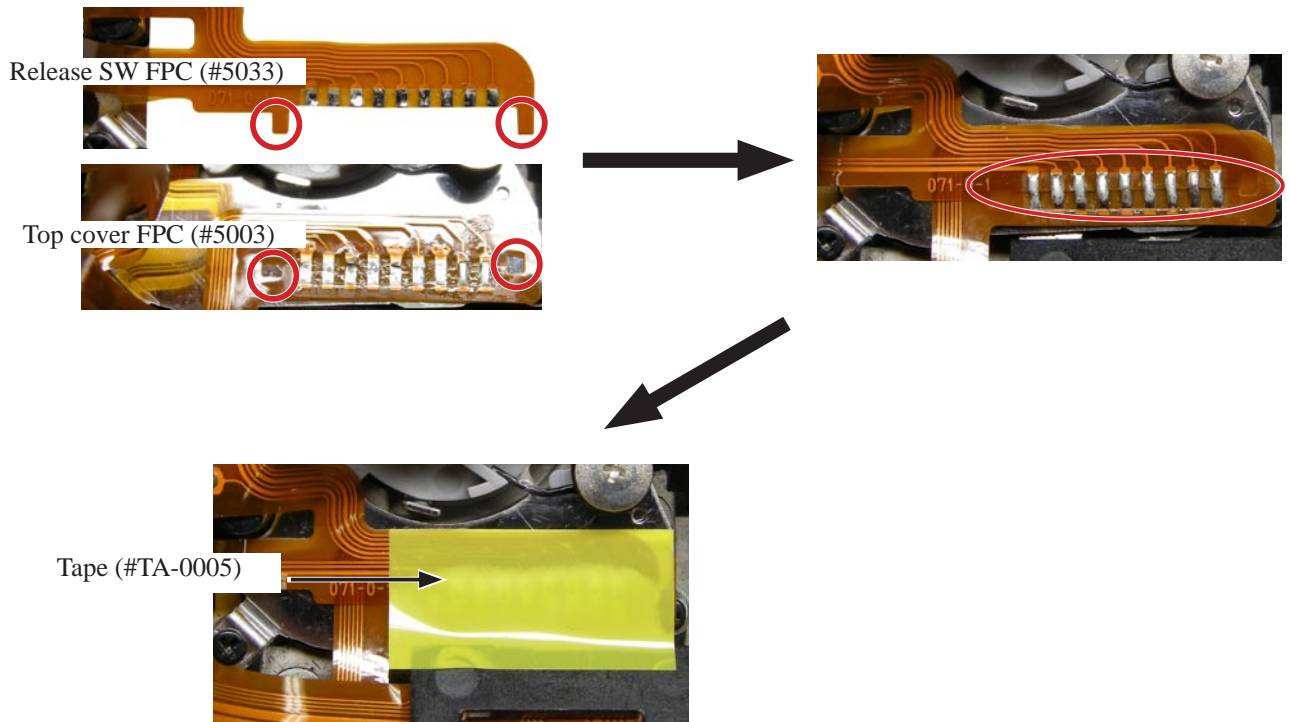

Main condenser

- Solder the wires [Black][Red] of the main condenser (#5067).

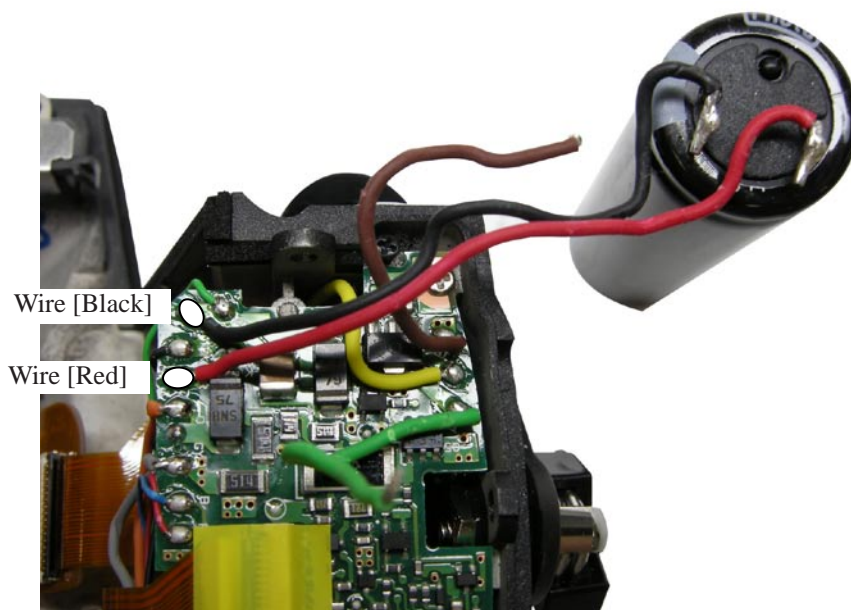

7. External Section and Imaging-related PCB

Mounting of Top cover

Caution: When the top cover is mounted, the top cover may interfere with the metering FPC, causing a misalignment of the AE-CCD. Therefore, be sure to make the AE-CCD positioning inspection again. (ref. Page A61)

- Connect the FPC.

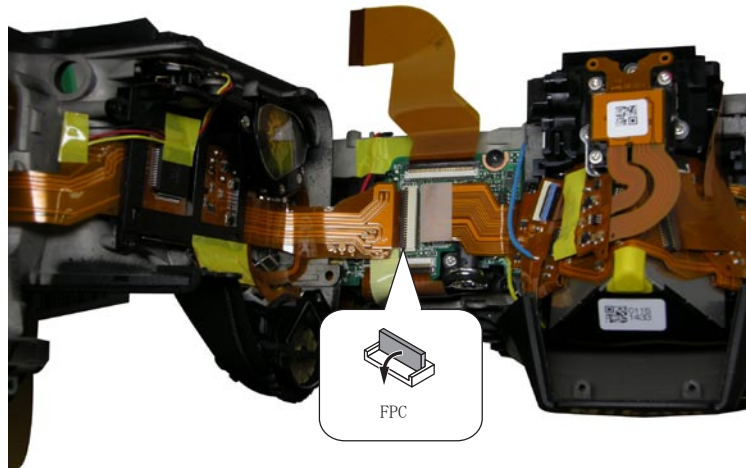

- With the SB being raised, mount the top cover on the body.



Leave the SB open.

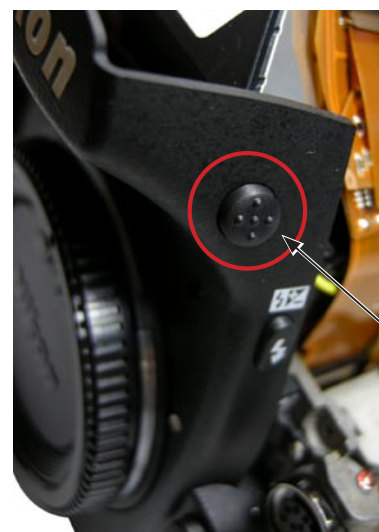

SB pop-up
button (#40)

With the SB pop-up button (#40) being sticking out, make assembly.

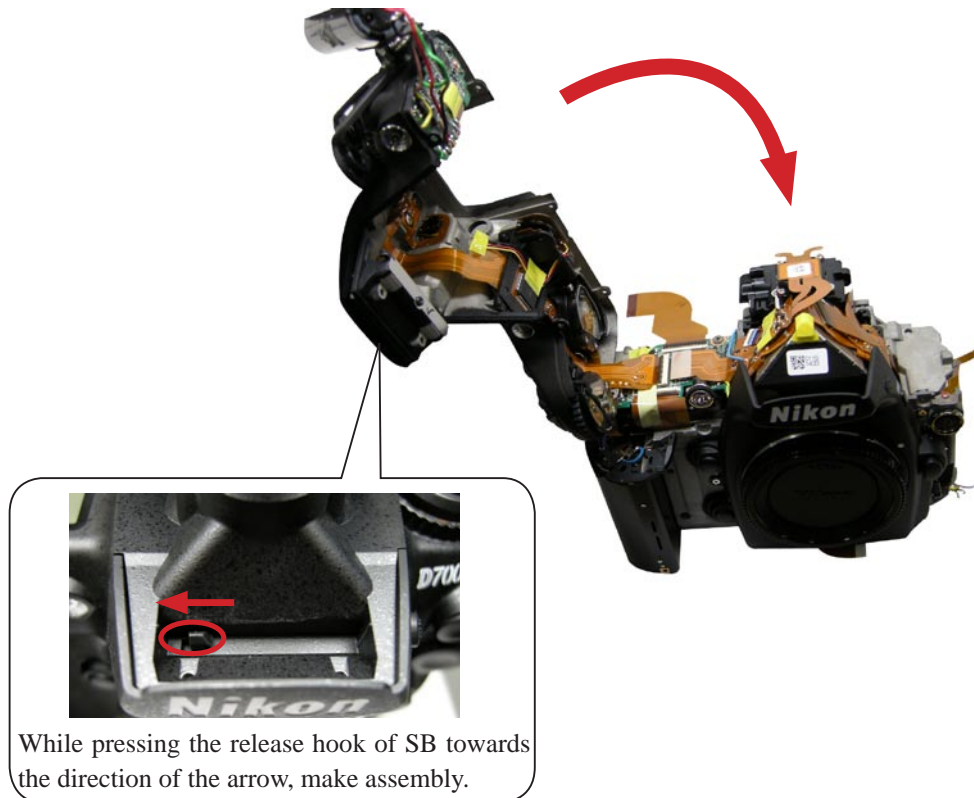

- Tighten the two screws (#1548) in the order from ① to ② .

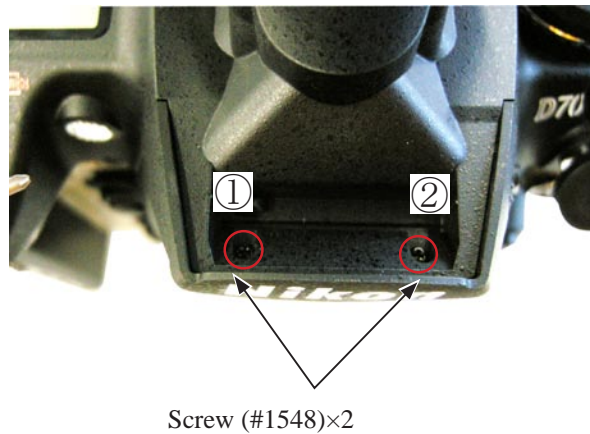

- Get the SB down.



- Tighten the two screws (#1509) in the order from ① to ② .



- Tighten the two screws (#1511) in the order from ① to ② .
- Tighten the screw (#1512).

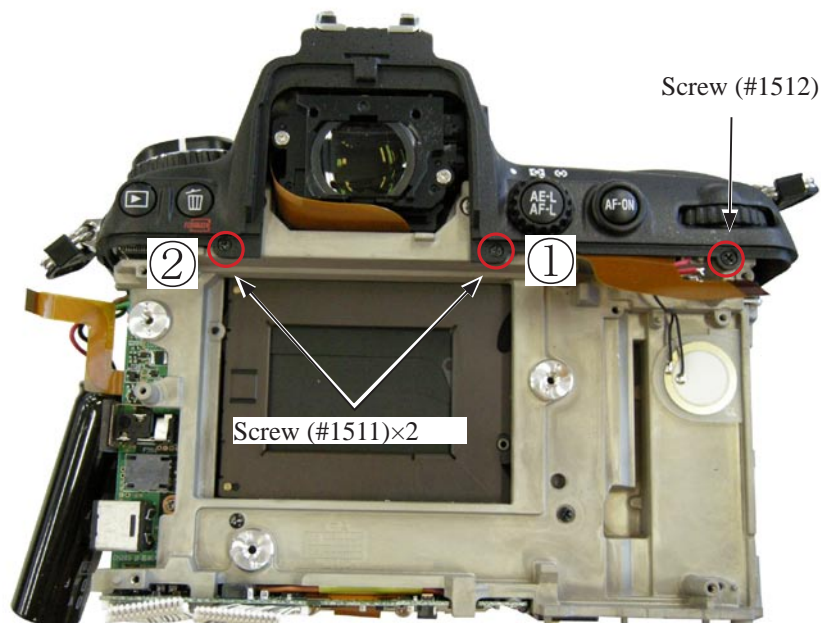

- Tighten the two screws (#1512).

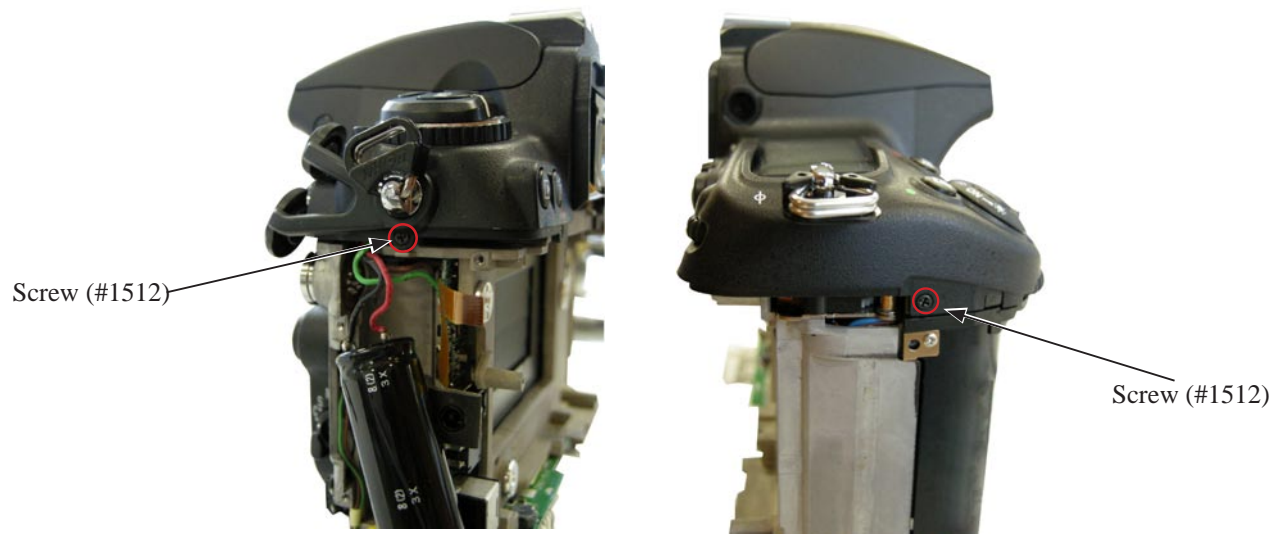

- Solder the wires ([Green][Brown]).

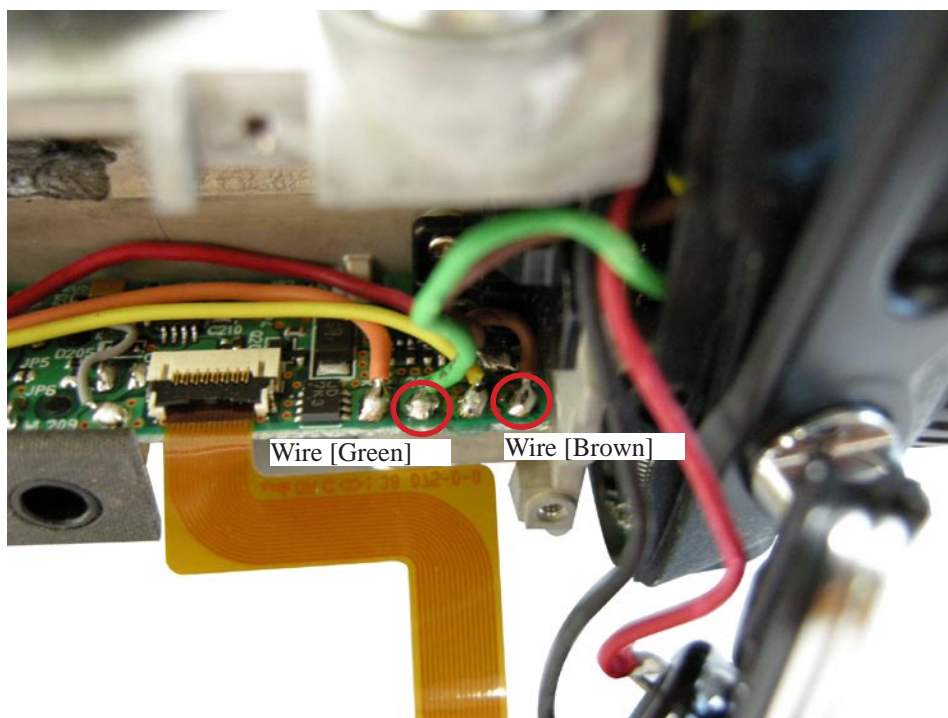

- Attach the double-stick tape (#915).

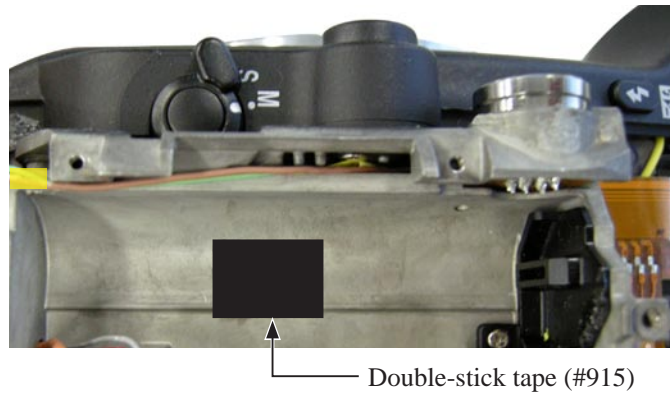

- Mount the condenser.

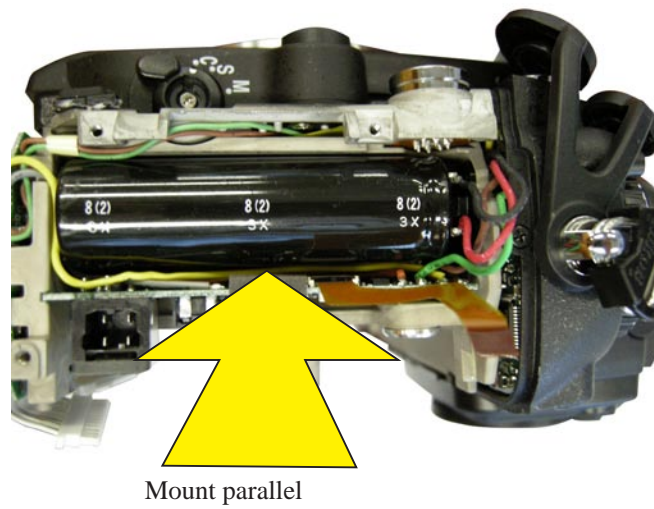

- Arrange the wires as below.

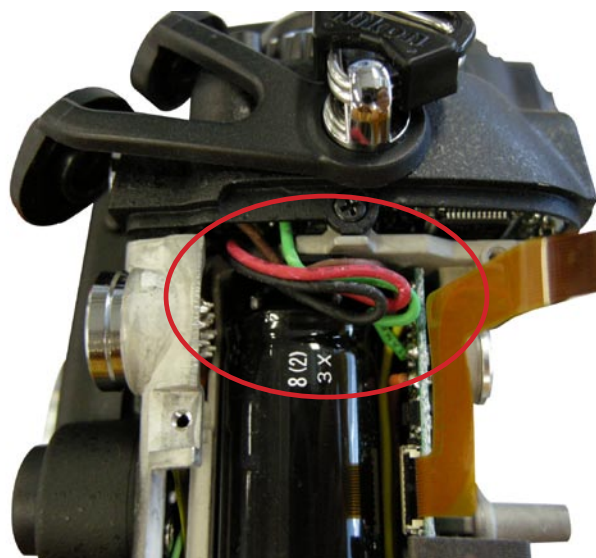

Inspection and Adjustment of M1/8000 accuracy

〈RS232C connection〉

Caution: Whenever the shutter unit is disassembled/replaced, or the main PCB is replaced, be sure to make this adjustment.

Procedure

- ① Turn the power SW ON of the shutter tester to light up the lamp. Set luminance to "LV15", and perform aging 3-5 minutes.
- ② Press "EXP.T" button of the shutter tester.
- ③ Connect the camera and PC via cable (R232C).
- ④ Connect "EH-5".

Be careful NOT to cause short-circuit in places uncovered.

- ⑤ Mount the AF50/1.4D on the camera, and set the focus ring to INFINITY.
- ⑥ Start D700 camera inspection and adjustment software.
- ⑦ Set the light-receiving adapter (J61230) to the shutter section of the camera, and attach the light-receiving sensor of the shutter tester.
- ⑧ Make inspection by "Inspection and adjustment of M1/8000 accuracy", and "Release for Insp"
- ⑨ If the result is out of standard, input the figure in the left column, and press "Adjustment".
- ⑩ Inspect again by "Release for Insp". (Repeat the procedure of ⑧⑨ until the result become within standard.)

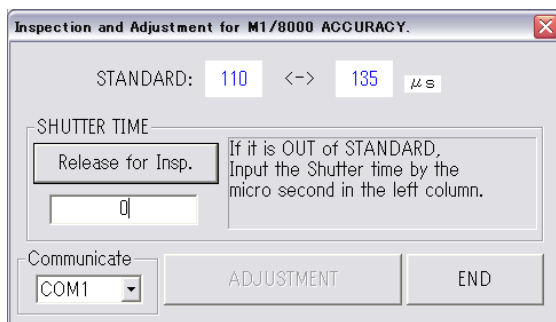
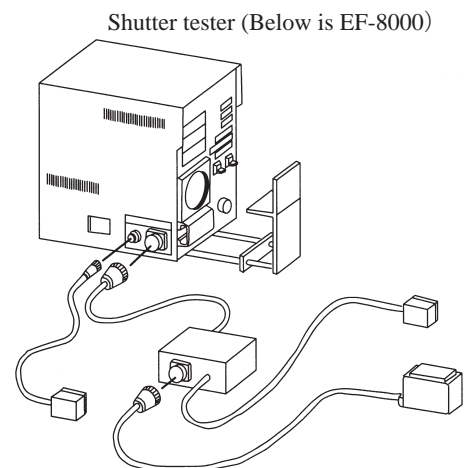
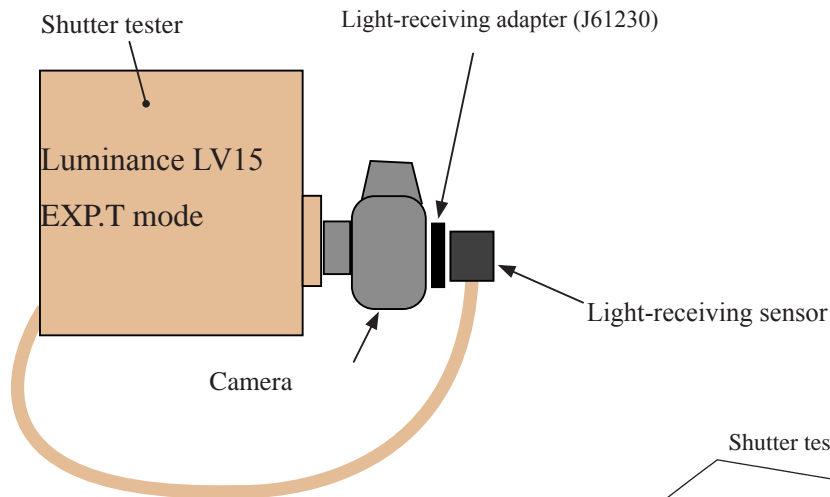

Device

 <p>J19123 SHUTTER TESTER EF-1(CE)</p>	 <p>J18267 AF50/1.4D LENS AF50/1.4D</p>	 <p>J61230 D3 LIGHT RECEIVE ADAPTER</p>
---	--	--

Inspection and adjustment of Shutter monitor

 <RS232C connection>

Caution: Whenever the shutter unit is disassembled/replaced, or the main PCB is replaced, be sure to make this adjustment.

Procedure

- ① Turn the power SW ON of the shutter tester to light up the lamp. Set luminance to "LV15", and perform aging 3-5 minutes.
- ② Press "EXP.T" button of the shutter tester.
- ③ Connect the camera and PC via cable (R232C).
- ④ Connect "EH-5".

Be careful NOT to cause short-circuit in places uncovered.

- ⑤ Mount the AF50/1.4D on the camera, and set the focus ring to INFINITY.
- ⑥ Start D700 camera inspection and adjustment software.
- ⑦ Set the light-receiving adapter (J61230) to the shutter section of the camera, and attach the light-receiving sensor of the shutter tester.

Inspection

- ⑧ Measure the shutter speed by "Inspection and adjustment of Shutter monitor", and "Release for insp".
- ⑨ Input the figure of ⑧ in "Measurement value", and press "Inspection".

Adjustment (in case of nonstandard)

- ⑩ Press "Release for Adj", and measure the shutter speed three times. Then, input each value in the left column.
- ⑪ Press "Adjustment " for adjustment.

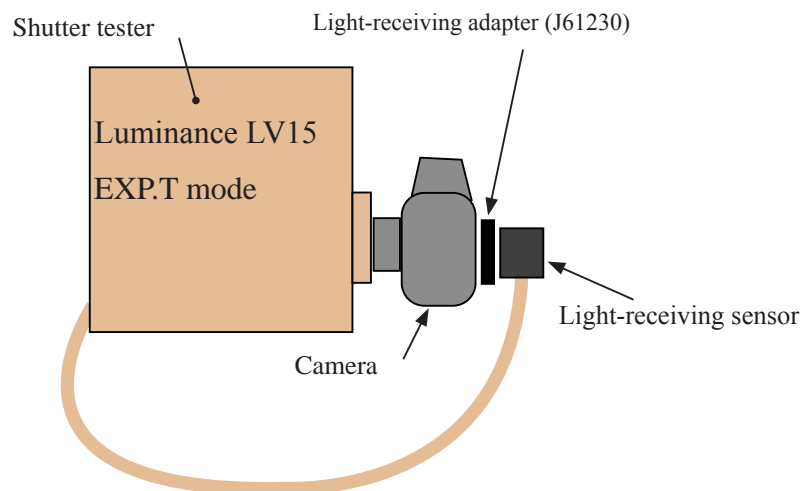

Device

<p>J19123 SHUTTER TESTER EF-1(CE)</p>	<p>J18267 AF50/1.4D LENS AF50/1.4D</p>	<p>J61230 D3 LIGHT RECEIVE ADAPTER</p>
---	--	--

Battery check voltage inspection



(RS232C connection)

When this camera is used for measuring the consumption current value, set the MB-D10 and wire as follows.

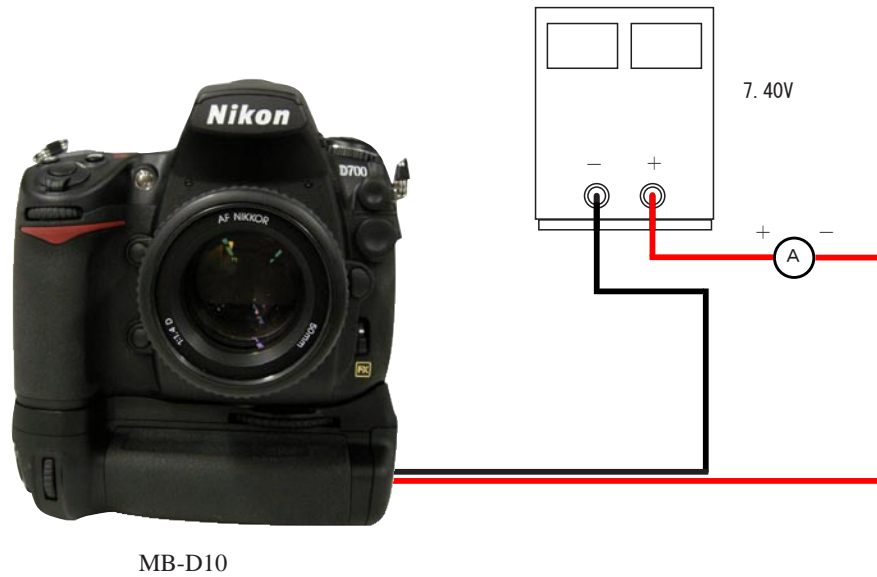
* Modify "MB-D10" and connect wires.



Device

 <p style="text-align: center;">POWER SUPPLY(10V 5A)</p>	 <p style="text-align: center;">Modified power code</p>	 <p style="text-align: center;">MB-D10 BATTERY PACK MB - D 1 0</p>
---	---	---

Eyepiece

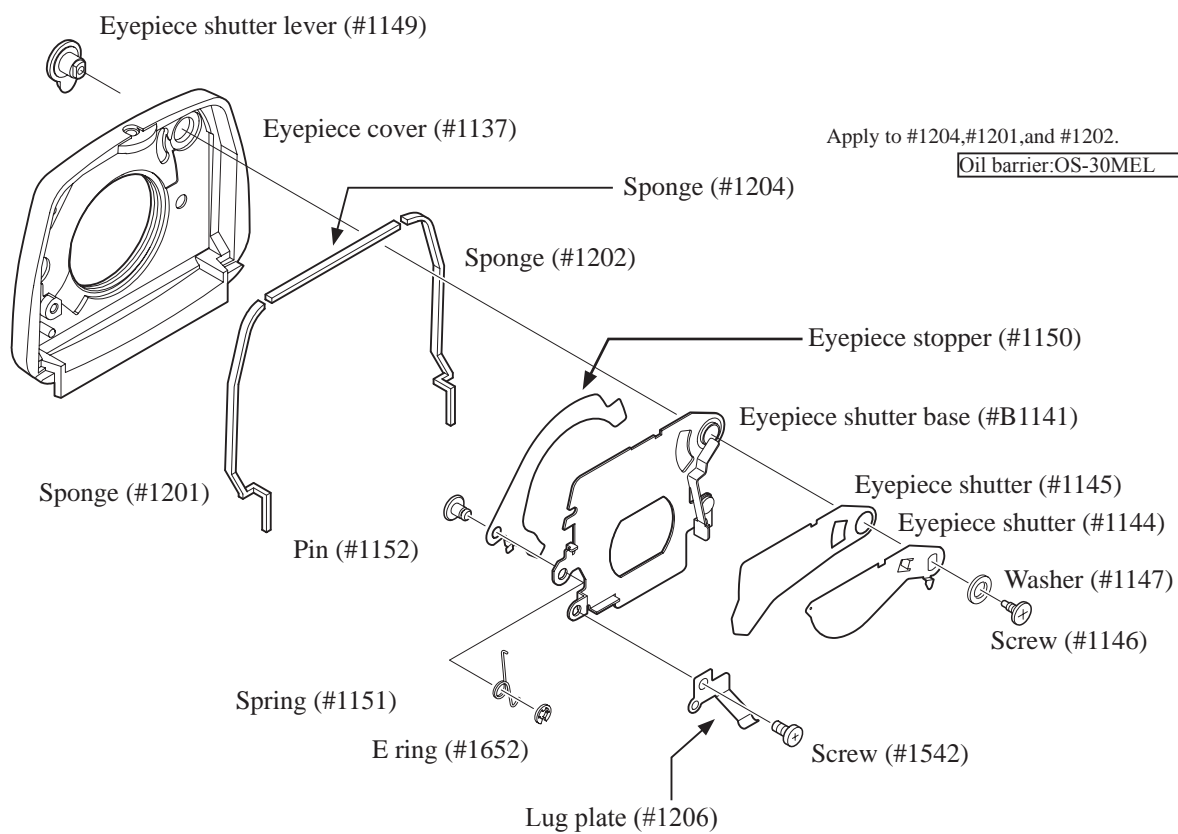

- Mount the eyepiece.
- Tighten the screw (#1534).



Diopter adjustment knob

- Attach the diopter adjustment knob (#1121).
- Tighten the screw (#1552).

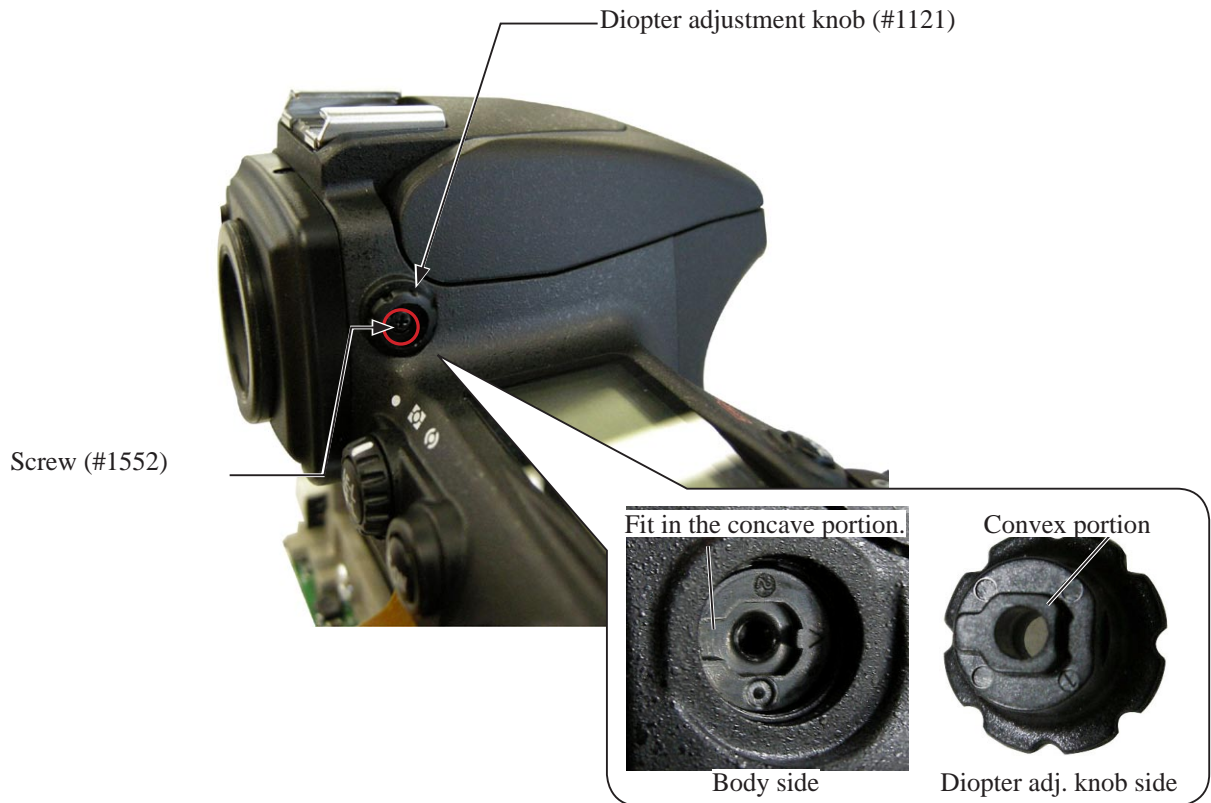

- Attach the cover (#1130).



CF PCB

- Connect the connection-FPC (#5038) to the connector of the CF PCB (#5018).
- Position the lever of CF PCB (#5018) towards the direction of the arrow.

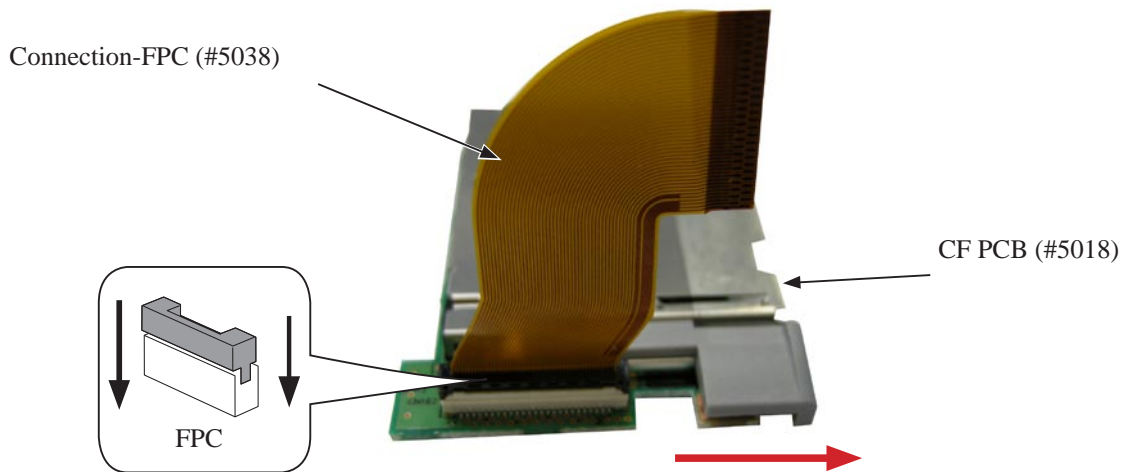

- Mount the CF-PCB (#5018).

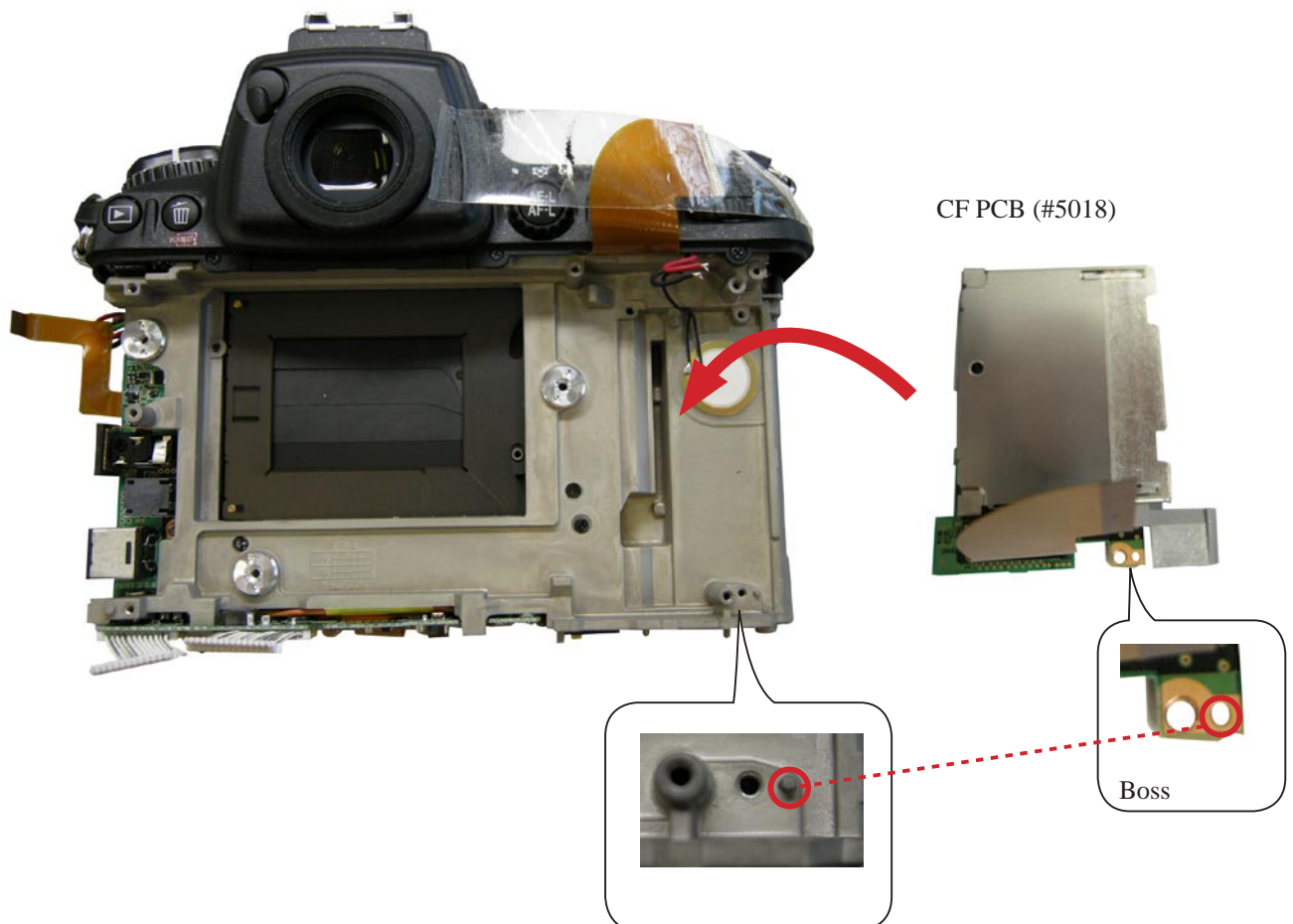

• Tighten the three screws (#1543) in numeric order (① → ② → ③).

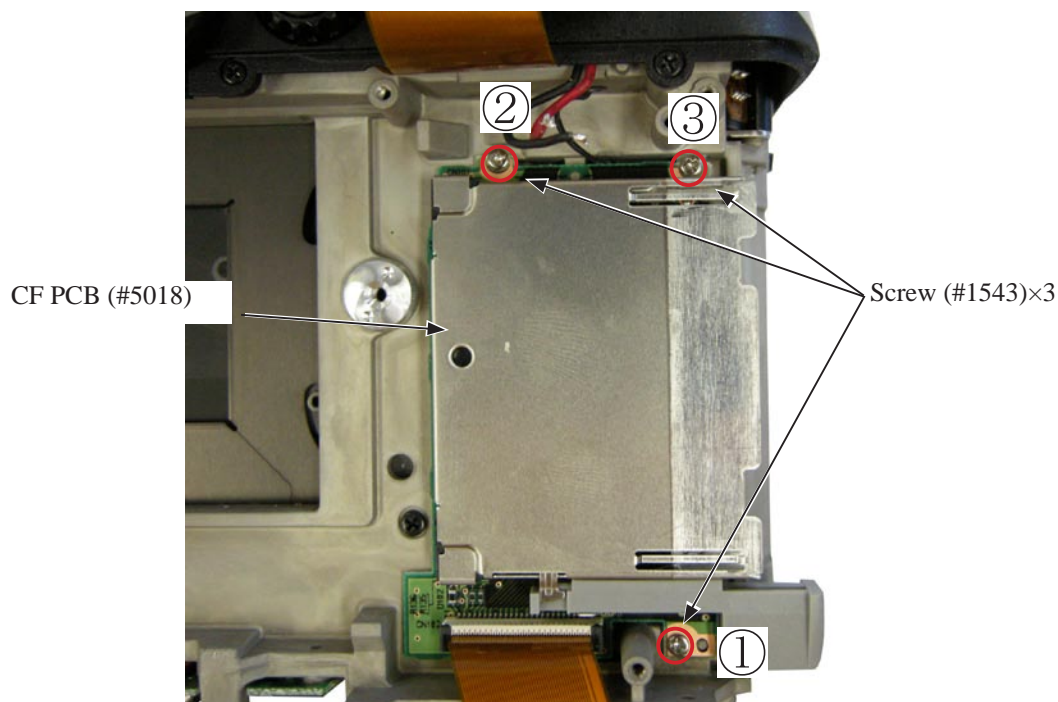
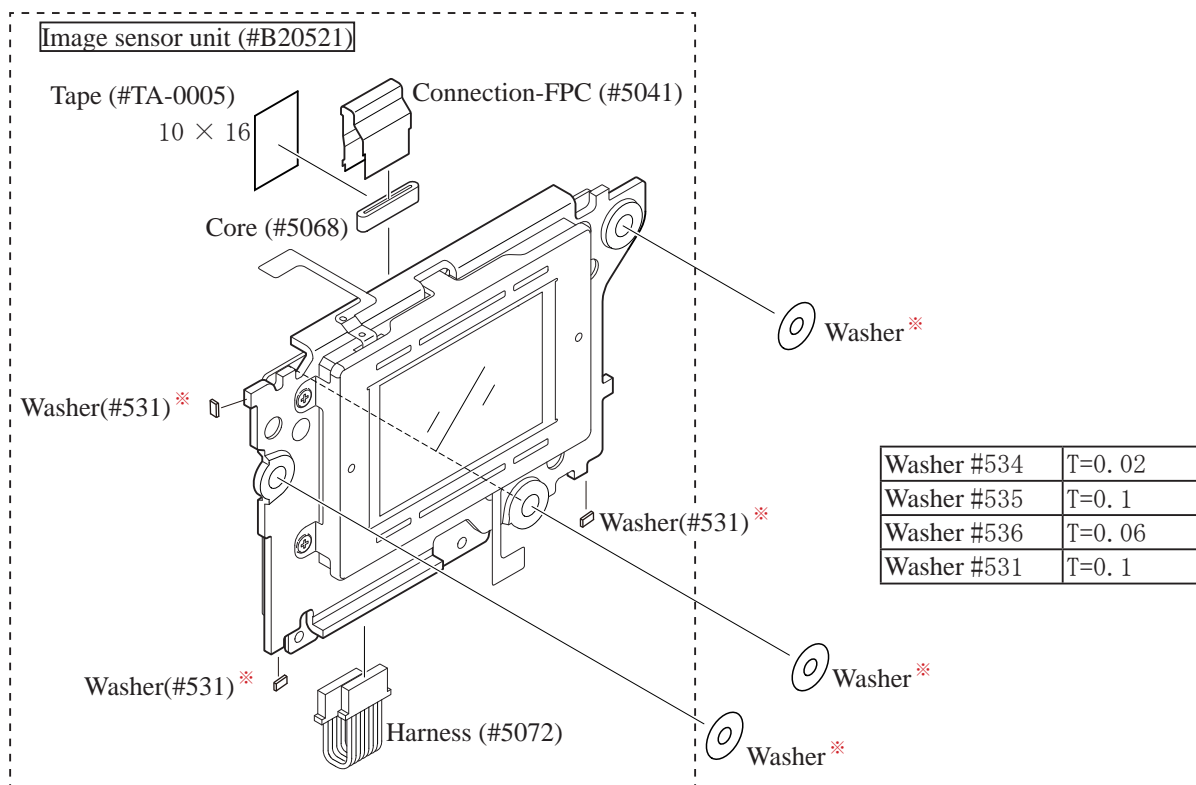

Image sensor unit



※ As for some bodies, the attaching surface and lateral face of the image sensor unit (#B20521) have washers attached. ref.Page A51

- Writing of the image sensor unique data

Because the QR code screen, which was photographed by the procedure of the image adjustment software, is read with two-dimensional barcode reader and also the unique data of the image sensor is written in the DG PCB, **take a picture beforehand of the QR code, which is attached to the image sensor unit, by a digital camera BEFORE assembly.**

- When the image sensor holder unit is replaced, or the DG-PCB unit and the image sensor holder unit are replaced, take a picture of the QR code of the image sensor of RP.
- When the DG-PCB unit is replaced, take a picture of the QR code of the image sensor holder unit that is attached to the body.

【Shooting condition】

Compact digital camera is used:

- Quality: FINE
- Size: 3M
- Shooting mode: BSS
- AF mode: Closeup mode
- SB mode: Flash cancel

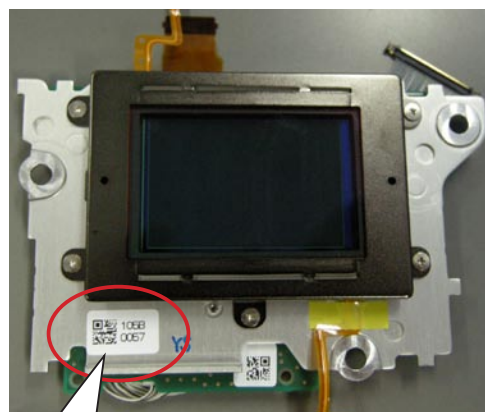

【How to confirm】

* Perform "QrReader (J65096)". Play back the image of the shot QR code, and confirm that reading of the QR code on the playback screen can be read out with two-dimensional barcode reader. (Refer to Page A129 for how to set two-dimensional barcode reader.)

△ (Addition)

△ (Addition)

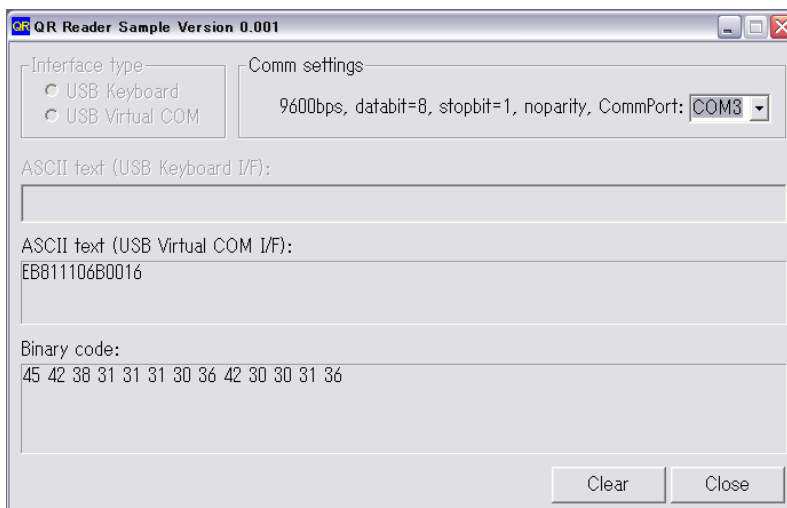

- Mount the image sensor unit (#B20521).
- Tighten the three screws (#525) in numeric order (① → ② → ③).
- Place the wires ([Brown][Orange]) under the image sensor unit.

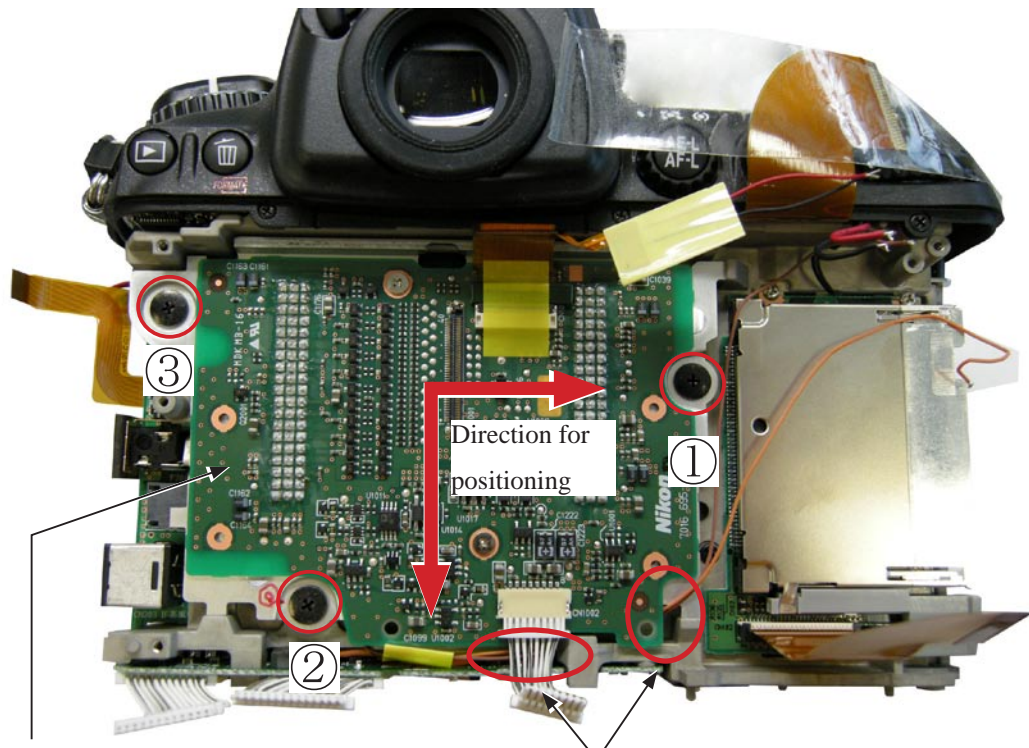

Image sensor unit (#B20521)

Place the wires ([Brown][Orange]) under the image sensor unit.

- Attach the harness(#5073).
- Attach the tape [#TA-0005 (5×15)] for arranging the wires ([Brown][Orange]).

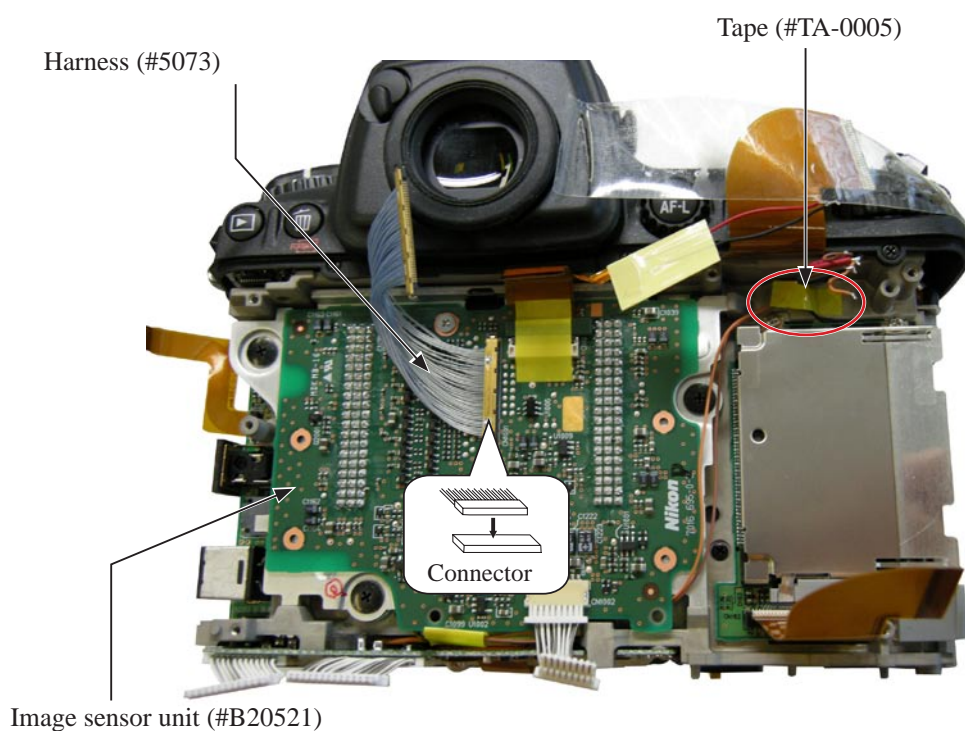
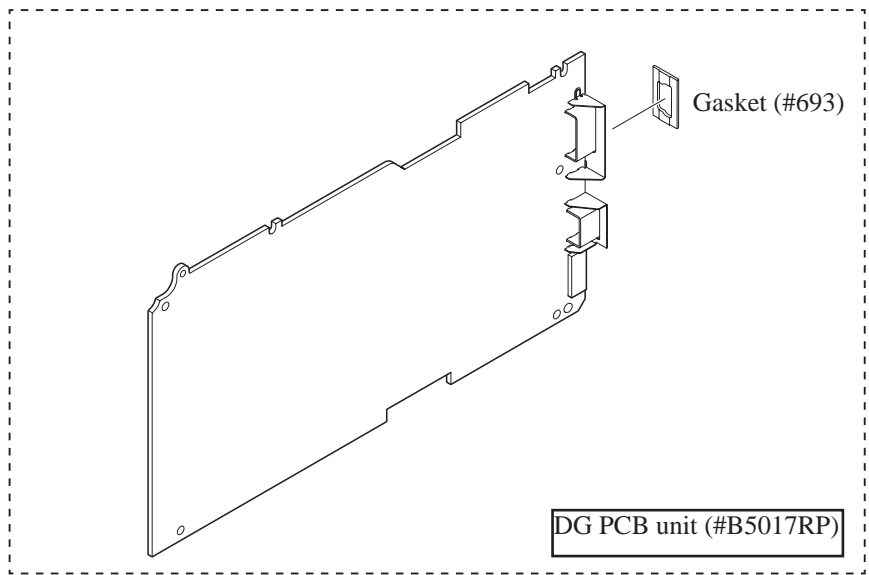
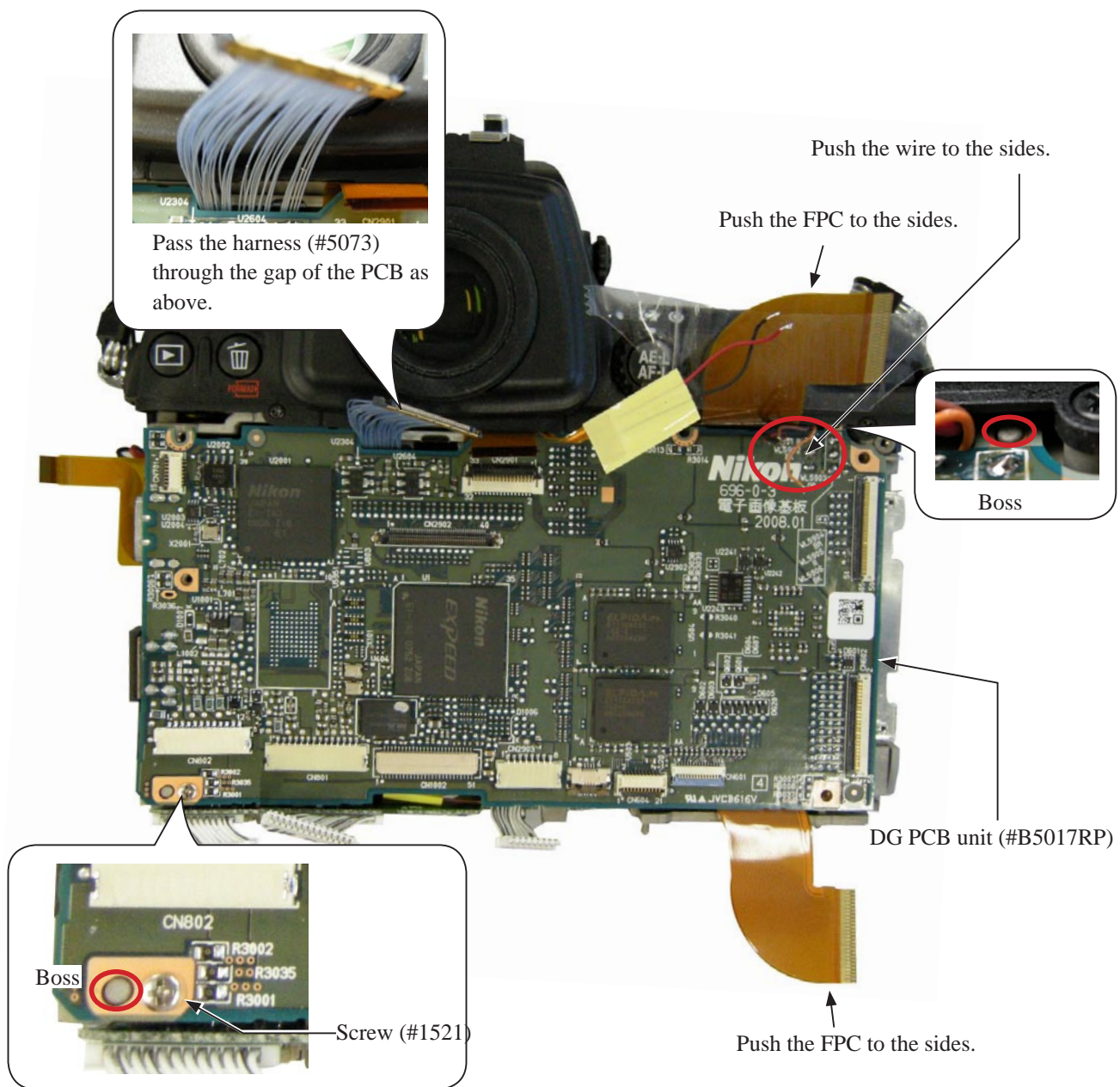

Image sensor unit (#B20521)

DG PCB



- Mount the DG PCB unit (#B5017RP), and tighten the screw (#1521).



- Solder the wires ([Red thin][Black thin][Orange]).

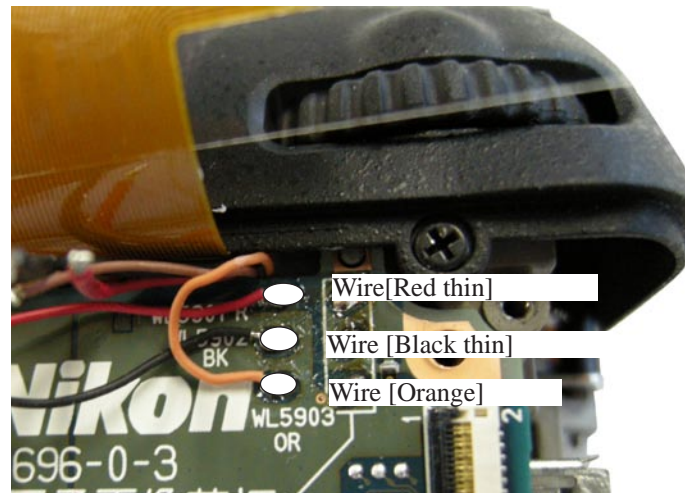

- Solder the wires ([Red thick][Black thick][Brown]).

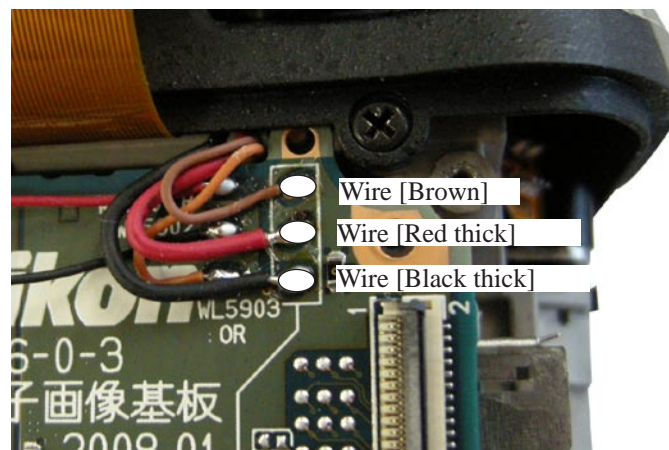

- Attach the power pack connection-FPC.

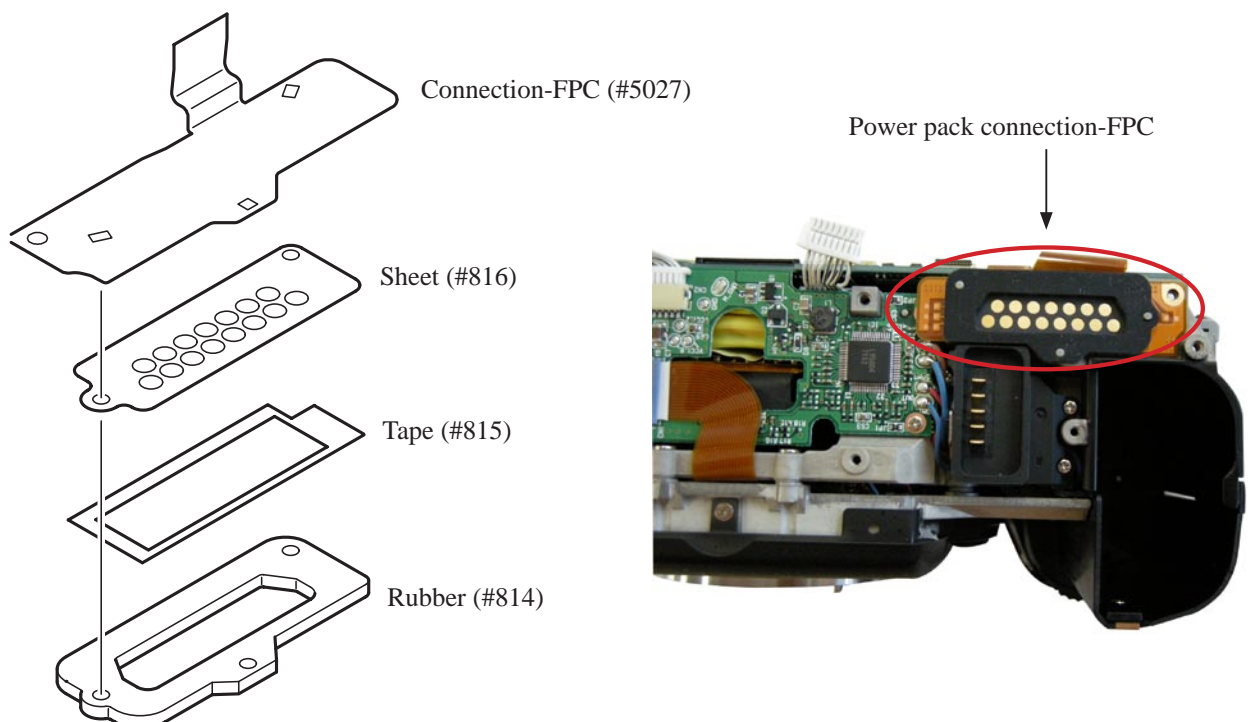

- Connect the four FPCs.
- Connect the two harnesses to the connectors.

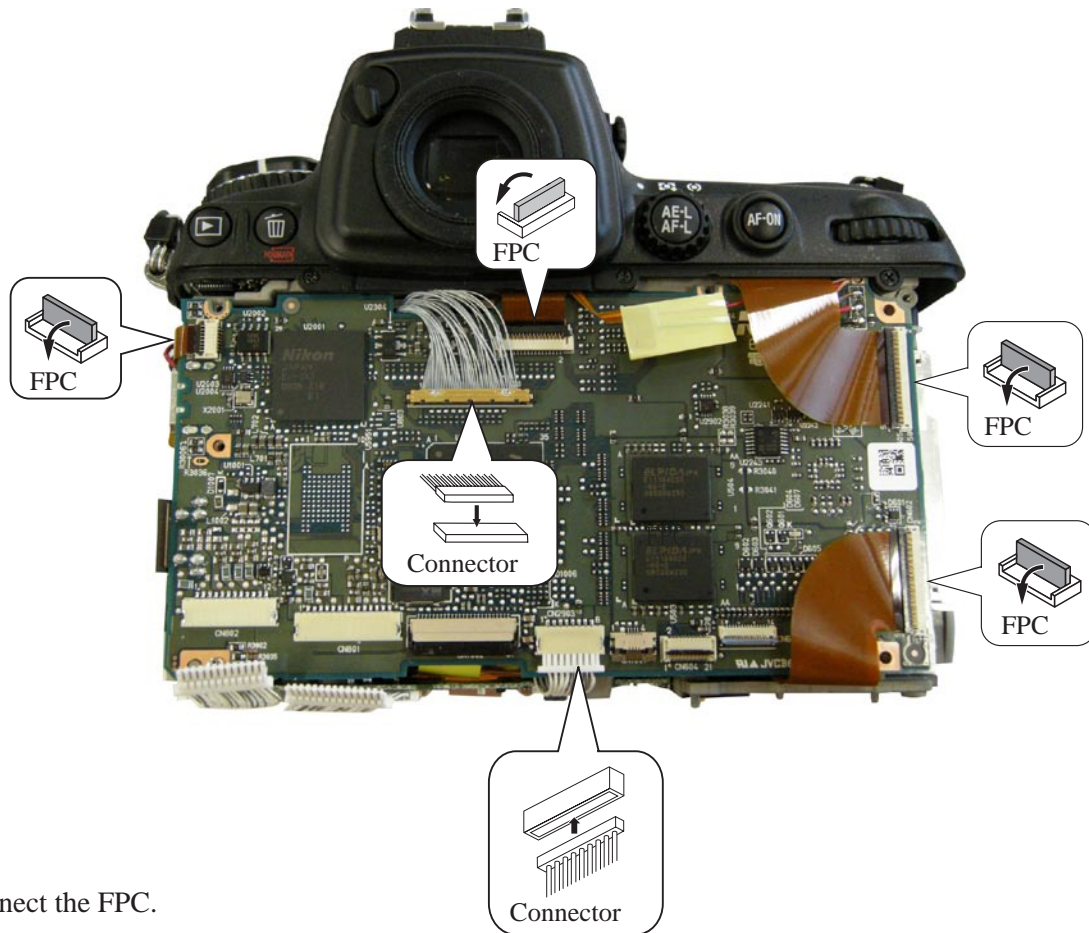

- Connect the FPC.
- Connect the two harnesses to the connectors.

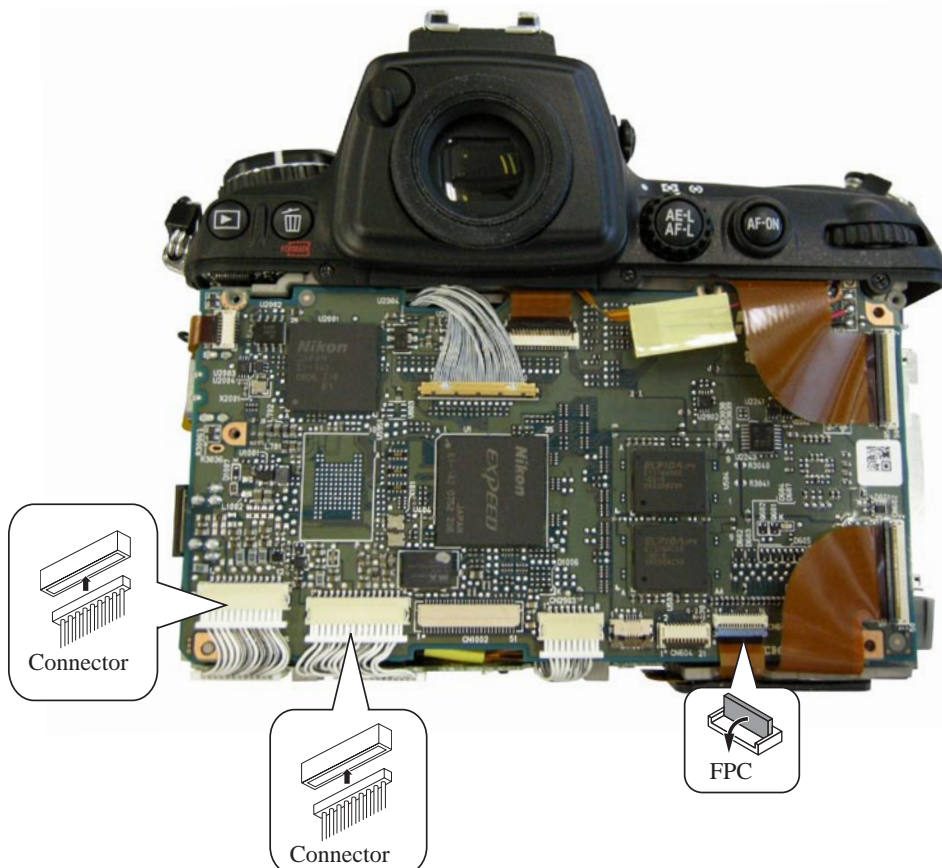

DG shield plate unit

- Mount the DG shield plate unit (#B683), and tighten the five screws (#1521) in numeric order (① → ② → ③ → ④ → ⑤).

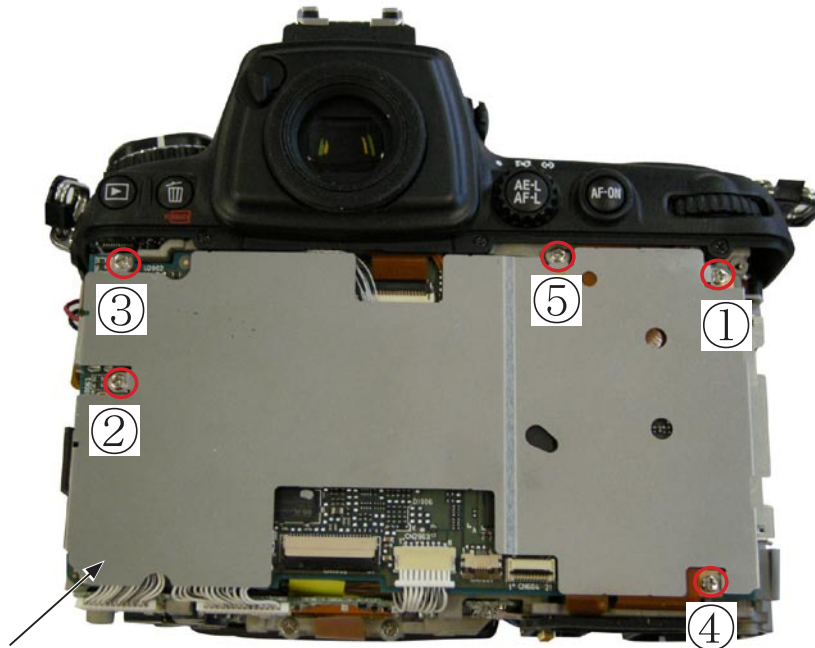

DG shield plate unit (#B683)

I/F cover

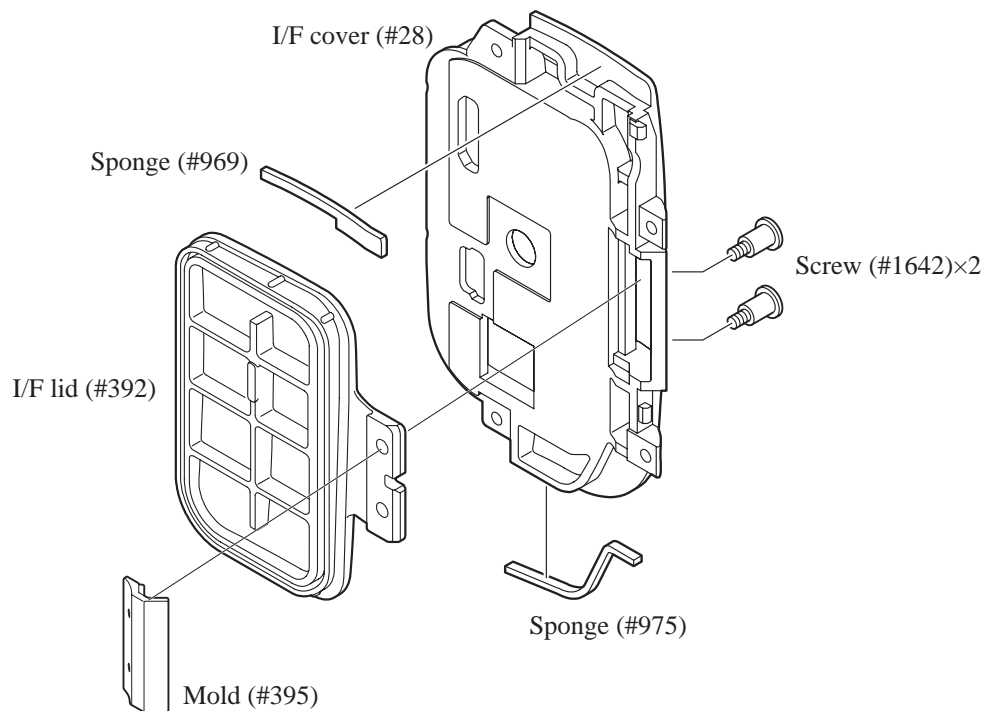

- Mount the I/F cover (#28).
- Tighten the two screws (#1510) in the order (① → ②).

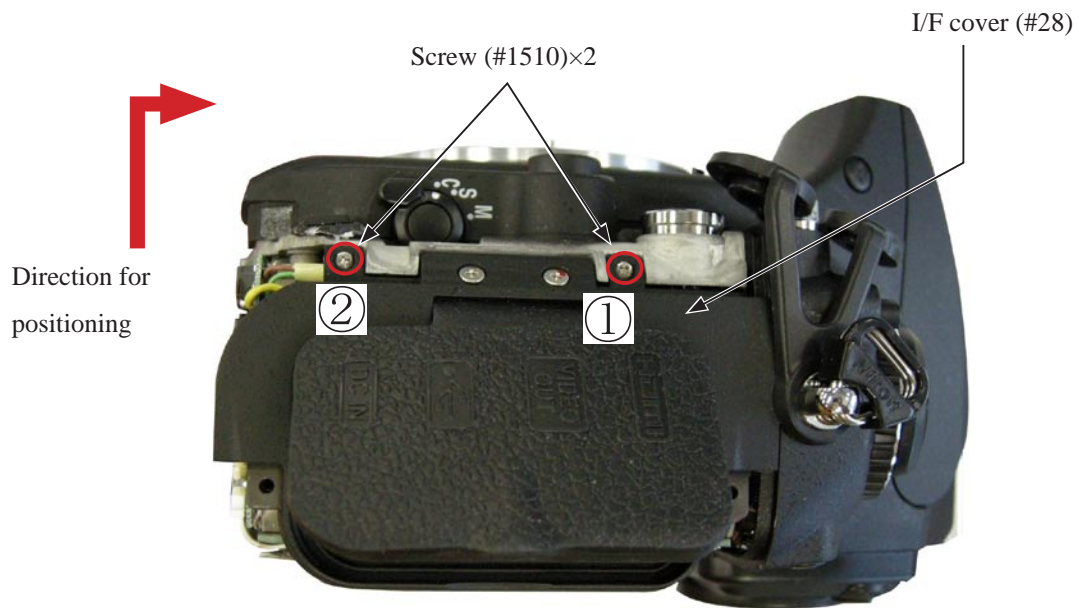

How to connect camra and PC

Caution: Because the tripod and battery pack are used, assemble the bottom cover temporarily.
Be careful of short-circuit in places uncovered.

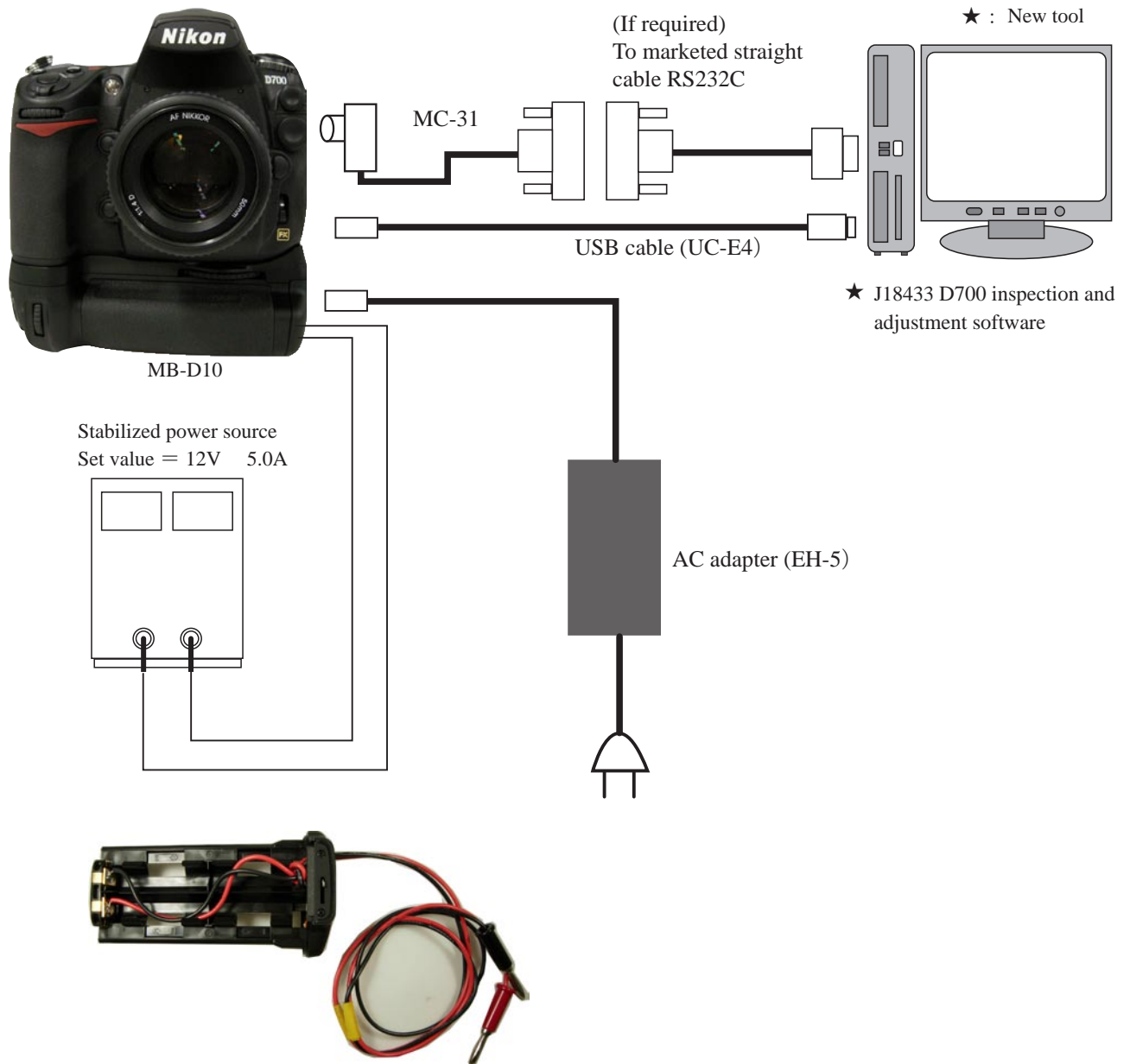

Caution: When the voltage adjustment is made, use MB-D10.
(Modify the MS-D10 size AA battery holder and attach the wires.)

D700 Inspection and Adjustment Software (J65119)

This inspection and adjustment software runs on Windows.

Install the software by following the below procedure.

<Operating environment>

Check the following operating environment which is required for installing this program on PC.

PC	IBM PC/AT compatible
OS	Windows XP Professional Edition, Windows XP Home Edition, Windows Vista, Windows2000,
CPU	Pentium II 300MHz
RAM (memory)	256 MB or more
HD	6MB-or-more free disk space is required when installing
Monitor resolution	1024 × 768 pixels or more
Interface	※ USB interface (V1.1, 2.0) RS232C(com1 ~ com9)

As long as the above hardware requirements are met, any PC such as desktop or laptop, etc is available.

< Cautions in starting program >

When starting this program, close all the other applications.

If some other applications are running, this program may not be activated.

< File >

D300.exe	Application execution file
NkdPTP.dll	Library file: USB communication application extension file for Windows XP
NkdPTPDi.dll	Library file: USB communication application extension file for Windows 2000
PTPControl	Driver file storing folder for PTP: for Windows 2000
D700IA.ini	File for storing setting conditions of adjustment software

<Procedure for installation>

Because this is the self-extracting file, decompress the file before installing, and follow the next procedure.

1. Create a folder for installation under any drive and name. C: \¥ DeskTopLauncher\D-SLR\D700

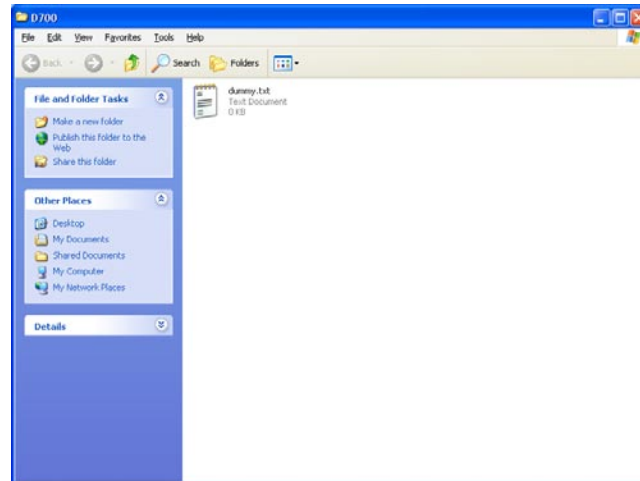

2. Paste the file (PD700.EXE) in the created folder.

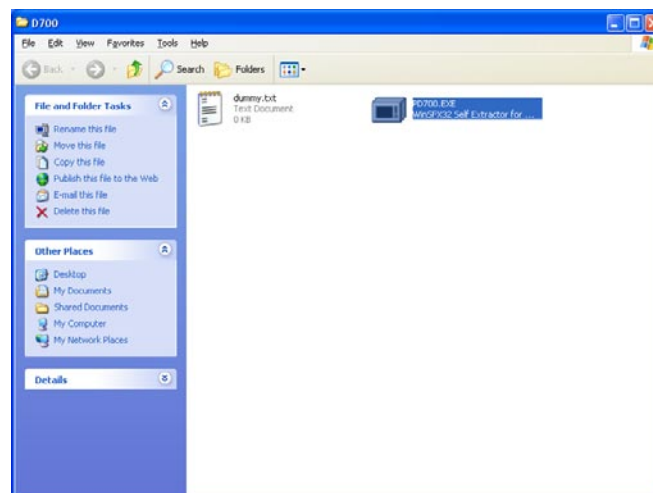

3. Double-click on the pasted file to display the following screen.

Press the OK button, then decompression starts.

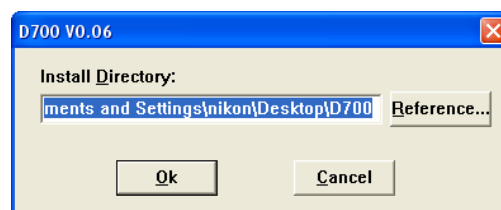

4. When the decompression of file is finished, the file (D700.exe) is created.

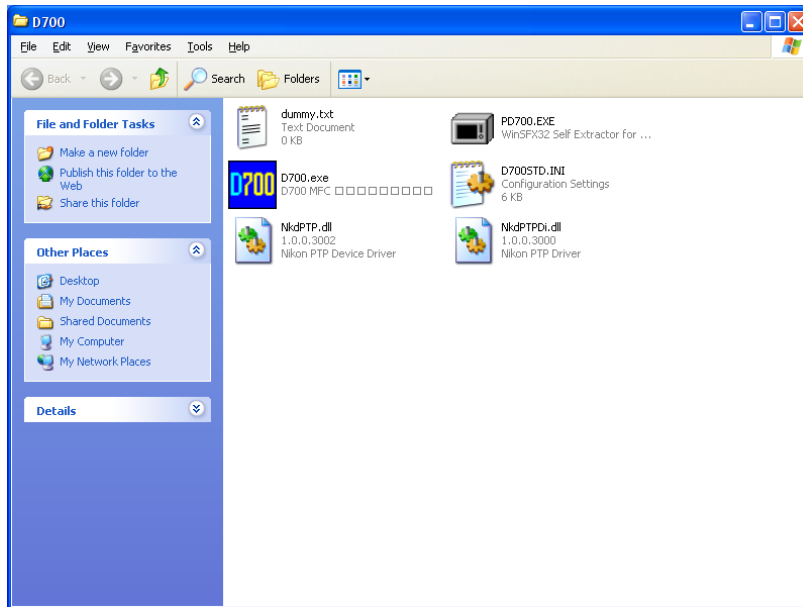

5. The install is completed.

【Start-up of Program】

1. When "D700. EXE" is started, the following window will appear. So type in the user key.
(ref. TIE07023)

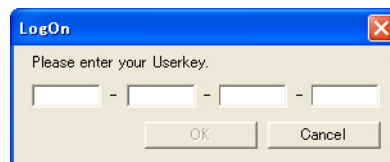

Caution:

Once the user key is typed, from the next time, the adjustment screen will appear from the beginning.

2. Then the following window will appear. Click "OK".

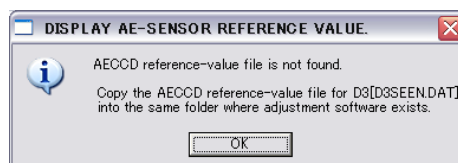

3. Click "OK". Program will start.

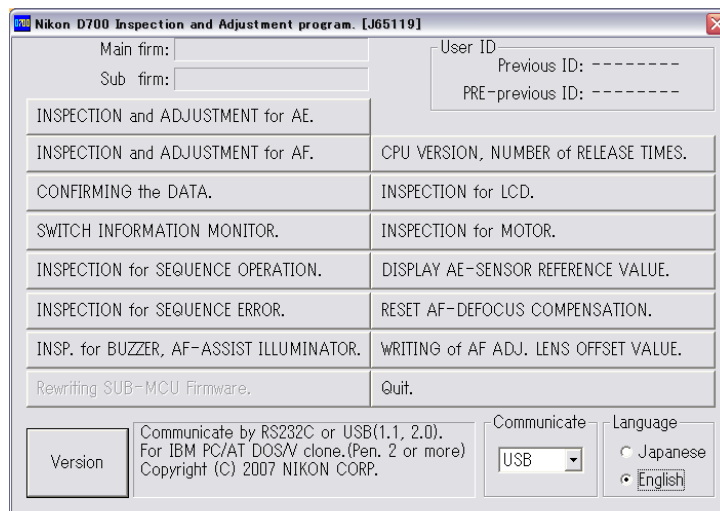

4. To display in Japanese, select the radio button of "Japanese" in "Language" at the lower right corner of the screen. However, the screen will not be displayed correctly by English OS.

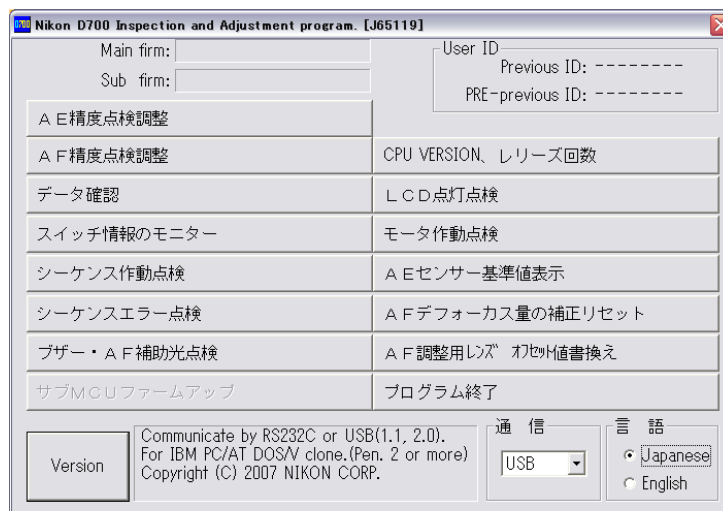

5. To end the program, click "Close (×) " button at the top right hand corner of the screen or click "Quit".

※ When the camera body (excluding imaging) is inspected and adjusted, the USB connection will be reset in the process of writing the data into the camera. Therefore, the following message will appear but does not affect the adjustment. Click "Cancel", and proceed with the next.



Procedure for installing USB driver

If this program is used by the USB interface, installing the USB driver is necessary.

But if the OS is "Windows XP", the driver is already preloaded so it is not necessary to install it.

(1) Connect the camera and PC by USB cable.

Turn camera ON.

(2) When "Add New Hardware Wizard" is displayed, click "Next".



(3) Select "Search for a better drive than the one your device is using now. (Recommended)", and click "Next".



(4) Click "Reference" of "Specify a location" and select the directory where the driver was copied, such as "C:¥D700¥PTP". Then click "Next".



(5) Confirm that the driver is located at the right place, and click "Next".

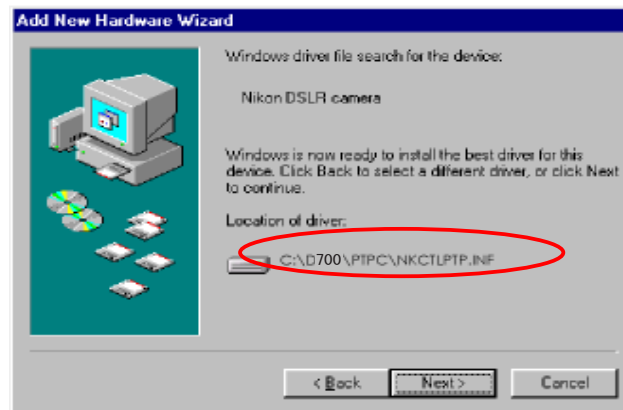

(6) Click "Finish".

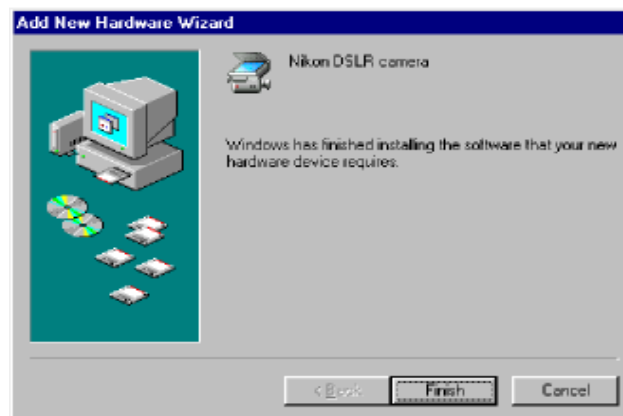

(7) Reboot the PC to complete the installation.

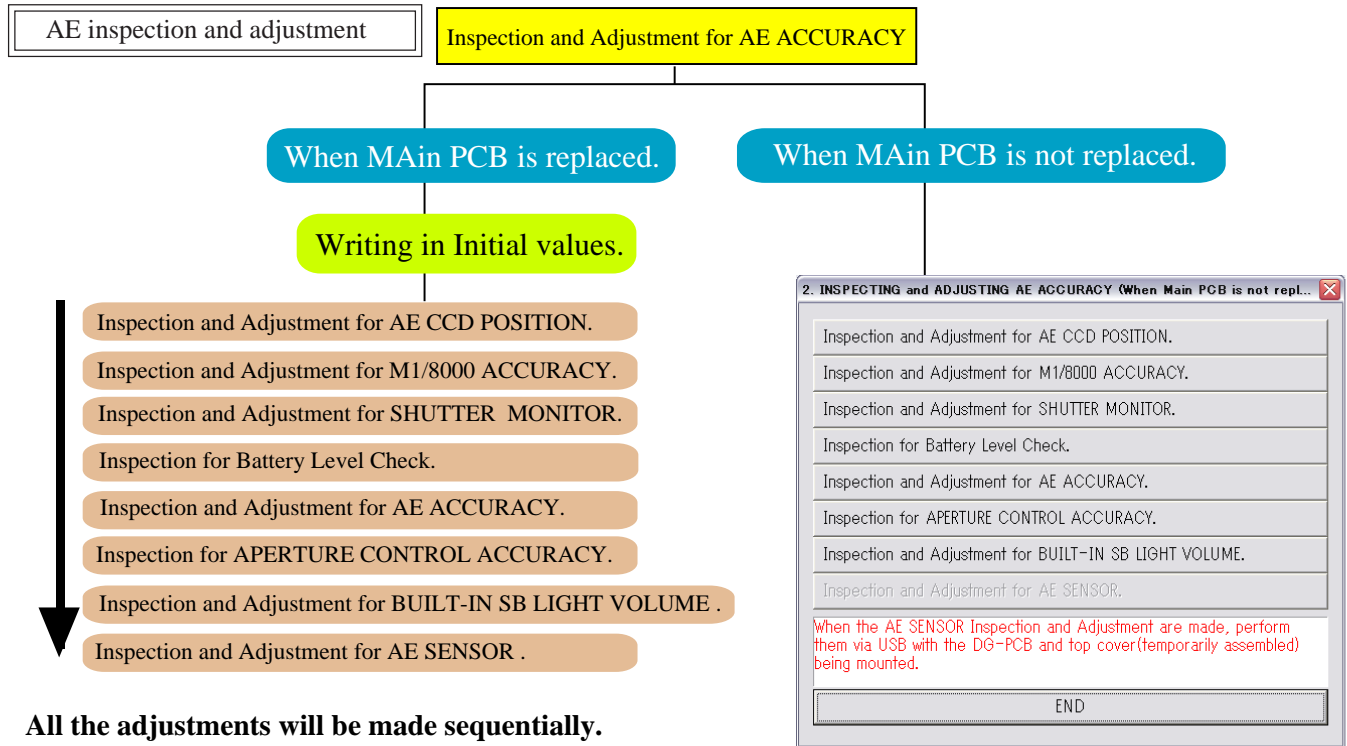

All the adjustments will be made sequentially.

Select adjustment items individually.

Caution: When the main PCB is replaced, after "writing of fixed value", update the firmware. Then, perform "writing of fixed value" again.

- ① AE-CCD positioning inspection/adjustment (For device and details, refer to Page A61.)
△ (Addition)
《RS232C or USB communication》
- ② Inspection of M1/8000 accuracy (For device and details, refer to Page A87.) 《RS232C communication》
- ③ Inspection/adjustment of Shutter monitor (For device and details, refer to Page A88.)
《RS232C communication》
- ④ Battery check voltage adjustment (For device and details, refer to Page A89.) 《RS232C communication》
- △ (Addition)
- ⑤ Inspection/adjustment of AE accuracy 《USB or RS232C communication》

Caution: Regarding AE accuracy, inspection is not made by using exposure value with shutter tester as seen in the traditional method. The metering value will appear on PC screen.

Whenever the metering FPC unit is disassembled/replaced or the main PCB is replaced, make this adjustment.

Device	J19123	J18267	
	SHUTTER TESTER EF-1(CE)	AF50/1.4D LENS AF50/1.4D	AF28/2.8D LENS AF28/2.8D
	AF70-300/4.5.6D OR AF-SVR70-300/4.5-5.6 LENS AF70-300/4.5.6D OR LENS AF-SVR70-300/4.5-5.6		



△ (Addition)

⑥ Aperture accuracy inspection 《USB or RS232C communication》

Caution: Whenever the I PCB is replaced, or the main PCB is replaced, make this adjustment.

<u>Device</u>	 J19123 SHUTTER TESTER EF-1(CE)	 J18267 AF50/1.4D LENS AF50/1.4D
---------------	--	--

△ (Addition)

⑦ Inspection and adjustment of built-in SB light quantity 《USB or RS232C communication》

Set the distance between the camera and flash meter to 1m. Then, the built-in SB light quantity is inspected and adjusted.



<u>Device</u>	 FLASH METER	 J18360 Standard reflector 1.5M × 1.5M
---------------	---	---

⑧ Inspection and adjustment of AE sensor 《USB communication》

Caution: Whenever the shutter unit is disassembled/replaced or the main PCB is replaced, make this adjustment.

When performing "obtain of AE sensor reference value", set the metering mode to "Multi-pattern". △ (Revision)

For AE sensor reference value, copy the D3 data file "D3SEEN.DAT" into the folder and use it.

<u>Device</u>	 J19123 SHUTTER TESTER EF-1(CE)	 AF50/1.4D LENS AF50/1.4D
---------------	--	---

AF inspection and adjustment

Caution: When this adjustment software is used for the first time, prepare three D700 cameras, and measure by "Writing of AF adj. lens offset value" on the main menu.

① AF accuracy adjustment (All the adjustments items will be made in order.)

Caution: Whenever the AF sensor unit is disassembled/replaced or the main PCB is replaced, make this adjustment.

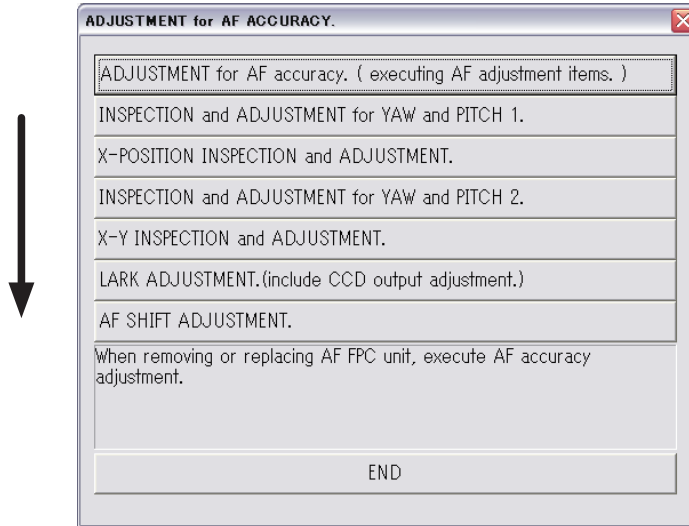

△ (Addition)

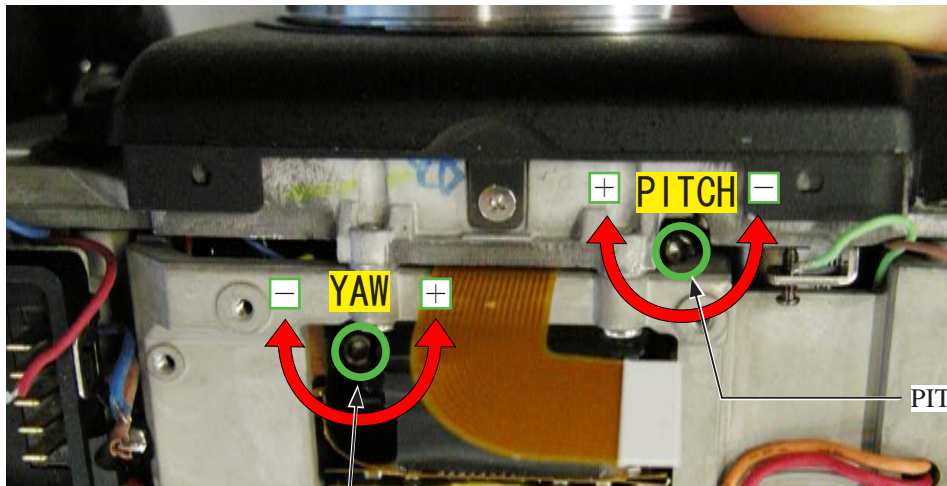

② YAW, PITCH inspection and adjustment 《USB or RS232C communication》



YAW adjusting screw

※ The reference screw is fixed with E ring.

Device

 J19123 SHUTTER TESTER EF-1(CE)	 J18230 YAW · PITCH ADJUSTMENT TOOL
--	--

△ (Addition)

③ X / Y inspection and adjustment 《USB or RS232C communication》



Caution : Whenever the AF sensor unit is disassembled/replaced or the penta-prism unit is disassembled or the mirror angle is adjusted, be sure to make this adjustment.

【Procedure】

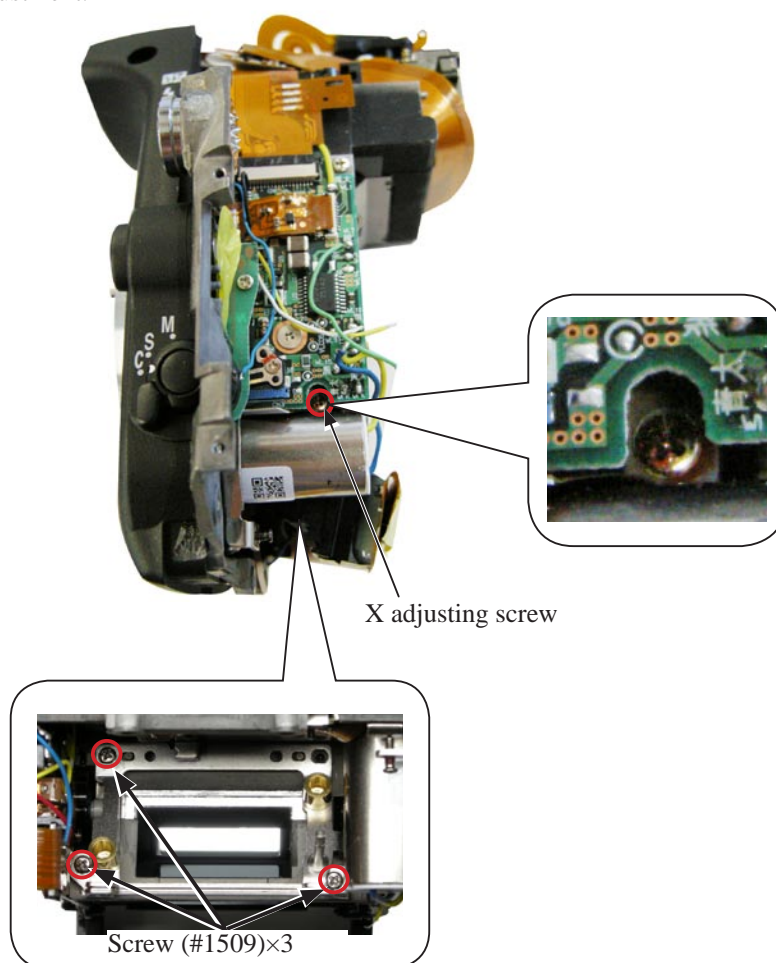
1. .Set the X chart.
2. Read the degree of rotation of the X-adjustment screw by the X-position inspection & adjustment.
3. Remove the front body, and loosen the three screws that fix the mounting plate.
4. Turn the X-adjustment screw through the degree of rotation which was read by ② ,then, apply the screwlock to this screw.
5. Tighten the three screws to fix the mounting plate.
6. Mount the front body (#1509) on the rear body temporarily. Repeat the procedure from 2. to 5. until the result becomes within standard. (Usually, the result meets the standard only once.)
7. When the adjustment is completed at 6, make the YAW/PITCH inspection & adjustment .
8. Make the XY inspection and adjustment.



Device

 J19123 SHUTTER TESTER EF-1(CE)	 J63098 AF X-Y CHART FOR D3
--	--



④ LARK adjustment (incl. CCD output adjustment) 《USB or RS232C communication》

Device

 <p>J63070</p> <p>COLOR VIEWER</p>	 <p>J18267</p> <p>LENS AF50/1.4D</p>	 <p>J15280</p> <p>LENS HOLDER</p>
 <p>J15259</p> <p>AF ADJUSTING TOOL</p>	 <p>J18266</p> <p>Z ADJUSTMENT LENS (FOR 1m)</p>	 <p>J15264</p> <p>ILLUMINATION BOX FOR AF ADJUSTMENT</p>
 <p>J15407</p> <p>MULTI CAM 2000 AF CHART</p>		

⑤ AF shift adjustment 《USB or RS232C communication》

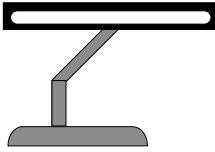
Device

 <p>J18393</p> <p>SLANT CHART</p>	 <p>J19124</p> <p>Z-light</p>	 <p>J18267</p> <p>LENS AF50/1.4D</p>
--	---	---

⑥ CONFIRMING the DATA

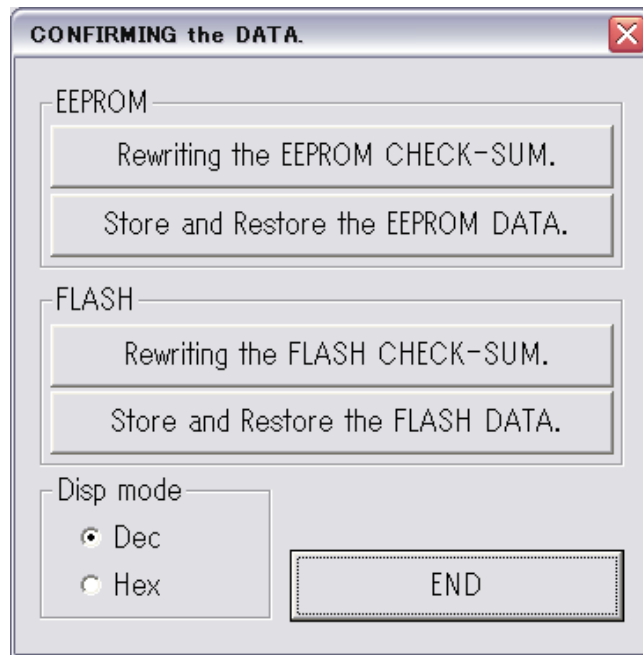

• Rewriting the EEPROM/FLASH CHECK-SUM

In case error is displayed on camera because of error in checksum (i.e. function for checking whether the data is put in the memory at last after writing the data), "Rewriting the EEPROM CHECK-SUM." is performed for both EEPROM and FLASH, and recover to normal state from checksum error. However, even if "Rewriting the CHECK-SUM" is performed, be sure to make readjustment.

• Store and Restore the EEPROM/FLASH DATA

The save-restore function is a for sending backup data for analysis to Service Planning in case some troubles occur. The data storage space of camera section (excluding imaging section) is divided into FLASH ROM system area and EEPROM system area. The details are as follows:

FLASH ROM
system area
(Low frequency of
rewriting data)

Fixed value, adjustment
value, etc.

EEPROM system area
(High frequency of rewriting
data)

No. of times for releasing shut-
ter, error history, custom menu
setting, etc.

⑦ INSPECTION for SEQUENCE ERROR

Records (history) of errors which happened to camera can be confirmed. They will be shown as "Latest error, HIST 1, HIST 2 . . .
" in order, and the further previous records will be shown in trouble history. (EXIST, NON only)

INSPECTION for SEQUENCE ERROR

ERROR HISTORY

Latest error: NON

HIST 1: 20[Hex] RLS_IR_ERR HIST 4: 22[Hex] SOMETHING ERROR

HIST 2: 28[Hex] SOMETHING ERROR HIST 5: NON

HIST 3: 43[Hex] RLS_CHGTIMEOUT3

HISTORY of ACCIDENT

Mirror-up:	<input type="button" value="EXIST"/>	Shutter:	<input type="button" value="EXIST"/>
IR ctrl:	<input type="button" value="EXIST"/>	Shutter monitor:	<input type="button" value="EXIST"/>
Electro IR:	<input type="button" value="EXIST"/>	Charge:	<input type="button" value="EXIST"/>
IR Mechanic:	<input type="button" value="EXIST"/>	Initial position:	<input type="button" value="EXIST"/>

Adjustments on PC required when parts are replaced

(Camera)

	Writing of fixed value	AE CCD positioning	Shutter M1/8000	Shutter monitor	Battery check	AE accuracy	Aperture accuracy	Built-in SB adj. and insp.	* 3 AE sensor insp. and adj.	AF accuracy
Shutter unit			○	○					△ (Addition) ○	
Main PCB	* 1 ○	* 2 △	○	○	○	○	○	○	○	○
AF sensor unit										○
DC/DC										
Metering FPC unit		○				○			○	
I PCB							○			

* 1: Whenever the main PCB is replaced, update the firmware after "writing of fixed value", and then perform "writing of fixed value" again.

* 2: Make the inspection.

* 3: Whenever "AE sensor inspection and adjustment" is made, assemble up to the stage of DG-PCB unit, and make the inspection and adjustment via USB.

Back cover unit/CF cover unit

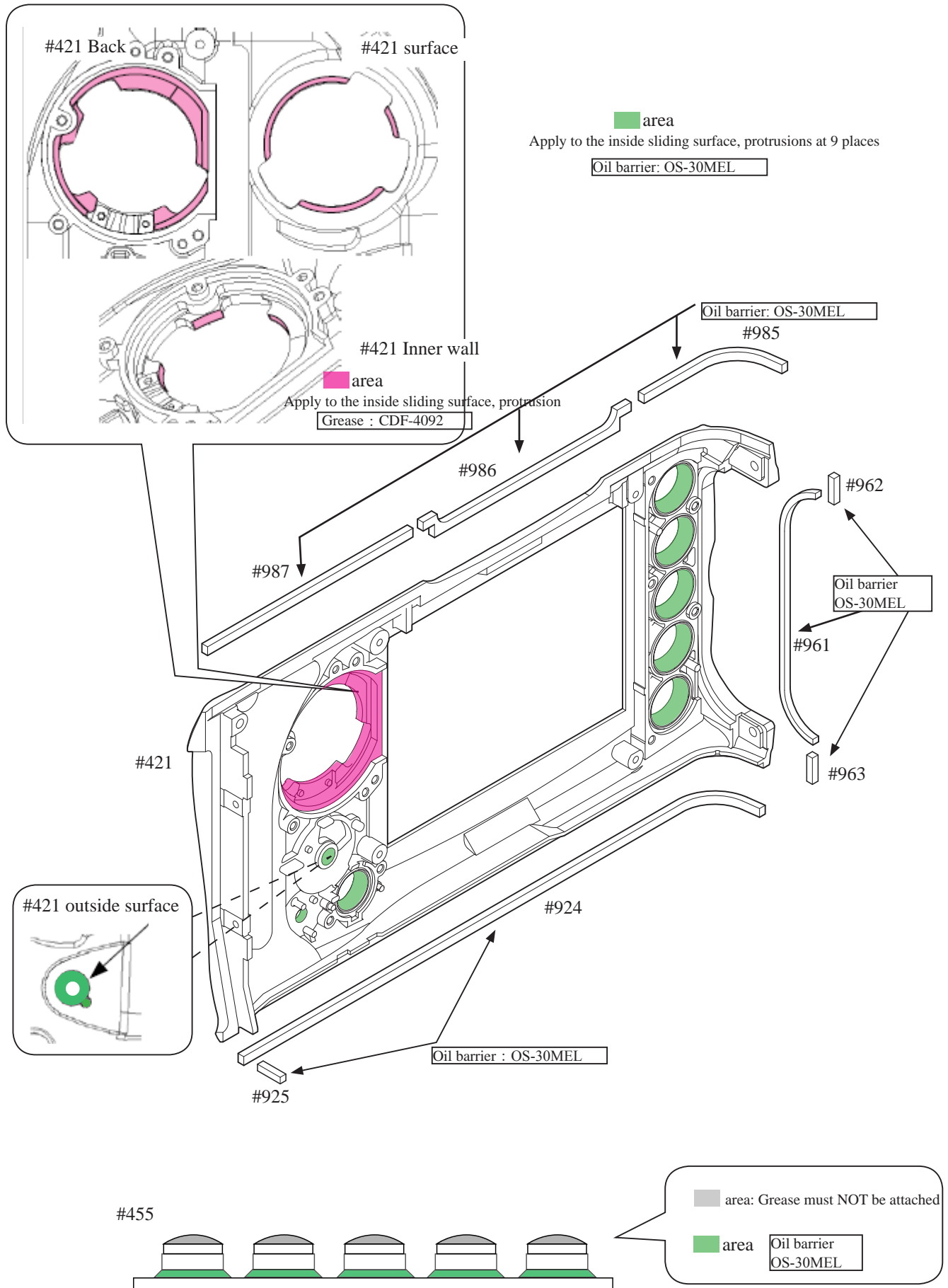

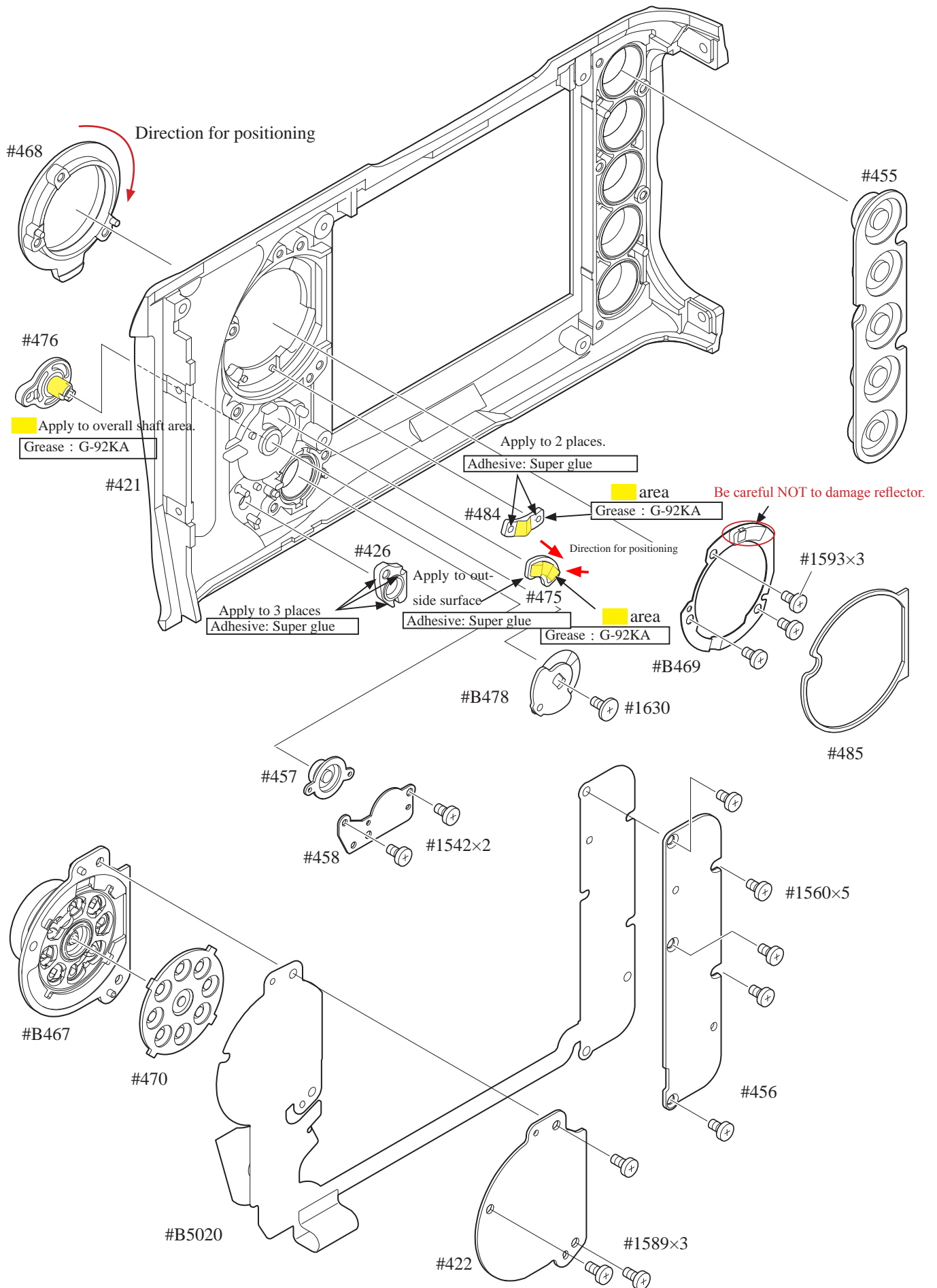

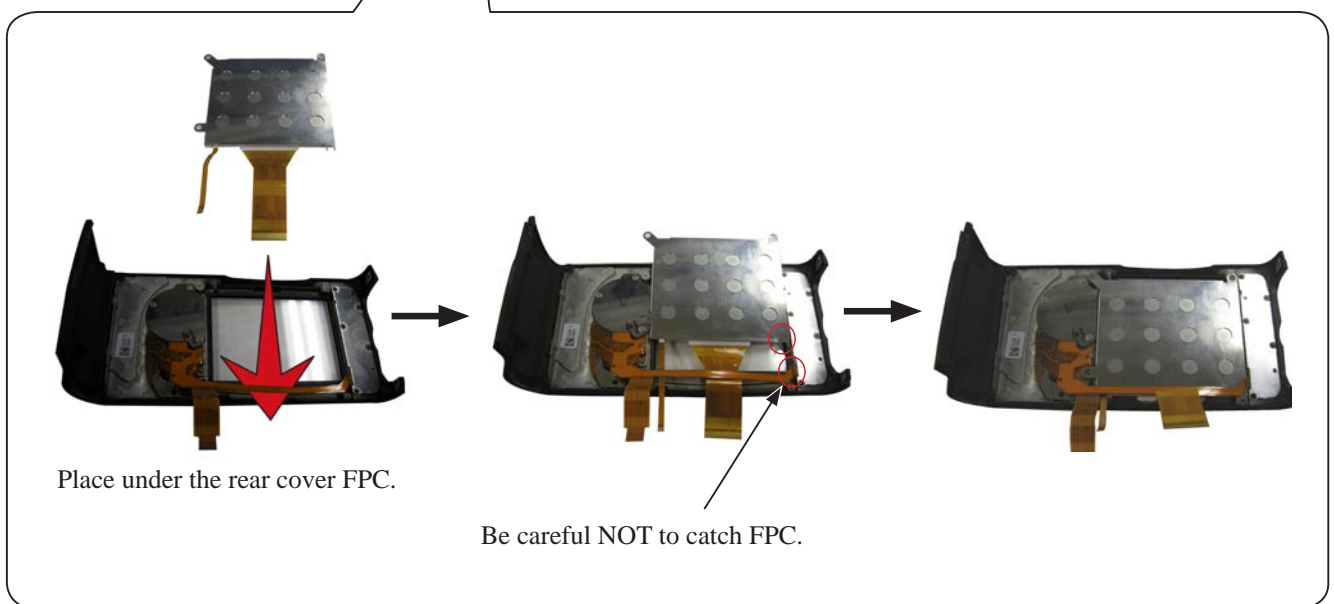
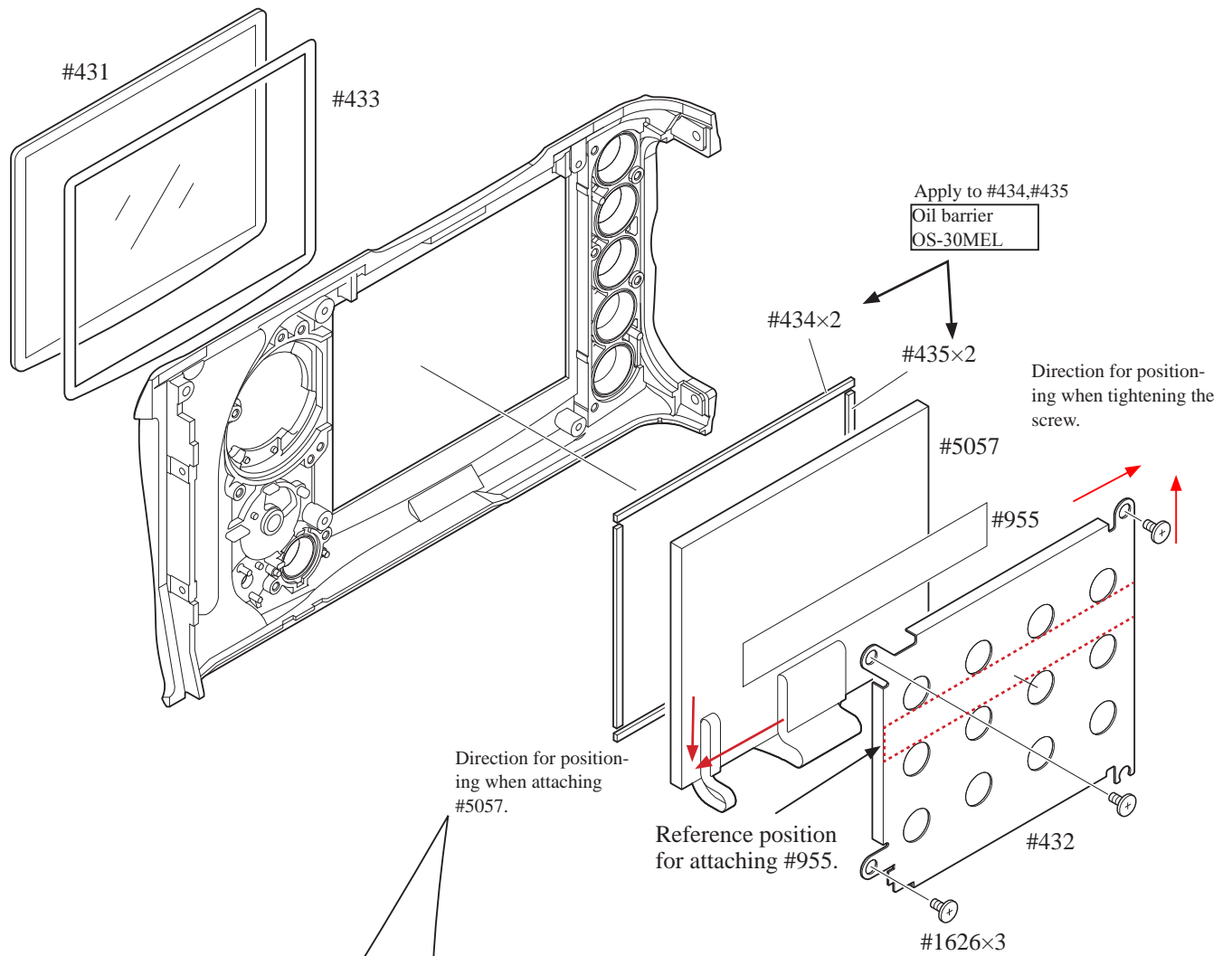

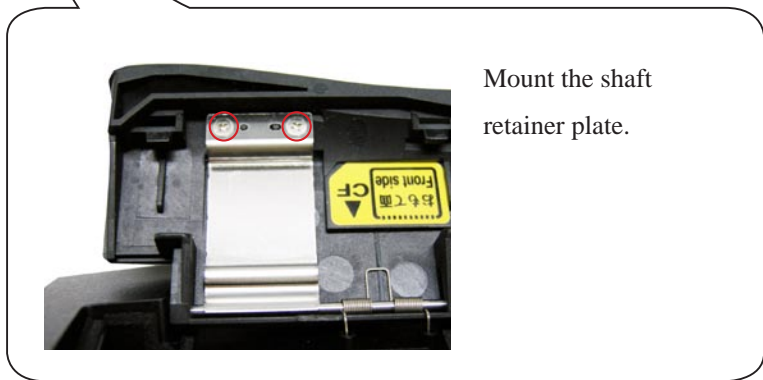
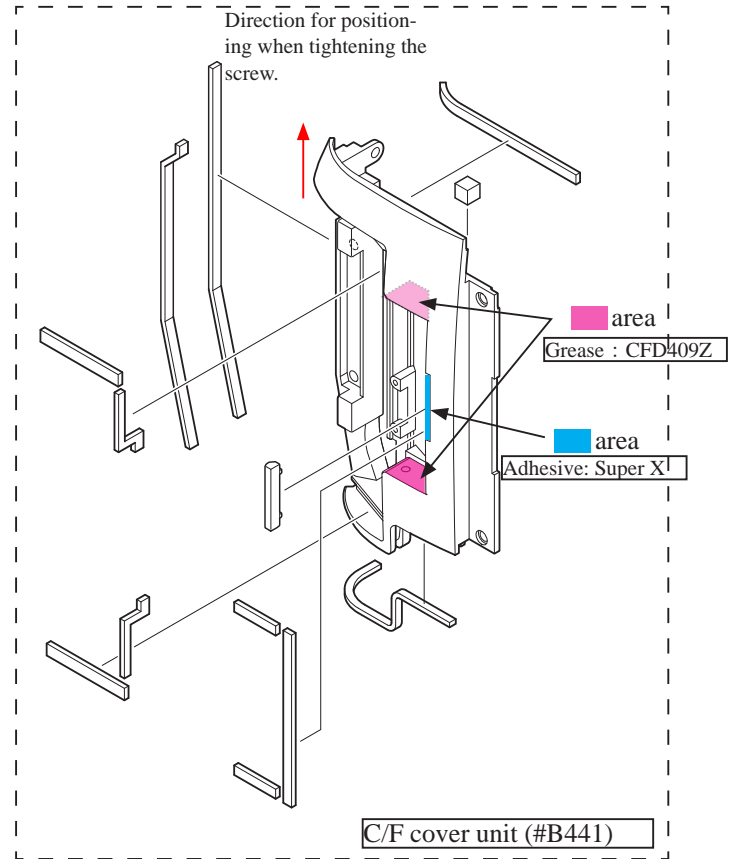
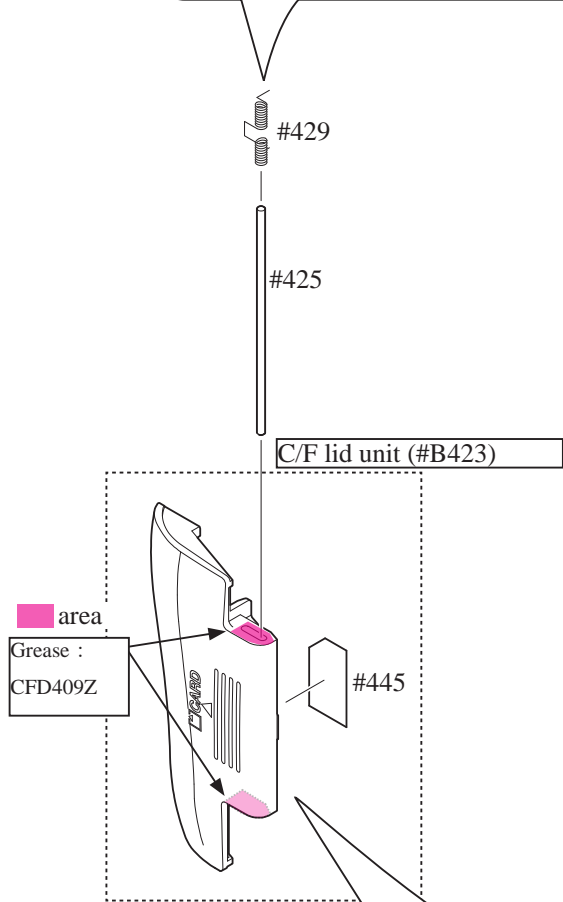
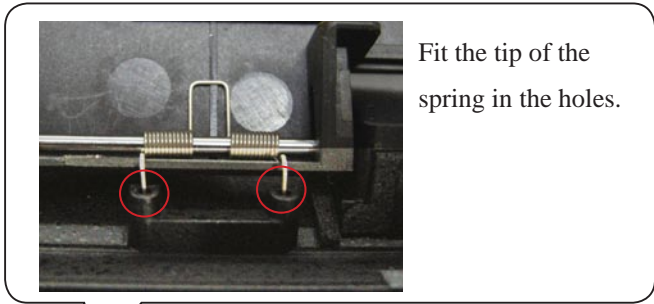

- Attach the CF cover unit (#B441) to the back cover unit (#B421RP).



- Tighten the two screws (#1518).

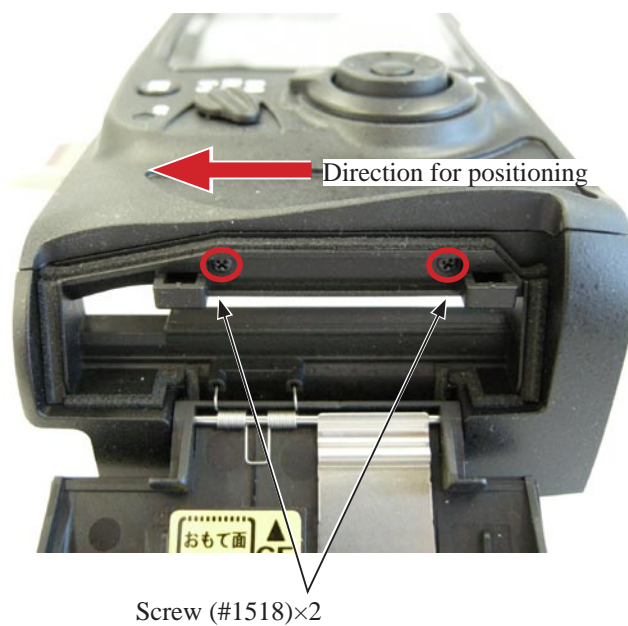

Mounting of Back cover

- Connect the three FPCs.

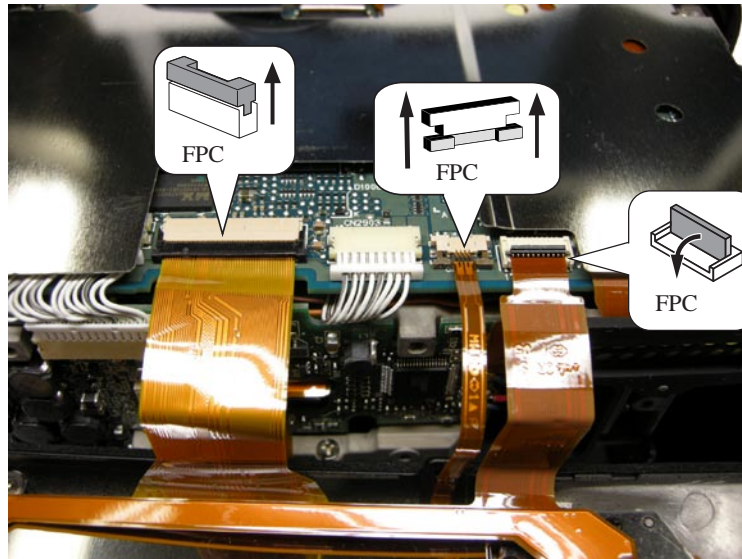

- Mount the back cover.

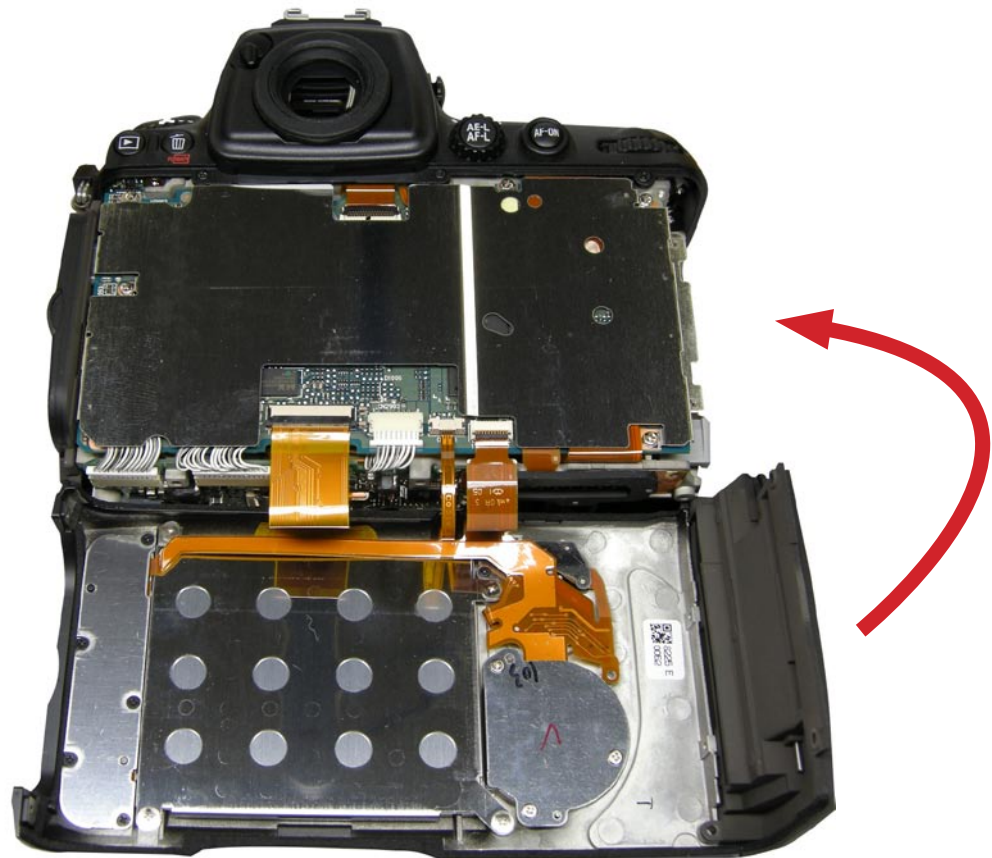

- For easy mounting, first ① set the CF card side, and then ② the IF cover side.



- Tighten the two screws (#1529) in the order from ① to ② .



Screw (#1529)×2

- Tighten the screw (#1551).



- Tighten the two screws (#1545) in the order from ① to ② .

Caution: △ (Addition)
In case the length of the screw is different
between ① and ② , use the longer one for ① .

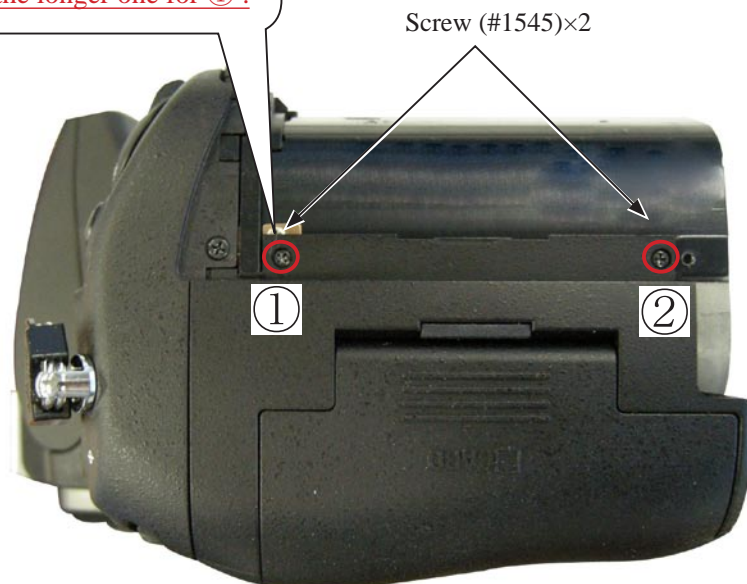

Bottom cover

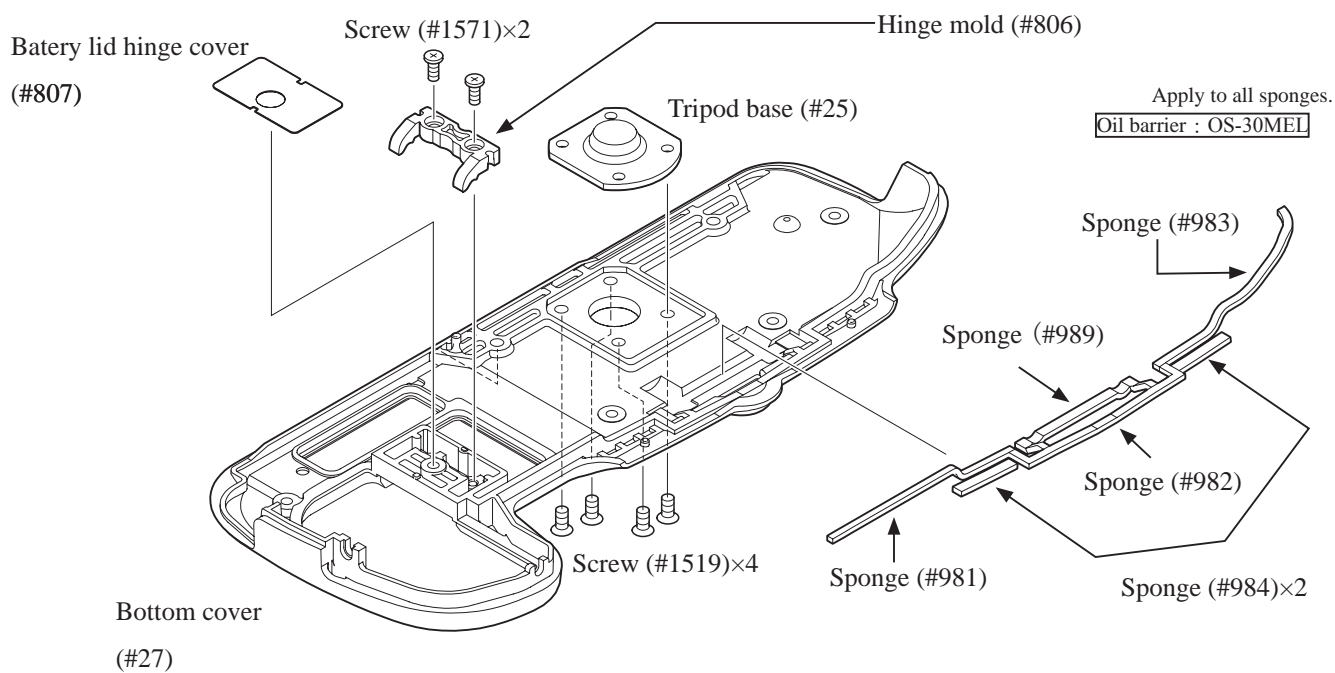

- Tighten the two screws (#1528) in the order from ① to ② .
- Tighten the two screws (#1529) in the order from ③ to ④ .
- Tighten the three screws (#1517) in the order from ⑤ to ⑦ .

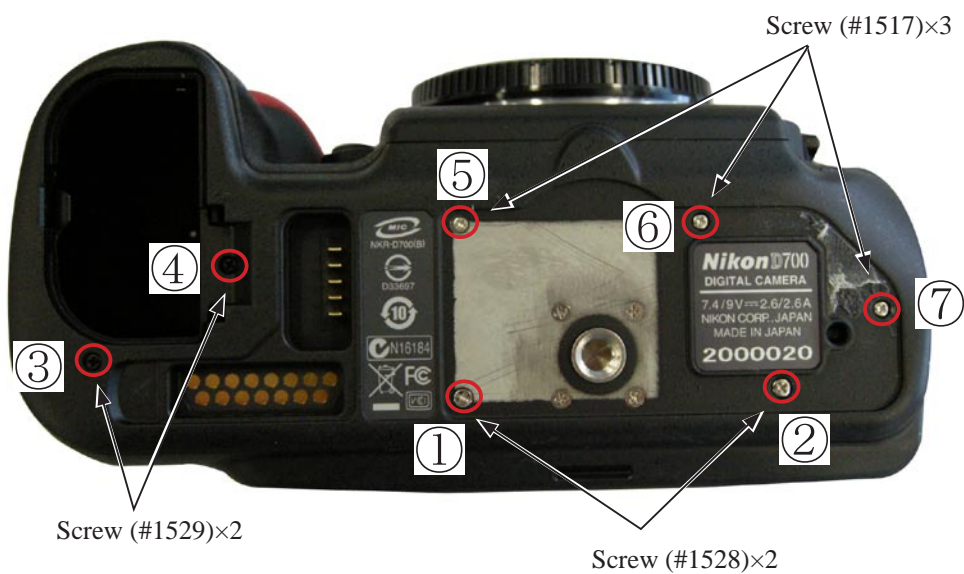

- Tighten the screw (#1509).
- Attach the double-stick tape (#883).

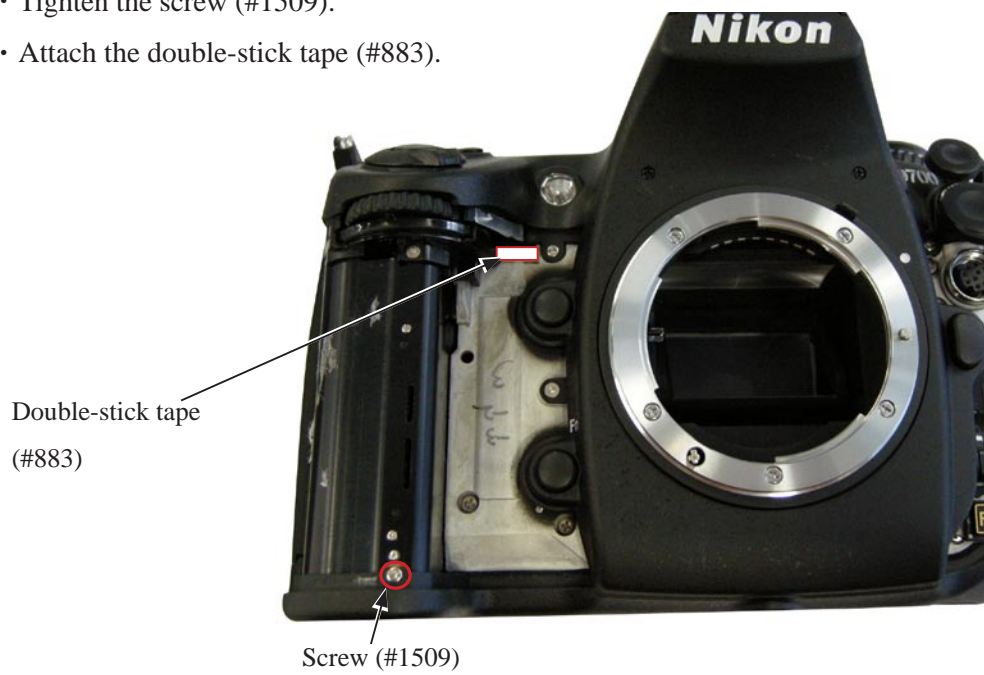

- Tighten the screw (#1509).



Battery lid

- Mount the battery lid unit (#B801).

Mount from the side to avoid breaking the shaft.

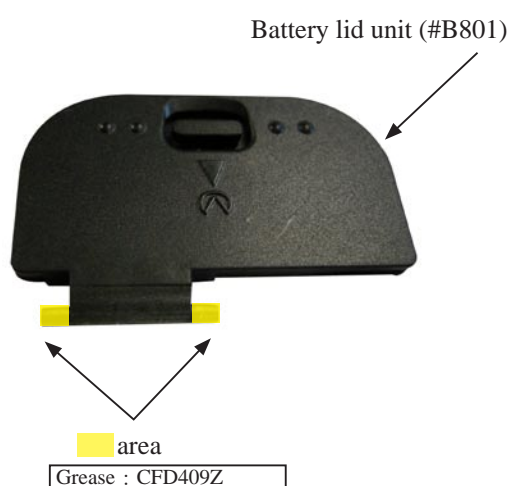

External rubber

- Attach the grip rubber unit (#B60).

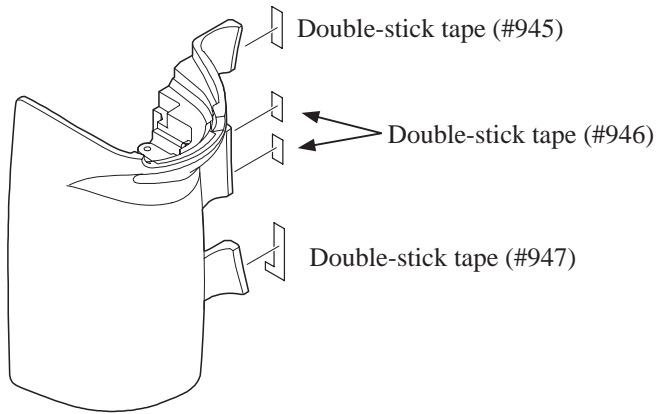

- Tighten the screw (#1647).

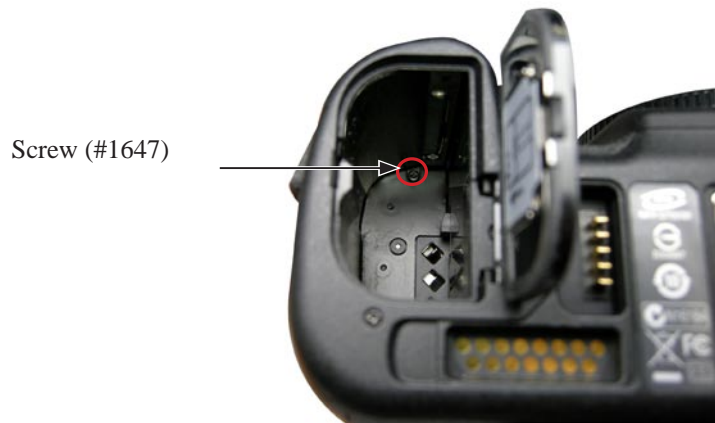

- I/F rubber unit (#B10061).

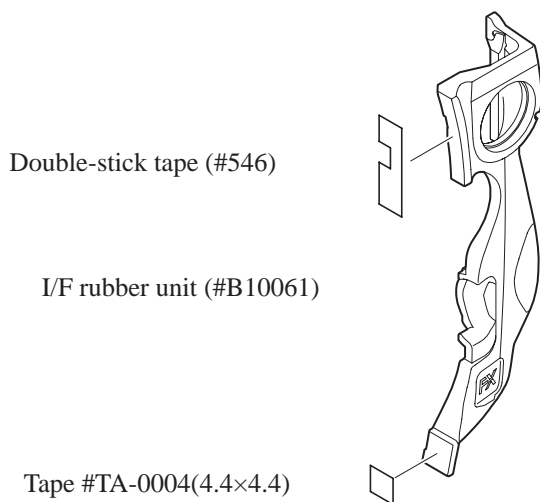

I/F rubber unit (#B10061)

- Attach the rear rubber unit (#B447).



- Attach the bottom cover unit (#B63).
- Attach the rubber cap (#68).



Shooting-image Adjustment

1. Summary

When the D700 shooting image-related and listed parts on Page A128 are replaced, be sure to make this adjustment by the shooting image adjustment software for D700 (J65120).

Use the D3 reference body beforehand, and get the reference value. Getting reference value will create the reference data "D700BSD.DAT" automatically.

Make all of the adjustment items in numeric order. They are programmed to perform continuously, so when one item is completed, the software automatically moves on to the next item.

If the adjustment is interrupted by "NG", the adjustment item can be restarted halfway from the "NG" item, and the adjustment of items which ended with "OK" have been completed.

2. Adjustment software function

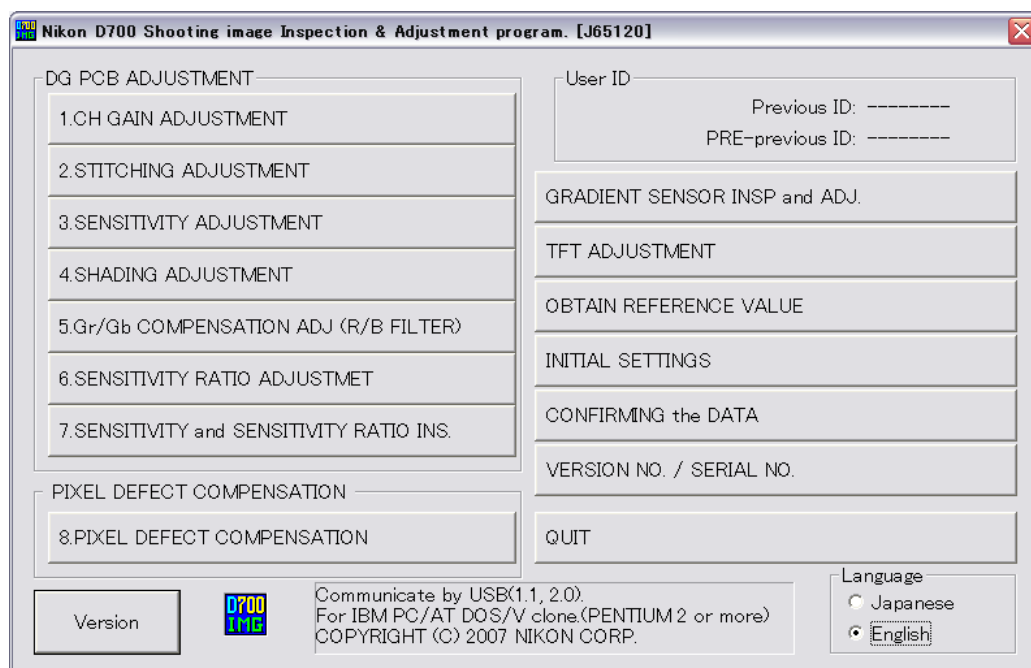

- (1) Gain difference adjustment among channels
 - (2) Stitching adjustment
 - (3) "Sensitivity" adjustment
 - (4) Shading adjustment
 - (5) Gr/Gb compensation adjustment (R/B filter) / Line crawl adjustment
 - (6) "Sensitivity ratio" adjustment
 - (7) "Sensitivity" / "Sensitivity ratio" adjustment
 - (8) Pixel defect compensation - black point
 - (9) Pixel defect compensation - white point
- Tilted sensor inspection & adjustment
- TFT adjustment
- Obtain reference value
- Initial settings (factory default settings)
- Confirm data
- Version No./ Serial No.

3. Hardware requirements

OS : Windows2000, WindowsXP, Windows VISTA
Japanese or English OS
PC : CPU Pentium II or more
Memory 256MB or more
USB1.1 or 2.0
Screen size: 1024×768 pixels or more

4. How to set up

Create "C:\DeskTopLauncher\D-SLR\D700IMGIMG" folder is created in the hard disc of PC, so copy "PD700IMG.EXE". This file is an self-extracting file, so decompress it in the created folder.

※ Be sure to copy the above file in the same directory. **Note that the adjustment can not be made except in the above folder.**

Adjustments on PC required when parts are replaced

(image)

	*3 Serial no. input	*3 QR code input	Gain diff. adj. among Chan- nels	Stitch- ing adj.	Sensi- tivity adj.	Shad- ing adj.	Gr/Gb comp. adj.	Sensi- tivity ratio	Sensi- tivity/ Sensi- tivity ratio adj.	Pixel defect comp.		Tilt sensor ins.adj.	TFT- adj.	Factory default setting	Ver. No/ Ser. No
										Black	White				
Main PCB															
DC/DC															
*1,*2 AE FPC unit															
DG-PCB *2	○	○	○	○	○	○	○	○	○	○	○	○	○	○	
Image sensor unit		○	○	○	○	○	○	○	○	○	○				
LCD monitor													○		
License sheet															○

- *1. When the DG-PCB unit is replaced, be sure to update the firmware before adjusting Image-related section.
- *2. When the DG-PCB unit or the image sensor holder unit is replaced, take a picture of the QR code area before assembly. Then when the adjustment is made, read the QR code with the barcode reader based on the image adjustment software, and input the data.
- *3. There is no menu screen, but when "Gain difference adjustment among channels" is performed, the serial number and QR code data can be input by selecting whether to replace the PCB/base plate or not.

Setting of two-dimensional barcode reader

- Insert the two-dimensional barcode reader into the USB terminal.
- Read the bar codes shown below.

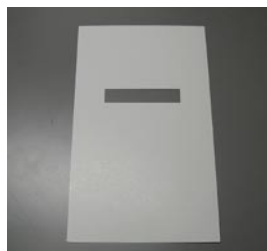

Reference:

To avoid reading errors, use a masking sheet of the left picture, which is supplied with a two dimensional barcode reader.

 ~ D E F A L T .	全デフォルト
 ~ T E R M I D .	ターミナル ID 設定開始
 ~ K 1 K	 USB バーチャル COM インターフェイス
 ~ K 3 K	
 ~ K 0 K	
 ~ M N U S A V .	ターミナル ID 設定終了

- After the reading, the dialog box that shows the new hardware is recognized will be displayed.
- Click "Next".

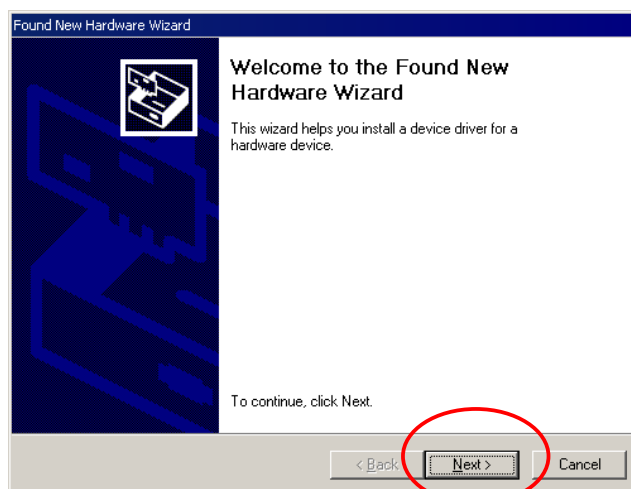

- Insert the CD-ROM which is supplied with a two-dimensional barcode reader into the PC.

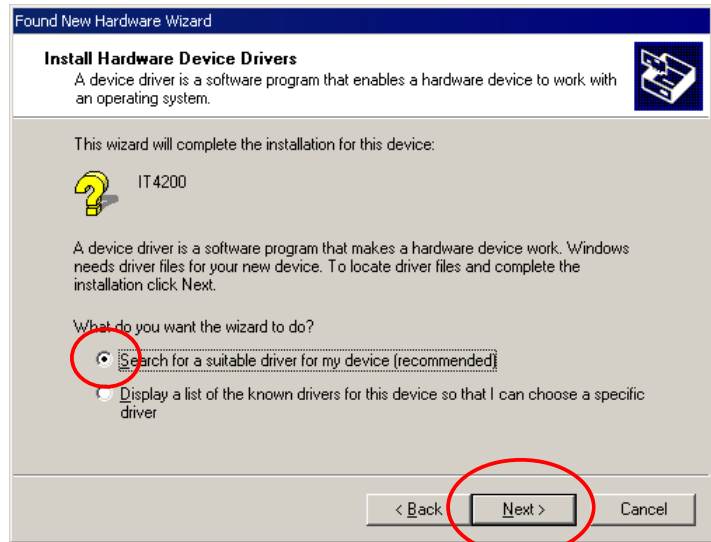

- Insert the CD-ROM which is attached to the two-dimensional bar code reader

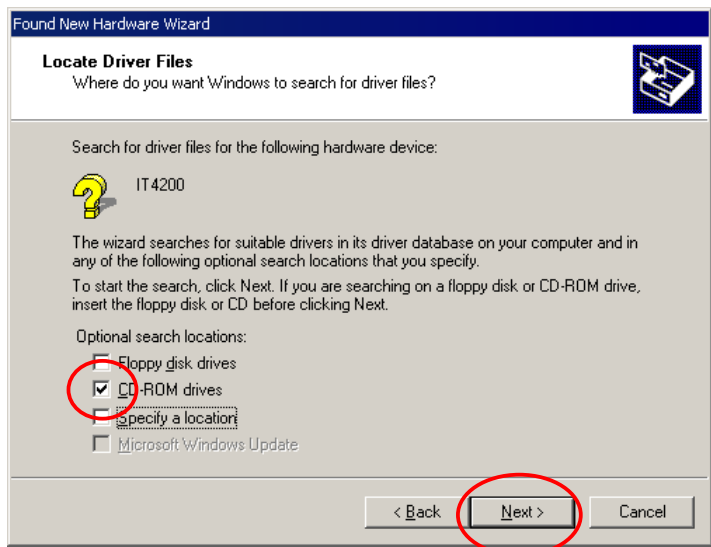

- Click "Finish" and take out the CD-ROM from the PC.

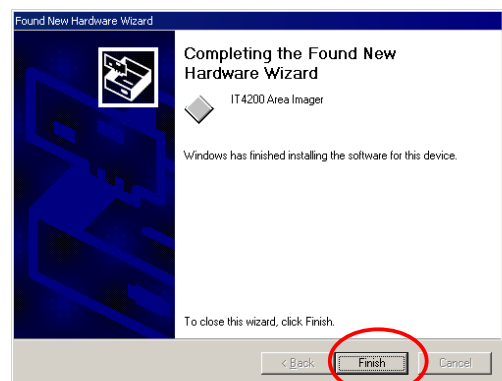
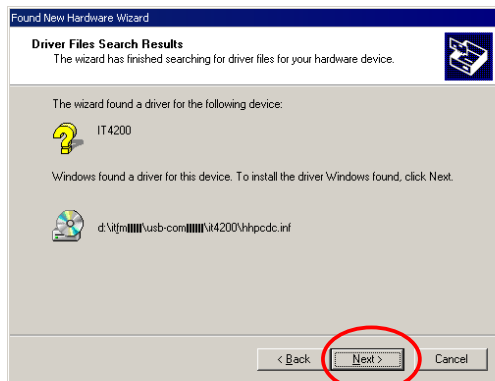

- Open "Device Manager" and confirm the port setting.
Click the right mouse button on "My Computer". Then, select the items in the following order:
[Properties] → [Hardware] → [Device Manager].

Note:The port setting differs depending on the PC environment.

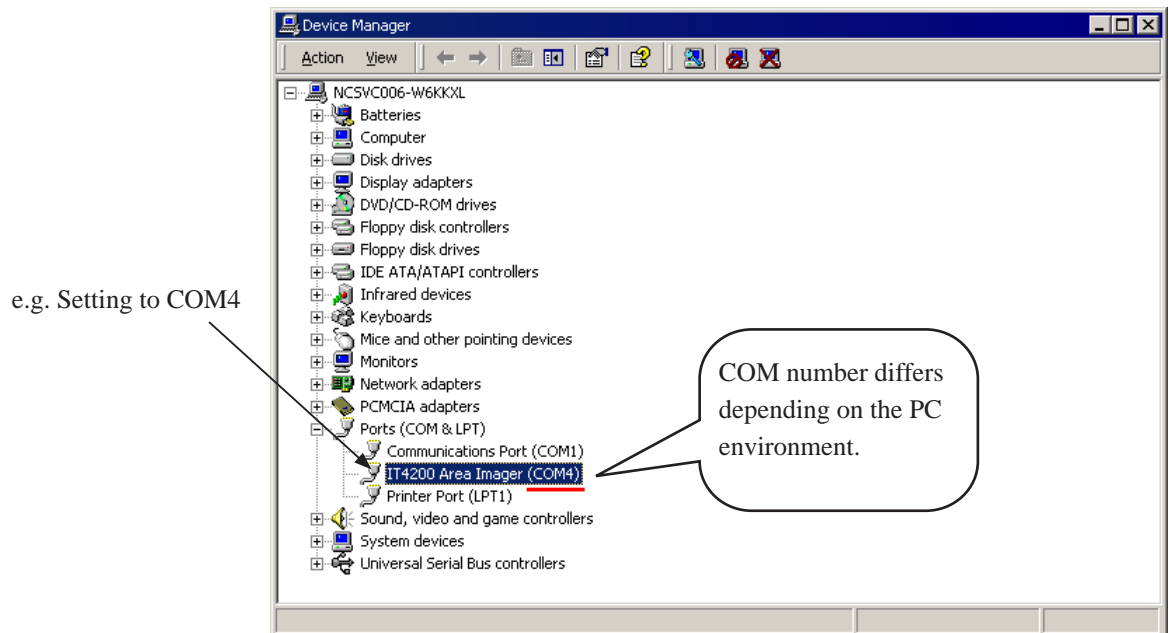

- Set the same port as confirmed by the device manager.

(1) Gain difference adjustment among Channels

Camera is faced to the color viewer (LV13 equiv.) with ND filter (-4 steps) being put between them. Change the adjustment gain value to even out variation among channels.

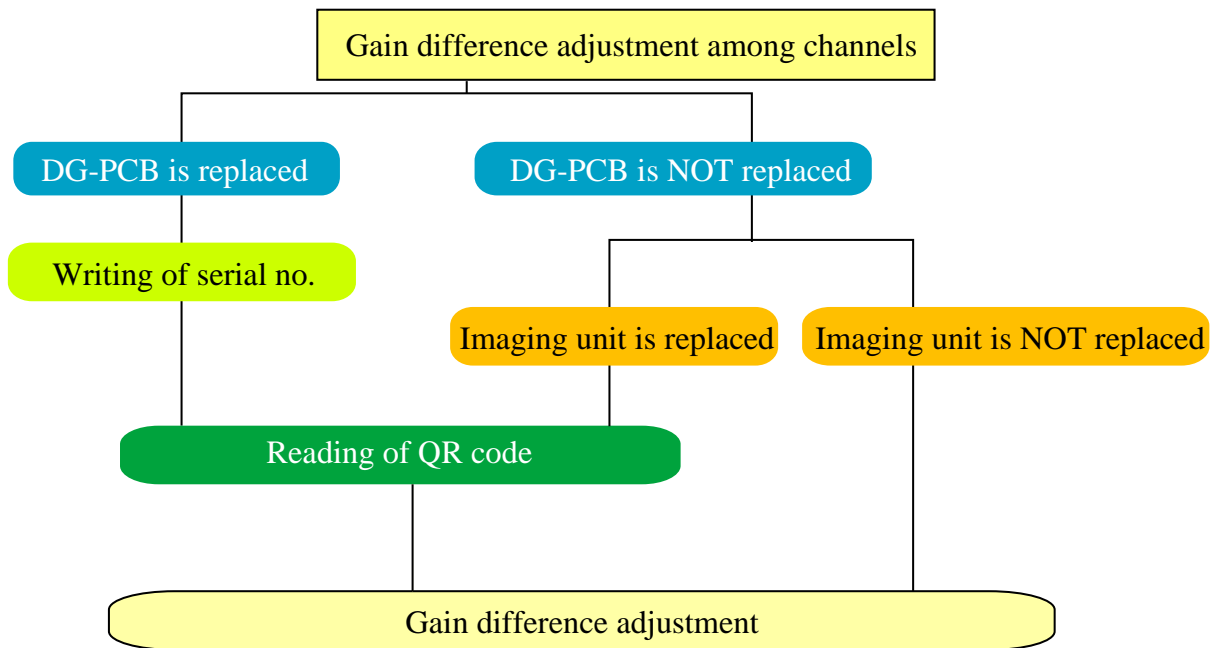

• When the DG-PCB or image-PCB is replaced:

With the QR barcode reader, read the bracket number of the image-PCB, and write the corresponding data into the DG-PCB. The data will be added every two weeks (e.g. "D700_0001.csv", "D700_0002.csv"...; "0001", "0002" means file number).
every Monday △ (Revision)

(ref. "TIE-8021-1" for details.) △ (Addition)

Device



 COLOR VIEWER	J63070	 TWO-DIMENSIONAL BARCODE READER	J61222	 ND FILTER 4X 2 pieces	J18358
 ND FILTER 8X 2 pieces	J18191	 DI STANDARD LENS	J61185		

(2) Stitching adjustment

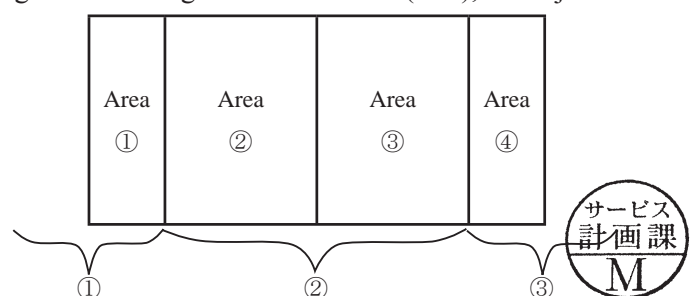
When the image pickup device is created, the stepper performs multi-zone exposure to create it, and this adjustment is made so as to even up a difference among zones. Using the shutter tester (L12), the adjustment is made with the tool lenses (F1.4 and F8).







Device

 J19123 SHUTTER TESTER EF-1(CE)	 J61185 D1 STANDARD LENS
--	--

(3) Sensitivity adjustment

Under condition of ISO200 and ISO800, the camera is faced to the color viewer (LV13 equiv.) with ND filter (-6 steps) being put between them. Using the tool lens (F5.6), the adjustment is made by changing the amp gain so that G output can fall in the standard range. The gain value is adjusted so that the G output average value (Average of Gr/Gb) of (425×425 pixels), which was deviated from the center by 425 pixels, can reach the target output level. By this sensitivity adjustment, the gain difference adjustment among channels is automatically made. Next, under condition of ISO6400, the camera is faced to the color viewer (LV13 equiv.) with ND filter (-8 steps) being put between them. Using the tool lens (F5.6), perform the same adjustment as the above.

Device

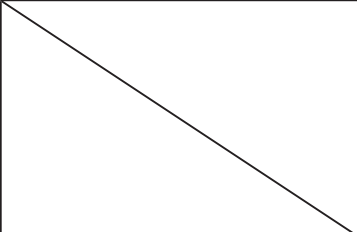
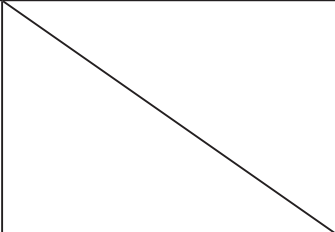

 J63070 COLOR VIEWER	 J61185 D1 STANDARD LENS	 J18358 ND FILTER 4X
 J18191 ND FILTER 8X 2 pieces		

(4) Shading adjustment

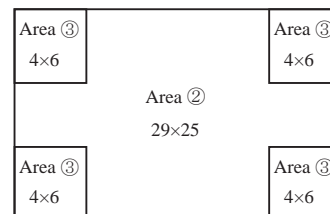
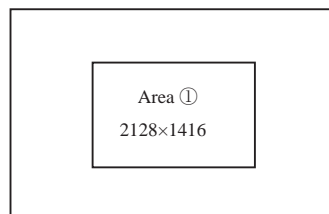
Using the shutter tester (LV12) and the tool lens (F8), the adjustment of white balance distribution is made for 3 areas [Area ① : Central 2128×1416-pixel area; Area ② : All the divided areas except ③ -areas after dividing (4266×2842-pixels) into (29×25-pixels); Area ③ ; 4 corners of (4×6-pixels) after dividing (4266×2842-pixel) into (29×25-pixels)].







Device

 J19123 SHUTTER TESTER EF-1(CE)	 J61185 D1 STANDARD LENS
--	--

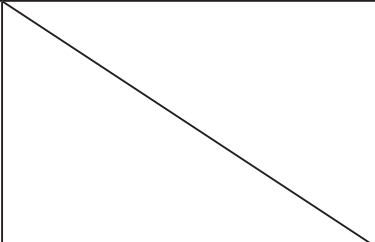
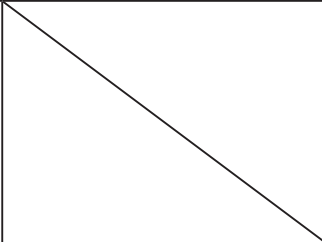

(5) Gr/Gb compensation adjustment (R/B filter) - Line crawl adjustment

Using the tool lens (F8), the camera is faced to- the shutter tester (LV12 equiv.) with SP3 (R filter) or SP1 (B filter) being put between them, and the adjustment is made so that the difference in G output average between B-G line and G-R line when the whole screen is divided in areas, can fall in the standard range.

<u>Device</u>	 J19123 SHUTTER TESTER EF-1(CE)	 J61185 D1 STANDARD LENS	 J63085 FILTER SP1
	 J63087 FILTER SP3		

(6)Sensitivity ratio adjustment

Using the shutter tester (LV9 equiv.) and tool lens (F5.6), the adjustment is made so that the R/G, B/G output becomes the same as the output ratio of the sensitivity ratio reference value that was calculated by the reference body. The adjustment is made only under the condition of ISO200, and the average value of (425 pixels × 425 pixels) which was deviated from the center by 425 pixels is used.

<u>Device</u>	 J19123 SHUTTER TESTER EF-1(CE)	 J61185 D1 STANDARD LENS
---------------	--	--

(7) Sensitivity/sensitivity ratio inspection

Using the color viewer (LV13 equiv.) and tool lens (F5.6), inspect whether a difference from the reference body is in the range of standards.

<u>Device</u>	 J63070 COLOR VIEWER	 J61185 D1 STANDARD LENS
---------------	---	--



(8) Pixel defect compensation - black point

Using the color viewer_ (LV13 equiv.) and tool lens (F5.6), pictures are taken. When pixels of which the output level is under specified value are detected, the coordinates of the detected pixels are additionally written as pixel defect compensation data.



(9) Pixel defect compensation - white point

Pictures are taken on the blackout surface (against dark background). In case the pixel output is found to be beyond the standard value, the detected pixel coordinates are additionally written as the pixel defect compensation data.



(10) Tilted sensor inspection & adjustment

This checks whether the indications of the virtual horizon display of the camera match the shot image, and make necessary adjustments.



SETUP

- ① Place the tilted sensor checking chart so that the chart line becomes vertical by using weighted string, etc.
[Enlarge a A4 (size) chart of the repair manual with a copier to become A3 (size), and use it.]
- ② Attach the AF50/1.4D lens to the camera. Set AF mode to "M", focus ring to "0.7m".
- ③ Set the camera in front of the chart approx. 0.7m-distance away.
- ④ Check the virtual horizon display, and place the camera at the horizontal position.
Make the inspection by start button, while make the adjustment by adjustment button.
(Angle offset standard: from "-1 deg." to "+1 deg.)

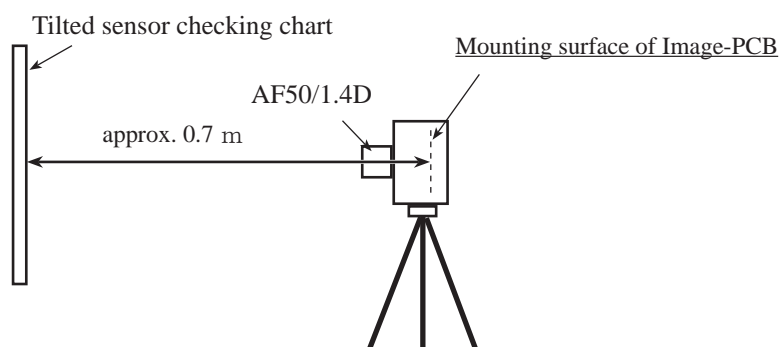
※ Green letters mean "up to standard", while red means "NOT up to standard)

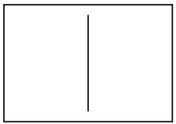

Device

 Tilted sensor checking chart	J18267  AF50/1.4D LENS AF50/1.4D
---	---

(11) TFT adjustment

Flickering, color and luminance of TFT are adjusted.

※ Whenever the DG-PCB or TFT monitor are replaced, be sure to perform "WRITING THE TFT FIXED VALUE."

Hue adjustment

Usually default value is set and adjustment is not necessary.

If some problem is found with hue by visual check, adjust and correct it by "+/-" button.

Brightness adjustment

Usually default value is set and adjustment is not necessary.



If some problem is found with brightness by visual check, adjust and correct it by "+/-" button.

(12) Obtain reference value

• Sensitivity reference value calculation

On condition of ISO200, using the tool lens (F5.6), the reference body is faced to the color viewer (LV13 equiv.) with the ND filter (-6 step) being put between them. Then, the G output average value of (425 pixels × 425 pixels), which was deviated from the center by 425 pixels, is stored in the D700BSD.DAT file as the sensitivity reference value.

Device

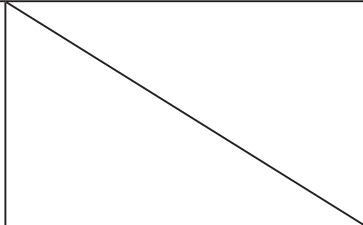
 J61229 D3 TOOL BODY	 J63070 COLOR VIEWER	 J19123 SHUTTER TESTER EF-1(CE)
 J61185 D1 STANDARD LENS	 J18191 ND FILTER 8X 2 pieces	

• Sensitivity ratio reference value calculation

Using the tool lens (F5.6), the reference body is faced to the shutter tester (LV 9 equiv.). Then, the sensitivity ratio reference value GR and GB are calculated and stored in the D700BSD.DAT file, based on the G/R/B output average of (425 pixels × 425 pixels), which is deviated from the center by 425 pixels.

• Sensitivity/sensitivity ratio reference value calculation

Using the tool lens (F5.6), the reference body is faced to the color viewer (LV 13 equiv.). Then, measure the level of sensitivity and sensitivity ratio, and the result is stored in the D700BSD.DAT file.

It is necessary to calculate the reference values in order to prevent the color temperature fluctuation caused by the shutter tester or color viewer's changes over time from affecting the results of the shooting image adjustment. By using the reference body, calculate the reference values once in about every 3 months, when either of the fluorescent of the color viewer or tool lens (F5.6) or ND filter (ND8X2) is replaced.

(13) Initial settings (Factory default settings)

This restores factory default settings. Select the language and video mode. Because this setting of RP DG-PCB is blank, be sure to set the initial default setting when the DG-PCB is replaced.

(14) Confirm data

Saving/restoring of the system fixed values, image register, TFT register, EEPROM1, 2, 3.

The functions of saving/restoring each data is for sending backup data to Service Planning for analysis, if some problem occurs.

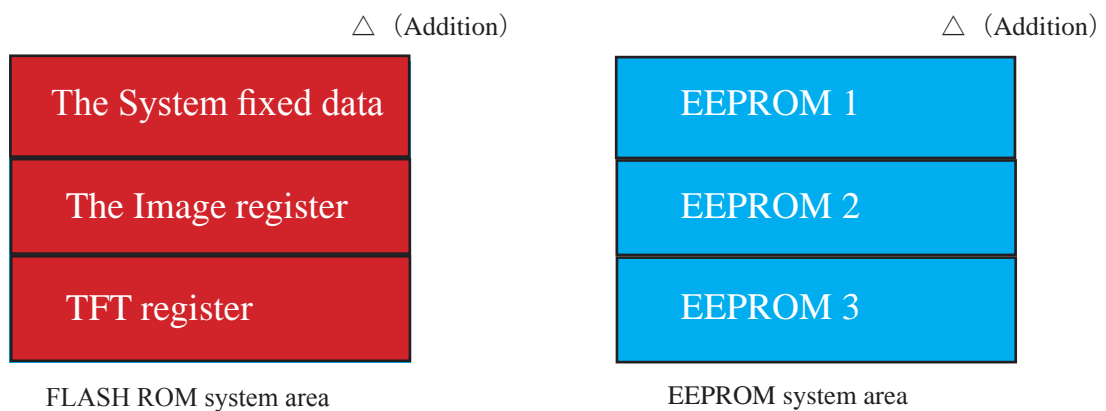

△ (Addition)

Image data storage space is divided into FLASH ROM system area (system fixed value, image register, and TFT register) and EEPROM system area (EEPROM 1, EEPROM 2, and EEPROM 3). But the data itself is related with each other in a complicated way, so in case of saving/restoring data, be sure to back up all the data as a set without fail.

(15) Version No./ Serial No.

RISC firmware version and serial number are indicated. Serial number can be written.

※ Whenever the license sheet is replaced, be sure to input the serial number.



∞ Infinity focus inspection & adjustment

- Replace the finder screen with the infinity focus check screen (J15432), and use the reference lens (J18010) and read the value. In case it is out of standard, increase or decrease washers (#1180A, #1180B, #1180C or #1180D) for adjustments. * Supply the power (Battery or EH-5) for checking.

Caution: When [J15432] is put in to replace the finder screen, put it with the silver spacers upward, which are attached on both sides.

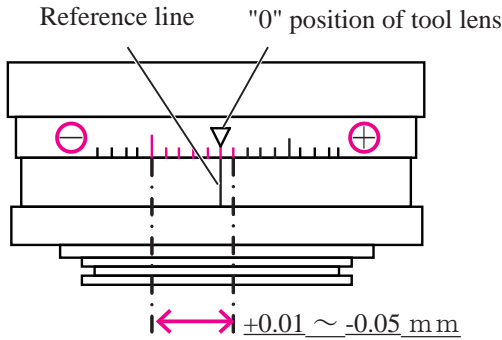

J18010



Standard: +0.01 ~ -0.05mm 1 scale = 0.01mm)

#1180A	1K608-832	Screen washer	A	0.10mm
#1180B	1K608-833	Screen washer	B	0.20 mm
#1180C	1K602-840	Screen washer	C	0.15mm
#1180D	1K608-977	Screen washer	D	0.05mm

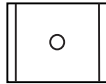
Device

 J19001 COLLIMATOR F=600mm	 J15432 FOCUS SCREEN FOR D700	 J18010 INFINITY STANDARD LENS 50/1.8
---	--	--



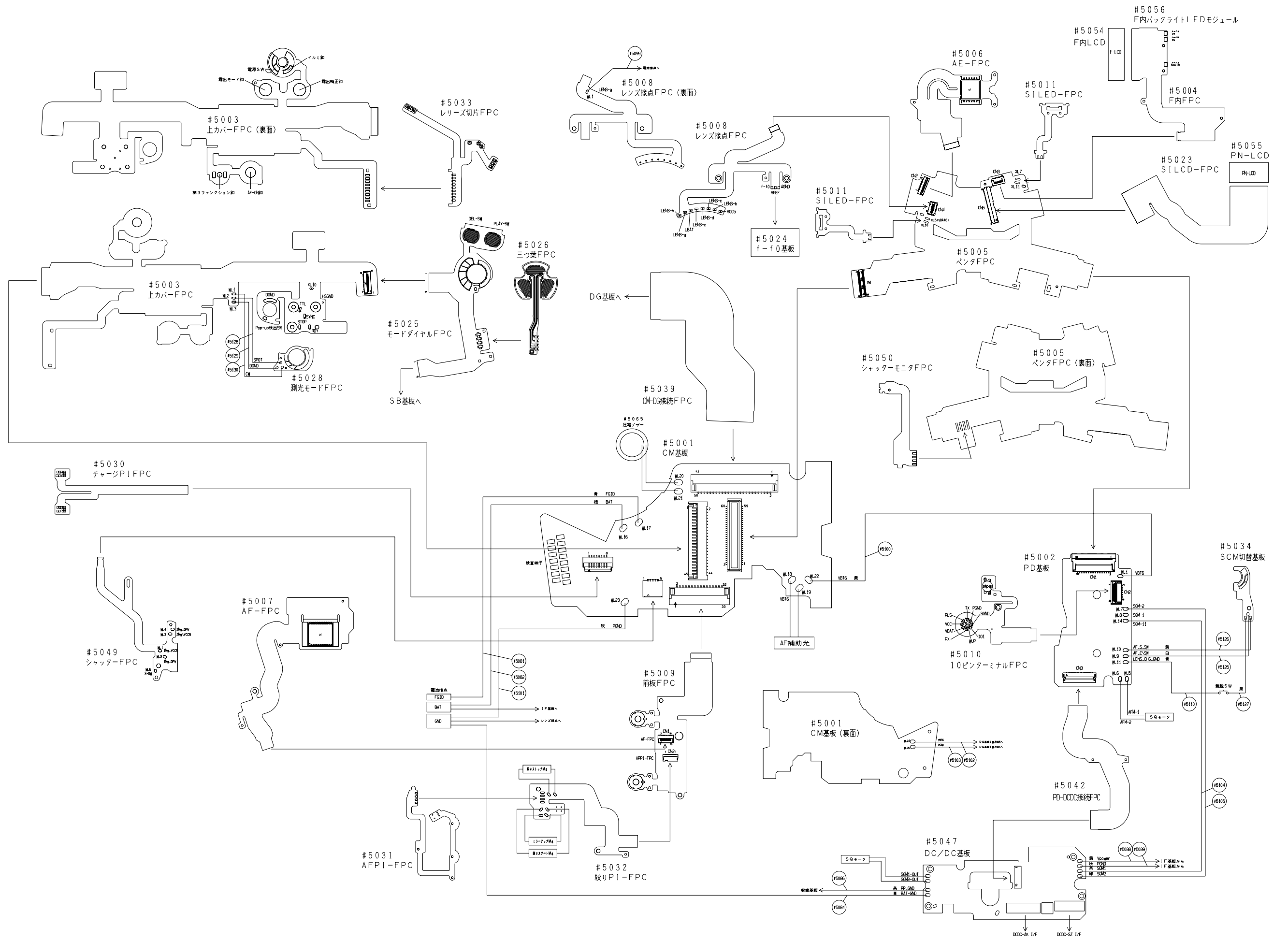

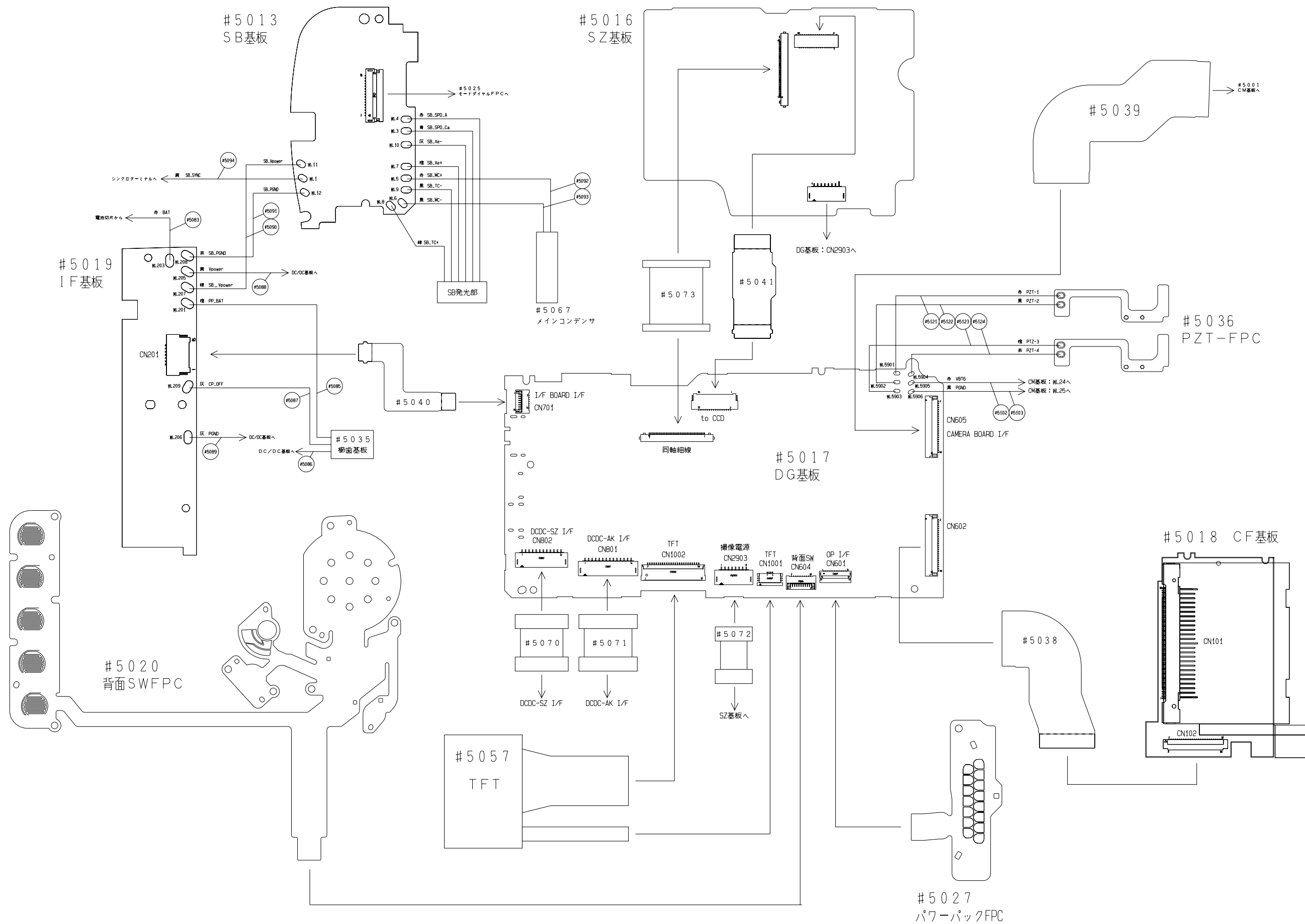

VBA22001-R. 3754. A

メイン基板

MAIN BASE PLATE

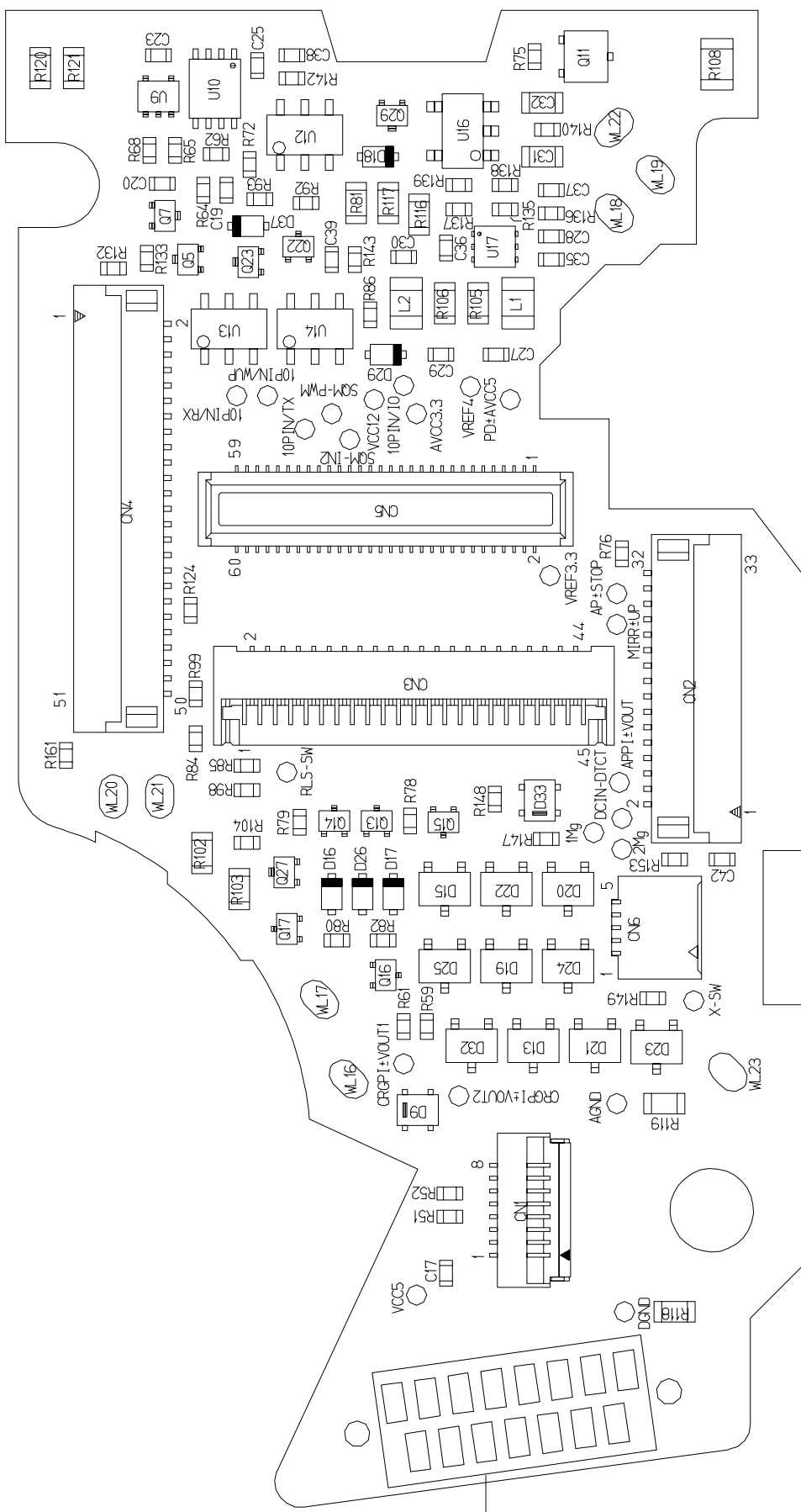

S-RESET	S-VDD3.3
S-Rx	S-Tx
OC00A	FLMD0
DEBUG	OC00B
	DGND
M-VCC3.3	M-MD
M-Tx	M-Rx
M-RESET	DGND

メイン基板

MAIN BASE PLATE

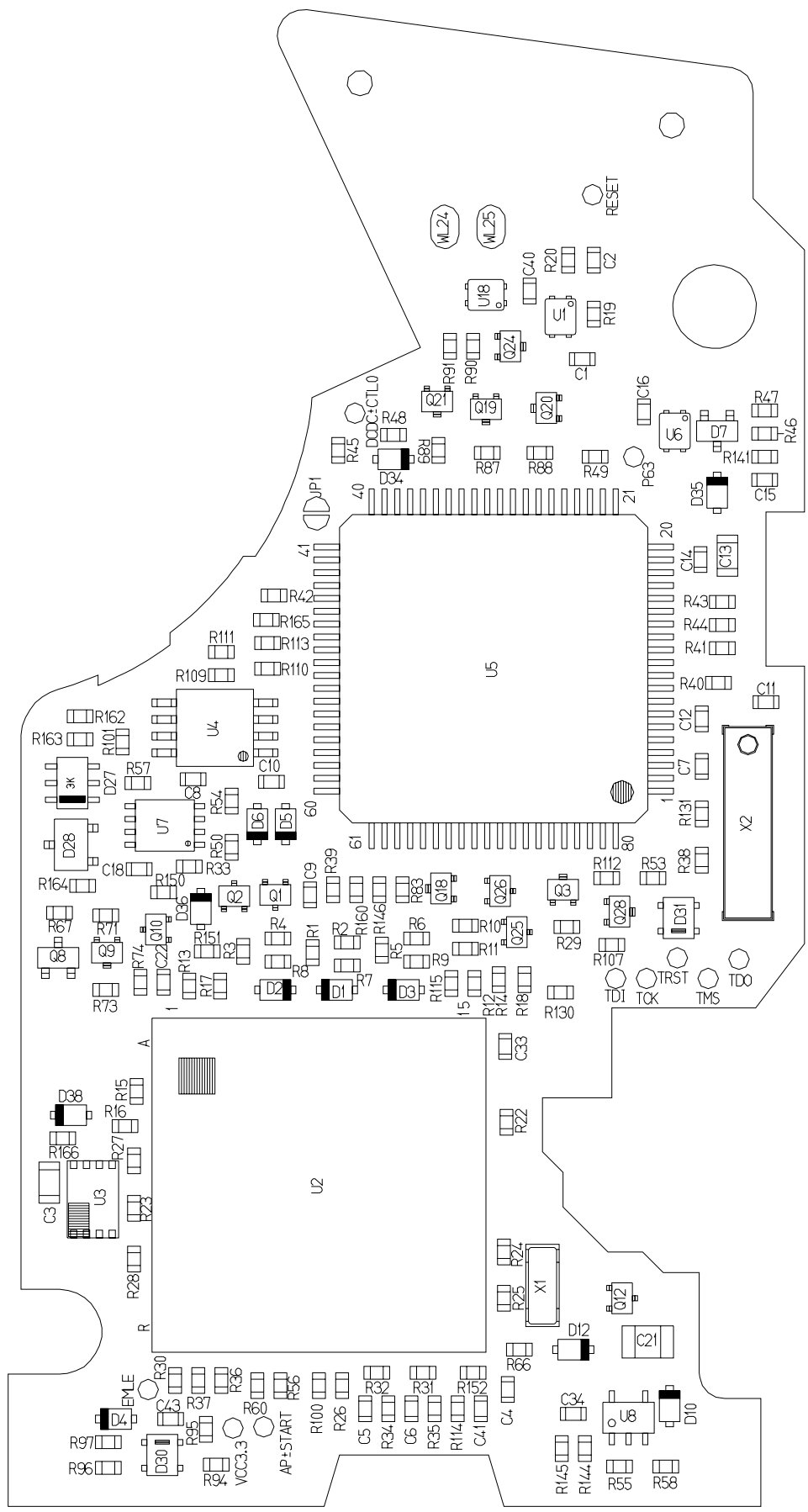

上カバー FPC
TOP COVER FPC

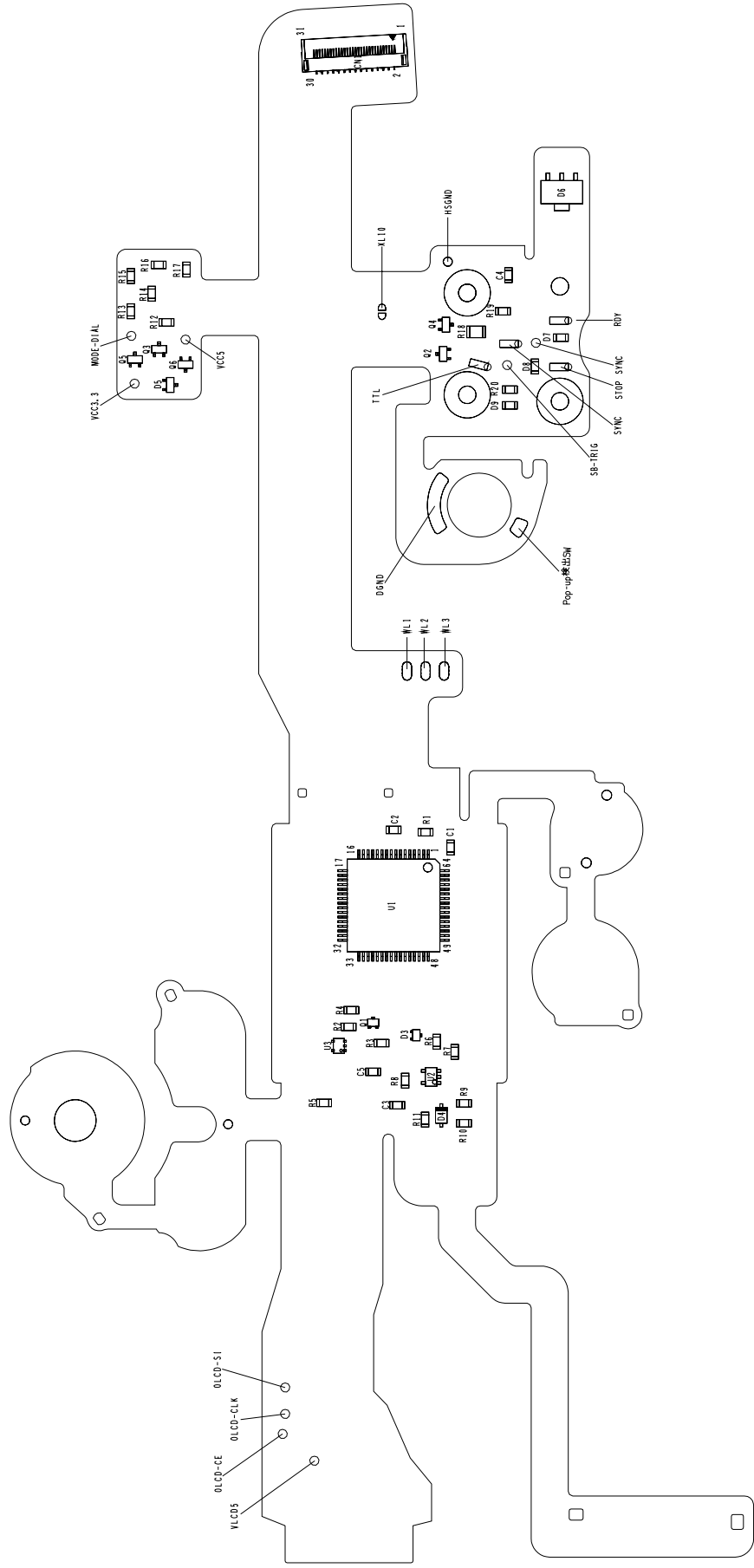

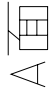

VBA22001-R. 3754. A

DG 基板
DG PCB

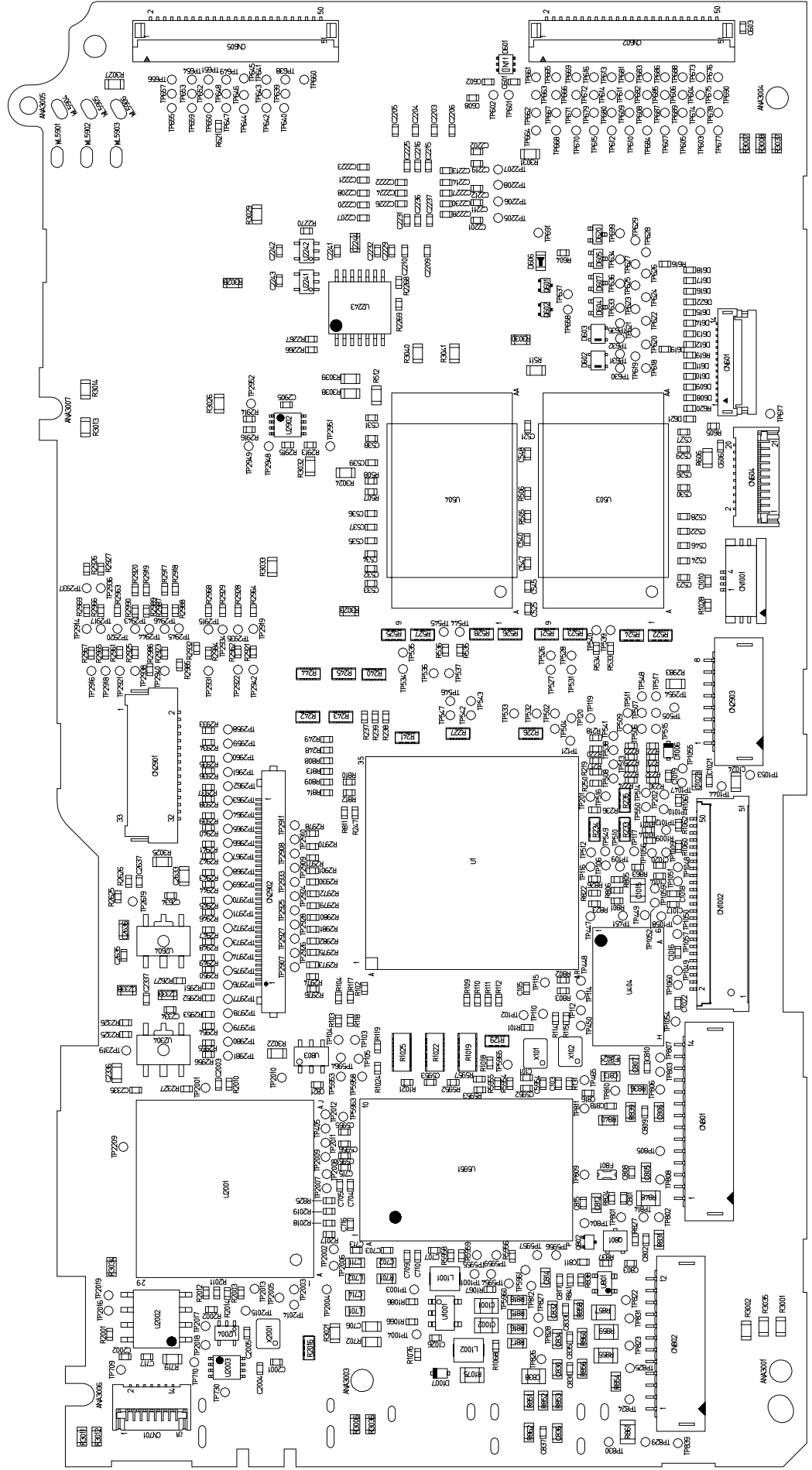

VBA22001-R. 3754. A

PD 基板 (表)

PD BASE PLATE (Surf face)

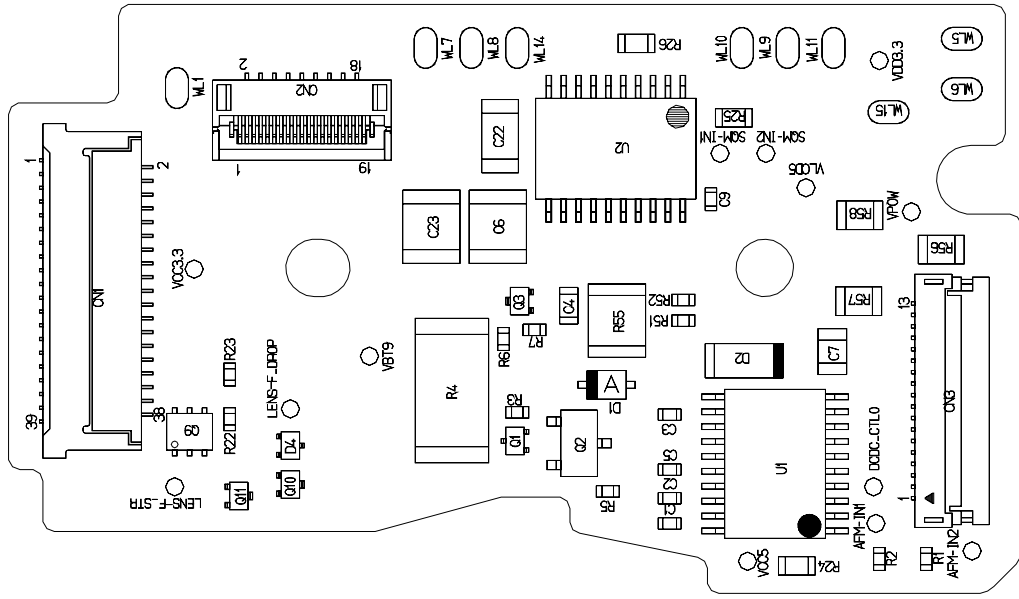

PD 基板 (裏)

PD BASE PLATE (Reverse face)

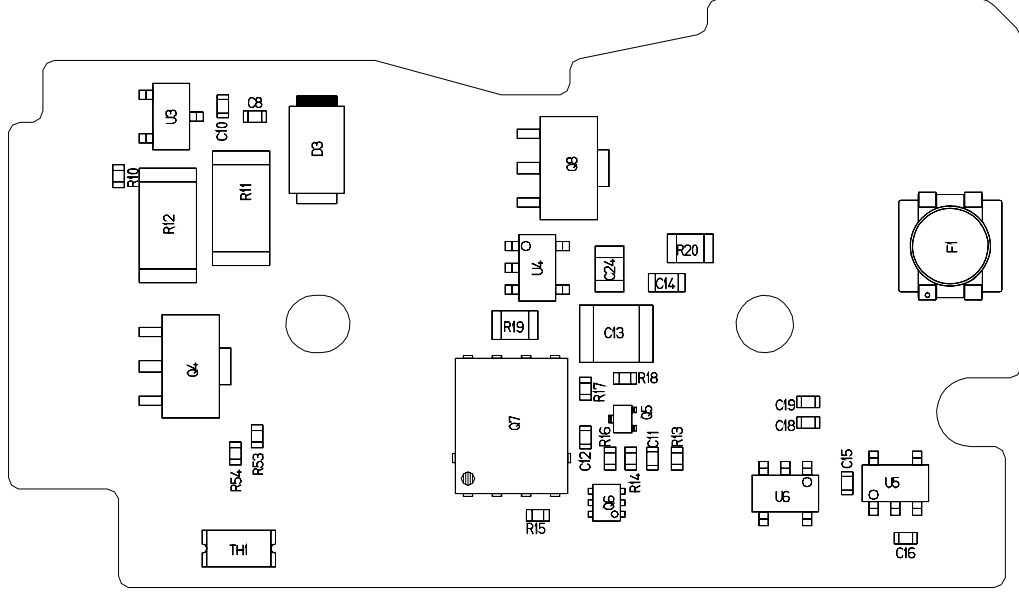

VBA22001-R. 3754. A

SB 基板 (裏)
SB BASE PLATE (Reverse face)

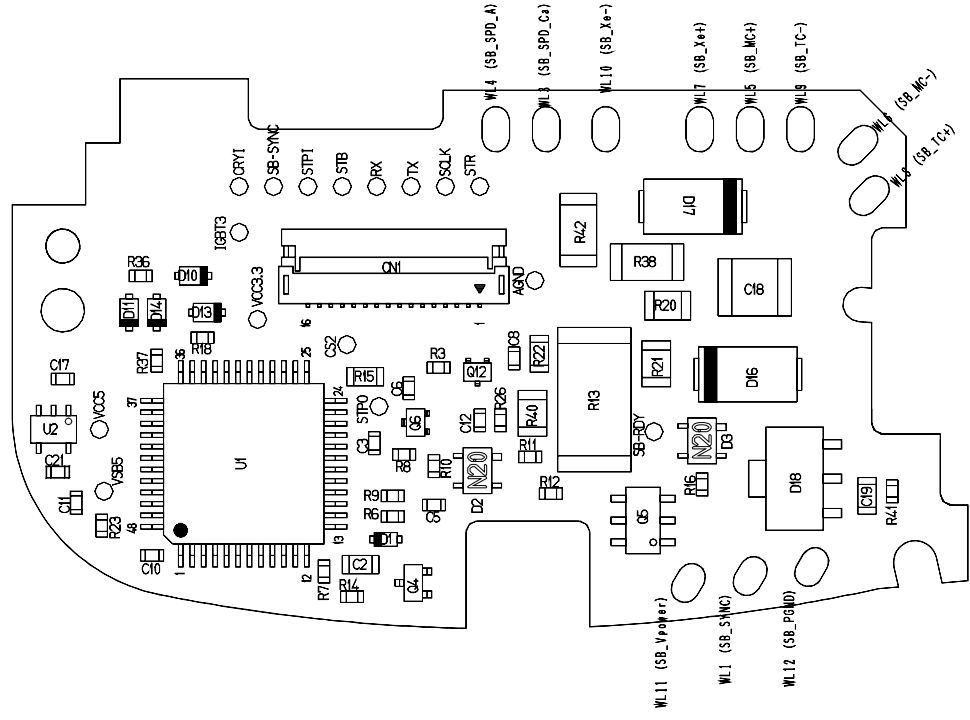

SB 基板 (表)
SB BASE PLATE (Surf face)

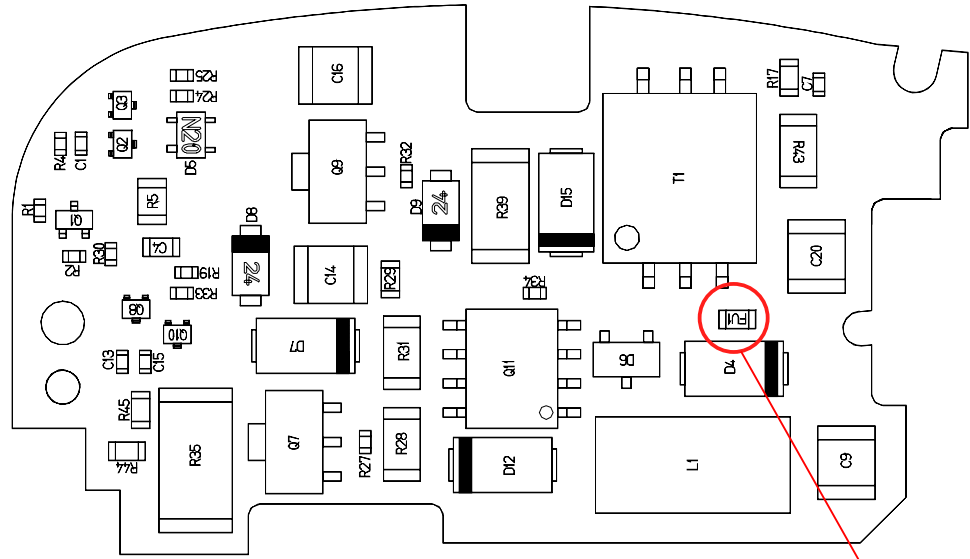

ヒューズ FUSE
1S460-012

DC/DC 基板

DC/DC BASE PLATE

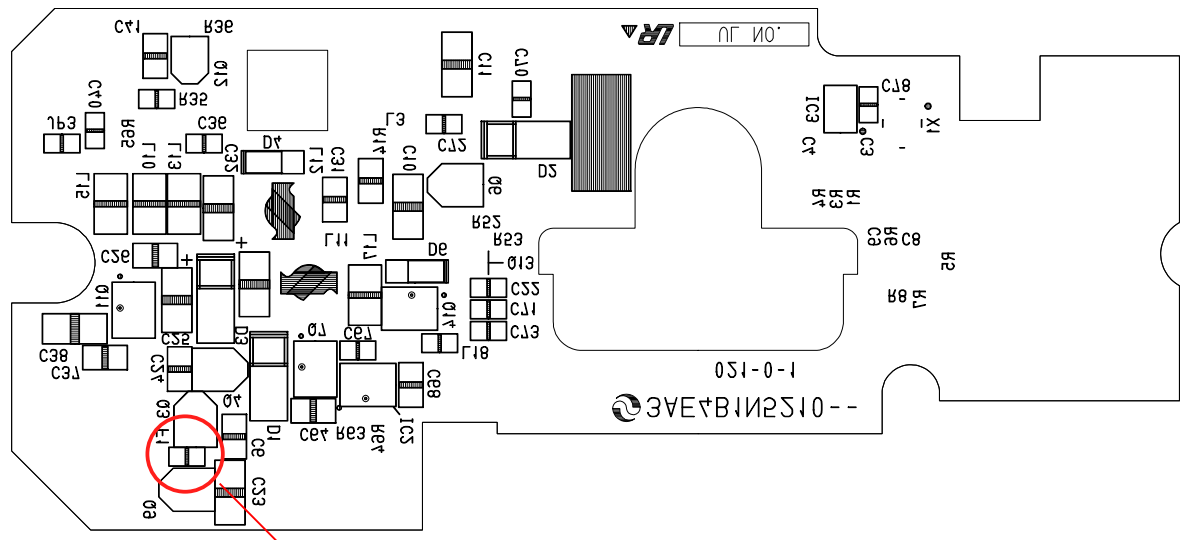

FUSE
1S999-165

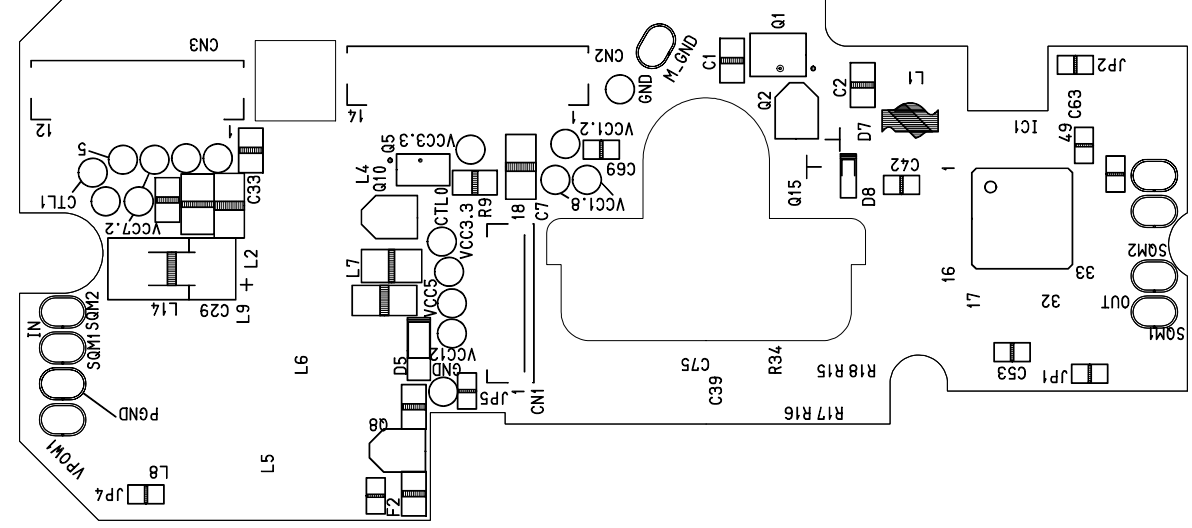

VBA22001-R. 3754. A

CF 基板
CF BASE PLATE

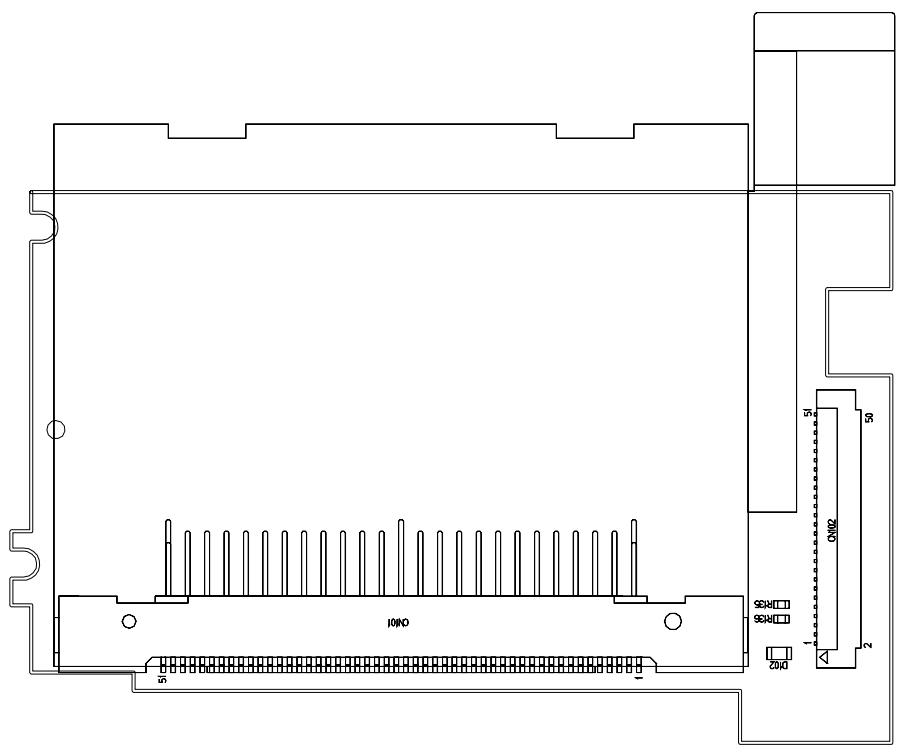

IF 基板 (表)

IF BASE PLATE (Surf face)

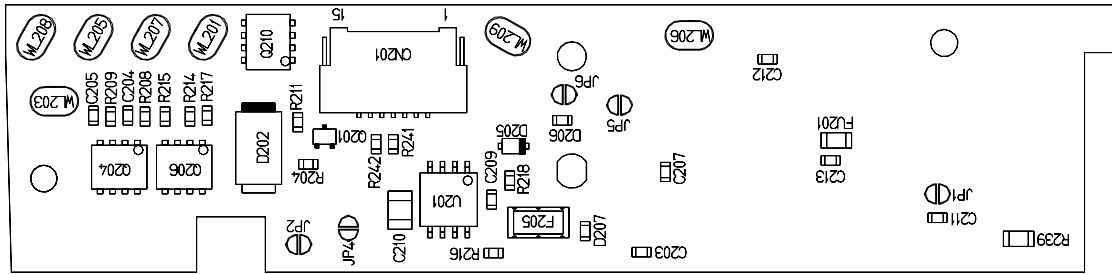

IF 基板 (裏)

IF BASE PLATE (Reverse face)

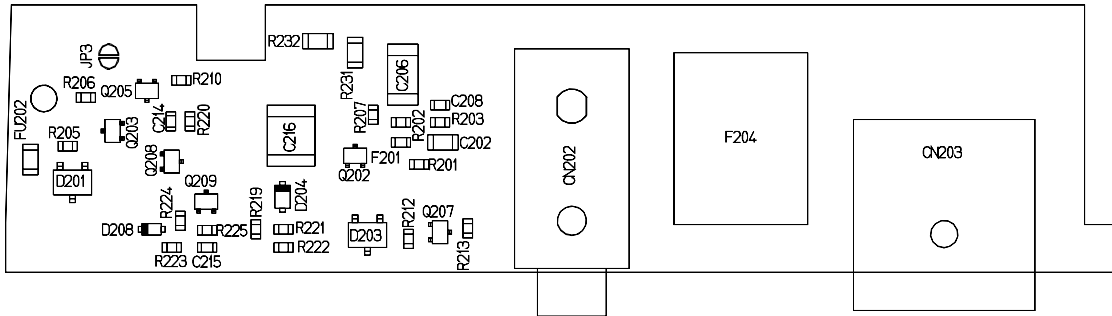

DC/DC SZ 基板
DC/DC SZ BASE PLATE

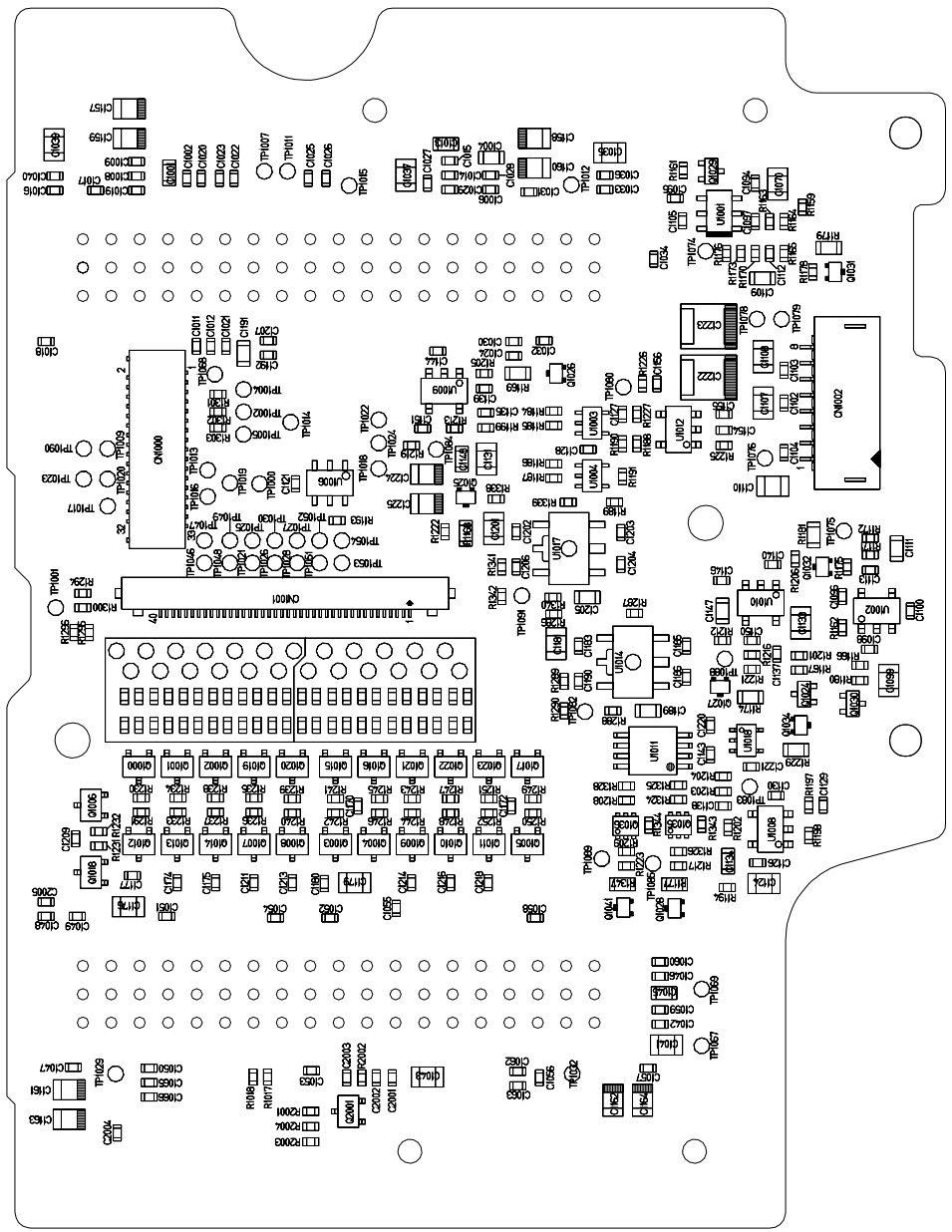

外 LCD FPC
OUTSIDE LCD FPC

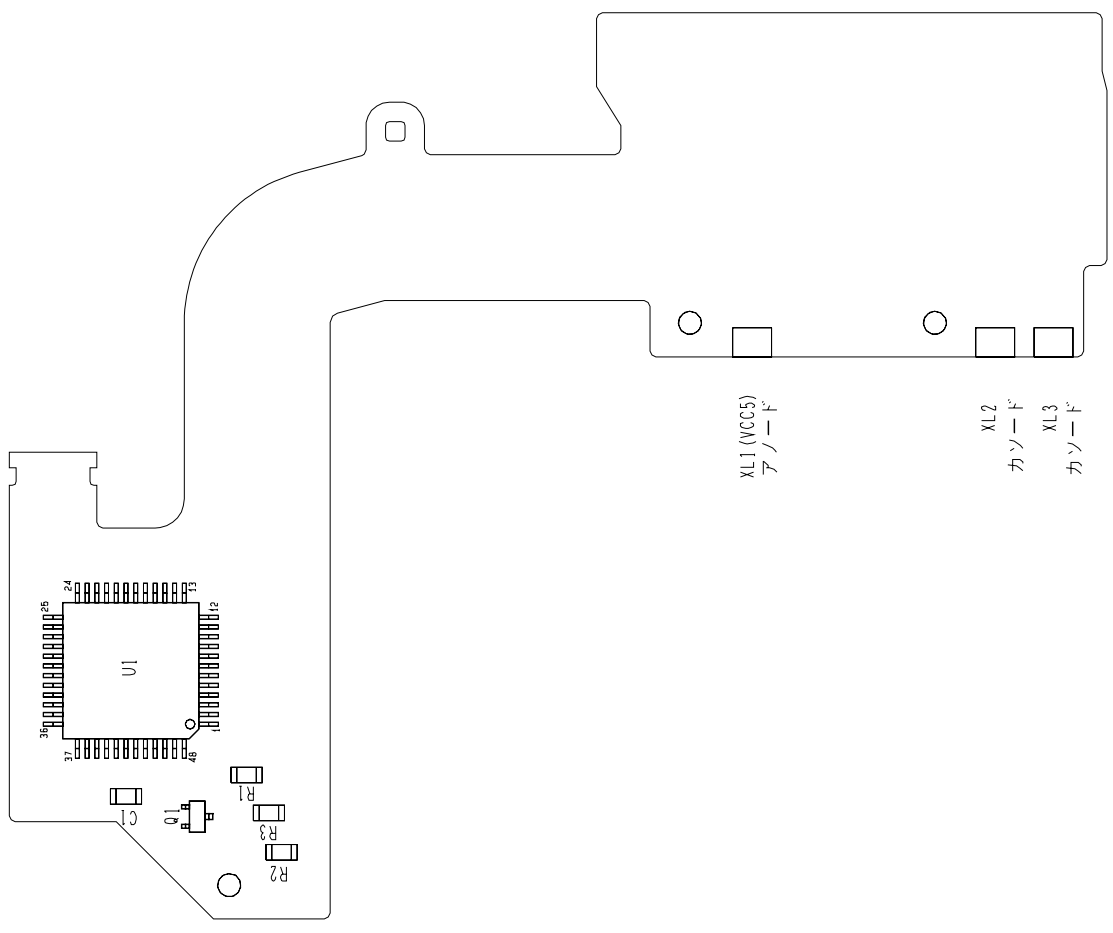

ヘッド FPC
PENTA FPC

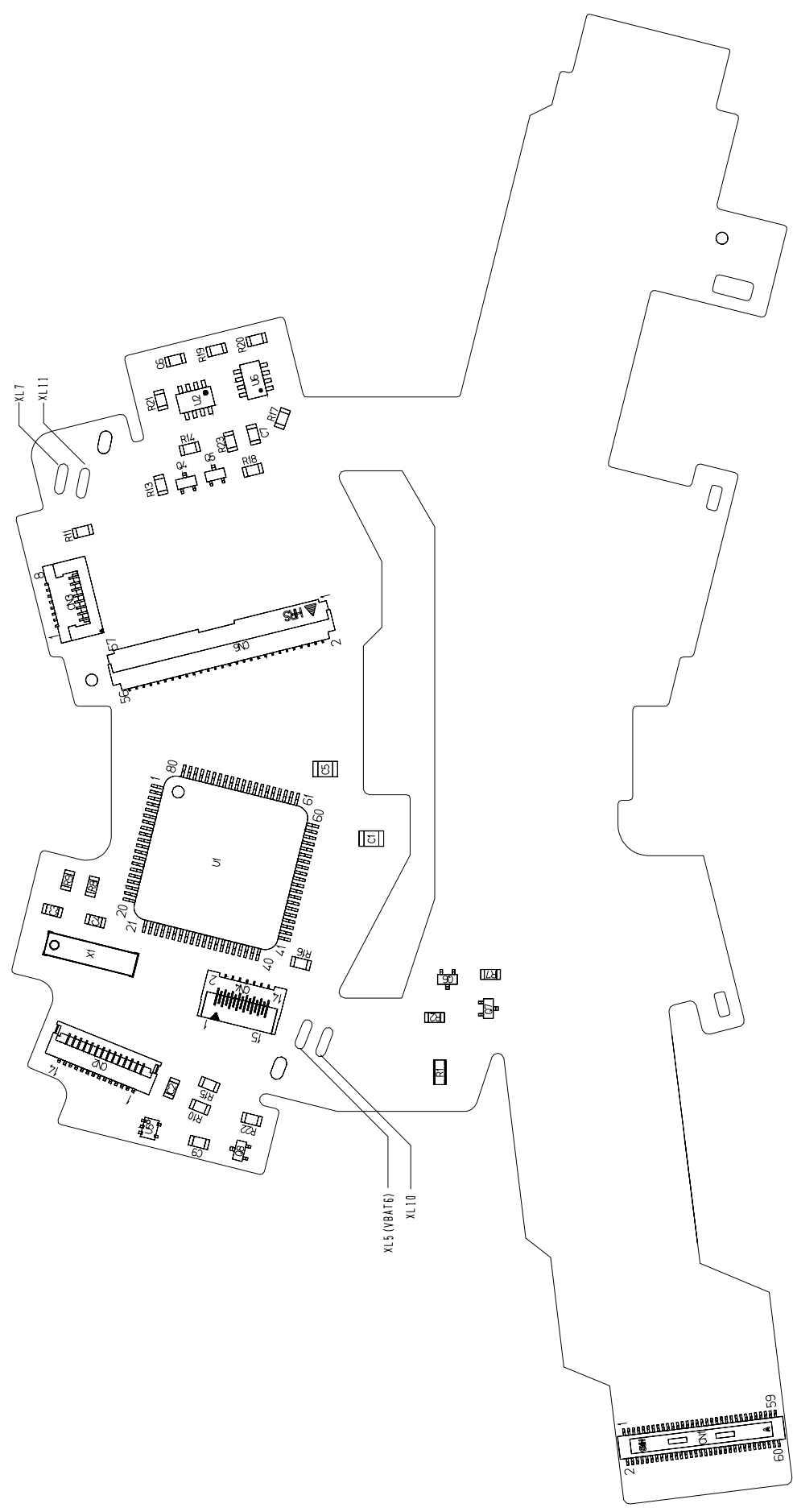

10 L > FPC
10PIN FPC

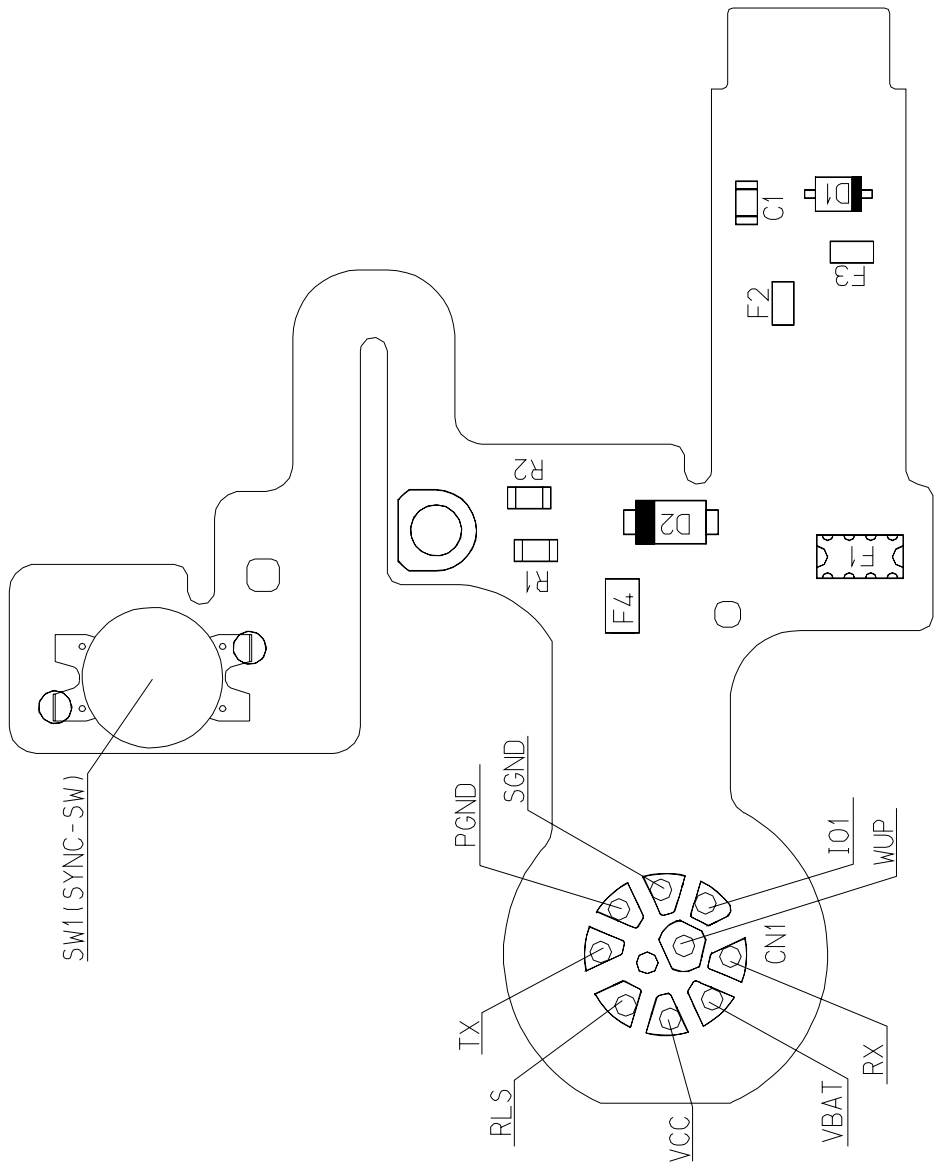

Inspection standards

Items	Judgment standard	Remarks
External view	Btwn top cover & apron: 0.2 mm or less	Visual check
Step (height difference)	Other parts: 0.3 mm or less Moving parts: 0.5 mm or less Rubber parts: up to 0.5mm	Digital micrometer
Gap	Btwn Top cover & Apron: 0.2 mm or less Btwn Top display panel window (surrounding) & Top cover: 0.45 mm or less Sub-command dial gap (lower part): 0.3mm ± 0.3 mm or less SB case & Top cover; SB case & Apron (when built-in speedlight is stored) : 0.5 mm or less Btwn Diopter adjusting knob (upper part) & Top cover : 1.5 mm or less Btwn Metering mode selector dial (upper part) & Top cover : 0.6 mm or less Other parts: 0.3 mm or less Moving parts: 0.5 mm or less	Visual check Thickness gauge
Size / Force	Protrusion: 0.9 ± 0.2 mm	Digital micrometer
Shutter release button	Halfway pressing force: 85 ± 15 g Halfway pressing stroke: 0.35 ± 0.1 mm Releasing force: 320 ± 50 g Releasing stroke: 0.3 ± 0.1 mm (Half-release pressing ON) Extra stroke after releasing button: 0.4 mm or more Difference btwn Half-releasing and Full pressing force: 235 ± 50 g	Tension gauge
Aperture lever	3.4 height: $3.4 +0.15/-0.10$ mm	3.4 height gauge
Main mirror	45° angle: Up-down $\pm 15'$ Right-left $\pm 25'$ Distortion: 6' or less Clearance for up-mirror in mirror box: None Play: 0.2 mm or less	Collimator Main mirror tool Visual check Feeling in hand
Sub-mirror	59° angle: Up-down $0' +5'/-30'$ Right-left $\pm 20'$ Distortion: 8' or less	Sub-mirror tool
∞ Infinity focus	From "-80" to "+40" μ m	

Items	Judgment standard	Remarks
AF accuracy		
Yaw	Center : ± 4 mrad Others: ± 10 mrad	PC Special tool Brightness box
Pitch	Center : ± 5 mrad Others: ± 11 mrad	
Block Def amount	Others than Side: 0 ± 50 μm Side: 0 ± 60 μm	
AF-assist illuminator		AF50/1.4D
Lighting level	Range from EV5.2 to 6.2	Brightness box
AE accuracy		
Exposure on image	1/8000, F2 (EV16) ※ : ± 0.6 EV 1/2000, F2.8 (EV14) ※ : ± 0.50 EV 1/250, F4 (EV12) ※ : ± 0.50 EV 1/60, F5.6 (EV11) ※ : ± 0.50 EV 1", F8 (EV6) ※ : ± 0.50 EV Dispersion: 0.3 EV Difference in AE mode: 0.4 EV Difference in Metering mode: 0.3 EV Data spread in min. aperture/continuous shooting: 0.5 EV	AF50/1.4D (∞) "A" light source brightness box < Judge under conditions of ISO200, Center weighted metering ($\phi 8$ mm), RAW data "G" (200*200 pixels) >
Shutter accuracy		
Speed accuracy	1/8000 : ± 0.55 EV From 1/2000 to 1/125 : ± 0.35 EV From 1/125 to 30 sec.: ± 0.2 EV	Shutter speed tester
Dispersion	1/8000 : 0.45 EV or less From "1/2000" to "1/125": 0.35 EV or less From "1/125" to "30" sec.: 0.25 EV or less	
Shutter curtain speed	Both front and rear curtains (up-down 21 mm or less): approx. 2.45 ms or less	
Shutter curtain bound	Black/white bound (within frame): None	
Synchronization	Timelag: (16.6mm-frame): From "- 0.1" to "0.4" ms	

Items	Judgment standard	Remarks
<p>Viewfinder</p> <p>Inner LCD lower panel window position</p> <p>Finder field frame</p> <p>Field of viewfinder (frame coverage)</p> <p>Parallax (Difference of center from the shot image/sensor)</p> <p>Eye point</p>	<p>Up-down position: No outstanding misalignment</p> <p>Tilt: 1 ° or less</p> <p>Lens vignetting/distortion: No outstanding vignetting/distortion</p> <p>Tilt: (based on Bottom cover): 90°± 30' or less</p> <p>Relative angle to image sensor: 30' or less</p> <p>In height and width: "95%" +0% / -2%</p> <p>Up-down: 0.5 mm or less</p> <p>Right-left: 0.5 mm or less</p> <p>"Minus"-end: 16±10%</p> <p>In case of "1m⁻¹": 18±10%</p> <p>"Plus"-end: 21±10%</p>	<p>Visual check</p> <p>AF50/1.4D, F5.6</p> <p>Looking through viewfinder, measure a tilt of indication line (parallel to the bottom) from the bottom line of the frame.</p> <p>AF50/1.4D, F5.6</p> <p>Mark a line indicating the field of viewfinder and take a picture. Then, measure a difference (tilt) between the marked indication line and actual shot.</p> <p>Vernier caliper</p> <p>Eye point tool</p>
Screen misalignment	Tilt: 30' or less	<p>E screen</p> <p>B screen</p> <p>Special chart</p>
Sequence release time lag	<p>AF-M: 47 ms or less</p> <p>AF-C: 47 ms or less</p> <p>Release with a one push: 210 ms or less</p> <p>Release when vibration reduction lens attached: : 60 ms or less</p> <p>Pre-flash release: 100 ms or less</p>	<p>Oscilloscope</p> <p>Constant-voltage power source</p> <p>Power tool</p> <p>EV9</p> <p>VR70-200ED/F2.8G</p> <p>AF-M, AE-A, AMP</p> <p>SB-800 (Multi-sensor balanced fill-flash)</p> <p>Measure the time taken from releasing the shutter to switching ON for X-signal.</p>

Items	Judgment standard	Remarks
Standby (idle) / consumed current	Main SW / OFF: 250 μ A or less (Do NOT press any operational buttons.) Main SW / ON (Half-release timer: OFF): 250 μ A or less Main SW / ON (Half-release timer: ON): 250 m A or less Main SW / ON (Illumination: ON): 280 mA or less Main SW / ON (TFT ON): 350 mA or less During live view: 1600 mA or less	Constant-voltage power source Battery tool Ammeter AF50/1.4 EV12
Operation time / consumption current accumulated	Lens scan AF50/1.8 Operation time: 1000 ms or less Consumption current accumulated: 500 mAsec or less AF70-210/4-5.6 Operation time: 2000 ms or less Consumption current accumulated: 800 mAsec or less Preview Operation time: 150ms or less Consumption current accumulated: 100 mAsec or less Release without memory card Operation time: 180 ms or less Consumption current accumulated: 350 mAsec	Constant voltage Battery tool Special tool Oscilloscope LV12
Rush current	Shooting operation: 4.0A or less	Constant voltage power source Battery tool Special tool Oscilloscope LV12
Clock accuracy	Difference par month: \pm 30 seconds (20°C)	Wave clock
BC level	Level 5 5 lights up Charge remaining: 81-100% Level 4 4 lights up Charge remaining: 61-80% Level 3 3 lights up Charge remaining: 41-60% Level 2 2 lights up Charge remaining: 21-40% Level 1 1 light up Charge remaining: 1-20% Level 0 1 light blinking Charge remaining: 0%	Check the level in the LCD control panel on top of camera or TFT battery information Communication- capable battery tool
Bulb battery life	When special Li-ion is used: 90 minutes or more	Clock Remote wire





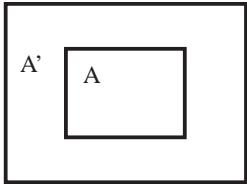



Items	Judgment standard	Remarks
Battery life EN-EL3e	Professional mode Room temperature: 2550 frames or more 0°C 2350 frames or more CIPA mode 23 ± 2°C 1050 frames or more	Card used: Sundisk Extreme III 2GB Battery used:EN-EL3e
Image-related Appropriate level	<u>Judgment method</u> When RAW recorded: Within the area of 425 pixels x 425 pixels at the center of screen, calculate the average of G-14 bit data. When TIFF/JPEG recorded: Within the area of 425 pixels x 425 pixels at the center of screen, calculate the average of Y-8 bit data <u>Standard</u> RAW (14bit) Lo 1 3428±200 (±0.1EV) Lo 0.7 2717±160 (±0.1EV) Lo 0.5 2421±145 (±0.1EV) Lo 0.3 2158±130 (±0.1EV) ISO 200-ISO6400 1714±100 (±0.1EV) [TIFF,JPEG] • Standard Lo 1, Lo 0.7, Lo 0.5, Lo 0.3, ISO200-6400 134-144 • Neutral Lo 1, Lo 0.7, Lo 0.5, Lo 0.3, ISO200-6400 131-140 • Vivid Lo 1, Lo 0.7, Lo 0.5, Lo 0.3, ISO200-6400 132-144	AF50mm/F1.4D(CPU built-in metering reference lens) F5.6 Lo 1 1/15 LV10+ND2 Lo 0.7 1/20 LV10+ND2 Lo 0.3 1/25 LV10+ND2 ISO200 1/30 LV10+ND2 ISO250 1/20 LV10+ND4 ISO320 1/25 LV10+ND4 ISO400 1/30 LV10+ND4 ISO500 1/20 LV10+ND8 ISO640 1/25 LV10+ND8 ISO800 1/30 LV10+ND8 ISO1000 1/20 LV10+ND16 ISO1250 1/25 LV10+ND16 ISO1600 1/30 LV10+ND16 ISO2000 1/20 LV10+ND32 ISO2500 1/25 LV10+ND32 ISO3200 1/30 LV10+ND32 ISO4000 1/20 LV10+ND64 ISO5000 1/25 LV10+ND64 ISO6400 1/30 LV10+ND64 AE: M mode Distance from object: Closely contact Focal length: Infinity Image size:L, M, S WB: Preset (for every sensitivity)

Items	Judgment standard	Remarks
Resolution	<p><u>Judgment method</u></p> <p>When TIFF/JPEG recorded: Take a shot by matching the angle of view of the chart's vertical direction. Adjust the speed so that brightness becomes 220 ± 5LSB (8bit) at white part about the center of chart.</p> <p><u>Standard</u></p> <p>When TIFF recorded: Horizontal resolution 1900 TV lines or more Vertical resolution</p> <p>When JPEG recorded: Horizontal resolution 1800 TV lines or more Vertical resolution</p>	<p>AFS80-200mm/F2.8D 105mm F5.6 AE: M mode Image size: L ISO200</p>
Pixel defects: White pixel against dark background	<p><u>Judgment method</u></p> <p>Judge the level of white pixels</p> <p><u>Standard</u></p> <p>When Raw recorded: At 25°C : 240 LSB or less At 40°C : 960 LSB or less</p> <p>When TIFF/JPEG recorded: At 25°C : 30 LSB or less At 40°C : 60 LSB or less</p>	<p>Lens: Any (lens cap) Shutter speed: 1/30 AE: M mode Image size: L WB: Direct sunlight Temperature: $25 \pm 2^{\circ}\text{C}$, $40^{+5}_{-0^{\circ}}\text{C}$ ISO200</p>
Dusts in shot image	<p><u>Judgment method</u></p> <p>Compensate exposure so that the center of "425×425 pixel" image becomes 156-187 LSB), compared to correct exposure. In zone II area in JPEG of "G shading"item, judge based on dust contrast, size, quantity, and distance btwn dusts.</p> <p><u>Standard</u></p> <ul style="list-style-type: none"> • Point defect Allowable quantity: 10 dusts or less in total (when contrast 9% or less, and size is $\phi 18$Pixel or less) • Pixel defect Allowable contrast (15% or less); size ($\phi 6$Pixel or less) 	<p>AF105mm/F2.8D F16 AE: M mode Image quality: JPEG FINE WB: Preset ISO200</p>
Color reproducibility	<p><u>Judgment method</u></p> <p>Shoot by exposure so that the batch 22 of Macbeth chart becomes $L = 58 \pm 3$.</p> <p><u>Standard</u></p> <p>For every color Difference from target value: $\Delta C = 3$ or less</p>	<p>AF-MC105mm/2.8D Object of shooting: Macbeth Color Checker (Background: black) Light source: Artificial sunshine AE: M (F5.6) Color mode: Mode I Image quality: JPEG Image size: L ISO Lo1.0, Lo0.7, lo0.3, 200,400,800,1600,3200, 6400,Hi1,Hi2</p>



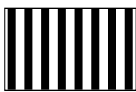









Items	Judgment standard	Remarks
<p>TFT unit</p> <p>Point defect</p>	<p>Luminescent pixels: 3 or less (G = 0, Others than "G" \leq 1 in "A" section)</p> <p>There must not be 2 consecutive defective pixels.</p> <p>Black pixels: 3 or less (1 or less in "A" section)</p> <p>There must not be 2 consecutive defective pixels.</p> <p>Total of luminescent pixels and black pixels: 3 or less (1 or less in "A" area)</p> <p>A : 19.08×25.44mm</p> <p>A' : 38.16×50.88mm (excluding "A")</p> <p>(The size in height and width is measured by aligning the center of the monitor.)</p>	
<p>Backlight life</p>	<p>5000 hours or more (at less than 40°C)</p>	

工具・TOOLS

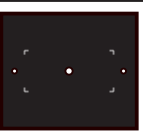
★：新規設定工具・NEW TOOL

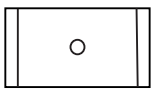
工具番号 Tool No.	名称 Name of tool	備考 Others
CFD409Z  1kg	サンコール CFD409Z SANKOL CFD409Z	
C-8008B 	セメダイン 8008 (黒) CEMEDAIN 8008 (BLACK)	
G92KA 	フロイル G-92KA 20G FLOIL G-92KA 20G	
OS-30MEL  200g	ドライサーフ OS-30MEL DRY SURF OS-30MEL	OS-30MF 使用可 OS-30MF IS AVAILABLE
EDB0011 	ネジロック (赤) 1401C SCREW LOCK 1401C	
J15259 	A F 調整工具台 AF ADJUSTING TOOL	
J15280 	Z レンズ用支持ホルダー LENS HOLDER	
J15264 	高周波タイプ蛍光灯器具 ILLUMINATION BOX FOR AF ADJUSTMENT	
J15407 	マルチカム2000 AFチャート MULTI CAM 2000 AF CHART	FOR D2SERIESE
J15409 	チャートボード CHART BOARD	FOR D2SERIES, D40
J18001-1 	ボディバック出し工具 BODY BACK FOCUS GAUGE	
J18004 	絞りレバー高さ点検工具 APERTURE LEVER POSITIONING GAUGE	
J18010 	無限大合致基準レンズ50/1.8 INFINITY STANDARD LENS 50/1.8	払底品 OUT OF STOCK

工具番号 Tool No.	名称 Name of tool	備考 Others
J18191 	NDフィルター 8 × ND FILTER 8X	2 枚使用 IT USES BY TWO PIECES.
J18230 	YAW・PITCH工具 YAW・PITCH ADJUSTMENT TOOL	FOR F5, F100, F90, F90X, D-SLR
J18266 	A F 調整用 Z レンズ (1 m 用) Z ADJUSTMENT LENS (FOR 1m)	FOR F5, F100, D-SLR
J18267 	A F 5 0 / 1 . 4 D LENS AF50/1.4D	
J18358 	NDフィルター 4 × ND FILTER 4X	2 枚使用 IT USES BY TWO PIECES.
★ J65119 	カメラ部調整用ソフト ADJ. SOFT FOR CAMERA	
J19001 	∞合致コリメーター F = 6 0 0 mm COLLIMATOR F=600mm	
J19004-1 	インジケータ及びスタンド DIAL INDICATOR AND STAND	
J19123 	シャッター試験機 EF-1 (CE) SHUTTER TESTER EF-1 (CE)	共立電機製 KYORITSU ELECTRIC EF-8000 USABLE
J19132 	メイン・サブミラー角度検査機 MAIN/SUB MIRROR ANGLE INSPECTION TOOL	FOR D300, ETC
J61185 	撮像関係調整用レンズ D1 STANDARD LENS	FOR D-SLR
J61222 	二次元バーコードリーダー TWO-DIMENSIONAL BARCODE READER	FOR S10 ETC
J61223 	ライティングルーペ LIGHTING LOUPE	FOR D-SLR

工具番号 Tool No.	名称 Name of tool	備考 Others
J61229 	D 3 工具ボディ (撮像用基準ボディ) D3 TOOL BODY	D3 TOOL BODY
★ J65120 	撮像調整用ソフト ADJ. SOFT WARE FOR IMAGING	
J63068 	輝度計 (BM-3000) LUMINANCE METER BM-3000	
J63070 	カラービューア COLOR VIEWER	
J63085 	フィルター SP 1 FILTER SP1	FOR D2H, D70, D70s, D50, D200, D80, D40
J63087 	フィルター SP 3 FILTER SP3	FOR D2H, D70, D70s, D50, D200, D80, D40
J63097 	D 3 用 A E C C D 用 チャートボード AE/CCD USE CHART BOARD FOR D3	
J63098 	D 3 用 A F X-Y チャート AF X-Y CHART FOR D3	
★ J15432 	D700 用合致スクリーン FOCUS SCREEN FOR D700	
★ J15433 	D700 45度メインミラー工具 △ (Revision) 45 DEG ANGLE MAIN-MIRROR TOOL FOR D3 D3 D700	
J65096 	QRリーダーソフト QR READER SOFTWARE	FOR S10 ETC
L-241 	ロックタイト #241 (青) LOCTITE #241	
J61230 	D 3 用 A E 受光部アダプター D3 LIGHT RECEIVE ADAPTER	



工具番号 Tool No.	名称 Name of tool	備考 Others
MZ-800SEL 	ドライサーフ MZ-800SEL DRY SURF MZ-800SEL	
	アロンアルファ QUICK DRYING GLUE	汎用品 RJ IS NOT AVAILABLE
	ACアダプター EH-5 AC ADAPTER EH-5	製品転用 RJ IS NOT AVAILABLE
	USBケーブル UC-E4 USB CABLE UC-E4	製品転用 RJ IS NOT AVAILABLE
	パーソナルコンピュータ PERSONAL COMPUTER	汎用品 RJ IS NOT AVAILABLE
	ヘクスキー (φ1.5mm) HEX. KEY WRENCH (φ1.5mm)	汎用品 RJ IS NOT AVAILABLE
	AF28/2.8D LENS AF28/2.8D	製品転用 RJ IS NOT AVAILABLE
	AF70-300/4-5.6D OR AF-SVR70-300/4.5-5.6 LENS AF70-300/4-5.6D OR LENS AF-SVR70-300/4.5-5.6	製品転用 RJ IS NOT AVAILABLE
J19109 	MC-31 (接続コード) MC-31 (CONNECTING CORD)	FOR D3, ETC
	市販のストレートケーブル MARKETED STRAIGHT CABLE	汎用品 RJ IS NOT AVAILABLE
	フラッシュメーター FLASH METER	汎用品 RJ IS NOT AVAILABLE
	安定化電源 (10V 5A) POWER SUPPLY (10V 5A)	汎用品 RJ IS NOT AVAILABLE
	MB-D10 BATTERY PACK MB-D10	製品転用 RJ IS NOT AVAILABE

工具番号 Tool No.	名称 Name of tool	備考 Others
J18360 	基準反射布 Standard reflector 1.5M × 1.5M	FOR C-DSC (L15, L11 etc)
J18393 	斜めチャート SLANT CHART	
J19124 	Zライト Z-light	