

Nikon

DIGITAL CAMERA

D3X

User's Manual

En

Where to Find It

Find what you're looking for from:



The Q&A Index



pp. iv–ix

Know what you want to do but don't know the function name? Find it from the "question and answer" index.



The Table of Contents



pp. x–xvii

Find items by function or menu name.



The Quick Start Guide



pp. 23–24

A brief guide for those who want to get started taking pictures right away.



The Index



pp. 442–448

Search by key word.



Error Messages



pp. 414–420

If a warning is displayed in the viewfinder or monitor, find the solution here.



Troubleshooting



pp. 407–413

Camera behaving unexpectedly? Find the solution here.



For Your Safety

Before using the camera for the first time, read the safety instructions in "For Your Safety" (pg. xviii).

Digitutor

Digitutor, a series of "watch and learn" manuals in movie form, is available from the following website:

http://www.nikondigitutor.com/index_eng.html

Package Contents

Be sure all items listed here were included with your camera.

Memory cards are sold separately.

- ❑ D3X digital camera (pg. 3)
 - ❑ BF-1A body cap (pp. 4, 391)
 - ❑ BS-2 accessory shoe cover (pg. 3)
 - ❑ EN-EL4a rechargeable Li-ion battery with terminal cover (pp. 32, 34)
 - ❑ MH-22 quick charger with power cable and two contact protectors (pp. 32, 437)
 - ❑ UC-E4 USB cable (pp. 256, 264)
 - ❑ USB cable clip (pg. 259)
 - ❑ EG-D2 audio/video cable (pg. 274)
 - ❑ AN-D3X strap (pg. 5)
-

- ❑ Warranty
- ❑ *User's Manual* (this guide)
- ❑ *Quick Guide*
- ❑ *Software Installation Guide*
- ❑ Software Suite CD-ROM
- ❑ Registration card (U. S. A. only)

Symbols and Conventions

To make it easier to find the information you need, the following symbols and conventions are used:



This icon marks cautions; information that should be read before use to prevent damage to the camera.



This icon marks notes; information that should be read before using the camera.

















Menu items, options, and messages displayed in the camera monitor are shown in brackets ([]).



Trademark Information

Macintosh, Mac OS, and QuickTime are registered trademarks of Apple Inc. Microsoft, Windows and Windows Vista are either registered trademarks or trademarks of Microsoft Corporation in the United States and/or other countries. CompactFlash is a trademark of SanDisk Corporation. Microdrive is a trademark of Hitachi Global Storage Technologies in the United States and other countries. HDMI, the HDMI logo, and High-Definition Multimedia Interface are trademarks or registered trademarks of HDMI Licensing LLC. PictBridge is a trademark. All other trade names mentioned in this manual or the other documentation provided with your Nikon product are trademarks or registered trademarks of their respective holders.

D3X

-  **Introduction**
-  **Tutorial**
-  **Image Recording Options**
-  **Focus**
-  **Release Mode**
-  **ISO Sensitivity**
-  **Exposure**
-  **White Balance**
-  **Image Enhancement**
-  **Flash Photography**
-  **Other Shooting Options**
-  **More About Playback**
-  **Voice Memos**
-  **Connections**
-  **Menu Guide**
-  **Technical Notes**

Q&A Index

Find what you're looking for using this "question and answer" index.

■ ■ *New Features*

Question	Key phrase	See page
How do I take pictures in 35mm format?	Image area	60
How do I take high-quality NEF (RAW) photos?	14-bit NEF (RAW)	69
How do I record photographs using two memory cards?	Slot 2	72
Can I use the monitor as a viewfinder?	Live view	90
Can I control how photos are processed?	Picture Controls	162
How do I preserve details in shadows and highlights?	Active D-Lighting	181
How do I focus on erratically moving subjects?	3D-tracking	308
Can I adjust focus separately for different lenses?	AF fine tune	361

■ ■ *Camera Setup*

Question	Key phrase	See page
How do I focus the viewfinder?	Viewfinder focus	47
How do I keep the monitor from turning off?	Monitor off delay	319
How do I keep the shutter speed and aperture displays from turning off?	Auto meter off	50, 318

Question	Key phrase	See page
How do I set the clock?	World time	40, 349
How do I set the clock for daylight savings time?		
How do I change time zones when I travel?		
How do I adjust monitor brightness for menus or playback?	LCD brightness	347
How do I restore default settings?	Two-button reset	204
How do I restore shooting menu defaults?	Reset shooting menu	293
How do I restore Custom Setting defaults?	Reset custom settings	304
How do I change the self-timer delay?	Self-timer delay	319
Can I reverse the electronic analog exposure display?	Reverse indicators	345
Can I display the menus in a different language?	Language	349
Can I save menu settings for use on a different D3X camera?	Save/load settings	358

■■ *Menus and Displays*

Question	Key phrase	See page
How do I get more information on a menu?	Help	31
How do I use the menus?	Using the menus	26
What do these indicators mean?	Viewfinder, control panels, shooting information display	8, 10, 12, 14
What information is in the shooting information display?		
What does this warning mean?	Error messages and displays	414
How much charge does the battery have left?	Battery level	48
How do I get more information about the battery?	Battery info	355

Question	Key phrase	See page
How do I keep the file number from being reset when I insert a new memory card?	File number sequence	322
How do I reset file numbering to 1?		
How do I clean the camera or lens?	Cleaning the camera	395

■ ■ Taking Photographs

Question	Key phrase	See page
How many more shots can I take with this card?	Number of exposures remaining	49
How do I take bigger photographs?	Image quality and size	66, 70
How can I get more photos on the memory card?		
Can I control how the camera focuses?	Autofocus	73
How do I take a lot of photographs quickly?	Release mode	86
Can I change the frame advance rate?	Shooting speed	88, 321
Can I shoot a self-portrait?	Self-timer mode	100
Can I take pictures under low light without the flash?	ISO sensitivity	104
Can the ISO sensitivity I choose be adjusted to ensure optimal exposure?	ISO sensitivity auto control	106
How do I freeze or blur moving objects?	Exposure mode S (shutter-priority auto)	116
How do I blur background details or keep both foreground and background in focus?	Exposure mode A (aperture-priority auto)	118

Question	Key phrase	See page
Can I set both shutter speed and aperture manually?	Exposure mode M (manual)	120
Can I make photos brighter or darker?	Exposure compensation	128
How do I make a time exposure?	Long time-exposures	122
Can I vary exposure or flash level automatically over a series of photos?	Exposure and flash bracketing	131, 328
Can I create multiple copies of a photo using different white balance settings?	White balance bracketing	135, 328
How do I adjust white balance?	White balance	140
How do I change settings for the optional flash unit?	Flash mode	194
How can I record multiple shots as a single photograph?	Multiple exposure	206
Can I record voice memo when taking a photograph?	Voice memo	248
Can I pick the standard exposure level?	Fine tune optimal exposure	316
How can I reduce blur?	Exposure delay mode	325

■ ■ *Viewing Photographs*

Question	Key phrase	See page
Can I view my photographs on the camera?	Camera playback	226
Can I view more information about photos?	Photo info	229
Why do parts of my photos blink?	Photo info, highlights	231, 282

Question	Key phrase	See page
How do I get rid of an unwanted photo?	Deleting individual photos	245
Can I delete several photos at once?	Delete	281
Can I zoom in on pictures to make sure they're in focus?	Playback zoom	243
Can I protect photos from accidental deletion?	Protect	244
Can I hide selected photos?	Hide image	281
How do I tell if parts of my photos may be overexposed?	Display mode: highlights	282
How do I tell where the camera focused?	Display mode: focus point	282
Can I view photos as they are taken?	Image review	287
Can I record a voice memo on photos?	Voice memo	251
Is there an automatic playback ("slide show") option?	Slide show	288

■ ■ Retouching Photographs

Question	Key phrase	See page
How do I bring out details in shadows?	D-Lighting	366
Can I get rid of red eye?	Red-eye correction	367
Can I crop photographs on the camera?	Trim	368
Can I create a monochrome copy of a photograph?	Monochrome	369
Can I create a copy with different colors?	Filter effects	370
Can I use camera to create JPEG copies of NEF (RAW) photographs?	Color balance	370
Can I overlay two photos to make a single image?	Image overlay	371

■■ Viewing or Printing Photographs on Other Devices

Question	Key phrase	See page
Can I view my photos on TV?	Television playback	274
Can I view my photos in High Definition?	HDMI	276
How do I copy photos to my computer?	Connecting to a computer	256
How do I print photographs?	Printing photographs	262
Can I print photos without a computer?	Printing via USB	263
Can I print the date on my photographs?	Time stamp	266, 270
How do I order professional prints?	Print set (DPOF)	272

■■ Optional Accessories

Question	Key phrase	See page
What optional flash units (Speedlights) can I use?	Optional flash units	187
What lenses can I use?	Compatible lenses	382
What AC adapters, remote cords, and viewfinder accessories are available for my camera?	Other accessories	387
What memory cards can I use?	Approved memory cards	394
What software is available for my camera?	Other accessories	391

Table of Contents

Q&A Index	iv
For Your Safety	xviii
Notices.....	xxi

Introduction **1**

Overview.....	2
Getting to Know the Camera.....	3
Camera Body	3
The Top Control Panel	8
The Rear Control Panel	10
The Viewfinder Display.....	12
The Shooting Information Display	14
The Command Dials	16
Quick Start Guide.....	23

Tutorial **25**

Camera Menus.....	26
Using Camera Menus	28
Help	31
First Steps	32
Charge the Battery	32
Insert the Battery	34
Attach a Lens.....	37
Basic Setup.....	39
Insert a Memory Card.....	42
Formatting Memory Cards.....	45
Adjust Viewfinder Focus	47
Basic Photography and Playback.....	48
Turn the Camera On	48
Adjust Camera Settings.....	51
Ready the Camera	54

Focus and Shoot.....	55
Viewing Photographs.....	57
Deleting Unwanted Photographs.....	58

Image Recording Options **59**

Image Area.....	60
Image Quality.....	66
Image Size.....	70
Slot 2.....	72

Focus **73**

Focus Mode.....	74
AF-Area Mode.....	76
Focus Point Selection.....	78
Focus Lock.....	80
Manual Focus.....	83

Release Mode **85**

Choosing a Release Mode.....	86
Continuous Mode.....	88
Framing Pictures in the Monitor (Live View).....	90
Self-Timer Mode.....	100
Mirror up Mode.....	102

ISO Sensitivity **103**

Choosing ISO Sensitivity Manually.....	104
Auto ISO Sensitivity Control.....	106

Exposure

109

Metering	110
Exposure Mode.....	112
<i>P</i> : Programmed Auto	114
<i>S</i> : Shutter-Priority Auto	116
<i>A</i> : Aperture-Priority Auto	118
<i>M</i> : Manual	120
Shutter-Speed and Aperture Lock.....	123
Autoexposure (AE) Lock.....	125
Exposure Compensation.....	128
Bracketing	130

White Balance

139

White Balance Options	140
Fine-Tuning White Balance.....	143
Choosing a Color Temperature	147
Preset Manual	148

Image Enhancement

161

Picture Controls.....	162
Creating Custom Picture Controls.....	170
Active D-Lighting.....	181
Color Space	183

Flash Photography

185

The Nikon Creative Lighting System (CLS)	186
Compatible Flash Units	187
CLS-Compatible Flash Units	187
Other Flash Units	191
i-TTL Flash Control.....	193
Flash Modes.....	194

FV Lock	198
Flash Contacts.....	201
Other Shooting Options	203
<hr/>	
Two-Button Reset: Restoring Default Settings	204
Multiple Exposure	206
Interval Timer Photography	211
Non-CPU Lenses.....	218
Using a GPS Unit	221
More About Playback	225
<hr/>	
Full-Frame Playback	226
Photo Information.....	229
Viewing Multiple Images: Thumbnail Playback	241
Taking a Closer Look: Playback Zoom.....	243
Protecting Photographs from Deletion.....	244
Deleting Individual Photographs	245
Voice Memos	247
<hr/>	
Recording Voice Memos	248
Playing Voice Memos.....	253
Connections	255
<hr/>	
Connecting to a Computer	256
Direct USB Connection	258
Wireless and Ethernet Networks	261
Printing Photographs.....	262
Direct USB Connection	263
Viewing Photographs on TV.....	274
Standard Definition Devices	274
High-Definition Devices	276

▶ The Playback Menu: Managing Images.....	278
Delete	281
Playback Folder.....	281
Hide Image	281
Display Mode.....	282
Copy Image(s)	283
Image Review	287
After Delete	287
Rotate Tall	287
Slide Show	288
Print Set (DPOF)	289
📷 The Shooting Menu: Shooting Options.....	290
Shooting Menu Bank	291
Reset Shooting Menu	293
Active Folder	293
File Naming	296
Slot 2.....	296
Image Quality	296
Image Size.....	297
Image Area	297
JPEG Compression.....	297
NEF (RAW) Recording	297
White Balance.....	297
Set Picture Control.....	298
Manage Picture Control.....	298
Color Space	298
Active D-Lighting	298
Vignette Control.....	299
Long Exp. NR (Long Exposure Noise Reduction)	300
High ISO NR.....	300
ISO Sensitivity Settings	301
Live View	301
Multiple Exposure	301
Interval Timer Shooting.....	301
🔧 Custom Settings: Fine-Tuning Camera Settings	302
📷: Custom Setting Bank.....	304

Ⓜ : Reset Custom Settings	304
a: Autofocus	305
a1: AF-C Priority Selection	305
a2: AF-S Priority Selection	306
a3: Dynamic AF Area	307
a4: Focus Tracking with Lock-On	309
a5: AF Activation	309
a6: Focus Point Illumination	310
a7: Focus Point Wrap-Around	311
a8: AF Point Selection	311
a9: AF-ON Button	312
a10: Vertical AF-ON Button	313
b: Metering/Exposure	314
b1: ISO Sensitivity Step Value	314
b2: EV Steps for Exposure Cntrl.	314
b3: EV Steps for Exposure Comp.	314
b4: Easy Exposure Compensation	315
b5: Center-Weighted Area	316
b6: Fine Tune Optimal Exposure	316
c: Timers/AE Lock	318
c1: Shutter-Release Button AE-L	318
c2: Auto Meter-off Delay	318
c3: Self-Timer Delay	319
c4: Monitor off Delay	319
d: Shooting/Display	320
d1: Beep	320
d2: Shooting Speed	321
d3: Max. Continuous Release	321
d4: File Number Sequence	322
d5: Control Panel/Viewfinder	323
d6: Shooting Info Display	324
d7: LCD Illumination	325
d8: Exposure Delay Mode	325
e: Bracketing/Flash	326
e1: Flash Sync Speed	326
e2: Flash Shutter Speed	327
e3: Modeling Flash	327
e4: Auto Bracketing Set	328
e5: Auto Bracketing (Mode M)	329

e6: Bracketing Order	330
f: Controls	331
f1: Multi Selector Center Button	331
f2: Multi Selector.....	332
f3: Photo Info/Playback.....	332
f4: Assign FUNC. Button.....	333
f5: Assign Preview Button	339
f6: Assign AE-L/AF-L Button	340
f7: Customize Command Dials	341
f8: Release Button to Use Dial.....	343
f9: No Memory Card?	344
f10: Reverse Indicators	345
Y The Setup Menu: Camera Setup.....	346
Format Memory Card	347
LCD Brightness.....	347
Lock Mirror up for Cleaning	347
Video Mode	348
HDMI.....	348
World Time	349
Language	349
Image Comment	350
Auto Image Rotation	351
Voice Memo	351
Voice Memo Overwrite	352
Voice Memo Button	352
Audio Output	352
USB.....	352
Dust off Ref Photo.....	353
Battery Info	355
Wireless Transmitter	356
Image Authentication	356
Copyright Information	357
Save/Load Settings.....	358
GPS	360
Virtual Horizon	360
Non-CPU Lens Data	360
AF Fine Tune	361
Firmware Version	362

☑ The Retouch Menu: Creating Retouched Copies	363
D-Lighting	366
Red-Eye Correction	367
Trim.....	368
Monochrome	369
Filter Effects	370
Color Balance	370
Image Overlay.....	371
Side-by-Side Comparison.....	374
☒ My Menu: Creating a Custom Menu	376
Adding Options to My Menu	376
Deleting Options from My Menu	378
Reordering Options in My Menu	379
Displaying Recent Settings.....	380

Technical Notes

381

Compatible Lenses	382
Other Accessories	387
Caring for the Camera.....	395
Storage.....	395
Cleaning	395
Replacing the Focusing Screen.....	396
Replacing the Clock Battery	398
The Low-Pass Filter	400
Caring for the Camera and Battery: Cautions.....	403
Troubleshooting	407
Error Messages	414
Appendix	421
Specifications	431
Index.....	442

For Your Safety

To prevent damage to your Nikon product or injury to yourself or to others, read the following safety precautions in their entirety before using this equipment. Keep these safety instructions where all those who use the product will read them.

The consequences that could result from failure to observe the precautions listed in this section are indicated by the following symbol:



This icon marks warnings. To prevent possible injury, read all warnings before using this Nikon product.

■ ■ WARNINGS

- ⚠ Keep the sun out of the frame**
Keep the sun well out of the frame when shooting backlit subjects. Sunlight focused into the camera when the sun is in or close to the frame could cause a fire.
- ⚠ Do not look at the sun through the viewfinder**
Viewing the sun or other strong light source through the viewfinder could cause permanent visual impairment.
- ⚠ Using the viewfinder diopter control**
When operating the viewfinder diopter control with your eye to the viewfinder, care should be taken not to put your finger in your eye accidentally.
- ⚠ Turn off immediately in the event of malfunction**
Should you notice smoke or an unusual smell coming from the equipment or AC adapter (available separately), unplug the AC adapter and remove the battery immediately, taking care to avoid burns. Continued operation could result in injury. After removing the battery, take the equipment to a Nikon-authorized service center for inspection.
- ⚠ Do not disassemble**
Touching the product's internal parts could result in injury. In the event of malfunction, the product should be repaired only by a qualified technician. Should the product break open as the result of a fall or other accident, remove the battery and/or AC adapter and then take the product to a Nikon-authorized service center for inspection.

⚠ Do not use in the presence of flammable gas
Do not use electronic equipment in the presence of flammable gas, as this could result in explosion or fire.

⚠ Keep out of reach of children
Failure to observe this precaution could result in injury.

⚠ Do not place the strap around the neck of an infant or child
Placing the camera strap around the neck of an infant or child could result in strangulation.

⚠ Observe proper precautions when handling batteries
Batteries may leak or explode if improperly handled. Observe the following precautions when handling batteries for use in this product:

- Use only batteries approved for use in this equipment.
- Use only CR1616 lithium batteries to replace the clock battery. Using another type of battery could cause an explosion. Dispose of used batteries as directed.
- Do not short or disassemble the battery.
- Be sure the product is off before replacing the battery. If you are using an AC adapter, be sure it is unplugged.
- Do not attempt to insert the battery upside down or backwards.
- Do not expose the battery to flame or to excessive heat.

- Do not immerse in or expose to water.
- Replace the terminal cover when transporting the battery. Do not transport or store the battery with metal objects such as necklaces or hairpins.
- Batteries are prone to leakage when fully discharged. To avoid damage to the product, be sure to remove the battery when no charge remains.
- When the battery is not in use, attach the terminal cover and store in a cool, dry place.
- The battery may be hot immediately after use or when the product has been used on battery power for an extended period. Before removing the battery turn the camera off and allow the battery to cool.
- Discontinue use immediately should you notice any changes in the battery, such as discoloration or deformation.

⚠ Observe proper precautions when handling the quick charger

- Keep dry. Failure to observe this precaution could result in fire or electric shock.
- Dust on or near the metal parts of the plug should be removed with a dry cloth. Continued use could result in fire.
- Do not handle the power cable or go near the charger during thunderstorms. Failure to observe this precaution could result in electric shock.
- Do not damage, modify, or forcibly tug or bend the power cable. Do not place it under heavy objects or expose it to heat or flame. Should the insulation be damaged and the wires become exposed, take the power cable to a Nikon-authorized service representative for inspection. Failure to observe this precaution could result in fire or electric shock.
- Do not handle the plug or charger with wet hands. Failure to observe this precaution could result in electric shock.
- Do not use with travel converters or adapters designed to convert from one voltage to another or with DC-to-AC inverters. Failure to observe this precaution could damage the product or cause overheating or fire.

⚠ Use appropriate cables

When connecting cables to the input and output jacks, use only the cables provided or sold by Nikon for the purpose to maintain compliance with product regulations.

⚠ CD-ROMs

CD-ROMs containing software or manuals should not be played back on audio CD equipment. Playing CD-ROMs on an audio CD player could cause hearing loss or damage the equipment.

⚠ Observe caution when using a flash

- Using optional flash units in close contact with the skin or other objects could cause burns.
- Using optional flash units close to the subject's eyes could cause temporary visual impairment. Particular care should be observed when photographing infants, when the flash should be no less than one meter (39 in.) from the subject.

⚠ Avoid contact with liquid crystal

Should the monitor break, care should be taken to avoid injury due to broken glass and to prevent the liquid crystal from the monitor touching the skin or entering the eyes or mouth.

Notices

- No part of the manuals included with this product may be reproduced, transmitted, transcribed, stored in a retrieval system, or translated into any language in any form, by any means, without Nikon's prior written permission.
- Nikon reserves the right to change the specifications of the hardware and software described in these manuals at any time and without prior notice.
- Nikon will not be held liable for any damages resulting from the use of this product.
- While every effort has been made to ensure that the information in these manuals is accurate and complete, we would appreciate it were you to bring any errors or omissions to the attention of the Nikon representative in your area (address provided separately).

Notices for Customers in the U.S.A.

Federal Communications Commission (FCC) Radio Frequency Interference Statement

This equipment has been tested and found to comply with the limits for a Class B digital device, pursuant to Part 15 of the FCC rules. These limits are designed to provide reasonable protection against harmful interference in a residential installation. This equipment generates, uses, and can radiate radio frequency energy and, if not installed and used in accordance with the instructions, may cause harmful interference to radio communications. However, there is no guarantee that interference will not occur in a particular installation. If this equipment does cause harmful interference to radio or television reception, which can be determined by turning the equipment off and on, the user is encouraged to try to correct the interference by one or more of the following measures:

- Reorient or relocate the receiving antenna.
- Increase the separation between the equipment and receiver.
- Connect the equipment into an outlet on a circuit different from that to which the receiver is connected.
- Consult the dealer or an experienced radio/television technician for help.



CAUTIONS

Modifications

The FCC requires the user be notified that any changes or modifications made to this device that are not expressly approved by Nikon Corporation may void the user's authority to operate the equipment.

Interface Cables

Use the interface cables sold or provided by Nikon for your equipment. Using other interface cables may exceed the limits of Class B Part 15 of the FCC rules.

Notice for Customers in the State of California

WARNING: Handling the cord on this product may expose you to lead, a chemical known to the State of California to cause birth defects or other reproductive harm. *Wash hands after handling.*

Nikon Inc., 1300 Walt Whitman Road,
Melville, New York 11747-3064, U.S.A.
Tel.: 631-547-4200

Notices for Customers in Canada

CAUTION

This Class B digital apparatus complies with Canadian ICES-003.

Notice for Customers in Europe

This symbol indicates that this product is to be collected separately.



The following apply only to users in European countries:

- This product is designated for separate collection at an appropriate collection point. Do not dispose of as household waste.
- For more information, contact the retailer or the local authorities in charge of waste management.

ATTENTION

Cet appareil numérique de la classe B est conforme à la norme NMB-003 du Canada.

This symbol on the battery indicates that the battery is to be collected separately.



The following apply only to users in European countries:

- All batteries, whether marked with this symbol or not, are designated for separate collection at an appropriate collection point. Do not dispose of as household waste.
- For more information, contact the retailer or the local authorities in charge of waste management.

Disposing of Data Storage Devices

Please note that deleting images or formatting memory cards or other data storage devices does not completely erase the original image data. Deleted files can sometimes be recovered from discarded storage devices using commercially available software, potentially resulting in the malicious use of personal image data. Ensuring the privacy of such data is the user's responsibility.

Before discarding a data storage device or transferring ownership to another person, erase all data using commercial deletion software, or format the device and then completely refill it with images containing no private information (for example, pictures of empty sky). Be sure to also replace any pictures selected for preset manual. Care should be taken to avoid injury when physically destroying data storage devices.

Notice Concerning Prohibition of Copying or Reproduction

Note that simply being in possession of material that has been digitally copied or reproduced by means of a scanner, digital camera, or other device may be punishable by law.

• Items prohibited by law from being copied or reproduced

Do not copy or reproduce paper money, coins, securities, government bonds, or local government bonds, even if such copies or reproductions are stamped "Sample."

The copying or reproduction of paper money, coins, or securities which are circulated in a foreign country is prohibited.

Unless the prior permission of the government has been obtained, the copying or reproduction or unused postage stamps or post cards issued by the government is prohibited.

The copying or reproduction of stamps issued by the government and of certified documents stipulated by law is prohibited.

• Cautions on certain copies and reproductions

The government has issued cautions on copies or reproductions of securities issued by private companies (shares, bills, checks, gift certificates, etc.), commuter passes, or coupon tickets, except when a minimum of necessary copies are to be provided for business use by a company. Also, do not copy or reproduce passports issued by the government, licenses issued by public agencies and private groups, ID cards, and tickets, such as passes and meal coupons.

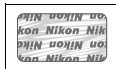
• Comply with copyright notices

The copying or reproduction of copyrighted creative works such as books, music, paintings, woodcuts, prints, maps, drawings, movies, and photographs is governed by national and international copyright laws. Do not use this product for the purpose of making illegal copies or to infringe copyright laws.

Use Only Nikon Brand Electronic Accessories

Nikon cameras are designed to the highest standards and include complex electronic circuitry. Only Nikon brand electronic accessories (including battery chargers, batteries, AC adapters, and flash accessories) certified by Nikon specifically for use with this Nikon digital camera are engineered and proven to operate within the operational and safety requirements of this electronic circuitry.

The use of non-Nikon electronic accessories could damage the camera and may void your Nikon warranty. The use of third-party rechargeable Li-ion batteries not bearing the Nikon holographic seal shown at right could interfere with normal operation of the camera or result in the batteries overheating, igniting, rupturing, or leaking.



For more information about Nikon brand accessories, contact a local authorized Nikon dealer.

Before Taking Important Pictures

Before taking pictures on important occasions (such as at weddings or before taking the camera on a trip), take a test shot to ensure that the camera is functioning normally. Nikon will not be held liable for damages or lost profits that may result from product malfunction.

Life-Long Learning

As part of Nikon's "Life-Long Learning" commitment to ongoing product support and education, continually-updated information is available online at the following sites:

- **For users in the U.S.A.:** <http://www.nikonusa.com/>
- **For users in Europe and Africa:** <http://www.europe-nikon.com/support>
- **For users in Asia, Oceania, and the Middle East:** <http://www.nikon-asia.com/>

Visit these sites to keep up-to-date with the latest product information, tips, answers to frequently-asked questions (FAQs), and general advice on digital imaging and photography. Additional information may be available from the Nikon representative in your area. See the following URL for contact information: <http://imaging.nikon.com/>



Introduction



This chapter covers information you will need to know before using the camera, including the names of camera parts.

Overview	pg. 2
Getting to Know the Camera	pg. 3
Camera Body	pg. 3
The Top Control Panel	pg. 8
The Rear Control Panel	pg. 10
The Viewfinder Display	pg. 12
The Shooting Information Display	pg. 14
The Command Dials	pg. 16
Quick Start Guide	pg. 23

Overview

Thank you for your purchase of a Nikon single-lens reflex (SLR) digital camera. Please be sure to read all instructions thoroughly to get the most from the camera, and keep them where they will be read by all those who use the product.



✔ Use Only Nikon Brand Accessories

Only Nikon brand accessories certified by Nikon specifically for use with your Nikon digital camera are engineered and proven to operate within its operational and safety requirements. THE USE OF NON-NIKON ACCESSORIES COULD DAMAGE YOUR CAMERA AND MAY VOID YOUR NIKON WARRANTY.

✔ Servicing the Camera and Accessories

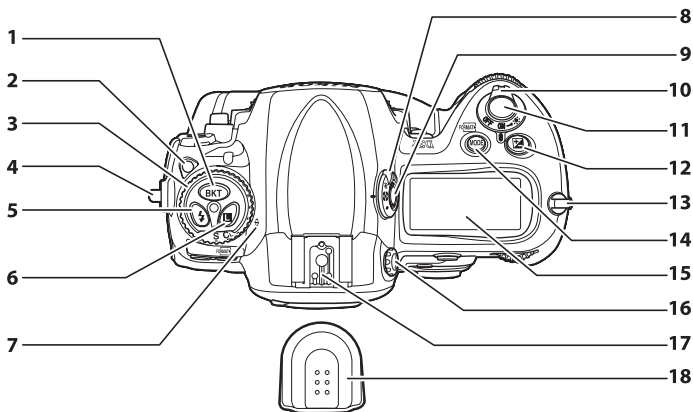
The camera is a precision device and requires regular servicing. Nikon recommends that the camera be inspected by the original retailer or a Nikon-authorized service representative once every one to two years, and that it be serviced once every three to five years (note that fees apply to these services). Frequent inspection and servicing are particularly recommended if the camera is used professionally. Any accessories regularly used with the camera, such as lenses or optional flash units, should be included when the camera is inspected or serviced.






Getting to Know the Camera

Take a few moments to familiarize yourself with camera controls and displays. You may find it helpful to bookmark this section and refer to it as you read through the rest of the manual.

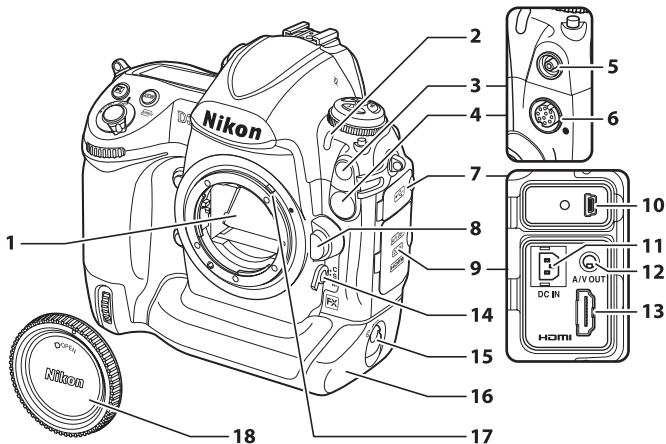


Camera Body

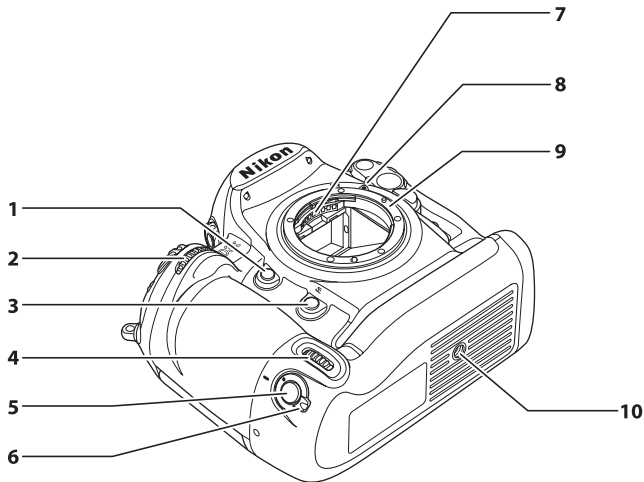


- | | |
|---|--|
| 1 BKT (bracketing) button 131, 135, 328 | 11 Shutter-release button 55, 56 |
| 2 Release mode dial lock release 87 | 12  (exposure compensation) button 128 |
| 3 Release mode dial 87 | 13 Eyelet for camera strap 5 |
| 4 Eyelet for camera strap 5 | 14 MODE (exposure mode) button 113 |
| 5  (flash mode) button 196 |  (format) button 45 |
| 6  (command lock) button 123, 124 | 15 Top control panel 8 |
| 7 Focal plane mark () 84 | 16 Diopter adjustment knob 47 |
| 8 Metering selector 111 | 17 Accessory shoe 22, 201
(for optional flash unit) |
| 9 Metering selector lock button 111 | 18 Accessory shoe cover
..... 22, 201, 405 |
| 10 Power switch 48 | |

Camera Body (Continued)



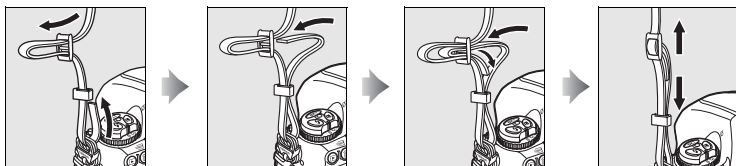
- | | |
|--|--|
| 1 Mirror.....90, 102, 400 | 10 USB connector 258, 264 |
| 2 Self-timer lamp 101 | 11 DC-IN connector for optional AC adapter EH-6.....387 |
| 3 Flash sync terminal cover..... 201 | 12 Audio/video (A/V) connector274 |
| 4 Ten-pin remote terminal cover221, 392 | 13 HDMI connector.....276 |
| 5 Flash sync terminal..... 201 | 14 Focus-mode selector..... 74, 83 |
| 6 Ten-pin remote terminal221, 392 | 15 Battery-cover latch.....34 |
| 7 USB connector cover258, 264 | 16 Battery-chamber cover.....34 |
| 8 Lens release button.....38 | 17 Meter coupling lever433 |
| 9 Connector cover.....274, 276 | 18 Body cap391 |



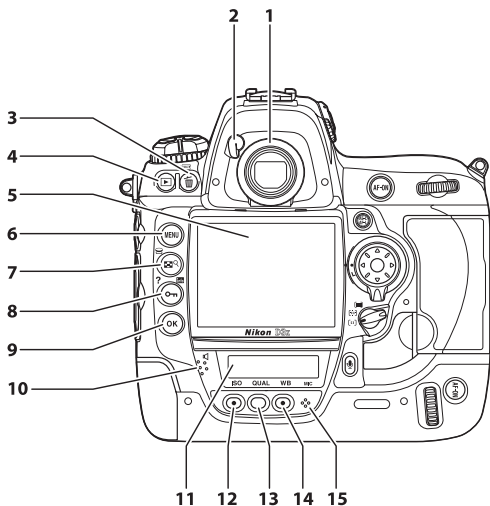
- | | |
|---|--|
| <p>1 Depth-of-field preview button 113, 339</p> <p>2 Sub-command dial 16</p> <p>3 Fn button 64, 199, 333</p> <p>4 Sub-command dial for vertical shooting 16</p> <p>5 Shutter-release button for vertical shooting 54</p> | <p>6 Vertical shooting shutter-release button lock 54</p> <p>7 CPU contacts</p> <p>8 Mounting index 37</p> <p>9 Lens mount 84</p> <p>10 Tripod socket</p> |
|---|--|

■ ■ Attaching the Camera Strap

Attach the camera strap securely to the two eyelets on the camera body as shown below.



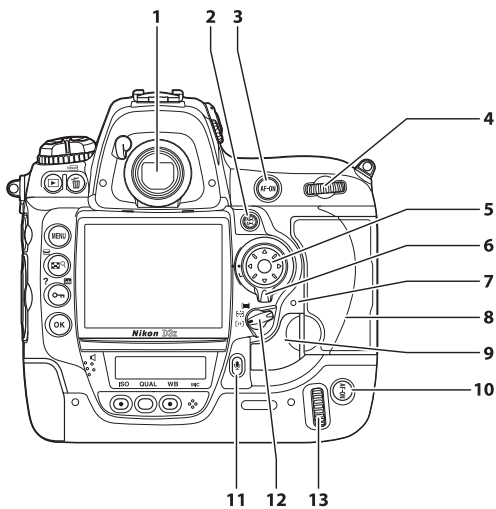
Camera Body (Continued)



1 Viewfinder eyepiece.....	47	9 (OK) button.....	28
2 Eyepiece shutter lever.....	47	10 Speaker.....	254
3 (delete) button.....	58, 245	11 Rear control panel.....	10, 323
(format) button.....	45	12 ISO (ISO sensitivity) button.....	104
4 (playback) button.....	57, 226	Two-button reset button.....	204
5 Monitor.....	57, 90, 226	13 QUAL (image quality/size)	
6 MENU (menu) button.....	26, 277	button.....	67, 71
7 (thumbnail/playback		14 WB (white balance)	
zoom) button.....	242, 243	button.....	141, 146, 147
8 (protect) button.....	244	Two-button reset button.....	204
? (help) button.....	31	15 Microphone.....	248
(info) button.....	14		

The Speaker and Microphone

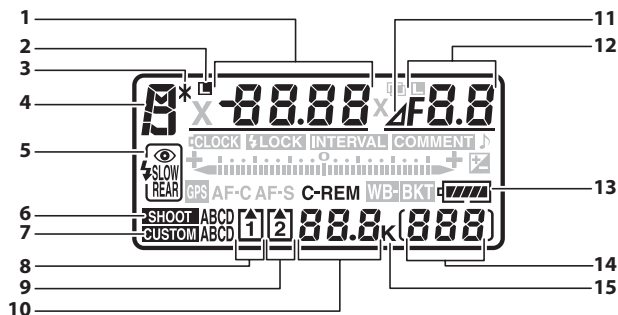
Do not bring magnetic devices, such as microdrive cards, close to the built-in speaker or microphone.



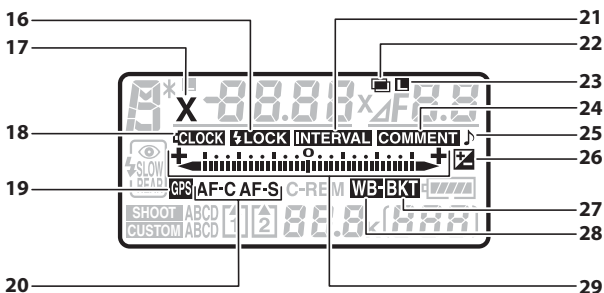
- | | | | |
|--|-------------|--|-----|
| 1 Viewfinder | 47 | 9 Card slot cover release button
(under cover) | 42 |
| 2 AE-L
AF-L (AE/AF lock) button
..... | 80, 81, 340 | 10 AF-ON (AF-ON) button for
vertical shooting | 313 |
| 3 AF-ON (AF-ON) button | 75, 94 | 11 M (microphone) button | 249 |
| 4 Main command dial | 16 | 12 AF-area mode selector | 76 |
| 5 Multi selector | 28 | 13 Main command dial for
vertical shooting | 16 |
| 6 Focus selector lock | 78 | | |
| 7 Memory card access lamp..... | 43, 56 | | |
| 8 Memory card slot cover | 42, 44 | | |



The Top Control Panel



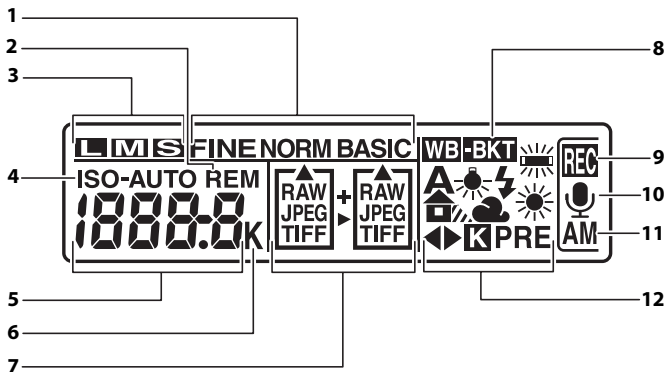
- | | |
|--|--|
| <p>1 Shutter speed 116, 120
Exposure compensation value 128
Number of shots in exposure and flash bracketing sequence 131
Number of shots in WB bracketing sequence 135
Number of intervals for interval timer photography 214
Focal length (non-CPU lenses) 220
ISO sensitivity 104</p> <p>2 Shutter-speed lock icon 123</p> <p>3 Flexible program indicator ... 115</p> <p>4 Exposure mode 112</p> <p>5 Flash mode 194</p> <p>6 Shooting menu bank 291</p> <p>7 Custom settings bank 304</p> <p>8 Memory card indicator (slot 1) 42, 45</p> | <p>9 Memory card indicator (slot 2) 42, 45</p> <p>10 Number of exposures remaining 49
Number of shots remaining before memory buffer fills 88
Capture mode indicator 256</p> <p>11 Aperture stop indicator .. 119, 385</p> <p>12 Aperture (f-number) 118, 120
Aperture (number of stops) 119, 385
Exposure and flash bracketing increment 132
WB bracketing increment 136
Number of shots per interval 214
Maximum aperture (non-CPU lenses) 220
PC mode indicator 259</p> |
|--|--|





13 Battery indicator.....	48	24 Image comment indicator	350
14 Frame count.....	49	25 "Beep" indicator	320
Preset white balance		26 Exposure compensation	
recording indicator.....	151	indicator.....	128
Manual lens number.....	220	27 Exposure and flash bracketing	
15 "K" (appears when memory		indicator.....	131
remains for over 1000		28 White-balance bracketing	
exposures)	49	indicator.....	135
16 FV lock indicator	199	29 Electronic analog exposure	
17 Flash sync indicator.....	326	display	122
18 Clock battery indicator ...	41, 398	Exposure compensation	128
19 GPS connection indicator	223	Exposure and flash bracketing	
20 Focus mode indicator.....	74	progress indicator	131
21 Interval timer indicator	214	WB bracketing progress	
22 Multiple exposure		indicator.....	135
indicator.....	208	PC connection indicator	259
23 Aperture lock icon	124	Tilt indicator.....	335



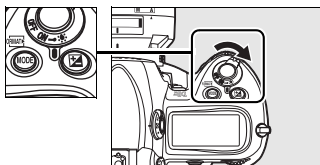
The Rear Control Panel



LCD Illuminators

Holding the power switch in the  position activates the exposure meters and the control panel backlights (LCD illuminators), allowing the displays to be read in the dark. After the power switch is released, the illuminators will remain lit for six seconds (at default settings) while the exposure meters are active or until the shutter is released or the power switch is rotated to the  position again.

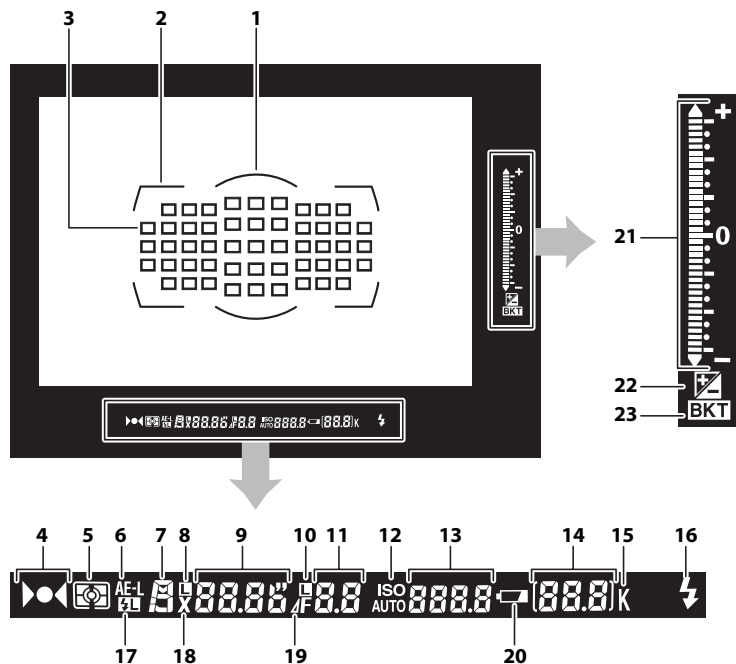
Power switch



1	Image quality (JPEG images) ..67	6	“K” (appears when memory remains for over 1000 exposures)..... 49
2	“Remaining” indicator49		Color temperature indicator147
3	Image size71	7	Memory card slot indicators... 72
4	ISO sensitivity indicator 104		Image quality 67
	Auto ISO sensitivity indicator 106	8	White-balance bracketing indicator135
5	ISO sensitivity 104	9	Voice memo recording indicator (shooting mode)249
	ISO sensitivity (high/low gain) 105	10	Voice memo status indicator 251, 252
	Number of exposures remaining49	11	Voice memo recording mode249
	Length of voice memo 251	12	White balance 140
	White balance fine-tuning.... 146		White balance fine-tuning indicator146
	White balance preset number 158		
	Color temperature 147		
	PC mode indicator 259		



The Viewfinder Display



- | | |
|---|---|
| <p>1 12-mm reference circle for center-weighted metering ... 110</p> <p>2 AF area brackets47, 92</p> <p>3 Focus points.....78, 311
Spot metering targets 110</p> <p>4 Focus indicator.....55, 84</p> <p>5 Metering..... 110</p> <p>6 Autoexposure (AE) lock 125</p> | <p>7 Exposure mode 112</p> <p>8 Shutter speed lock icon.....123</p> <p>9 Shutter-speed 116, 120</p> <p>10 Aperture lock icon124</p> <p>11 Aperture (f-number) 118, 120
Aperture
(number of stops) 119, 385</p> |
|---|---|

12	ISO sensitivity indicator	104	16	Flash-ready indicator *	199
	Auto ISO sensitivity		17	FV lock indicator	199
	indicator	106	18	Flash sync indicator	326
13	ISO sensitivity	104	19	Aperture stop indicator ..	119, 385
14	Frame count	49	20	Battery indicator	48
	Number of exposures		21	Electronic analog exposure	
	remaining	49		display	122
	Number of shots remaining			Exposure compensation display	
	before memory buffer fills	88		128
	Preset white balance			Tilt indicator.....	335
	recording indicator.....	151	22	Exposure compensation	
	Exposure compensation			indicator.....	128
	value	128	23	Exposure and flash bracketing	
	PC mode indicator.....	259		indicator.....	131
15	"K" (appears when memory				
	remains for over 1000				
	exposures)	49			



* Displayed when an optional flash unit is attached (pg. 187). The flash-ready indicator lights when the flash is charged.

✓ No Battery

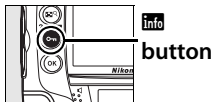
When the battery is totally exhausted or no battery is inserted, the display in the viewfinder will dim. This is normal and does not indicate a malfunction. The viewfinder display will return to normal when a fully-charged battery is inserted.

✓ The Control Panel and Viewfinder Displays

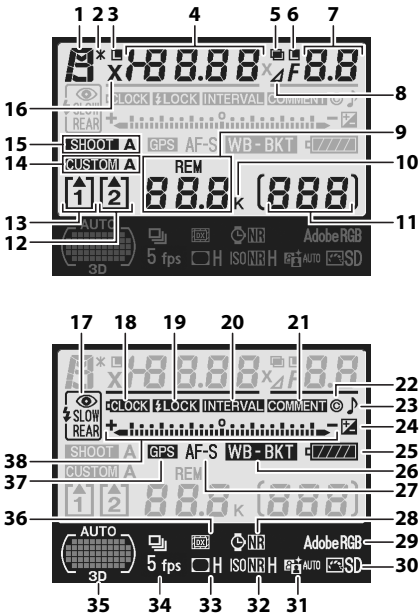
The brightness of the control panel and viewfinder displays varies with temperature, and the response times of the displays may drop at low temperatures. This is normal and does not indicate a malfunction.

The Shooting Information Display

Shooting information, including shutter speed, aperture, the number of exposures remaining, and AF-area mode is displayed in the monitor when the **info** button is pressed.



To clear shooting information from the monitor, press the **info** button again or press the shutter-release button halfway. At default settings, the monitor will turn off automatically if no operations are performed for about 20 seconds.



See Also

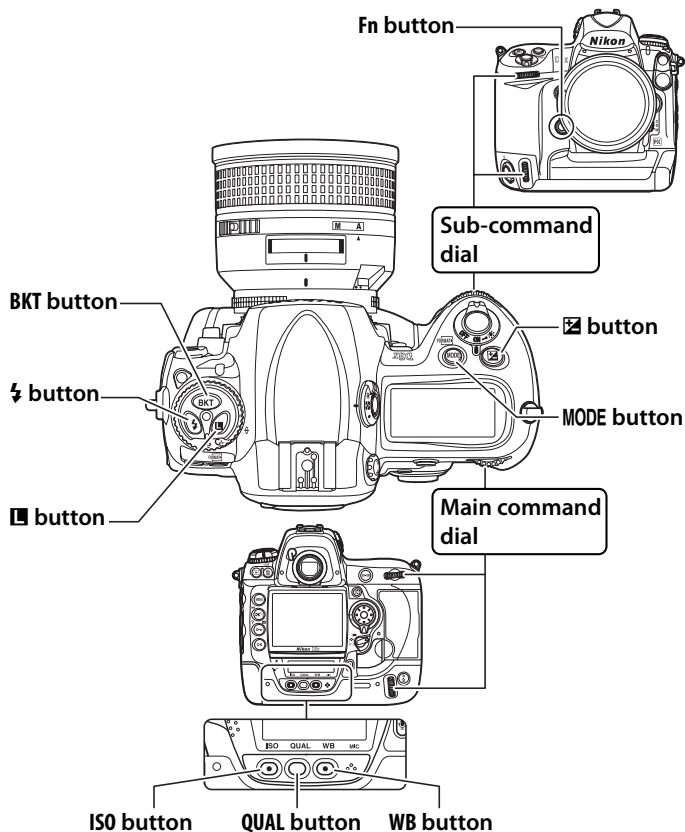
For information on choosing how long the monitor stays on, see Custom Setting c4 ([Monitor off delay], pg. 319). For information on changing the color of the lettering in the shooting information display, see Custom Setting d6 ([Shooting info display], pg. 324).

1	Exposure mode.....	112	16	Flash sync indicator	326
2	Flexible program indicator ...	115	17	Flash mode.....	194
3	Shutter-speed lock icon.....	123	18	Clock battery indicator	41, 398
4	Shutter speed	116, 120	19	FV lock indicator	199
	Exposure compensation		20	Interval timer indicator.....	214
	value	128	21	Image comment indicator	350
	Number of shots in exposure		22	Copyright information	
	and flash bracketing sequence			indicator.....	357
	131	23	“Beep” indicator	320
	Number of shots in WB		24	Exposure compensation	
	bracketing sequence	135		indicator.....	128
	Focal length		25	Battery indicator	48
	(non-CPU lenses).....	220	26	Exposure and flash bracketing	
5	Multiple exposure indicator....	208		indicator.....	131
6	Aperture lock icon	124		WB bracketing indicator	135
7	Aperture (f-number)	118, 120	27	Focus mode indicator	74
	Aperture		28	Long exposure noise reduction	
	(number of stops)	119, 385		indicator.....	300
	Exposure and flash bracketing		29	Color space indicator	183
	increment	132	30	Picture Control indicator.....	165
	WB bracketing increment	136	31	Active D-Lighting indicator...	181
	Maximum aperture		32	High ISO noise reduction	
	(non-CPU lenses).....	220		indicator.....	300
8	Aperture stop indicator...	119, 385	33	Vignette control	299
9	Number of exposures		34	Release mode (single frame/	
	remaining	49		continuous) indicator.....	86
10	“K” (appears when memory			Continuous shooting speed....	321
	remains for over 1000		35	Auto-area AF indicator	77
	exposures)	49		Focus points indicator	78
11	Frame count.....	49		AF-area mode indicator	77
	Manual lens number.....	220		3D-tracking indicator	77, 308
12	Memory card indicator		36	Image area indicator	61
	(slot 2).....	42, 45	37	GPS connection indicator.....	223
13	Memory card indicator		38	Electronic analog exposure	
	(slot 1).....	42, 45		display	122
14	Custom settings bank.....	304			
15	Shooting menu bank.....	291			



The Command Dials

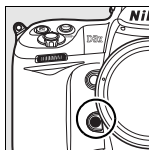
The main- and sub-command dials are used alone or in combination with other controls to adjust a variety of settings.



■ Image Quality and Size

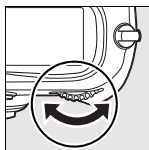
Press the **Fn** or **QUAL** button and rotate the command dials.

Choose an image area (pg. 64)*

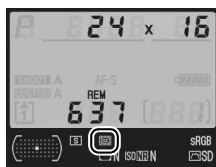


Fn button

+



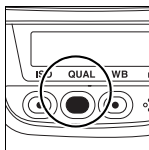
Main command dial



Shooting information display

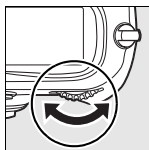
* The DX format image area is automatically selected when a DX lens is attached.

Set image quality (pg. 67)

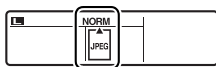


QUAL button

+

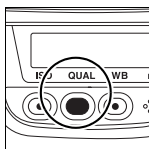


Main command dial



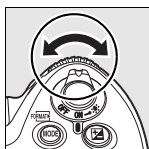
Rear control panel

Choose an image size (pg. 71)

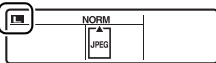


QUAL button

+



Sub-command dial

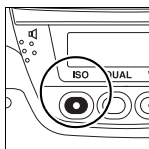


Rear control panel

■ ISO Sensitivity

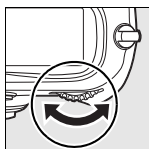
Press the **ISO** button and rotate the main command dial.

Set ISO sensitivity (pg. 104)



ISO button

+



Main command dial

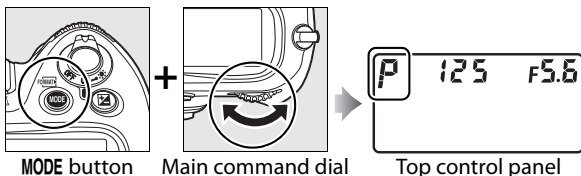


Rear control panel

■ Exposure

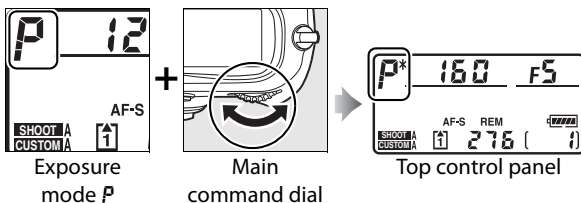
Press the **MODE** button and rotate the main command dial to choose the exposure mode.

Choose the exposure mode (pg. 113)

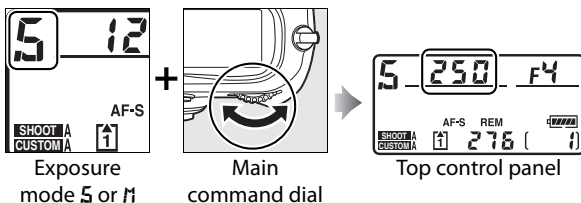


Use the command dials to adjust exposure.

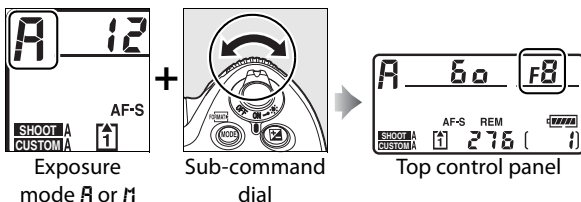
Choose a combination of aperture and shutter speed (exposure mode *P*; pg. 115)



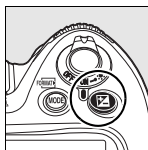
Choose a shutter speed (exposure mode *S* or *M*; pg. 116, 121)



Choose an aperture (exposure mode *A* or *M*; pg. 118, 121)

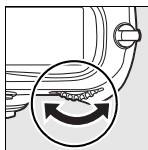


Set exposure compensation (pg. 128)



 button

+

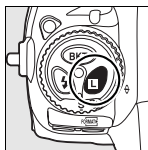


Main command dial



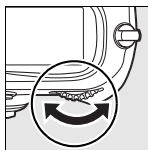
Top control panel

Shutter speed lock (exposure mode S or M; pg. 123)

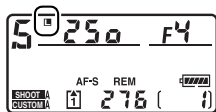


 button

+

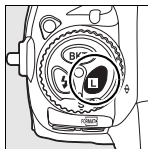


Main command dial



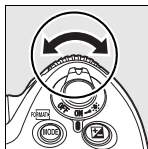
Top control panel

Aperture lock (exposure mode A or M; pg. 124)

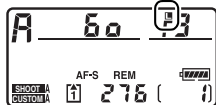


 button

+



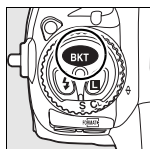
Sub-command dial



Top control panel

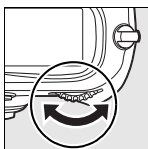


Activate or cancel bracketing/
select number of shots in
bracketing sequence (pp.
131, 134)

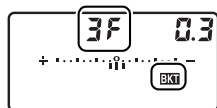


BKT button

+

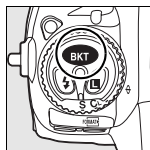


Main command dial



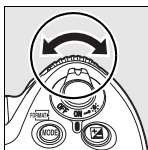
Top control panel

Select
bracketing
exposure
increment (pg.
132)

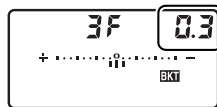


BKT button

+



Sub-command dial

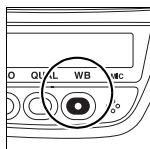


Top control panel

■ ■ White Balance

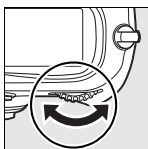
Press the **WB** button and rotate the command dials.

Choose a white
balance setting
(pg. 141)

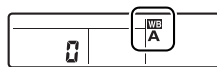


WB button

+

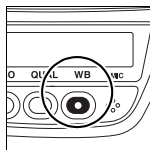


Main command dial



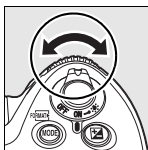
Rear control panel

Fine-tune
white balance
(pg. 146), set
color
temperature
(pg. 147), or
choose a white
balance preset
(pg. 158)

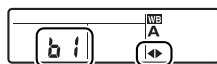


WB button

+



Sub-command dial

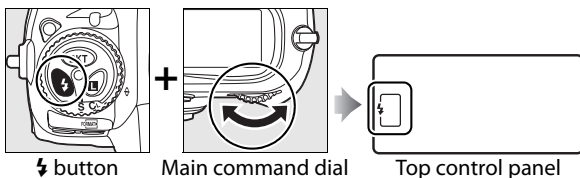


Rear control panel

■ Flash Settings

Press the  button and rotate the main command dial.

Choose flash mode (pg. 196)



✎ The Fn Button

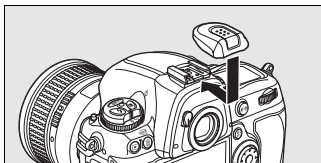
Depending on the option selected for Custom Setting f4 ([Assign FUNC. button], pg. 333), the **Fn** button and command dials can be used to select from FX, DX, and 5 : 4 image areas, toggle between FX and DX image areas, select shutter speed and aperture in steps of 1 EV, choose pre-specified lens data for non-CPU lenses, select the focus point, choose a shooting menu bank, or select the number of focus points for dynamic-area AF.

✎ The Depth-of-Field Preview and AE-L/AF-L Buttons

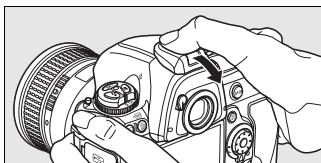
Depending on the options selected for Custom Settings f5 ([Assign preview button], pg. 339) and f6 ([Assign AE-L/AF-L button], pg. 340), the depth-of-field preview and **AE-L/AF-L** buttons can be used with the command dials to perform the same functions as the **Fn** button.

The BS-2 Accessory Shoe Cover

The supplied BS-2 accessory shoe cover can be used to protect the accessory shoe or to prevent light reflected from the metal parts of the shoe from appearing in photographs. The BS-2 attaches to the camera accessory shoe as shown at right.



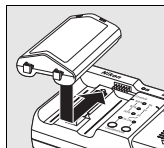
To remove the accessory shoe cover, hold it down with your thumb and slide it off as shown at right while keeping a firm grip on the camera.



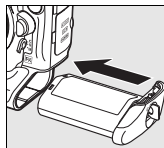
Quick Start Guide

Follow these steps for a quick start with the D3X.

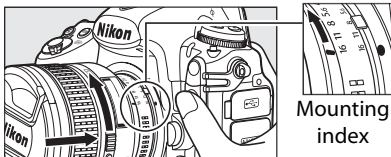
1 Charge the battery (pg. 32).



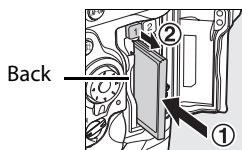
2 Insert the battery (pg. 34).



3 Attach a lens (pg. 37).

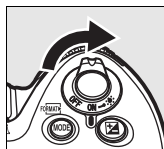


4 Insert a memory card (pg. 42).

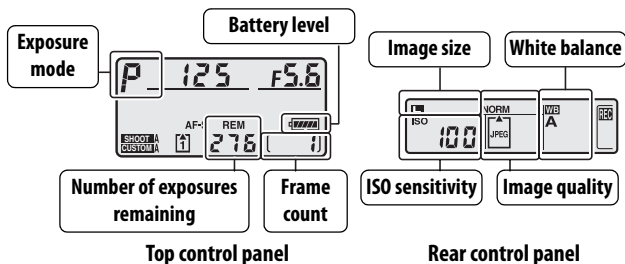


5 Turn the camera on (pg. 48).

For information on choosing a language and setting the time and date, see page 39. See page 47 for information on adjusting viewfinder focus.



6 Check camera settings (pp. 48, 51).

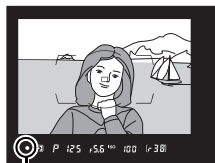


7 Select single-servo autofocus (pg. 53, 74).

Rotate the focus-mode selector to **S** (single-servo autofocus).

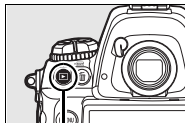
8 Focus and shoot (pp. 55, 56).

Press the shutter-release button halfway to focus, then press the shutter-release button the rest of the way down to take the photograph.



Focus indicator

9 View the photograph (pg. 57).

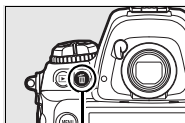


▶ button



10 Delete unwanted photos (pg. 58).

Press twice to delete the current photograph.



button





Tutorial



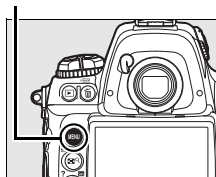
This section describes how to use the camera menus, how to ready the camera for use, and how to take your first pictures and play them back.

Camera Menus	pg. 26
Using Camera Menus	pg. 28
Help	pg. 31
First Steps	pg. 32
Charge the Battery	pg. 32
Insert the Battery	pg. 34
Attach a Lens	pg. 37
Basic Setup	pg. 39
Insert a Memory Card.....	pg. 42
Formatting Memory Cards	pg. 45
Adjust Viewfinder Focus.....	pg. 47
Basic Photography and Playback.....	pg. 48
Turn the Camera On	pg. 48
Adjust Camera Settings.....	pg. 51
Ready the Camera	pg. 54
Focus and Shoot	pg. 55
Viewing Photographs.....	pg. 57
Deleting Unwanted Photographs	pg. 58

Camera Menu

Most shooting, playback, and setup options can be accessed from the camera menu. To view the menus, press the **MENU** button.

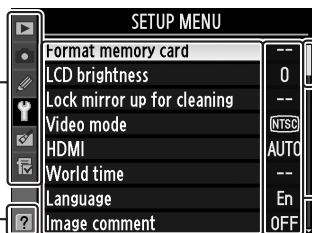
MENU button



Tabs

Choose from playback, shooting, Custom Settings, setup, retouch, and My menus (see following page).

Slider shows position in current menu.









Current settings are shown by icons.

?
If "?" icon is displayed, help for current item can be viewed by pressing **Fn (?)** button (pg. 31).

Menu options
Options in current menu.

■ ■ **Menus**

The following menus are available:

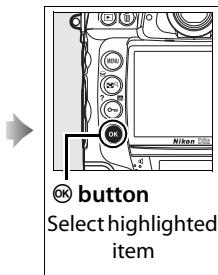
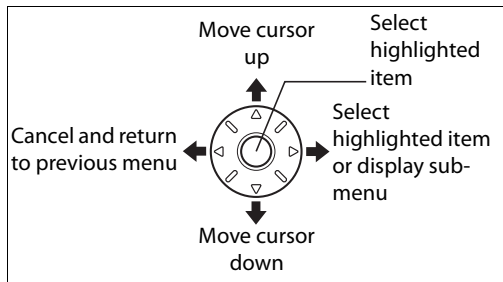
Menu	Description
 Playback	Adjust playback settings and manage photos (pg. 278).
 Shooting	Adjust shooting settings (pg. 290).
 Custom Settings	Personalize camera settings (pg. 302).
 Setup	Format memory cards and perform basic camera setup (pg. 346).
 Retouch	Create retouched copies of existing photographs (pg. 363).
 My Menu	Create a menu of custom options (pg. 376). If desired, a menu of recently-used settings can be displayed in place of [My Menu] (pg. 380).



Using Camera Menus

Menu Controls

The multi selector and **OK** button are used to navigate the menus.



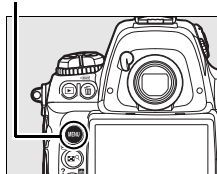
Navigating the Menus

Follow the steps below to navigate the menus.

1 Display the menus.

Press the **MENU** button to display the menus.

MENU button



2 Highlight the icon for the current menu.

Press **◀** to highlight the icon for the current menu.



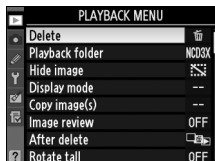
3 Select a menu.

Press ▲ or ▼ to select the desired menu.



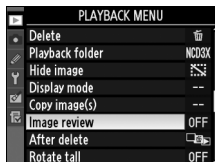
4 Position the cursor in the selected menu.

Press ► to position the cursor in the selected menu.



5 Highlight a menu item.

Press ▲ or ▼ to highlight a menu item.



6 Display options.

Press ► to display options for the selected menu item.



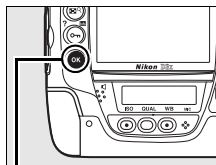
7 Highlight an option.

Press ▲ or ▼ to highlight an option.

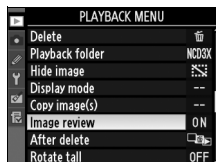


8 Select the highlighted item.

Press **OK** to select the highlighted item.
To exit without making a selection, press the **MENU** button.



OK button

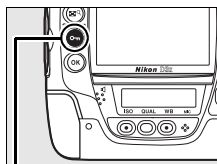
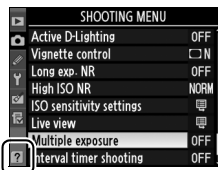


Note the following points:

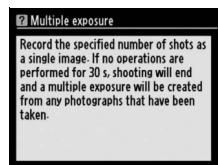
- Menu items that are displayed in gray are not currently available.
- While pressing **▶** or the center of the multi selector generally has the same effect as pressing **OK**, there are some cases in which selection can only be made by pressing **OK**.
- To exit the menus and return to shooting mode, press the shutter-release button halfway (pg. 56).

Help

If a ? icon is displayed at the bottom left corner of the monitor, help can be displayed by pressing the **OK (?)** button. A description of the currently selected option or menu will be displayed while the button is pressed. Press **▲** or **▼** to scroll through the display.



OK (?) button



First Steps

Charge the Battery

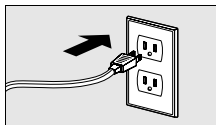
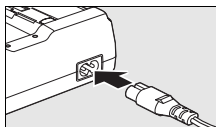
The D3X is powered by an EN-EL4a rechargeable Li-ion battery (supplied).



The EN-EL4a is not fully charged at shipment. To maximize shooting time, charge the battery in the supplied MH-22 quick charger before use. About two hours and twenty-five minutes are required to fully recharge the battery when no charge remains.

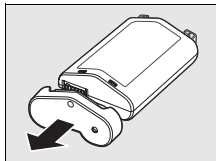
1 Plug the charger in.

Insert the AC adapter plug into the battery charger and plug the power cable into an electrical outlet. All lamps will remain off.



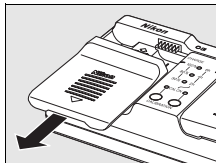
2 Remove the terminal cover.

Remove the terminal cover from the battery.

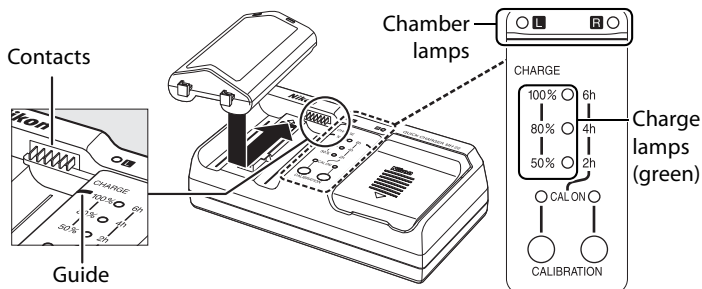


3 Remove the contact protector.

Remove the contact protector of the quick charger's battery chambers.



4 Charge the battery.



Insert the battery (terminals first), aligning the end of the battery with the guide and then sliding the battery in the direction indicated until it clicks into place. The chamber lamp and charge lamps will blink while the battery charges:

Charge state	Chamber lamp	Charge lamps		
		50%	80%	100%
Less than 50% of maximum capacity	⚡ (blinks)	⚡ (blinks)	● (off)	● (off)
50–80% of maximum capacity	⚡ (blinks)	○ (glows)	⚡ (blinks)	● (off)
More than 80% but less than 100% of maximum capacity	⚡ (blinks)	○ (glows)	○ (glows)	⚡ (blinks)
100% of maximum capacity	○ (glows)	● (off)	● (off)	● (off)

Charging is complete when the chamber lamp stops blinking and the charge lamps turn off. About two hours and twenty-five minutes are required to fully charge an exhausted battery.

5 Remove the battery when charging is complete.

Remove the battery and unplug the charger.

Calibration

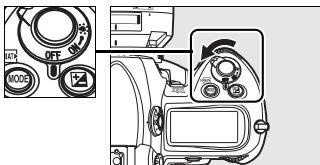
See page 437 for more information on calibration.

Insert the Battery

1 Turn the camera off.

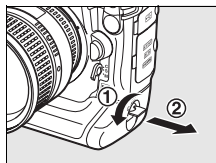
Always turn the camera off before inserting or removing batteries.

Power switch



2 Remove the battery-chamber cover.

Lift the battery-chamber cover latch, turn it to the open (Ⓢ) position (1) and remove the BL-4 battery-chamber cover (2).

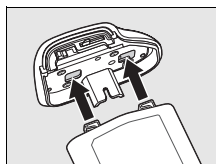
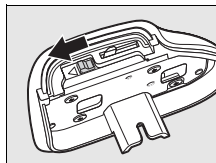


3 Attach the cover to the battery.

If the battery release is positioned so that the arrow (◀) is visible, slide the battery release to cover the arrow. Insert the two projections on the battery into the matching slots in the cover and slide the battery release to reveal the arrow.

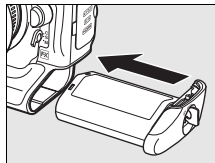
The BL-4 Battery-Chamber Cover

The battery can be charged with the BL-4 attached. To prevent dust from accumulating inside the battery chamber when the battery is not inserted, slide the battery release in the direction indicated by the arrow (◀), remove the BL-4 from the battery, and replace it on the camera.



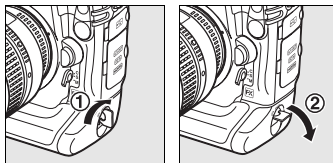
4 Insert the battery.

Insert the battery as shown at right.



5 Latch the cover.

To prevent the battery from becoming dislodged during operation, rotate the latch to the closed position and fold it down as shown at right. Be sure the cover is securely latched.



EN-EL4a Rechargeable Li-ion Batteries

The supplied EN-EL4a shares information with compatible devices, enabling the camera to show battery charge state in six levels (pg. 48). The [Battery info] option in the setup menu details battery charge, battery life, and the number of pictures taken since the battery was last charged (pg. 355). The battery can be recalibrated as necessary to ensure that battery level continues to be reported accurately (pg. 437).

✔ The Battery and Charger

Read and follow the warnings and cautions on pages xviii–xx and 403–406 of this manual. To prevent short-circuits, replace the terminal cover when the battery is not in use.



Do not use the battery at ambient temperatures below 0°C (32°F) or above 40°C (104°F). Charge indoors at ambient temperatures in the vicinity of 5–35°C (41–95°F); for best results, charge the battery at temperatures above 20°C (68°F). Battery capacity may temporarily drop if the battery is charged at low temperatures or used at a temperature below the temperature at which it was charged. If the battery is charged at a temperature below 5°C (41°F), the battery life indicator in the [Battery info] display may show a temporary decrease.

The battery may be hot immediately after use. Wait for the battery to cool before recharging.

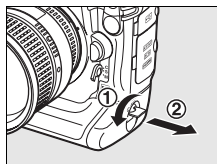
Use the charger with compatible batteries only. Unplug when not in use.

✎ Compatible Batteries

The camera can also be used with EN-EL4 rechargeable Li-ion batteries.

✎ Removing the Battery

Before removing the battery, turn the camera off and lift the battery-chamber cover latch, turn it to the open (⊞) position. To prevent short-circuits, replace the terminal cover when the battery is not in use.

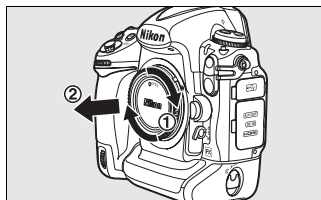
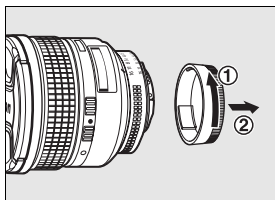


Attach a Lens

Care should be taken to prevent dust from entering the camera when the lens is removed.

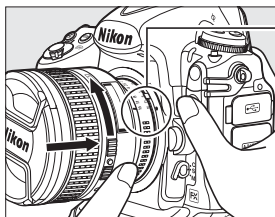
1 Remove the rear lens cap and the camera body cap.

After confirming that the camera is off, remove the rear lens cap from the lens and remove the camera body cap.



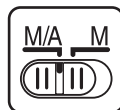
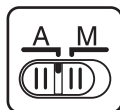
2 Attach the lens.

Keeping the mounting mark on the lens aligned with the mounting mark on the camera body, position the lens in the camera's bayonet mount. Being careful not to press the lens-release button, rotate the lens counter-clockwise until it clicks into place.



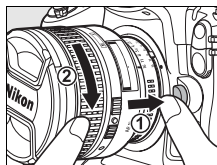
Mounting index

If the lens is equipped with an **A-M** or **M/A-M** switch, select **A** (autofocus) or **M/A** (autofocus with manual priority).



■ Detaching the Lens

Be sure the camera is off when removing or exchanging lenses. To remove the lens, press and hold the lens release button while turning the lens clockwise. After removing the lens, replace the lens caps and camera body cap.

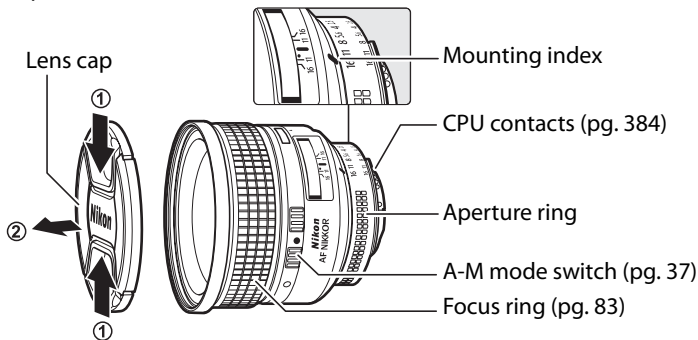


✓ CPU Lenses with Aperture Rings

In the case of CPU lenses equipped with an aperture ring (pg. 384), lock aperture at the minimum setting (highest f-number). See the lens manual for details.

✎ Lens

An AF Nikkor 85 mm f/1.4D lens is used in this manual for illustrative purposes.



✎ Image Area

The DX format image area is automatically selected when a DX lens is attached.



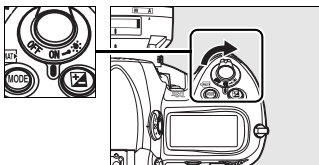
Image area

Basic Setup

The language option in the setup menu is automatically highlighted the first time menus are displayed. Choose a language and set the time and date.

1 Turn the camera on.

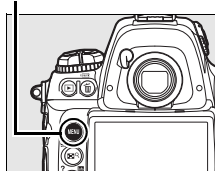
Power switch



2 Select [Language].

Press **MENU** to display the camera menus, then select [Language] in the setup menu. For information on using menus, see “Using Camera Menus” (pg. 28).

MENU button



3 Select a language.

Press **▲** or **▼** to highlight the desired language and press **OK**.



4 Select [World time].

Select [World time] and press



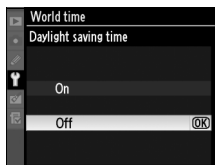
5 Set time zone.

A time-zone selection dialog will be displayed. Press ◀ or ▶ to highlight the local time zone (the [UTC] field shows the difference between the selected time zone and Coordinated Universal Time, or UTC, in hours) and press **OK**.



6 Turn daylight saving time on or off.

Daylight saving time options will be displayed. Daylight saving time is off by default; if daylight saving time is in effect in the local time zone, press ▲ to highlight [On] and press **OK**.



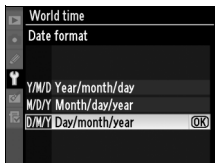
7 Set the date and time.

The dialog shown at right will be displayed. Press ◀ or ▶ to select an item, ▲ or ▼ to change. Press **OK** when the clock is set to the current date and time.



8 Set date format.

Press ▲ or ▼ to choose the order in which the year, month, and day will be displayed and press **OK**.



9 Exit to shooting mode.

Press the shutter-release button halfway to exit to shooting mode.



The **CLOCK** Icon

If a flashing **CLOCK** icon appears in the top control panel the first time the camera is used, check that clock settings (including time zone and daylight saving time) are correct. The icon will stop flashing when the **OK** button is pressed to exit the menu.

The Clock Battery

The camera clock is powered by a separate, non-rechargeable CR1616 lithium battery with a life of about four years. When this battery is exhausted, a **CLOCK** icon will be displayed in the top control panel while the exposure meters are on. For information on replacing the clock battery, see page 398.

The Camera Clock

The camera clock is less accurate than most watches and household clocks. Check the clock regularly against more accurate time pieces and reset as necessary.

Insert a Memory Card

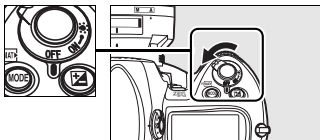
The camera stores photographs on CompactFlash and microdrive memory cards (available separately; pg. 394). Up to two memory cards can be inserted in the camera simultaneously. The following section describes how to insert and format a memory card.



1 Turn the camera off.

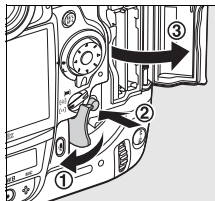
Always turn the camera off before inserting or removing memory cards.

Power switch



2 Open the card slot cover.

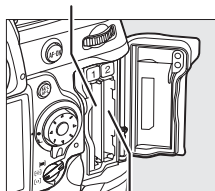
Open the door protecting the card-slot cover release button (1) and press the release button (2) to open the card slot (3).



Memory Card Slots

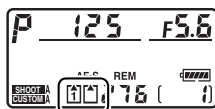
Slot 1 is for the main card; the card in slot 2 plays a backup or secondary role. If the default setting of [Overflow] is selected for [Slot 2] (pg. 72) when two memory cards are inserted, the card in slot 2 will only be used when the card in slot 1 is full.

Slot 1



Slot 2

The card currently in use is indicated in the top control panel.

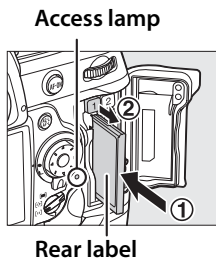


3 Insert the memory card.

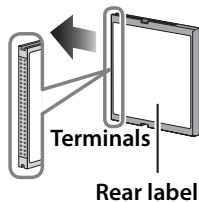
Insert the first memory card in slot 1. Slot 2 should be used only if a card is already inserted in slot 1. Insert the memory card with the rear label toward the monitor (①). When the memory card is fully inserted, the eject button will pop up (②) and the green access lamp will light briefly.

✔ Inserting Memory Cards

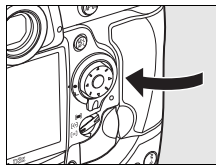
Insert the memory card terminals first. Inserting the card upside down or backwards could damage the camera or the card. Check to be sure that the card is in the correct orientation.



Direction of insertion



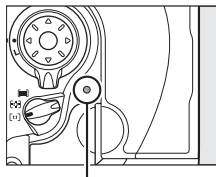
4 Close the card slot cover.



■ Removing Memory Cards

1 Turn the camera off.

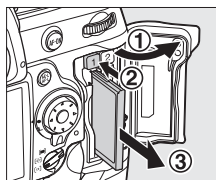
Confirm that the access lamp is off and turn the camera off.



Access lamp

2 Remove the memory card.

Open the memory card slot cover (①) and press the eject button (②) to partially eject the card (③). The memory card can then be removed by hand. Do not push on the memory card while pressing the eject button. Failure to observe this precaution could damage the camera or memory card.



✓ Memory Cards

- Memory cards may be hot after use. Observe due caution when removing memory cards from the camera.
- Memory cards that have been formatted in a computer or other device must be reformatted in the camera before they can be used for recording or playback.
- Turn the power off before inserting or removing memory cards. Do not remove memory cards from the camera, turn the camera off, or remove or disconnect the power source during formatting or while data are being recorded, deleted, or copied to a computer. Failure to observe these precautions could result in loss of data or in damage to the camera or card.
- Do not touch the card terminals with your fingers or metal objects.
- Do not bend, drop, or subject to strong physical shocks.
- Do not apply force to the card casing. Failure to observe this precaution could damage the card.
- Do not expose to water, high levels of humidity, or direct sunlight.

Formatting Memory Cards

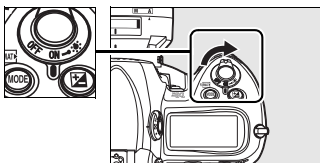
Memory cards must be formatted before first use. Format the card as described below.

✓ Formatting Memory Cards


Formatting memory cards permanently deletes any data they may contain. Be sure to copy any photographs and other data you wish to keep to a computer before proceeding (pg. 256).

1 Turn the camera on.

Power switch

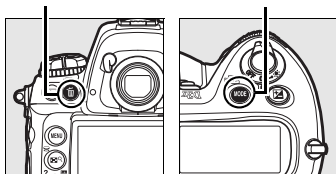



2 Press the **FORMAT** buttons.

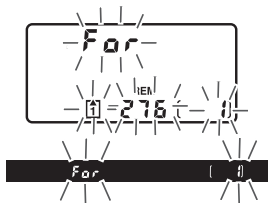
Hold the **FORMAT** (MODE and ) buttons down simultaneously for more than two seconds.

 button



MODE button




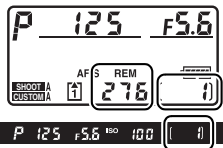
A blinking **For** will appear in the shutter-speed displays in the viewfinder and top control panel. If two memory cards are inserted, the main command dial can be used to select the card to be formatted; check that the correct card is selected in the top control panel before proceeding. To exit without formatting the memory card, press any button other than the **FORMAT** (MODE and ) buttons.





3 Press the buttons again.

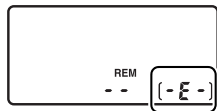
Press the  (MODE and ) buttons together a second time to format the memory card. *Do not remove the memory card or remove or disconnect the power source during formatting.*

When formatting is complete, the top control panel will show the number of photographs that can be recorded at current settings and the frame-count displays will show .



No Memory Card

If no memory card is inserted, the top control panel and viewfinder will show . If the camera is turned off with a charged EN-EL4a battery and no memory card inserted,  will be displayed in the top control panel.



See Also

See page 347 for information on formatting memory cards using the [Format memory card] option in the setup menu.

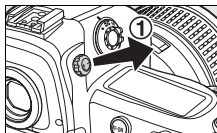


Adjust Viewfinder Focus

The camera is equipped with diopter adjustment to accommodate individual differences in vision. Check that the display in the viewfinder is in focus before shooting.

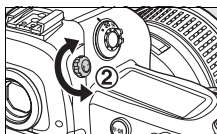
1 Lift the diopter adjustment knob.

Remove the lens cap, turn the camera on, and pull the diopter adjustment knob out (①).



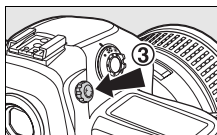
2 Focus the viewfinder.

Rotate the diopter adjustment knob (②) until the viewfinder display, focus points, and AF area brackets are in sharp focus.



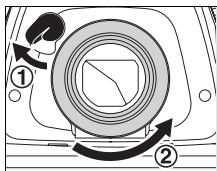
3 Replace the diopter adjustment knob.

Push the diopter adjustment knob back in (③).



Diopter Adjustment Viewfinder Lenses

Corrective lenses (available separately; pg. 389) can be used to further adjust viewfinder diopter. Before attaching a diopter-adjustment viewfinder lens, remove the DK-17 viewfinder eyepiece by closing the viewfinder shutter to release the eyepiece lock (①) and then unscrewing the eyepiece as shown at right (②).



Basic Photography and Playback

Turn the Camera On

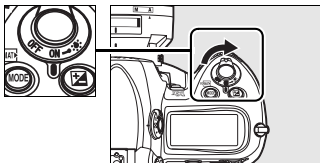
Before taking photographs, turn the camera on and check the battery level and number of exposures remaining as described below.



1 Turn the camera on.

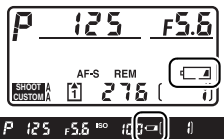
Turn the camera on. The control panels will turn on and the display in the viewfinder will light.

Power switch



2 Check the battery level.



Check the battery level in the viewfinder or top control panel.

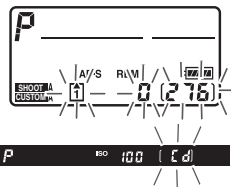
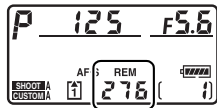


Icon *		Description
Control panel	Viewfinder	
	—	Battery fully charged.
	—	Battery partially discharged.
	—	
	—	
		Low battery. Prepare to charge battery or ready spare battery.
		Shutter release disabled. Charge or exchange battery.

* No icon displayed when camera is powered by optional AC adapter.

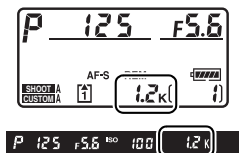
3 Check the number of exposures remaining.

The top control panel shows the number of photographs that can be taken at current settings. When this number reaches zero, the number of exposures remaining, frame count, and  icon will flash in the top control panel and a flashing  icon will appear in the viewfinder. No further pictures can be taken until you delete pictures or insert a new memory card. You may be able to take additional pictures at lower image quality or size settings.



Large-Capacity Memory Cards

When enough memory remains on the memory card to record a thousand or more pictures at current settings, the number of exposures remaining will be shown in thousands, rounded down to the nearest hundred (e.g., if there is room for approximately 1,260 exposures, the exposure count display will show 1.2 K).

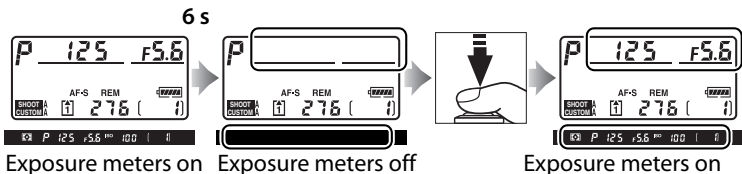


The Battery Indicator

If the segments in the top control panel battery icon blink on and off, the camera is calculating the battery charge. The battery level will be displayed in about three seconds.

Auto Meter Off

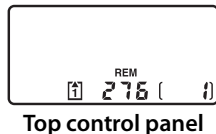
At default settings, the shutter speed and aperture displays in the top control panel and viewfinder will turn off if no operations are performed for about six seconds (auto meter off), reducing the drain on the battery. Press the shutter-release button halfway to reactivate the display in the viewfinder (pg. 56).



The length of time before the exposure meters turn off automatically can be adjusted using Custom Setting c2 ([Auto meter-off delay], pg. 318).

Camera Off Display

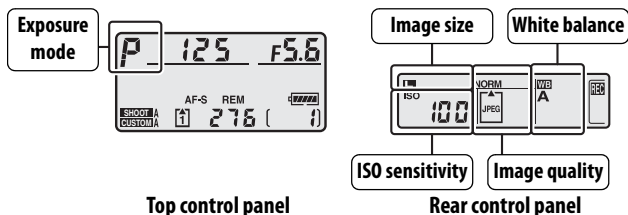
If the camera is turned off with a battery and memory card inserted, the frame count and number of exposures remaining will be displayed (some memory cards may only display this information when the camera is on).



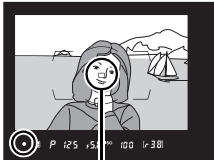
Adjust Camera Settings

This tutorial describes how to take photos at default settings.

1 Check camera settings.

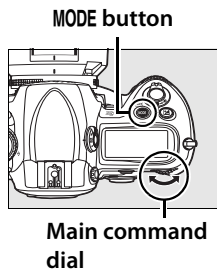


Default settings are listed below.

Option	Default	Description	Page
Image quality	NORM (JPEG normal)	Record JPEG images at a compression ratio of roughly 1 : 8*. Ideal for snapshots. * [Size priority] selected for [JPEG compression].	66
Image size	L (Large)	FX format images are 6,048 × 4,032 pixels in size.	70
ISO sensitivity	100	ISO sensitivity (digital equivalent of film speed) set to ISO 100.	104
White balance	AUTO (Auto)	White balance is adjusted automatically for natural colors under most types of lighting.	140
Exposure mode	P (Programmed auto)	Camera automatically adjusts shutter speed and aperture for optimal exposure in most situations.	112
Focus point	Center focus point (single-point AF)	 <p>Focus point</p> <p>Viewfinder focus point display is shown above. Camera focuses on subject in center focus point when shutter-release button is pressed halfway.</p>	78

2 Choose exposure mode P .

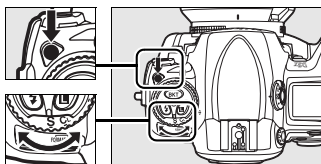
Press the **MODE** button and rotate the main command dial to select exposure mode P . The camera will automatically adjust shutter speed and aperture for optimal exposure in most situations.



3 Choose single frame release mode.

Hold the release mode dial lock release down and turn the release mode dial to **S** (single frame). At this setting, the camera will take one photograph each time the shutter-release button is pressed.

Release mode dial lock release

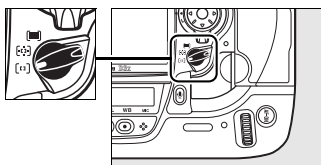


Release mode dial

4 Choose single-point AF.

Rotate the AF-area mode selector until it clicks into place pointing to $[*]$ (single-point AF). At this setting, the user can choose the focus point.

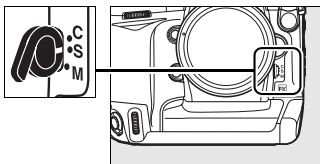
AF-area mode selector




5 Choose single-servo autofocus.

Rotate the focus-mode selector until it clicks into place pointing to **S** (single-servo autofocus). At this setting, the camera will automatically focus on the subject in the selected focus point when the shutter-release button is pressed halfway. Pictures can only be taken when the camera is in focus.

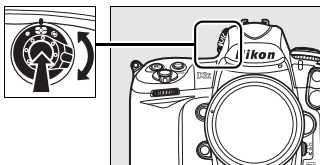
Focus-mode selector



6 Choose matrix metering.

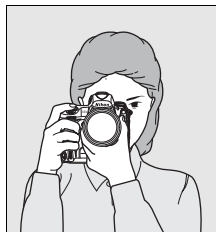
Press the metering selector lock button and rotate the metering selector to  (matrix metering). Matrix metering uses information from the 1,005-segment RGB sensor to ensure optimal results for the entire frame.

Metering selector



Ready the Camera

When framing photographs in the viewfinder, hold the handgrip in your right hand and cradle the camera body or lens with your left. Keep your elbows propped lightly against your torso for support and place one foot half a pace ahead of the other to keep your upper body stable.



When framing photographs in portrait (tall) orientation, unlock the shutter-release button for vertical shooting (pg. 5) and hold the camera as shown at right.



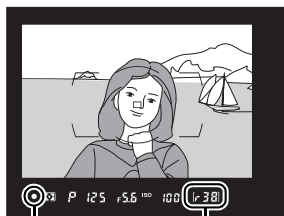
For information on framing photographs in the monitor, see page 90.

Focus and Shoot

- 1 Press the shutter-release button halfway to focus (pg. 56).

At default settings, the camera will focus on the subject in the center focus point. Frame a photo in the viewfinder


with the main subject positioned in the center focus point and press the shutter-release button halfway. If the camera is able to focus, the in-focus indicator (●) will appear in the viewfinder.



Focus indicator

Buffer capacity

Viewfinder display	Description
●	Subject in focus.
▶	Focus point is between camera and subject.
◀	Focus point is behind subject.
▶ ◀ (blinks)	Camera unable to focus on subject in focus point using autofocus.

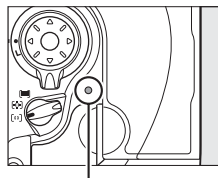
While the shutter-release button is pressed halfway, focus will lock and the number of exposures that can be stored in the memory buffer (“”; pg. 88) will be shown in the viewfinder display.

For information on what to do if the camera is unable to focus using autofocus, see “Getting Good Results with Autofocus” (pg. 82).



2 Press the shutter-release button the rest of the way down to shoot.

Smoothly press the shutter-release-button the rest of the way down to take the picture. While the photograph is being recorded to the memory card, the access lamp next to the card slot cover will light. *Do not eject the memory card, turn the camera off, or remove or disconnect the power source until the lamp has gone out.*



Access lamp

The Shutter-Release Button

The camera has a two-stage shutter-release button. The camera focuses when the shutter-release button is pressed halfway. To take the photograph, press the shutter-release button the rest of the way down.



Focus

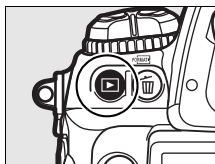


Take
photograph



Viewing Photographs



1 Press the button.

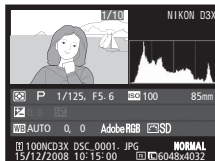
The most recent photograph will be displayed in the monitor.



2 View additional pictures.

Additional pictures can be displayed by pressing  or .

To view additional information on the current photograph, press  and  (pg. 229).



The card containing the current photograph is indicated by an icon as shown at right.




To end playback and return to shooting mode, press the shutter-release button halfway.

Image Review

When [On] is selected for [Image review] in the playback menu (pg. 287), photographs are automatically displayed in the monitor for about 20 s (the default setting) after shooting.

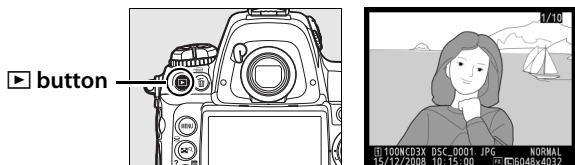
Deleting Unwanted Photographs

To delete the photograph currently displayed in the monitor, press the  button. Note that photographs can not be recovered once deleted.



1 Display the photograph.

Display the photograph you wish to delete as described in “Viewing Photographs” on the previous page.

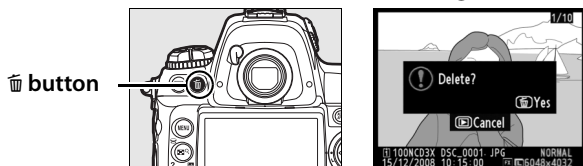




The card containing the current photograph is indicated by an icon as shown at right.



2 Delete the photograph.

Press the  button. A confirmation dialog will be displayed.



Press the  button again to delete the image and return to playback. To exit without deleting the picture, press .

[Delete]

To delete multiple images or to delete images from the second of two memory cards, use the [Delete] option in the playback menu (pg. 281).



Image Recording Options



This section describes how to choose image area, quality, and size and how to choose the role played by memory card slot 2.

Image Area	pg. 60
Image Quality.....	pg. 66
Image Size.....	pg. 70
Slot 2	pg. 72

Image Area

The camera's FX format (35.9 × 24.0 mm) image sensor can be used to record pictures with an image area (picture angle) equivalent to a 35mm (135) format film camera. Image area is selected using the [Image area] option in the shooting menu.



At the default setting of [Auto DX crop], the camera will automatically crop pictures to the DX picture angle when a DX format lens is attached. The [Choose image area] option can be used to select a 35mm picture angle or to crop photographs to the DX format picture angle or to a 5 : 4 aspect ratio.


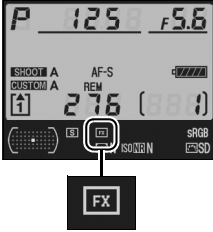

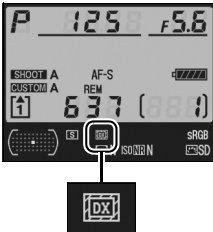

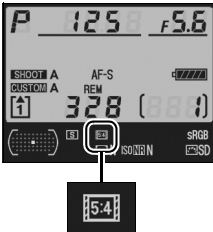
■ ■ Auto DX Crop

Choose whether to automatically select a DX crop when a DX lens is attached.

Option	Description
On (default)	Camera automatically selects DX crop when DX lens is attached.
Off	Crop selected for [Choose image area] is used.

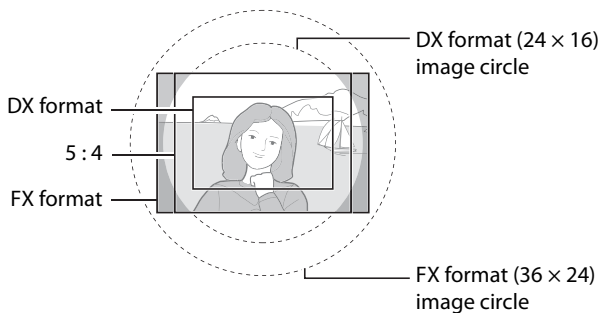
■ Choose Image Area

Choose the image area used when [Off] is selected for [Auto DX crop] (pg. 63).

Option	Description
 FX format (36x24)	<p>Images are recorded in FX format using the full area of the image sensor (35.9 × 24.0 mm), producing a picture angle equivalent to a Nikkor lens on a 35mm format camera. The edges of pictures taken with DX format lenses will be blacked out.</p>  <p>The LCD display shows 'P 125 F5.6', 'SHOOT A AF-S', 'CUSTOM A REM', '276', and 'ISO 1600'. A red box highlights the 'FX' option on the bottom right of the menu, with a line pointing to a larger 'FX' icon below the screen.</p>
 DX format (24x16)	<p>An area at the center of the image sensor 23.6 × 15.7 mm is used to record pictures in DX format. To calculate the approximate focal length of the lens in 35mm format, multiply by 1.5.</p>  <p>The LCD display shows 'P 125 F5.6', 'SHOOT A AF-S', 'CUSTOM A REM', '637', and 'ISO 1600'. A red box highlights the 'DX' option on the bottom right of the menu, with a line pointing to a larger 'DX' icon below the screen.</p>
 5:4 (30x24)	<p>Pictures are recorded with an aspect ratio of 5 : 4 (30.0 × 24.0 mm). The edges of pictures taken with DX format lenses will be blacked out.</p>  <p>The LCD display shows 'P 125 F5.6', 'SHOOT A AF-S', 'CUSTOM A REM', '328', and 'ISO 1600'. A red box highlights the '5:4' option on the bottom right of the menu, with a line pointing to a larger '5:4' icon below the screen.</p>

DX Lenses

DX lenses are designed for use with DX format cameras and have a smaller picture angle than lenses for 35mm format cameras. If [Auto DX crop] is off and [FX format (36 × 24)] or [5 :4 (30 × 24)] is selected for [Image area] when a DX lens is attached, the edges of the image may be eclipsed. This may not be apparent in the viewfinder, but when the images are played back you may notice a drop in resolution or that the edges of the picture are blacked out.



The Viewfinder Display

The DX format and 5 :4 crops are shown below.

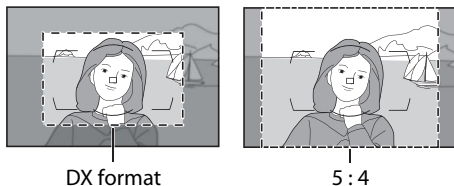


Image area can be set using the [Image area] option in the shooting menu or (at default settings) by pressing the **Fn** button and rotating a command dial.

■ The Image Area Menu

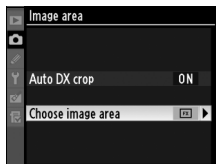
1 Select [Image area].

Highlight [Image area] in the shooting menu (pg. 290) and press **▶**.



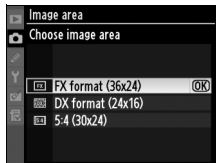
2 Choose an option.

Highlight [Auto DX crop] or [Choose image area] and press **▶**.



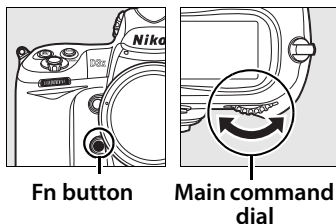
3 Adjust settings.

Choose an option and press **OK**. The selected crop is displayed in the viewfinder (pg. 62).

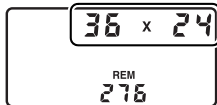


■ The Fn Button

The image area can be selected by pressing the **Fn** button and rotating the main or sub-command dial until the desired crop is displayed in the viewfinder (pg. 62). This operation (the default option for the **Fn** button and command dials; pg. 336) can not be performed while a multiple exposure is being recorded (pg. 209).

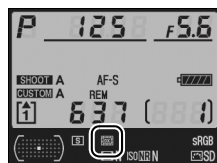


The option currently selected for image area can be viewed by pressing the **Fn** button to display the image area in the top control panel or shooting information display. FX format is displayed as "36 × 24", DX format as "24 × 16", and 5 : 4 as "30 × 24".



✎ Information Display (pg. 14)

The current image area selection can be viewed by pressing the **Info** button to display shooting information in the monitor. **[FX]** is displayed when [FX format (36 × 24)] is selected, **[DX]** when [DX format (24 × 16)] is selected, and **[5:4]** when [5 : 4 (30 × 24)] is selected.



Auto DX Crop

The **Fn** button can not be used to select image area when a DX lens is attached and [Auto DX crop] is on.

The Fn, Depth-of-Field Preview, and AE-L/AF-L Buttons

Changes to image area settings can be made using the **Fn** button (the default setting, see Custom Setting f4, [Assign FUNC. button], pg. 333), the depth-of-field preview button (Custom setting f5, [Assign preview button]), pg. 339), or the **AE-L/AF-L** button (Custom Setting f6, [Assign AE-L/AF-L button], pg. 340). Note that some “button press” options can not be combined with options using “+dials.”


Image Size

Image size varies with the option selected for image area.



Image Quality

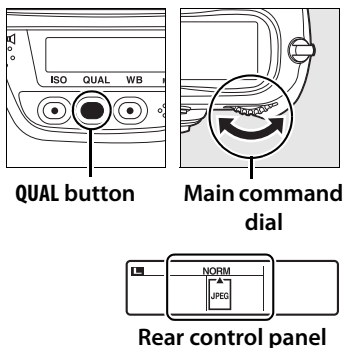
The camera supports the following image quality options.



Option	File type	Description
NEF (RAW)	NEF	Raw data from the image sensor are saved directly to the memory card in Nikon Electronic Format (NEF). Use with images that will be transferred to a computer for printing or processing. Note that once transferred to a computer, NEF (RAW) images can only be viewed using compatible software such as ViewNX (supplied) or Capture NX 2 (available separately; pg. 391).
TIFF (RGB)	TIFF (RGB)	Record uncompressed TIFF-RGB images at a bit depth of 8 bits per channel (24-bit color). TIFF is supported by a wide variety of imaging applications.
JPEG fine	JPEG	Record JPEG images at a compression ratio of roughly 1:4 (fine image quality).*
JPEG normal		Record JPEG images at a compression ratio of roughly 1:8 (normal image quality).*
JPEG basic		Record JPEG images at a compression ratio of roughly 1:16 (basic image quality).*
NEF (RAW)+ JPEG fine	NEF/ JPEG	Two images are recorded, one NEF (RAW) image and one fine-quality JPEG image.
NEF (RAW)+ JPEG normal		Two images are recorded, one NEF (RAW) image and one normal-quality JPEG image.
NEF (RAW)+ JPEG basic		Two images are recorded, one NEF (RAW) image and one basic-quality JPEG image.

* [Size priority] selected for [JPEG compression].

Image quality is set by pressing the **QUAL** button and rotating the main command dial until the desired setting is displayed in the rear control panel.



File Size

See page 427 for information on the number of pictures that can be recorded at different image quality and size settings.

NEF (RAW) Recording

The [NEF (RAW) recording] item in the shooting menu controls compression (pg. 69) and bit depth (pg. 69) for NEF (RAW) images.

JPEG Compression

JPEG images can be compressed for relatively uniform file size or optimal image quality. The [JPEG compression] option in the shooting menu can be used to choose the type of compression (pg. 68).

NEF (RAW)+JPEG

If only one memory card is used, only the JPEG image will be displayed when photographs taken at [NEF (RAW) + JPEG fine], [NEF (RAW) + JPEG normal], or [NEF (RAW) + JPEG basic] are viewed on the camera. Deleting the JPEG image deletes the NEF (RAW) copy. If two memory cards are inserted and [RAW Slot 1-JPEG Slot 2] is selected for Slot 2, deleting the JPEG copy from the memory card in slot 2 has no effect on the NEF (RAW) copy on the memory card in slot 1 (pg. 72).



The Image Quality Menu

Image quality can also be adjusted using the [Image quality] option in the shooting menu (pg. 290).



■ ■ *The JPEG Compression Menu*

The [JPEG compression] item in the shooting menu offers the following options for JPEG images:

Option	Description
 Size priority (default)	Images are compressed to produce relatively uniform file size. Quality varies with scene recorded.
 Optimal quality	Optimal image quality. File size varies with scene recorded.

■■ The NEF (RAW) Recording Menu: Type

The [NEF (RAW) recording] > [Type] item in the shooting menu offers the following compression options for NEF (RAW) images:

Option	Description
Lossless compressed (default)	NEF images are compressed using a reversible algorithm, reducing file size by about 20–40% with no effect on image quality.
Compressed	NEF images are compressed using a non-reversible algorithm, reducing file size by about 40–55% with almost no effect on image quality.
Uncompressed	NEF images are not compressed.

■■ The NEF (RAW) Recording Menu: NEF (RAW) Bit Depth

The [NEF (RAW) recording] > [NEF (RAW) bit depth] item in the shooting menu offers the following bit-depth options for NEF (RAW) images:

Option	Description
12-bit 12-bit (default)	NEF (RAW) images are recorded at a bit-depth of 12 bits.
14-bit 14-bit	NEF (RAW) images are recorded at a bit-depth of 14 bits, producing files larger than 12-bit files but increasing the color data recorded.



Image Size

Image size is measured in pixels. Choose from **Large** (the default option), **Medium**, or **Small** (note that image size varies depending on the option selected for [Image area], pg. 60):

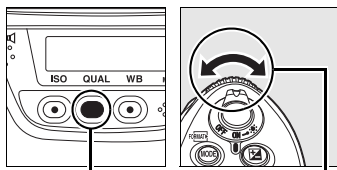
Image area	Option	Size (pixels)	Print size (cm/in.)*
FX format (36 × 24)	L	6,048 × 4,032	76.8 × 51.2/30.2 × 20.2
	M	4,544 × 3,024	57.7 × 38.4/22.7 × 15.1
	S	3,024 × 2,016	38.4 × 25.6/15.1 × 10.1
DX format (24 × 16)	L	3,968 × 2,640	50.4 × 33.5/19.8 × 13.2
	M	2,976 × 1,976	37.8 × 25.1/14.9 × 9.9
	S	1,984 × 1,320	25.2 × 16.8/ 9.9 × 6.6
5 : 4 (30 × 24)	L	5,056 × 4,032	64.2 × 51.2/25.3 × 20.2
	M	3,792 × 3,024	48.2 × 38.4/19.0 × 15.1
	S	2,528 × 2,016	32.1 × 25.6/12.6 × 10.1

* Approximate size when printed at 200 dpi. Print size in inches equals image size in pixels divided by printer resolution in dots per inch (dpi); 1 inch = approximately 2.54 cm). Print size decreases as printer resolution increases.

NEF (RAW) Images

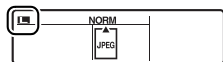
Note that the option selected for image size does not affect the size of NEF (RAW) images. When opened in software such as ViewNX (supplied) or Capture NX 2 (available separately), NEF (RAW) images have the dimensions given for large (L-size) images in the table above.

Image size can be set by pressing the **QUAL** button and rotating the sub-command dial until the desired option is displayed in the rear control panel.



QUAL button

Sub-command dial




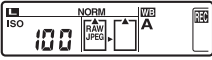

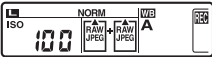

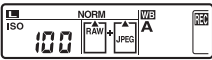
Rear control panel

The Image Size Menu

Image size can also be adjusted using the [Image size] option in the shooting menu (pg. 290).

Slot 2

Use the [Slot 2] option in the shooting menu (pg. 290) to choose the role played by the memory card in slot 2.

Option	Rear control panel	Description
 Overflow (default)		The memory card in slot 2 is used to record photographs when the memory card in slot 1 is full.
 Backup		Each photograph is recorded to both memory cards.
 RAW Slot 1- JPEG Slot 2		At image quality settings of NEF (RAW)+JPEG, the NEF (RAW) image is recorded to the memory card in slot 1, the JPEG image to the memory card in slot 2. At other image qualities, this option is the same as [Backup].

Backup/RAW Slot 1-JPEG Slot 2

When the above options are selected, the shutter-release will be disabled when either of the memory cards is full. The viewfinder and top control panel show the number of exposures remaining on the card with the least amount of available memory. Voice memos (pg. 250) are appended to the copy recorded to the memory card in slot 1.



Focus

– Controlling How the Camera Focuses

This section describes the options that control how your camera focuses.

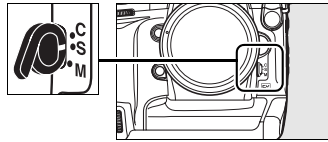


Focus Mode	pg. 74
AF-Area Mode	pg. 76
Focus Point Selection	pg. 78
Focus Lock	pg. 80
Manual Focus	pg. 83

Focus Mode

Focus mode is controlled by the focus-mode selector on the front of the camera. There are two *autofocus* (AF) modes, in which the camera focuses automatically when the shutter-release button is pressed halfway, and one *manual focus* mode, in which focus must be adjusted manually using the focusing ring on the lens:

Focus-mode selector

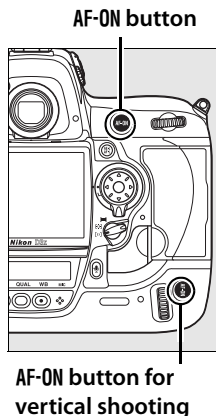


Option	Description
S Single-servo AF	Camera focuses when shutter-release button is pressed halfway. Focus locks when in-focus indicator (●) appears in viewfinder, and remains locked while shutter-release button is pressed halfway (<i>focus lock</i>). At default settings, shutter can only be released when in-focus indicator is displayed (<i>focus priority</i>).
C Continuous- servo AF	Camera focuses continuously while shutter-release button is pressed halfway. If subject moves, camera will engage <i>predictive focus tracking</i> (pg. 75) to predict final distance to subject and adjust focus as necessary. At default settings, shutter can be released whether or not subject is in focus (<i>release priority</i>).
M Manual (pg. 83)	Camera does not focus automatically; focus must be adjusted manually using the lens focusing ring. If maximum aperture of lens is f/5.6 or faster, viewfinder focus indicator can be used to confirm focus (<i>electronic range finding</i> ; pg. 84), but photographs can be taken at any time, whether or not subject is in focus.

Choose single-servo AF for landscapes and other stationary subjects. Continuous-servo AF may be a better choice with erratically-moving subjects. Manual focus is recommended when the camera is unable to focus using autofocus.

The AF-ON Buttons

For the purpose of focusing the camera, pressing either of the **AF-ON** buttons has the same effect as pressing the shutter-release button halfway.



Predictive Focus Tracking

In continuous-servo AF, the camera will initiate predictive focus tracking if the subject moves toward or away from the camera while the shutter-release button is pressed halfway or either of the **AF-ON** buttons is pressed. This allows the camera to track focus while attempting to predict where the subject will be when the shutter is released.

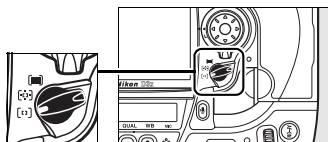
See Also

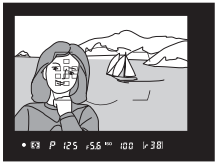
For information on using focus priority in continuous-servo AF, see Custom Setting a1 ([AF-C priority selection], pg. 305). For information on using release priority in single-servo AF, see Custom Setting a2 ([AF-S priority selection], pg. 306). For information on preventing the camera from focusing when the shutter-release button is pressed halfway, see Custom Setting a5 ([AF activation], pg. 309).

AF-Area Mode


AF-area mode determines how the focus point is selected in autofocus mode (pg. 74). To select the AF-area mode, rotate the AF-area mode selector. The following options are available:

AF-area mode selector





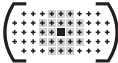
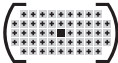
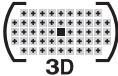

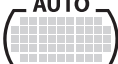
Mode	Description
<p>[□]</p> <p>Single-point AF</p>	<p>User selects focus point manually; camera focuses on subject in selected focus point only. Use for relatively static compositions with subjects that will stay in selected focus point.</p>
<p>[□○]</p> <p>Dynamic-area AF</p>	<ul style="list-style-type: none"> • In continuous-servo AF (pg. 74), user selects focus point manually; if subject briefly leaves selected focus point, camera will focus based on information from surrounding points. Number of focus points used can be selected from 9, 21, and 51 using Custom Setting a3 ([Dynamic AF area], pg. 307). If [51 points (3D-tracking)] is selected for Custom Setting a3, focus point will be selected automatically using 3D-tracking. • In single-servo AF (pg. 74), user selects focus point manually; camera focuses on subject in selected focus point only.
<p>[■]</p> <p>Auto-area AF</p>	<p>Camera automatically detects subject and selects focus point. If type G or D lens is used, camera can distinguish human subjects from background for improved subject detection. In single-servo AF, active focus points are highlighted for about one second after camera focuses. Active focus points are not displayed in continuous-servo AF.</p> 

AF-Area Mode

AF-area mode is shown in the shooting information display when the  button is pressed.



AF-area mode indicator

AF-area mode		Information display
[*] Single-point AF		
[*] Dynamic-area AF*	Custom Setting a3 ([Dynamic AF area], pg. 307)	
	9 points (default)	
	21 points	
	51 points	
	51 points (3D-tracking)	
 Auto-area AF		

* Only active focus point is displayed in the viewfinder. Remaining focus points provide information to assist focus operation.

Manual Focus

Single-point AF is automatically selected when manual focus is used.

See Also

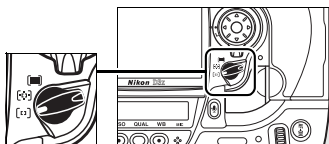
For information on the settings available in dynamic-area AF, see Custom Setting a3 ([Dynamic AF area], pg. 307). For information on adjusting how long the camera waits before refocusing when an object moves in front of the camera, see Custom Setting a4 ([Focus tracking with lock-on], pg. 309).

Focus Point Selection

The camera offers a choice of 51 focus points that together cover a wide area of the frame. The focus point can be selected manually, allowing photographs to be composed with the main subject

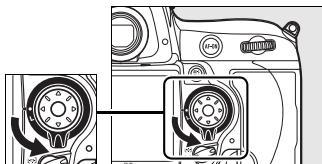
positioned almost anywhere in the frame (single-point and dynamic-area AF), or automatically (auto-area AF; note that manual focus point detection is not available when auto-area AF is selected). To select the focus point manually:

AF-area mode selector



1 Rotate the focus selector lock to ●.

This allows the multi selector to be used to select the focus point.

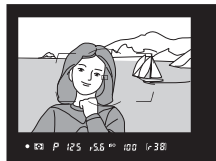
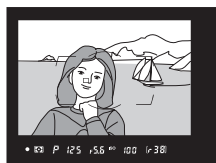


Focus selector lock

2 Select the focus point.

Use the multi selector to select the focus point. At default settings, the center focus point can be selected by pressing the center of the multi selector.

The focus selector lock can be rotated to the locked (L) position following selection to prevent the selected focus point from changing when the multi selector is pressed.



Portrait (Tall-Orientation) Photographs

When framing shots in portrait (“tall”) orientation, use the command dials to select the focus area. For more information, see Custom Setting f4 ([Assign FUNC. button], pg. 337).

See Also

For information on choosing when the focus point is illuminated, see Custom Setting a6 ([Focus point illumination], pg. 310). For information on setting focus-point selection to “wrap around,” see Custom Setting a7 ([Focus point wrap-around], pg. 311). For information on choosing the number of focus points that can be selected using the multi selector, see Custom Setting a8 ([AF point selection], pg. 311). For information on choosing the role of the **AF-ON** button for vertical shooting, see Custom Setting a10 ([Vertical AF-ON button], pg. 313). For information on changing the role of the multi selector center button, see Custom Setting f1 ([Multi selector center button], pg. 331).



Focus Lock

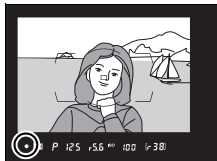
Focus lock can be used to change the composition after focusing, making it possible to focus on a subject that will not be in a focus point in the final composition. It can also be used when the autofocus system is unable to focus (pg. 82).

1 Focus.

Position the subject in the selected focus point and press the shutter-release button halfway to initiate focus.

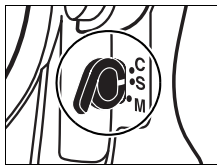


2 Check that the in-focus indicator (●) appears in the viewfinder.



Single-servo AF

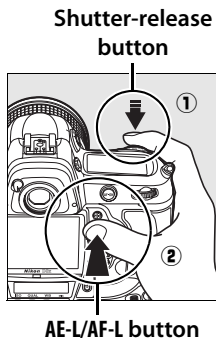
Focus will lock automatically when the in-focus indicator appears, and remain locked until you remove your finger from the shutter-release button.



Focus can also be locked by pressing the **AE-L/AF-L** button (see following page).

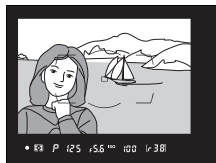
Continuous-servo AF

Press the **AE-L/AF-L** button to lock both focus and exposure (an **AE-L** icon appears in the viewfinder, see page 125). Focus and exposure will remain locked while the **AE-L/AF-L** button is pressed, even if you later remove your finger from the shutter-release button.



3 Recompose the photograph and shoot.

Focus will remain locked between shots as long as the shutter-release button is kept pressed halfway, allowing several photographs in succession to be taken at the same focus setting. Focus will also remain locked between shots while the **AE-L/AF-L** button is pressed.



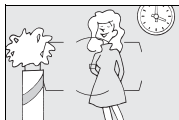
Do not change the distance between the camera and the subject while focus lock is in effect. If the subject moves, focus again at the new distance.

See Also

For information on choosing the role played by the **AE-L/AF-L** button, see Custom Setting f6 ([Assign AE-L/AF-L button], pg. 340).

Getting Good Results with Autofocus

Autofocus does not perform well under the conditions listed below. The shutter release may be disabled if the camera is unable to focus under these conditions, or the in-focus indicator (●) may be displayed, allowing the shutter to be released even when the subject is not in focus. In these cases, use manual focus (pg. 83) or use focus lock (pg. 80) to focus on another subject at the same distance and then recompose the photograph.



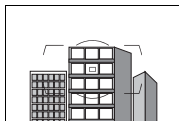
There is little or no contrast between the subject and the background

Example: subject is the same color as the background.



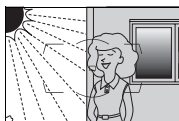
The focus point contains objects at different distances from the camera

Example: subject is inside a cage.



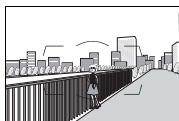
The subject is dominated by regular geometric patterns

Example: a row of windows in a skyscraper.



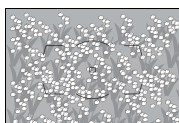
The focus point contains areas of sharply contrasting brightness

Example: subject is half in the shade.



Background objects appear larger than the subject

Example: a building is in the frame behind the subject.



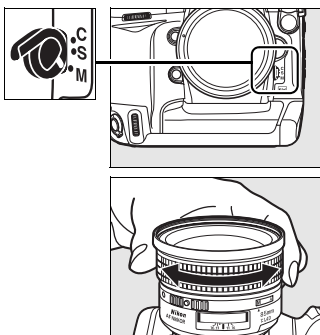
The subject contains many fine details

Example: a field of flowers or other subjects that are small or lack variation in brightness.

Manual Focus

Manual focus is available for lenses that do not support autofocus (non-AF Nikkor lenses) or when the autofocus does not produce the desired results (pg. 82). To focus manually, set the focus-mode selector to **M** and adjust the lens focusing ring until the image displayed on the clear matte field in the viewfinder is in focus. Photographs can be taken at any time, even when the image is not in focus.

Focus-mode selector

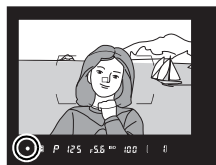


A-M Selection/Autofocus with Manual Priority

If the lens supports A-M selection, set the lens A-M switch to M (manual). If the lens supports M/A (autofocus with manual override, MF priority) or A/M (autofocus with manual override, AF priority), focus can be adjusted manually, regardless of the mode selected with the lens. See the documentation provided with your lens for details.

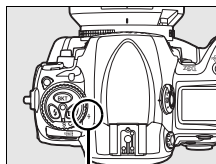
The Electronic Rangefinder

If the lens has a maximum aperture of $f/5.6$ or faster, the viewfinder focus indicator can be used to confirm whether the subject in the selected focus point is in focus (the focus point can be selected from any of the 51 focus points). After positioning the subject in the selected focus point, press the shutter-release button halfway and rotate the lens focusing ring until the in-focus indicator (●) is displayed (pg. 55). Note that with the subjects listed on page 82, the in-focus indicator may sometimes be displayed when the subject is not in focus; confirm focus in the viewfinder before shooting.



Focal Plane Position

To determine the distance between your subject and the camera, measure from the focal plane mark (⊖) on the camera body. The distance between the lens mounting flange and the focal plane is 46.5 mm (1.83 in.).



Focal plane mark



Release Mode

– *Single Frame, Continuous, Live View, Self-Timer, or Mirror Up*



Release mode determines how the camera takes photographs: one at a time, in a continuous sequence, with the view through the lens displayed in the monitor, with a timed shutter-release delay, or with the mirror raised to enhance shutter response and minimize vibration.



Choosing a Release Mode.....	pg. 86
Continuous Mode.....	pg. 88
Framing Pictures in the Monitor (Live View)	pg. 90
Self-Timer Mode	pg. 100
Mirror up Mode.....	pg. 102

Choosing a Release Mode

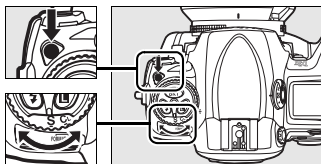
The camera supports the following release modes:

Mode	Description
S Single frame	Camera takes one photograph each time shutter-release button is pressed.
CL Continuous low speed	While shutter-release button is held down, 1–5 frames per second*.
CH Continuous high speed	While shutter-release button is held down, camera records up to 5 frames per second* (5–7 fps when [DX format (24 × 16)] is selected for [Image area]; see page 60).
 Live view	Frame pictures in monitor (pg. 90). Recommended at high or low angles or in other situations in which viewfinder is hard to use or when enlarged view in monitor can assist in obtaining very precise focus.
 Self-timer	Use self-timer for self-portraits or to reduce blurring caused by camera shake (pg. 100).
MUP Mirror up	Choose this mode to minimize camera shake in telephoto or close-up photography or in other situations in which the slightest camera movement can result in blurred photographs (pg. 102).

* Average frame rate with continuous-servo AF, manual or shutter-priority auto exposure, a shutter speed of $1/250$ s or faster, remaining settings other than Custom Setting d2 (pg. 321) at default values, and memory remaining in memory buffer.

To choose a release mode, press the release mode dial lock release and turn the release mode dial to the desired setting.

Release mode dial lock release



Release mode dial

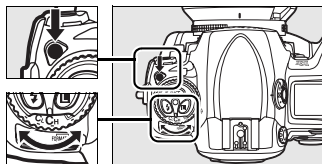


Continuous Mode

To take pictures in **CH** (continuous high speed) and **CL** (continuous low speed) modes:

1 Select CH or CL mode.

Press the release mode dial lock release and turn the release mode dial to **CH** or **CL**.



Release mode dial

2 Frame a photograph, focus, and shoot.

While the shutter-release button is pressed all the way down, pictures will be taken at the frame rate selected for Custom Setting d2 ([Shooting speed], pg. 321).



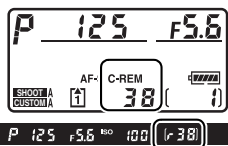
Continuous High Speed

In continuous high speed mode, the maximum frame rate for FX (36 × 24) format and 5 : 4 (30 × 24) images is 5 fps. The maximum frame rate for DX (24 × 16) format images can be chosen from 5, 6, and 7 fps using Custom Setting d2 ([Shooting speed], pg. 321) > [Continuous high-speed].

The maximum frame rate when recording NEF (RAW) images at a bit depth of 14 bits (pg. 69) is 1.8 fps, or 2.6 fps for DX format.

Buffer Size

The approximate number of images that can be stored in the memory buffer at current settings is shown in the exposure-count displays in the viewfinder and top control panel while the shutter-release button is pressed. The illustration at right shows the display when space remains in the buffer for about 38 pictures.



The Memory Buffer

The camera is equipped with a memory buffer for temporary storage, allowing shooting to continue while photographs are being saved to the memory card. Up to 130 photographs can be taken in succession; note, however, that frame rate will drop when the buffer is full. In rare cases, frame rate may also drop when a microdrive memory card is used.

While photographs are being recorded to the memory card, the access lamp next to the memory card slot will light. Depending on the number of the images in the buffer, recording may take from a few seconds to a few minutes. *Do not remove the memory card or remove or disconnect the power source until the access lamp has gone out.* If the camera is switched off while data remain in the buffer, the power will not turn off until all images in the buffer have been recorded. If the battery is exhausted while images remain in the buffer, the shutter release will be disabled and the images transferred to the memory card.

See Also

For information on choosing the maximum number of photographs that can be taken in a single burst, see Custom Setting d3 ([Max. continuous release], pg. 321). For information on the number of pictures that can be taken in a single burst, see page 427.



Framing Pictures in the Monitor (Live View)

Select live view (Lv) mode to frame pictures in the monitor. The following options are available:

- **Hand-held (H)**: Choose when taking hand-held shots of moving subjects, or when framing photographs at angles that make it difficult to use the viewfinder (pg. 91). Camera focuses normally using phase-detection autofocus.
- **Tripod (T)**: Choose when the camera is mounted on a tripod (pg. 94). You can zoom in on the image displayed in the monitor for precise focus, making this option suitable for static subjects. Contrast-detect autofocus can be used to compose photographs with the subject positioned anywhere in the frame.



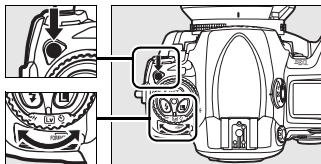
Phase-Detection Versus Contrast-Detect AF

The camera normally uses phase-detection autofocus, in which focus is adjusted based on data from a special focusing sensor. When [Tripod] is selected in live view, however, the camera uses contrast-detect autofocus, in which the camera analyses the data from the image sensor and adjusts focus to produce the greatest contrast. Contrast-detect autofocus takes longer than phase-detection autofocus.

Hand-Held Mode (Lv)

1 Select live view mode.

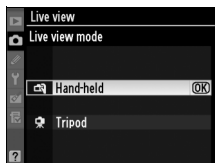
Press the release mode dial lock release and turn the release mode dial to **Lv**.



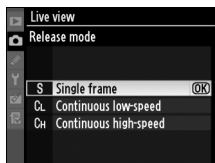
Release mode dial

2 Adjust [Live view] options in the shooting menu.

Select [Live view] in the shooting menu and choose [Hand-held] for [Live view mode].



The [Live view] menu also contains a [Release mode] option, where you can choose from single-frame and continuous release modes (pg. 86).



3 Press the shutter-release button all the way down.


The mirror will be raised and the view through the lens will be displayed in the camera

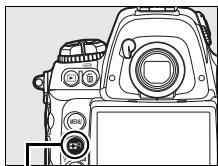


monitor instead of the viewfinder (for improved focus, focus on your subject by pressing the shutter-release button halfway, then press it the rest of the way down to start live view). To exit without taking a picture, rotate the release mode dial to another setting or press **MENU**.

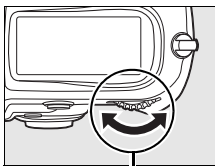


4 Frame a picture in the monitor.

To magnify the view in the monitor up to 13×, press the  button while rotating the main command dial.



 button



Main command dial



While the view through the lens is zoomed in, a navigation window will appear in the bottom right corner of the display. Use the multi selector to scroll within the AF area brackets.

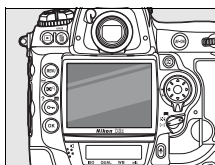


5 Focus.

Autofocus (focus mode **S** or **C**):

Press the shutter-release button halfway or press an **AF-ON** button. The camera will focus normally and set

exposure. Note that the mirror will click back into place while either button is pressed, temporarily interrupting live view. Live view is restored when the button is released.



Manual focus (focus mode **M**; pg. 83): Focus using the lens focusing ring.

6 Take the picture.



Press the shutter-release button the rest of the way down to reset focus and exposure and take the picture. If continuous high speed or continuous low speed is selected for [Release mode], the monitor will turn off while the shutter-release button is pressed.



No Picture

After shooting, play the picture back in the monitor to ensure that the photograph has been recorded. Note that the sound the mirror makes when the shutter-release button is pressed halfway or an **AF-ON** button is pressed can be mistaken for the sound of the shutter, and that pressing the shutter-release button all the way down when the camera is unable to focus in single-servo AF will end live view without a photograph being recorded.

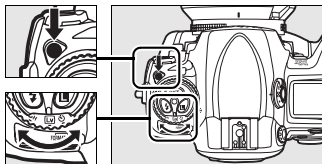
Tripod Mode (三脚架)

1 Ready the camera.

Mount the camera on a tripod or place it on a stable, level surface.

2 Select live view mode.

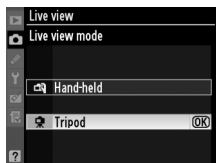
Press the release mode dial lock release and turn the release mode dial to **Lv**.



Release mode dial

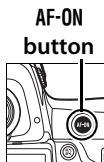
3 Adjust [Live view] options in the shooting menu.

Select [Live view] in the shooting menu and choose [Tripod] for [Live view mode]. [Release mode] options can be selected as described on page 91.



4 Frame a picture in the viewfinder.

Frame a picture in the viewfinder and select a focus point using the multi selector, then press an **AF-ON** button. The camera will focus normally and set exposure. *Note that the camera can NOT be focused by pressing the shutter-release button halfway.*



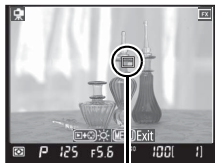
5 Press the shutter-release button all the way down.

The mirror will be raised and the view through the lens will be displayed in the camera monitor. The subject will no longer be visible in the viewfinder. To exit without taking a picture, rotate the release mode dial to another setting or press **MENU**.



6 Focus.

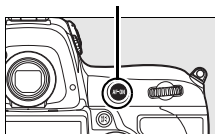
Autofocus (focus mode **S** or **C**): In tripod mode, the focus point for contrast-detect autofocus can be moved to any point in the frame using the multi-selector.



Contrast-detect AF point

To focus using contrast-detect autofocus, press an **AF-ON** button. The focus point will blink green and the monitor may brighten while the camera focuses. If the camera is able to focus using contrast-detect autofocus, the focus point will be displayed in green; if the camera is unable to focus, the focus point will blink red.


AF-ON button

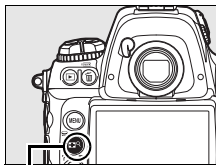


Contrast-Detect Autofocus

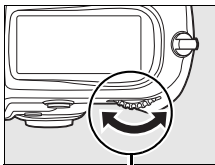
The camera will not continue to adjust focus while an **AF-ON** button is pressed in continuous-servo autofocus mode. In both single-servo and continuous-servo autofocus modes, the shutter can be released even when the camera is not in focus.

Manual focus (focus mode **M**; pg. 83): Use zoom for precise focus.

To magnify the view in the monitor up to 13 × and check focus, press the  button while rotating the main command dial.



 button





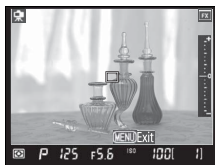
Main command dial



While the view through the lens is zoomed in, a navigation window will appear in the bottom right corner of the display. Use the multi selector to scroll to areas of the frame not visible in the monitor.



To preview exposure at current settings, press . In exposure modes other than *M*, exposure can be adjusted by pressing the  button and rotating the main command dial (note that while exposure compensation can be adjusted by ± 5 EV, only values between -3 and $+3$ EV can be previewed in the monitor).



Exposure Preview

Matrix metering is used to set exposure. Exposure can not be previewed when an optional flash unit is attached, bracketing is in effect (pg. 130), active D-lighting is on (pg. 181), or shutter speed is set to *b*, *z*, *b* or “x 250” (flash sync speed).

Remote Cords

If the shutter-release button on a remote cord (available separately; see pg. 392) is pressed halfway for over a second in tripod mode, it will activate contrast-detect autofocus. If the remote cord shutter-release button is pressed all the way down without focusing, focus will not be adjusted before the picture is taken.

7 Take the picture.

Press the shutter-release button the rest of the way down to take the picture. If continuous high speed or continuous low speed is selected for [Release mode], the monitor will turn off while the shutter-release button is pressed.



Focusing with Contrast-Detect Autofocus

Contrast-detect autofocus will take longer than normal (phase-detection) autofocus. In the following situations, the camera may be unable to focus using contrast-detect autofocus:

- The camera is not mounted on a tripod
- The subject contains lines parallel to the long edges of the frame
- The subject lacks contrast
- The subject in the focus point contains areas of sharply contrasting brightness, or the subject is lit by spot lighting or by a neon sign or other light source that changes in brightness
- A cross (star) filter or other special filter is used
- The subject appears smaller than the focus point
- The subject is dominated by regular geometric patterns (e.g., windows in a skyscraper)
- The subject is moving

Note that the focus point may sometimes be displayed in green when the camera is unable to focus.

Use an AF-S lens. The desired results may not be achieved with other lenses or teleconverters.

✓ Shooting in Live View Mode

Although they will not appear in the final picture, banding or distortion may be visible in the monitor under fluorescent, mercury vapor, or sodium lamps or if the camera is panned horizontally or if an object moves at high speed through the frame. Bright light sources may leave after-images in the monitor when the camera is panned. Bright spots may also appear. When shooting in live view mode, avoid pointing the camera at the sun or other strong light sources. Failure to observe this precaution could result in damage to the camera's internal circuitry.

Live view shooting ends automatically if the lens is removed.

Live view mode can be used for up to an hour.

Note, however, that when used in live view mode

for extended periods, the camera may become noticeably warm and the temperature of its internal circuits may rise, resulting in image noise and unusual colors. To prevent damage to the camera's internal circuits, live view shooting will

end automatically before the camera overheats. A count-down display will appear in the monitor 30 s before shooting ends. At high ambient temperatures, this display may appear immediately when live view mode is selected.




In exposure modes other than manual, close the viewfinder eyepiece shutter after focusing. This prevents light entering via the viewfinder from interfering with exposure (pg. 100).

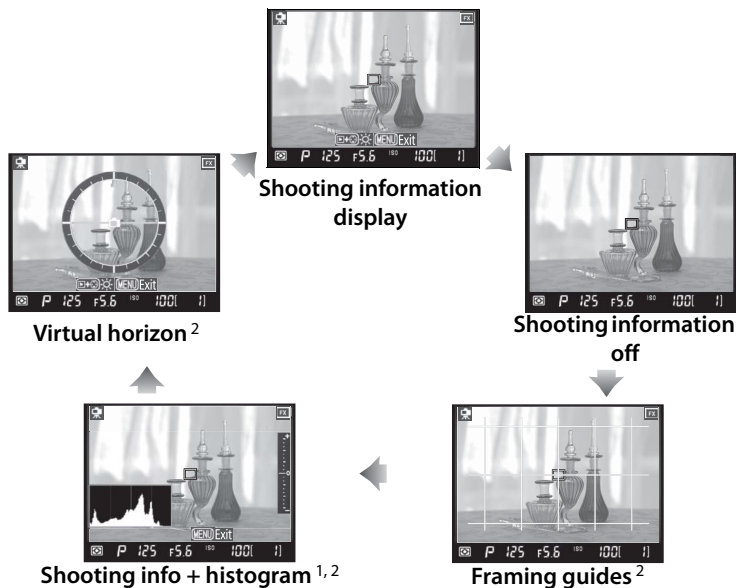
Some noise may be audible when zoom lenses are zoomed in or out or shutter speed is changed in exposure mode **P** or **S**.

To reduce blur in tripod mode, choose [On] for Custom Setting d8 ([Exposure delay mode], pg. 325).

If a CPU lens with an aperture ring is attached and [Aperture ring] selected for Custom Setting f7 ([Customize command dials]) > [Aperture setting] (pp. 341–342), live view will not start and the shutter release will be disabled. Select [Sub-command dial] when using a CPU lens equipped with an aperture ring.





The Shooting Information Display

To hide or display indicators in the monitor in live view mode, press the  button.



- 1 Only displayed during exposure preview (tripod mode; pg. 96).
- 2 Not displayed when view through lens is zoomed in.

Monitor Brightness

Monitor brightness can be adjusted by pressing the  button while the view through the monitor is displayed. Press  or  to adjust brightness (note that monitor brightness has no effect on pictures taken in live view mode). To return to live view, release the  button. Monitor brightness can not be adjusted during exposure preview (pg. 96).

HDMI


When the camera is attached to an HDMI video device, the camera monitor will turn off and the video device will display the view through the lens as shown at right.

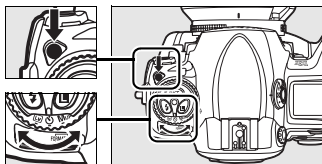


Self-Timer Mode

The self-timer can be used to reduce camera shake or for self-portraits. To use the self-timer, mount the camera on a tripod (recommended) or place the camera on a stable, level surface and follow the steps below:

1 Select self-timer mode.

Press the release mode dial lock release and turn the release mode dial to .

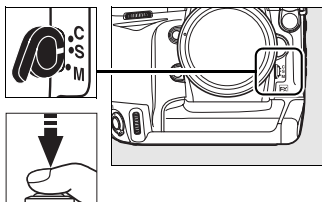


Release mode dial

2 Frame the photograph and focus.

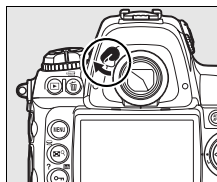
In single-servo autofocus (pg. 74), photographs can only be taken if the in-focus (●) indicator appears in the viewfinder.

Focus-mode selector



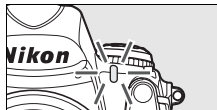
Close the Viewfinder Eyepiece Shutter

In exposure modes other than manual, close the viewfinder eyepiece shutter after focusing. This prevents light entering via the viewfinder from interfering with exposure.



3 Start the timer.

Press the shutter-release button all the way down to start the timer. The self-timer lamp will start to blink, stopping two seconds before the photograph is taken.



To turn the self-timer off before a photograph is taken, turn the release mode dial to another setting.



b u l b

In self-timer mode, a shutter speed of **b u l b** is equivalent to approximately $1/10$ s.

See Also

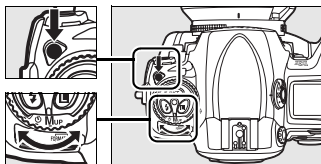
For information on changing the timer duration, see Custom Setting c3 ([Self-timer delay], pg. 319). For information on setting a beep to sound during the timer count-down, see Custom Setting d1 ([Beep], pg. 320).

Mirror up Mode

Choose this mode to minimize blurring caused by camera movement when the mirror is raised. Use of a tripod is recommended.

1 Select mirror up mode.

Press the release mode dial lock release and turn the release mode dial to **MUP**.



Release mode dial

2 Raise the mirror.

Frame the picture, focus, and then press the shutter-release button the rest of the way down to raise the mirror.



Using the Viewfinder

Note that autofocus, metering, and framing can not be confirmed in the viewfinder while mirror is raised.

3 Take a picture.

Press the shutter-release button all the way down again to take a picture. To prevent blurring caused by camera movement, press the shutter-release button smoothly or use an optional remote cord (pg. 392). The mirror lowers when shooting ends.



Mirror up Mode

A picture will be taken automatically if no operations are performed for about 30 s after the mirror is raised.



ISO Sensitivity

– *Reacting Faster to Light*

“ISO sensitivity” is the digital equivalent of film speed. The higher the ISO sensitivity, the less light needed to make an exposure, allowing higher shutter speeds or smaller apertures. This chapter describes how to set ISO sensitivity manually and automatically.

Choosing ISO Sensitivity Manually..... pg. 104

Auto ISO Sensitivity Control..... pg. 106

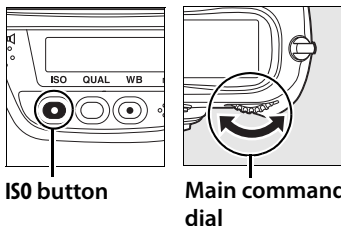
ISO

Choosing ISO Sensitivity Manually

ISO sensitivity can be set to values between ISO 100 and ISO 1600 in steps equivalent to $\frac{1}{3}$ EV. Settings of from about 0.3–1 EV below ISO 100 and 0.3–2 EV above ISO 1600 are also available for special situations.

ISO sensitivity can be adjusted by pressing the **ISO** button and rotating the main command dial until the desired setting is displayed in the control panels or viewfinder.

ISO



Top control panel



Rear control panel



Viewfinder



ISO sensitivity: 1600

The ISO Sensitivity Menu

ISO sensitivity can also be adjusted using the [ISO sensitivity] option in the shooting menu (pg. 290).

ISO Sensitivity Settings

The settings available depend on the option selected for Custom Setting b1 ([ISO sensitivity step value], pg. 314).

Custom Setting b1 (ISO sensitivity step value)	ISO sensitivity settings available
1/3 step (default)	Lo 1, Lo 0.7, Lo 0.3, 100,125,160, 200, 250, 320, 400, 500, 640, 800, 1000, 1250, 1600, Hi 0.3, Hi 0.7, Hi 1, Hi 2
1/2 step	Lo 1, Lo 0.5, 100,140, 200, 280, 400, 560, 800, 1100, 1600, Hi 0.5, Hi 1, Hi 2
1 step	Lo 1, 100, 200, 400, 800, 1600, Hi 1, Hi 2

* If possible, the current ISO sensitivity setting is maintained when the step value is changed. If the current ISO sensitivity setting is not available at the new step value, ISO sensitivity will be rounded up to the nearest available setting.

ISO

Hi 0.3–Hi 2

The settings [Hi 0.3] through [Hi 2] correspond to ISO sensitivities 0.3–2 EV over ISO 1600 (ISO 2000–6400 equivalent). Pictures taken at these settings are more likely to be subject to noise and color distortion.

Lo 0.3–Lo 1

The settings [Lo 0.3] through [Lo 1] correspond to ISO sensitivities 0.3–1 EV below ISO 100 (ISO 80–50 equivalent). Use for larger apertures when lighting is bright. Contrast is slightly lower than normal; in most cases, ISO sensitivities of ISO 100 or above are recommended.

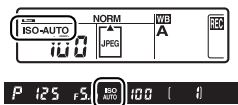
See Also

For information on Custom Setting b1 ([ISO sensitivity step value]), see page 314. For information using the [High ISO NR] option in the shooting menu to reduce noise at high ISO sensitivities, see page 300.

Auto ISO Sensitivity Control

If [Off] (the default setting) is chosen for the [ISO sensitivity auto control] option in the shooting menu, ISO sensitivity will remain fixed at the value selected by the user (see page 104). If [On] is chosen, ISO sensitivity will automatically be adjusted if optimal exposure can not be achieved at the value selected by the user (flash level is adjusted appropriately). The maximum value for auto ISO sensitivity can be selected using the [Maximum sensitivity] option in the [ISO sensitivity auto control] menu (the minimum value for auto ISO sensitivity is automatically set to ISO 100; note that if the value selected for [Maximum sensitivity] is lower than the value currently selected for [ISO sensitivity], the value selected for [Maximum sensitivity] will be used). In exposure modes *P* and *A*, sensitivity will only be adjusted if underexposure would result at the shutter speed selected for [Minimum shutter speed] ($1/4000-1$ s). Slower shutter speeds may be used if optimum exposure can not be achieved at the ISO sensitivity value selected for [Maximum sensitivity].

When [On] is selected, the viewfinder and rear control panel show **ISO-AUTO**. When sensitivity is altered from the value selected by the user, these indicators blink and the altered value is shown in the viewfinder.



Auto ISO Sensitivity Control

Noise is more likely at higher sensitivities. Use the [High ISO NR] option in the shooting menu to reduce noise (see page 300). When a flash is used, the value selected for [Minimum shutter speed] is ignored in favor of the option selected for Custom Setting e1 ([Flash sync speed], pg. 326).

Foreground subjects may be underexposed in photos taken with a flash at slow shutter speeds, in daylight, or against a bright background. Choose a flash mode other than slow sync or select exposure mode **A** or **M** and choose a larger aperture.



Exposure

– *Controlling How the Camera Sets Exposure*



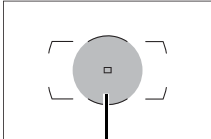

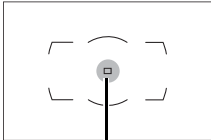
This section describes the options available to control exposure, including metering, exposure mode, exposure lock, exposure compensation, and bracketing.

Metering	pg. 110
Exposure Mode	pg. 112
P: Programmed Auto	pg. 114
S: Shutter-Priority Auto	pg. 116
A: Aperture-Priority Auto	pg. 118
M: Manual	pg. 120
Shutter-Speed and Aperture Lock	pg. 123
Autoexposure (AE) Lock	pg. 125
Exposure Compensation	pg. 128
Bracketing	pg. 130



Metering

Metering determines how the camera sets exposure. The following options are available:

Method	Description	
 3D color matrix II	Recommended in most situations. Camera meters a wide area of the frame and sets exposure according to distribution of brightness, color, distance, and composition for natural results.	
 Center-weighted	Camera meters entire frame but assigns greatest weight to area in center of frame (defaults to 12-mm circle in center of viewfinder; if CPU lens is attached, area can be selected using Custom Setting b5, [Center-weighted area], pg. 316 ¹). Classic meter for portraits. ²	 Center weight area³
 Spot	Camera meters circle 4 mm (0.16 in.) in diameter (approximately 1.5% of frame). Circle is centered on current focus point, making it possible to meter off-center subjects (if non-CPU lens is used or if auto-area AF is in effect (pg. 76), camera will meter center focus point). Ensures that subject will be correctly exposed, even when background is much brighter or darker. ²	 Spot metering area³

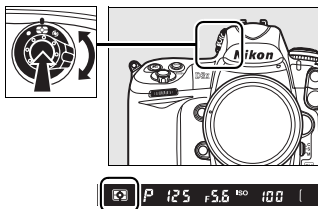
¹ When non-CPU lens is attached, average for entire frame will be used if [Average] is selected for Custom Setting b5; otherwise, center-weighted metering for non-CPU lenses will use 12-mm circle in center of viewfinder, regardless of setting selected for [Non-CPU lens data].

² For improved precision with non-CPU lenses, specify lens focal length and maximum aperture in [Non-CPU lens data] menu (pg. 218).

³ Metered area is not actually displayed in viewfinder.

To choose a metering method, press the metering selector lock button and rotate the metering selector until the desired mode is displayed.

Metering selector



3D Color Matrix II Metering

In matrix metering, exposure is set using a 1005-segment RGB sensor. Use a type G or D lens for results that include range information (3D color matrix metering II; see page 384 for information on lens types). With other CPU lenses, 3D range information is not included (color matrix metering II). Color matrix metering is available when focal length and maximum aperture of non-CPU lens are specified using [Non-CPU lens data] item in setup menu (see page 218; center-weighted metering is used if focal length or aperture is not specified).

See Also

For information on choosing the size of the area assigned the greatest weight in center-weighted metering, see Custom Setting b5 ([Center-weighted area], pg. 316). For information on making separate adjustments to optimal exposure for each metering method, see Custom Setting b6 ([Fine tune optimal exposure], pg. 316).

Exposure Mode

Exposure mode determines how the camera sets shutter speed and aperture when adjusting exposure. Four modes are available: programmed auto (**P**), shutter-priority auto (**S**), aperture-priority auto (**A**), and manual (**M**).

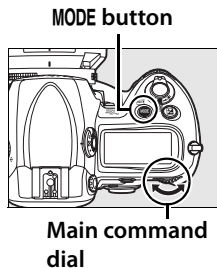
Mode	Description
P Programmed auto (pg. 114)	Camera sets shutter speed and aperture for optimal exposure. Recommended for snapshots and in other situations in which there is little time to adjust camera settings.
S Shutter-priority auto (pg. 116)	User chooses shutter speed; camera selects aperture for best results. Use to freeze or blur motion.
A Aperture-priority auto (pg. 118)	User chooses aperture; camera selects shutter speed for best results. Use to blur background for portraits or bring both foreground and background into focus for landscape shots.
M Manual (pg. 120)	User controls both shutter speed and aperture. Set shutter speed to “ b u l b ” for long time-exposures.

Lens Types

When using a CPU lens equipped with an aperture ring, lock the aperture ring at the minimum aperture (highest f-number). Type G lenses are not equipped with an aperture ring.

Non-CPU lenses can only be used in exposure mode **A** (aperture-priority auto) and **M** (manual). In other modes, exposure mode **A** is automatically selected when a non-CPU lens is attached. The exposure mode indicator (**P** or **S**) in the top control panel will blink and **A** will be displayed in the viewfinder.

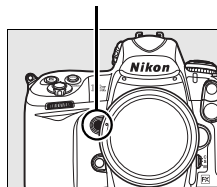
To choose the exposure mode, press the **MODE** button and rotate the main command dial until the desired mode is displayed in the viewfinder or top control panel.



Depth-of-Field Preview

To preview the effects of aperture, press and hold the depth-of-field preview button. The lens will be stopped down to the aperture value selected by the camera (modes *P* and *S*) or the value chosen by the user (modes *A* and *M*), allowing depth of field to be previewed in the viewfinder.

Preview button



Custom Setting e3—Modeling Flash

This setting controls whether the SB-900, SB-800, SB-600, SB-R200, and other optional flash units that support the Creative Lighting System (CLS; see page 186) will emit a modeling flash when the depth-of-field preview button is pressed. See page 327 for more information.

See Also

See page 106 for information on auto ISO sensitivity control. For information on using the [Long exp. NR] option in the shooting menu for reducing noise at slow shutter speeds, see page 300. For information on choosing the size of the increments available for shutter speed and aperture, see Custom Setting b2 ([EV steps for exposure cntrl.], pg. 314). For information on changing the roles of the main and sub-command dials, see Custom Setting f7 ([Customize command dials] > [Change main/sub], pg. 341).

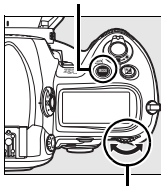
P: Programmed Auto

In this mode, the camera automatically adjusts shutter speed and aperture according to a built-in program to ensure optimal exposure in most situations. This mode is recommended for snapshots and other situations in which you want to leave the camera in charge of shutter speed and aperture. To take photographs in programmed auto:

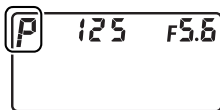
1 Select exposure mode P.

Press the **MODE** button and rotate the main command dial until **P** is displayed in the viewfinder and top control panel.

MODE button



Main command dial



2 Frame a photograph, focus, and shoot.

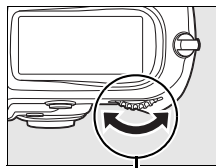


Shutter speed: $\frac{1}{320}$ s

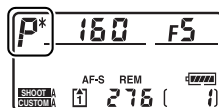
Aperture: f/9

Flexible Program

In exposure mode **P**, different combinations of shutter speed and aperture can be selected by rotating the main command dial (“flexible program”). Rotate the command dial to the right for large apertures (small f-numbers) that blur background details or fast shutter speeds that “freeze” motion. Rotate the command dial to the left for small apertures (large f-numbers) that increase depth of field or slow shutter speeds that blur motion. All combinations produce the same exposure. While flexible program is in effect, an asterisk (“*”) appears in the top control panel. To restore default shutter speed and aperture settings, rotate the command dial until the asterisk is no longer displayed, choose another mode, or turn the camera off.



Main command dial



Shutter speed: $\frac{1}{2,000}$ s
Aperture: f/3.5



Shutter speed: $\frac{1}{50}$ s
Aperture: f/22

See Also

See page 430 for information on the built-in exposure program.

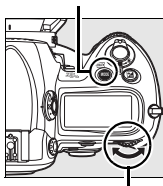
5: Shutter-Priority Auto

In shutter-priority auto, you choose the shutter speed while the camera automatically selects the aperture that will produce the optimal exposure. To take photographs in shutter-priority auto:

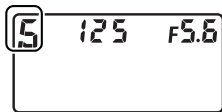
1 Select exposure mode 5.

Press the **MODE** button and rotate the main command dial until **5** is displayed in the viewfinder and top control panel.

MODE button



Main command dial



2 Choose a shutter speed.

Rotate the main command dial to choose the desired shutter speed. Shutter speed can be set to “x 250” (the flash sync speed limit) or to values between 30 s (30'') and $1/8,000$ s (8000). Use slow shutter speeds to suggest motion by blurring moving objects, high shutter speeds to “freeze” motion.





Fast shutter speed ($1/1,000$ s)



Slow shutter speed ($1/10$ s)

Shutter speed can be locked at the selected setting (see page 123).

3 Frame a photograph, focus, and shoot.



See Also

See page 416 for information on what to do if flashing “**b L b**” indicator appears in the shutter-speed displays.

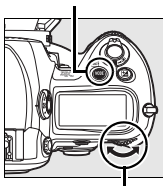
A: Aperture-Priority Auto

In aperture-priority auto, you choose the aperture while the camera automatically selects the shutter speed that will produce the optimal exposure. To take photographs in aperture-priority auto:

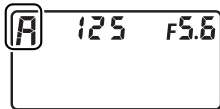
1 Select exposure mode A.

Press the **MODE** button and rotate the main command dial until **A** is displayed in the viewfinder and top control panel.

MODE button

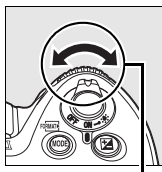


Main command dial

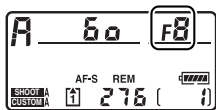


2 Choose an aperture.

Rotate the sub-command dial to choose the desired aperture from values between the minimum and maximum for the lens.



Sub-command dial



Small apertures (high f-numbers) increase depth of field (see page 113), bringing both foreground and background into focus. Large apertures (low f-numbers) soften background details in portraits or other compositions that emphasize the main subject.



Small aperture (f/36)



Large aperture (f/2.8)

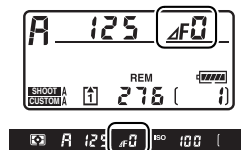
Aperture can be locked at the selected setting (see page 124).

3 Frame a photograph, focus, and shoot.



Non-CPU Lenses

If the maximum aperture of the lens has been specified using the [Non-CPU lens data] item in setup menu (pg. 218) when a non-CPU lens is attached, the current f-number will be displayed in the viewfinder and top control panel, rounded to the nearest full stop. Otherwise the aperture displays will show only the number of stops (ΔF , with maximum aperture displayed as $\Delta F0$) and the f-number must be read from the lens aperture ring.



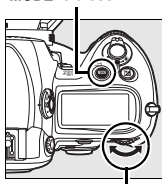
M: Manual

In manual exposure mode, you control both shutter speed and aperture. To take photographs in manual exposure mode:

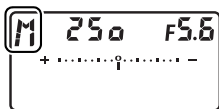
1 Select exposure mode M.

Press the **MODE** button and rotate the main command dial until **M** is displayed in the viewfinder and top control panel.

MODE button

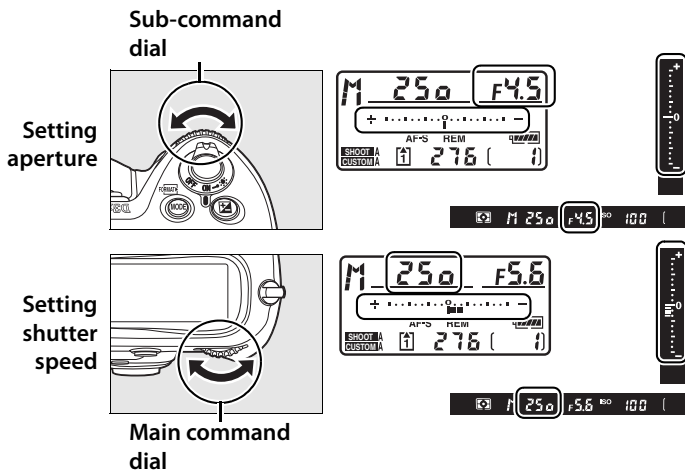


Main command dial



2 Choose aperture and shutter speed.

Rotate the main command dial to choose a shutter speed, and the sub-command dial to set aperture. Shutter speed can be set to “x 250” (the flash sync speed limit) or to values between 30 s and $\frac{1}{8,000}$ s, or the shutter can be held open indefinitely for a long time-exposure (**b u l b**, pg. 122). Aperture can be set to values between the minimum and maximum values for the lens. Check exposure in the electronic analog exposure displays (see page 122), and continue to adjust shutter speed and aperture until the desired exposure is achieved.



Shutter speed and aperture can be locked at the selected setting (see pages 123, 124).

3 Frame a photograph, focus, and shoot.









Shutter speed: $\frac{1}{250}$ s
Aperture: f/8

AF Micro Nikkor Lenses

Provided that an external exposure meter is used, the exposure ratio need only be taken into account when the lens aperture ring is used to set aperture.

Electronic Analog Exposure Displays

The electronic analog exposure displays in the viewfinder and top control panel show whether the photograph would be under- or over-exposed at current settings. Depending on the option chosen for Custom Setting b2 ([EV steps for exposure cntrl.], pg. 314), the amount of under- or over-exposure is shown in increments of $\frac{1}{3}$ EV, $\frac{1}{2}$ EV, or 1 EV. If the limits of the exposure metering system are exceeded, the displays will flash.

		Custom Setting b2 set to [1/3 step]		
		Optimal exposure	Underexposed by $\frac{1}{3}$ EV	Overexposed by over 3 EV
Control panel				
Viewfinder				

Long Time-Exposures

At a shutter speed of **35**, the shutter will remain open while the shutter-release button is held down. Use for long time-exposure photographs of moving lights, the stars, night scenery, or fireworks. Nikon recommends using a fully-charged EN-EL4a battery or an optional EH-6 AC adapter to prevent loss of power while the shutter is open. Note that noise and distortion may be present in long exposures; before shooting, choose [On] for the [Long exp. NR] option in the shooting menu (pg. 300).



Shutter speed: 35 s
Aperture: f/25

See Also

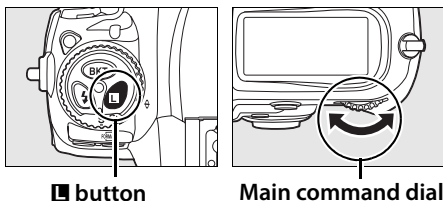
See Custom Setting f10 ([Reverse indicators], pg. 345) for information on reversing the electronic analog exposure display.

Shutter-Speed and Aperture Lock

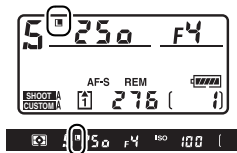
The **L** button can be used to lock shutter speed at the value selected in shutter-priority auto or manual exposure mode, or to lock aperture at the value selected in aperture-priority auto and manual exposure modes. Lock is not available in programmed auto.

■ ■ Shutter-Speed Lock

To lock shutter speed at the selected value, press the **L** button and rotate the main command dial until **L** icons appear in the viewfinder and the top control panel.

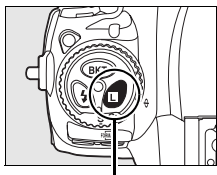


To unlock shutter speed, press the **L** button and rotate the main command dial until the **L** icons disappear from the displays.

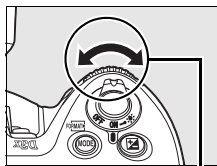


Aperture Lock

To lock aperture at the selected value, press the **L** button and rotate the sub-command dial until **L** icons appear in the viewfinder and the top control panel.

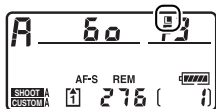


L button



Sub-command dial

To unlock aperture, press the **L** button and rotate the sub-command dial until the **L** icons disappear from the displays.



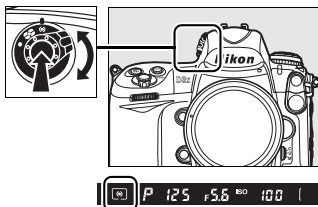
Autoexposure (AE) Lock

Use autoexposure lock to recompose photographs after metering exposure.

1 Select center-weighted or spot metering (pg. 110).

Matrix metering will not produce the desired results with autoexposure lock. If using center-weighted metering, select the center focus point with the multi selector (pg. 78).

Metering selector

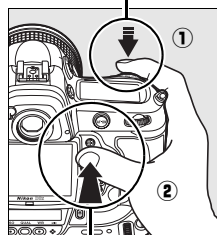


2 Lock exposure.

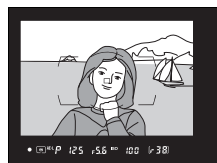
Position the subject in the selected focus point and press the shutter-release button halfway. With the shutter-release button pressed halfway and the subject positioned in the focus point, press the **AE-L/AF-L** button to lock exposure (and focus, except in manual focus mode). Confirm that the in-focus indicator (●) appears in the viewfinder.

While exposure lock is in effect, an **AE-L** indicator will appear in the viewfinder.

Shutter-release button

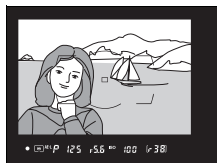


AE-L/AF-L button



3 Recompose the photograph.

Keeping the **AE-L/AF-L** button pressed, recompose the photograph and shoot.



Metered Area

In spot metering, exposure will be locked at the value metered in a 4-mm (0.16 in.) circle centered on the selected focus point. In center-weighted metering, exposure will be locked at the value metered in the center of the viewfinder (the default area for center-weighted metering is shown by the 12-mm circle in the viewfinder).

Adjusting Shutter Speed and Aperture

While exposure lock is in effect, the following settings can be changed without altering the metered value for exposure:

Exposure mode	Settings
<i>P</i>	Shutter speed and aperture (flexible program; pg. 115)
<i>S</i>	Shutter speed
<i>A</i>	Aperture

The new values can be confirmed in the viewfinder and top control panel. Note that the metering method can not be changed while exposure lock is in effect (changes to metering take effect when the lock is released).

See Also


If [On] is selected for Custom Setting c1 ([Shutter-release button AE-L], pg. 318), exposure will lock when the shutter-release button is pressed halfway. For information on changing the role of the **AE-L/AF-L** button, see Custom Setting f6 ([Assign AE-L/AF-L button], pg. 340).

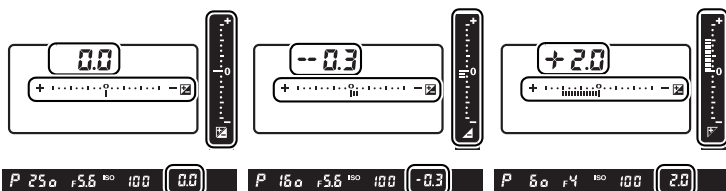
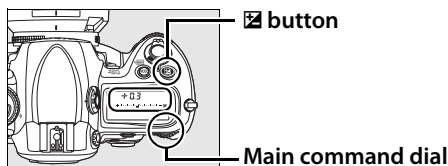


Exposure Compensation

Exposure compensation is used to alter exposure from the value suggested by the camera, making pictures brighter or darker.

In exposure mode *M*, only the exposure information shown in the electronic analog exposure display is affected; shutter speed and aperture do not change.


To choose a value for exposure compensation, press the  button and rotate the main command dial until the desired value is displayed in the viewfinder or top control panel.



±0 EV

-0.3 EV

+2.0 EV

( button pressed)

Exposure compensation can be set to values between -5 EV (underexposure) and $+5$ EV (overexposure) in increments of $1/3$ EV. In general, choose positive values to make the subject brighter, negative values to make it darker.






-1 EV



**No exposure
compensation**




+1 EV

At values other than ± 0 , the 0 at the center of the electronic analog exposure displays will flash and a  icon will be displayed in the viewfinder and top control panel after you release the  button. The current value for exposure compensation can be confirmed in the electronic analog exposure display by pressing the  button.

Normal exposure can be restored by setting exposure compensation to ± 0 . Exposure compensation is not reset when the camera is turned off.

See Also

For information on choosing the size of the increments available for exposure compensation, see Custom Setting b3 ([EV steps for exposure comp.], pg. 314). For information on making adjustments to exposure compensation without pressing the  button, see Custom Setting b4 ([Easy exposure compensation], pg. 315).

Bracketing

The camera offers three types of bracketing: exposure bracketing, flash bracketing, and white balance bracketing. In *exposure bracketing* (pg. 131), the camera varies exposure compensation with each shot, while in the case of *flash bracketing* (pg. 131), flash level is varied with each shot (i-TTL and, in the case of the SB-900 and SB-800, auto aperture flash control modes only; see pages 186 and 189). Only one photograph is produced each time the shutter is released, meaning that several shots are required to complete the bracketing sequence. Exposure and flash bracketing are recommended in situations in which it is difficult to set exposure and there is not enough time to check results and adjust settings with each shot.



In *white balance bracketing* (pg. 135), the camera creates multiple images each time the shutter is released, each with a different white balance adjustment. Only one shot is required to complete the bracketing sequence. White balance bracketing is recommended when shooting under mixed lighting or experimenting with different white balance settings.

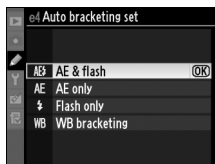
See Also

At default settings, the camera varies both exposure and flash level. Custom Setting e4 ([Auto bracketing set], pg. 328) is used to choose the type of bracketing performed.

■ Exposure and Flash Bracketing

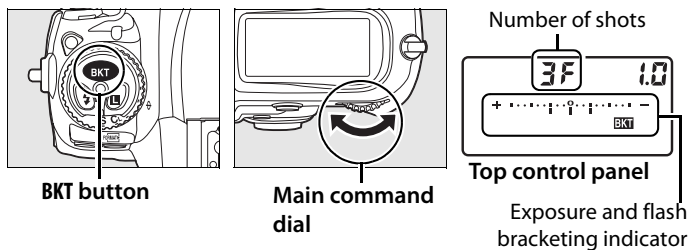
1 Select flash or exposure bracketing.

Choose the type of bracketing to be performed using Custom Setting e4 ([Auto bracketing set], pg. 328). Choose [AE & flash] to vary both exposure and flash level (the default setting), [AE only] to vary only exposure, or [Flash only] to vary only flash level.



2 Choose the number of shots.

Pressing the **BKT** button, rotate the main command dial to choose the number of shots in the bracketing sequence. The number of shots is shown in the top control panel.

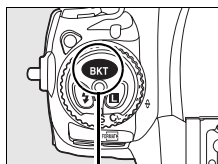


At settings other than zero, a **BKT** icon and exposure and flash bracketing indicator will be displayed in the viewfinder and top control panel.

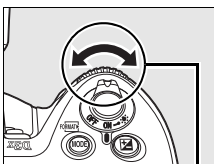


3 Select an exposure increment.

Pressing the **BKT** button, rotate the sub-command dial to choose the exposure increment.

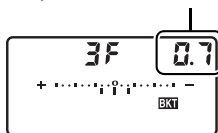


BKT button



Sub-command dial

Exposure increment



Top control panel dial

At default settings, the size of the increment can be chosen from $\frac{1}{3}$, $\frac{2}{3}$, and 1 EV. The bracketing programs with an increment of $\frac{1}{3}$ EV are listed below.

Control panel display	No. of shots	Bracketing order (EVs)
0F 0.3 + 0 -	0	0
+ 3F 0.3 + iii -	3	+0.3/0/+0.7
-- 3F 0.3 + iiii -	3	-0.3/-0.7/0
+ 2F 0.3 + ii -	2	0/+0.3
-- 2F 0.3 + i -	2	0/-0.3
3F 0.3 + iii -	3	0/-0.3/+0.3
5F 0.3 + iiiii -	5	0/-0.7/-0.3/+0.3/+0.7
7F 0.3 + iiiiii -	7	0/-1.0/-0.7/-0.3/+0.3/ +0.7/+1.0
9F 0.3 + iiiiii -	9	0/-1.3/-1.0/-0.7/-0.3/ +0.3/+0.7/+1.0/+1.3

See Also

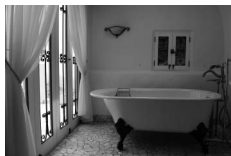
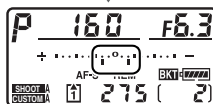
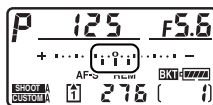
For information on choosing the size of the exposure increment, see Custom Setting b2 ([EV steps for exposure cntrl.], pg. 314). For information on choosing the order in which bracketing is performed, see Custom Setting e6 ([Bracketing order], pg. 330).

4 Frame a photograph, focus, and shoot.

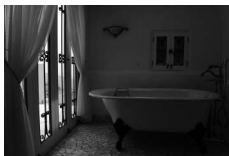


The camera will vary exposure and/or flash level shot-by-shot according to the bracketing program selected. Modifications to exposure are added to those made with exposure compensation (see page 128), making it possible to achieve exposure compensation values of more than 5 EV.

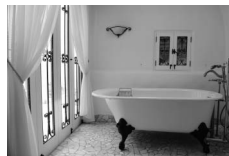
While bracketing is in effect, a bracketing progress indicator will be displayed in the top control panel and viewfinder. A segment will disappear from the indicator after each shot.



Exposure increment:
0 EV



Exposure increment:
-1 EV



Exposure increment:
+1 EV



■ ■ **Canceling Bracketing**

To cancel bracketing, press the **BKT** button and rotate the main command dial until the number of shots in the bracketing sequence is zero (0) and **BKT** is no longer displayed in the control panel on top of the camera. The program last in effect will be restored the next time bracketing is activated. Bracketing can also be cancelled by performing a two-button reset (pg. 204), although in this case the bracketing program will not be restored the next time bracketing is activated.

Exposure and Flash Bracketing

In single frame and self-timer modes, one shot will be taken each time the shutter-release button is pressed. In continuous low speed and continuous high speed modes, shooting will pause after the number of shots specified in the bracketing program have been taken. Shooting will resume the next time the shutter-release button is pressed.

If the memory card fills before all shots in the sequence have been taken, shooting can be resumed from the next shot in the sequence after the memory card has been replaced or shots have been deleted to make room on the memory card. If the camera is turned off before all shots in the sequence have been taken, bracketing will resume from the next shot in the sequence when the camera is turned on.

Exposure Bracketing

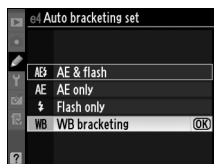
The camera modifies exposure by varying shutter speed and aperture (programmed auto), aperture (shutter-priority auto), or shutter speed (aperture-priority auto, manual exposure mode). When [On] is selected for [ISO sensitivity settings] > [ISO sensitivity auto control] in shooting menu and no flash is attached, the camera will automatically vary ISO sensitivity for optimum exposure when the limits of the camera exposure system are exceeded.

Custom Setting e5 ([Auto bracketing (mode M)], pg. 329) can be used to change how the camera performs exposure and flash bracketing in manual exposure mode. Bracketing can be performed by varying flash level together with shutter speed and/or aperture, or by varying flash level alone.

■ White Balance Bracketing

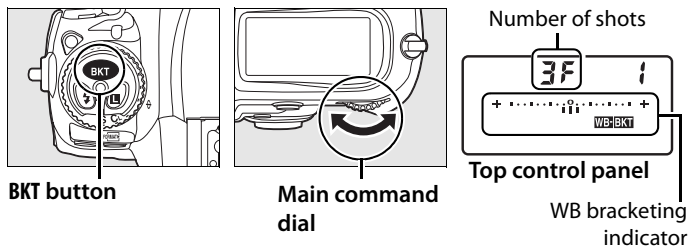
1 Select white balance bracketing.

Choose [WB bracketing] for Custom Setting e4 [Auto bracketing set] (pg. 328).

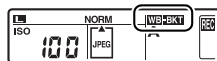


2 Choose the number of shots.

Pressing the **BKT** button, rotate the main command dial to choose the number of shots in the bracketing sequence. The number of shots is shown in the top control panel.

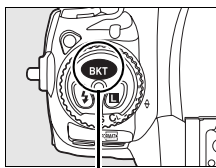


At settings other than zero, a WB bracketing indicator will appear in the top control panel and a **WB-BKT** icon will be displayed in the top and rear control panels.

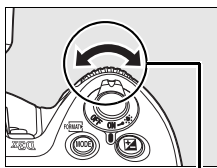


3 Select a white balance increment.

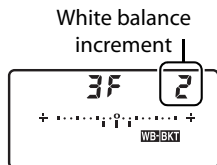
Pressing the **BKT** button, rotate the sub-command dial to choose the white balance adjustment. Each increment is roughly equivalent to 5 mired.



BKT button



Sub-command dial



Top control panel

Choose from increments of 1 (5 mired), 2 (10 mired), or 3 (15 mired). Higher **B** values correspond to increased amounts of blue, higher **A** values to increased amounts of amber (pg. 144). The bracketing programs with an increment of 1 are listed below.

Control panel display	No. of shots	White balance increment	Bracketing order (EVs)
0F 1 +.....+*	0	1	0
3F 1 +.....+*	3	1 B	1 B / 0 / 2 B
A3F 1 +.....+*	3	1 A	1 A / 2 A / 0
b2F 1 +.....+*	2	1 B	0 / 1 B
A2F 1 +.....+*	2	1 A	0 / 1 A
3F 1 +.....+*	3	1 A, 1 B	0 / 1 A / 1 B
5F 1 +.....+*	5	1 A, 1 B	0 / 2 A / 1 A / 1 B / 2 B
7F 1 +.....+*	7	1 A, 1 B	0 / 3 A / 2 A / 1 A / 1 B / 2 B / 3 B
9F 1 +.....+*	9	1 A, 1 B	0 / 4 A / 3 A / 2 A / 1 A / 1 B / 2 B / 3 B / 4 B



See Also

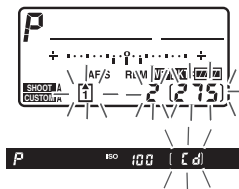
See page 145 for a definition of “mired.”

4 Frame a photograph, focus, and shoot.



Each shot will be processed to create the number of copies specified in the bracketing program, and each copy will have a different white balance. Modifications to white balance are added to the white balance adjustment made with white balance fine-tuning.

If the number of shots in the bracketing program is greater than the number of exposures remaining, the number of exposures remaining, frame count, and  icon will flash in the top control panel, a flashing  icon will appear in the viewfinder, and the shutter release will be disabled. Shooting can begin when a new memory card is inserted.



■ ■ **Canceling Bracketing**

To cancel bracketing, press the **BKT** button and rotate the main command dial until the number of shots in the bracketing sequence is zero (0 F) and **WB: BKT** are no longer displayed in the control panels. The program last in effect will be restored the next time bracketing is activated. Bracketing can also be cancelled by performing a two-button reset (pg. 204), although in this case the bracketing program will not be restored the next time bracketing is activated.



White Balance Bracketing

White balance bracketing is not available at an image quality of NEF (RAW). Selecting [NEF (RAW)], [NEF (RAW)+JPEG fine], [NEF (RAW)+JPEG normal], or [NEF (RAW)+JPEG basic] cancels white balance bracketing.

White balance bracketing affects only color temperature (the amber-blue axis in the white balance fine-tuning display, pg. 144). No adjustments are made on the green-magenta axis.

In self-timer mode (pg. 100), the number of copies specified in the white-balance program will be created each time the shutter is released.

If the camera is turned off while the memory card access lamp is lit, the camera will power off only after all photographs in the sequence have been recorded.



White Balance

– *Keeping Colors True*




The color of light reflected from an object varies with the color of the light source. The human brain is able to adapt to changes in the color of the light source, with the result that white objects appear white whether seen in the shade, direct sunlight, or under incandescent lighting. Unlike the film used in film cameras, digital cameras can mimic this adjustment by processing images according to the color of the light source. This is known as “white balance.” This chapter covers white balance settings.





White Balance Options.....	pg. 140
Fine-Tuning White Balance.....	pg. 143
Choosing a Color Temperature.....	pg. 147
Preset Manual	pg. 148



White Balance Options

For natural coloration, choose a white balance setting that matches the light source before shooting. The following options are available:

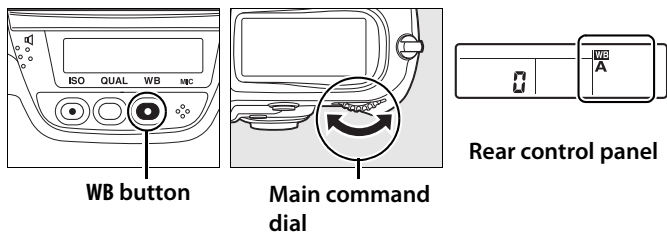
Option	Color temp. (K)	Description
AUTO Auto (default)	3,500–8,000*	White balance is adjusted automatically using color temperature measured by image sensor and 1,005-segment RGB sensor. For best results, use type G or D lens. If optional flash unit is used, white balance reflects conditions in effect when the flash goes off.
 Incandescent	3,000*	Use under incandescent lighting.
 Fluorescent		Use under following seven light sources:
Sodium-vapor lamps	2,700*	Use under sodium-vapor lighting (found in sports venues).
Warm-white fluorescent	3,000*	Use under warm-white fluorescent lights.
White fluorescent	3,700*	Use under white fluorescent lights.
Cool-white fluorescent	4,200*	Use under cool-white fluorescent lights.
Day white fluorescent	5,000*	Use under daylight white fluorescent lights.
Daylight fluorescent	6,500*	Use under daylight fluorescent lights.
High temp. mercury-vapor	7,200*	Use under high color temperature light sources (e.g. mercury-vapor lamps).
 Direct sunlight	5,200*	Use with subjects lit by direct sunlight.

Option	Color temp. (K)	Description
 Flash	5,400*	Use with optional flash units.
 Cloudy	6,000*	Use in daylight under overcast skies.
 Shade	8,000*	Use in daylight with subjects in the shade.
 Choose color temp.	2,500–10,000	Choose color temperature from list of values (pg. 147).
PRE Preset manual	—	Use subject, light source, or existing photograph as reference for white balance (pg. 148).

* All values are approximate. Fine-tuning set to 0.

Auto white balance is recommended with most light sources. If the desired results can not be achieved with auto white balance, choose an option from the list above or use preset white balance.


White balance can be selected by pressing the **WB** button and rotating the main command dial until the desired setting is displayed in the rear control panel.



The White Balance Menu

White balance can also be adjusted using the [White balance] option in the shooting menu (pg. 290).

(Fluorescent)

Selecting  (fluorescent) with the **WB** button and main command dial selects the type of bulb chosen for the [Fluorescent] option in the white balance menu (pg. 290).

Studio Flash Lighting

Auto white balance may not produce the desired results with large studio flash units. Choose a color temperature, use preset white balance, or set white balance to [Flash] and use fine tuning to adjust white balance.

Color Temperature

The perceived color of a light source varies with the viewer and other conditions. Color temperature is an objective measure of the color of a light source, defined with reference to the temperature to which an object would have to be heated to radiate light in the same wavelengths. While light sources with a color temperature in the neighborhood of 5,000–5,500K appear white, light sources with a lower color temperature, such as incandescent light bulbs, appear slightly yellow or red. Light sources with a higher color temperature appear tinged with blue.

See Also

When [WB bracketing] is selected for Custom Setting e4 ([Auto bracketing set], pg. 328), the camera will create several images each time the shutter is released. White balance will be varied with each image, “bracketing” the value currently selected for white balance. See page 130 for more information.

Fine-Tuning White Balance

White balance can be “fine tuned” to compensate for variations in the color of the light source or to introduce a deliberate color cast into an image. White balance is fine tuned using the [White balance] option in the shooting menu or by pressing the **WB** button and rotating the sub-command dial.

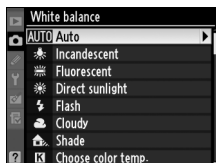
■ ■ The White Balance Menu

1 Select a white balance option.

Select [White balance] in the shooting menu (pg. 290), then highlight a white balance

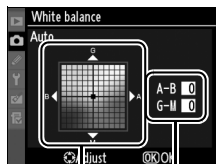


option and press ►. If an option other than [Fluorescent], [Choose color temp.], or [Preset manual] is selected, proceed to Step 2. If [Fluorescent] is selected, highlight a lighting type and press ►. If [Choose color temp.] is selected, highlight a color temperature and press ►. If [Preset manual] is selected, choose a preset as described on page 157 before proceeding.



2 Fine tune white balance.

Use the multi selector to fine-tune white balance. White balance can be fine tuned on the amber (A)–blue (B) axis and the green (G)–magenta (M) axis. The horizontal (amber–blue) axis corresponds to color temperature, with each increment equivalent to about 5 mired. The vertical (green–magenta) axis has the similar effects to the corresponding color compensation (CC) filters.

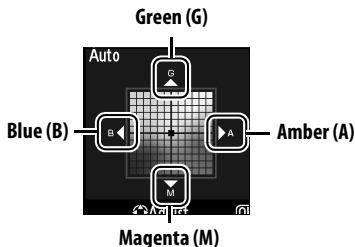


Coordinates Adjustment

Increase green



Increase magenta



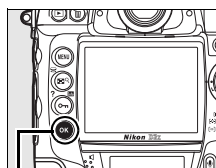
Increase blue



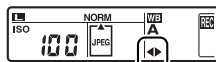
Increase amber

3 Press **OK**.


Press **OK** to save settings and return to the shooting menu. If white balance has been fine-tuned on the A-B axis, a **◀▶** icon will be displayed in the rear control panel.



OK button



White Balance Fine Tuning

The colors on the fine-tuning axes are relative, not absolute. For example, moving the cursor to **B** (blue) when a “warm” setting such as  (incandescent) is selected for white balance will make photographs slightly “colder” but will not actually make them blue.

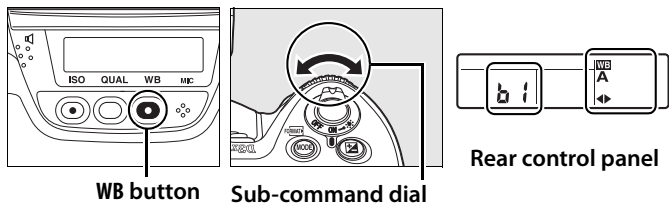
“Mired”

Any given change in color temperature produces a greater difference in color at low color temperatures than it would at higher color temperatures. For example, a change of 1000 K produces a much greater change in color at 3000 K than at 6000 K. Mired, calculated by multiplying the inverse of the color temperature by 10^6 , is a measure of color temperature that takes such variation into account, and as such is the unit used in color-temperature compensation filters. E.g.:

- 4000 K–3000 K (a difference of 1000 K)=83 mired
- 7000 K–6000 K (a difference of 1000 K)=24 mired

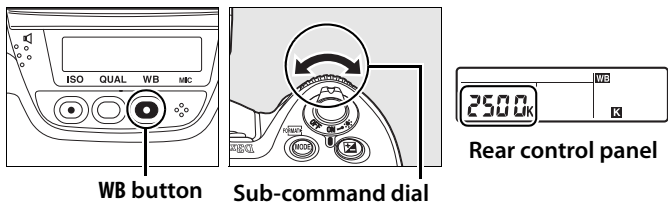
■ ■ The WB Button

At settings other than **☑** ([Choose color temp.]) and **PRE** ([Preset manual]), the **WB** button can be used to fine-tune white balance on the amber (A)–blue (B) axis (pg. 144; to fine-tune white balance when **☑** or **PRE** is selected, use the shooting menu as described on page 143). Six settings in both directions are available; each increment is equivalent to about 5 mired (pg. 145). Press the **WB** button and rotate the sub-command dial until the desired value is displayed in the rear control panel. Rotating the sub-command dial to the left increases the amount of amber (A). Rotating the sub-command dial to the right increases the amount of blue (B). At settings other than 0, a ◀▶ icon appears in the rear control panel.



Choosing a Color Temperature

When **K** ([Choose color temp.]) is selected for white balance, color temperature can be selected by pressing the **WB** button and rotating the sub-command dial. The color temperature is displayed in the rear control panel:



✓ Choose Color Temperature

Note that the desired results will not be obtained with flash or fluorescent lighting. Choose **⚡** ([Flash]) or **☀** ([Fluorescent]) for these sources. With other light sources, take a test shot to determine if the selected value is appropriate.

✍ The White Balance Menu

Color temperature can also be selected in the white balance menu. Note that the color temperature with the **WB** button and the sub-command dial replaces the value selected in the white balance menu.

Preset Manual

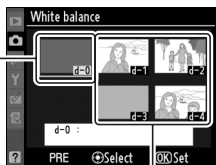
Preset manual is used to record and recall custom white balance settings for shooting under mixed lighting or to compensate for light sources with a strong color cast. Two methods are available for setting preset white balance:

Method	Description
Direct measurement	Neutral gray or white object is placed under lighting that will be used in final photograph and white balance is measured by camera (pg. 150).
Copy from existing photograph	White balance is copied from photo on memory card (pg. 155).

The camera can store up to five values for preset white balance in presets d-0 through d-4. A descriptive comment can be added to any white balance preset (pg. 159).

d-0

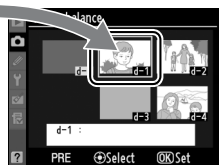
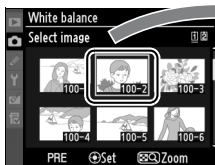
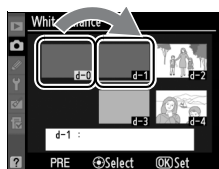
Stores last value measured for white balance (pg. 150). This preset is overwritten when a new value is measured.



d-1-d-4

Store values copied from d-0 (pg. 154).

Store values copied from images on memory card (pg. 155).



White Balance Presets

Changes to white balance presets apply to all shooting menu banks (pg. 291). A confirmation dialog will be displayed if the user attempts to change a white balance preset created in another shooting menu bank (no warning is displayed for preset d-0).

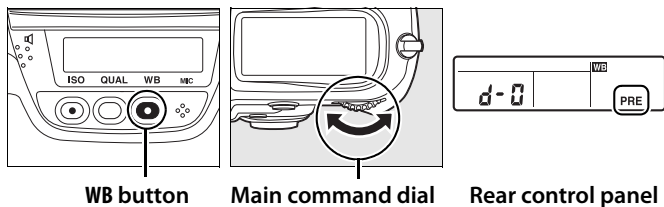
■ ■ *Measuring a Value for White Balance*

1 Light a reference object.

Place a neutral gray or white object under the lighting that will be used in the final photograph. In studio settings, a standard gray panel can be used as a reference object. Note that exposure is automatically increased by 1 EV when measuring white balance; in exposure mode *M*, adjust exposure so that the electronic analog exposure displays shows ± 0 (pg. 122).

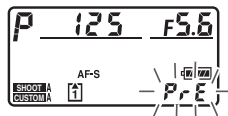
2 Set white balance to PRE ([Preset manual]).

Press the **WB** button and rotate the main command dial until **PRE** is displayed in the rear control panel.

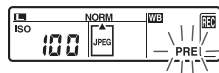


3 Select direct measurement mode.

Release the **WB** button briefly and then press the button until the **PRE** icon starts to flash. A flashing **PRE** will also appear in the top control panel and viewfinder. At default settings, the displays will flash for about six seconds.



Top control panel



Rear control panel



Viewfinder

4 Measure white balance.

Before the indicators stop flashing, frame the reference object so that it fills the viewfinder and press the shutter-release button all the way down. The camera will measure a value for white balance and store it in preset d-0. No photograph will be recorded; white balance can be measured accurately even when the camera is not in focus.



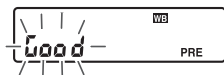
WB

5 Check the results.

If the camera was able to measure a value for white balance, **Good** will flash in the control panels, while the viewfinder will show a flashing **Gd**. At default settings, the displays will flash for about six seconds.



Top control panel

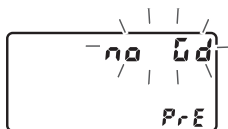


Rear control panel



Viewfinder

If lighting is too dark or too bright, the camera may be unable to measure white balance. A flashing **no Gd** will appear in the control panels and viewfinder (at default settings, the displays will flash for about six seconds). Press the shutter-release button halfway to return to Step 4 and measure white balance again.



Top control panel



Rear control panel



Viewfinder

6 Select preset d-0.

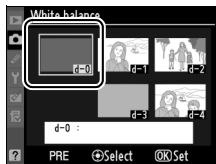
If the new value for preset white balance will be used immediately, select preset d-0 by pressing the **WB** button and rotating the sub-command dial until d-0 is displayed in the rear control panel.

✔ Direct Measurement Mode

If no operations are performed while the displays are flashing, direct measurement mode will end in the time selected for Custom Setting c2 ([Auto meter-off delay], pg. 318). The default setting is six seconds.

✎ Preset d-0

The new value for white balance will be stored in preset d-0, automatically replacing the previous value for this preset (no confirmation dialog will be displayed). A thumbnail will be displayed in the preset white balance list.



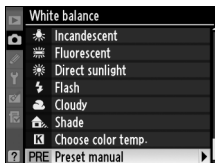
To use the new value for white balance, select preset d-0 (if no value has been measured for white balance before d-0 is selected, white balance will be set to a color temperature of 5,200 K, the same as [Direct sunlight]). The new white balance value will remain in preset d-0 until white balance is measured again. By copying preset d-0 to one of the other presets before measuring a new value for white balance, up to five white balance values can be stored (pg. 154).

■ Copying White Balance from d-0 to Presets d-1–d-4

Follow the steps below to copy a measured value for white balance from d-0 to any of the other presets (d-1–d-4).

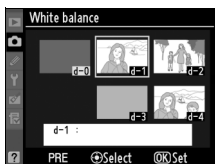
1 Select PRE ([Preset manual]).

Highlight [Preset manual] in the white balance menu (pg. 140) and press ►.



2 Select a destination.

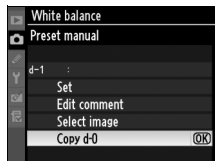
Highlight the destination preset (d-1 to d-4) and press the center of the multi selector.



WB

3 Copy d-0 to the selected preset.

Highlight [Copy d-0] and press OK. If comment has been created for d-0 (pg. 159), the comment will be copied to the comment for the selected preset.

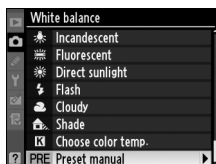


■ Copying White Balance from a Photograph (d-1–d-4 Only)

Follow the steps below to copy a value for white balance from a photograph on the memory card to a selected preset (d-1–d-4 only). Existing white balance values can not be copied to preset d-0.

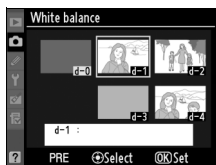
1 Select PRE ([Preset manual]).

Highlight [Preset manual] in the white balance menu (pg. 140) and press ►.



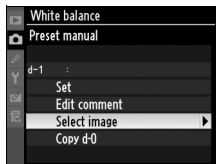
2 Select a destination.

Highlight the destination preset (d-1 to d-4) and press the center of the multi selector.




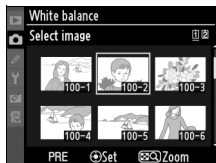
3 Choose [Select image].




Highlight [Select image] and press ►.



4 Highlight a source image.

Highlight the source image. To view the highlighted image full frame, press the  button.



If two memory cards are inserted, the slot can be selected by holding the  button and pressing . The menu shown at right will be displayed (pg. 228); highlight the desired slot and press .





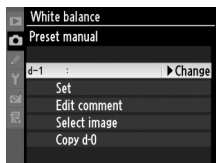
5 Copy white balance.

Press the center of the multi selector to copy the white balance value for the highlighted photograph to the selected preset. If the highlighted photograph has a comment (pg. 350), the comment will be copied to the comment for the selected preset.



Choosing a White Balance Preset

Press  to highlight the current white balance preset (d-0–d-4) and press  to select another preset.

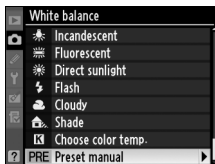


■ Selecting a White Balance Preset

To set white balance to a preset value:

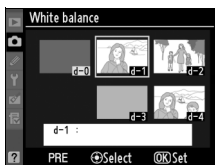
1 Select PRE ([Preset manual]).

Highlight [Preset manual] in the white balance menu (pg. 140) and press ►.



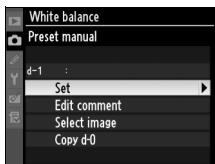
2 Select a preset.

Highlight the desired preset and press the center of the multi selector. To select the highlighted preset and display fine tuning menu (pg. 143) without completing the next step, press **OK** instead of pressing the center of the multi selector.



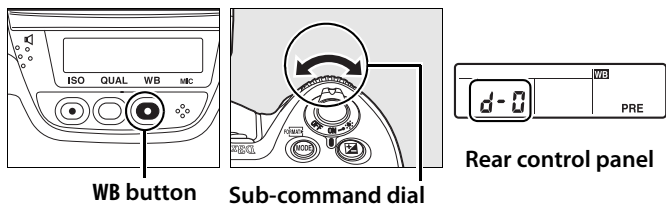
3 Select [Set].

Highlight [Set] and press ►. Fine tuning menu for the selected white balance preset is displayed (pg. 143).



Selecting a White Balance Preset: the WB Button

At a setting of **PRE** ([Preset manual]), presets can also be selected by pressing the **WB** button and rotating the sub-command dial. The current preset is displayed in the rear control panel while the **WB** button is pressed.

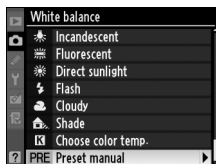


■ Entering a Comment

Follow the steps below to enter a descriptive comment of up to thirty-six characters for a selected white balance preset.

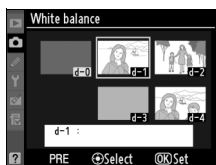
1 Select PRE ([Preset manual]).

Highlight [Preset manual] in the white balance menu (pg. 140) and press ►.



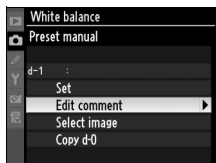
2 Select a preset.

Highlight the desired preset and press the center of the multi selector.



3 Select [Edit comment].

Highlight [Edit comment] and press ►.



4 Edit the comment.

Edit the comment as described on page 292.

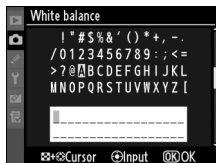




Image Enhancement

This chapter describes how to optimize sharpening, contrast, brightness, saturation and hue using Picture Controls, how to preserve detail in highlights and shadows using active D-lighting, and how to choose a color space.

Picture Controls	pg. 162
Creating Custom Picture Controls	pg. 170
Active D-Lighting	pg. 181
Color Space.....	pg. 183



Picture Controls

Nikon's unique Picture Control system makes it possible to share image processing settings among compatible devices and software. Select from the Picture Controls provided with the camera to instantly adjust image processing settings, or make independent adjustments to sharpening, contrast, brightness, saturation, and hue. These settings can be saved under new names as custom Picture Controls to be recalled or edited at will. Custom Picture Controls can also be saved to the memory card for use in compatible software, and software-created Picture Controls can be loaded into the camera. Any given set of Picture Controls will produce nearly the same results on all cameras that support the Nikon Picture Control system.



■ ■ Using Picture Controls

Picture Controls can be used as described below.

- **Select Nikon Picture Controls** (pg. 164): Select an existing Nikon Picture Control.
- **Modify existing Picture Controls** (pg. 166): Modify an existing Picture Control to create a combination of sharpening, contrast, brightness, saturation, and hue for a particular scene or effect.
- **Create custom Picture Controls** (pg. 170): Store modified Picture Controls under unique names and recall or edit them as desired.
- **Share custom Picture Controls** (pg. 174): Custom Picture Controls created with the camera can be saved to the memory card for use in ViewNX (supplied) and other compatible software, or software-created custom Picture Controls can be loaded into the camera.
- **Manage custom Picture Controls** (pg. 177): Rename or delete custom Picture Controls.







✍ Nikon Picture Controls Versus Custom Picture Controls

The Picture Controls supplied by Nikon are referred to as *Nikon Picture Controls*. In addition to the Nikon Picture Controls supplied with the camera, *optional Picture Controls* are available for download from Nikon websites. *Custom Picture Controls* are created through modifications to existing Nikon Picture Controls. Both Nikon and custom Picture Controls can be shared among compatible devices and software.

Selecting Nikon Picture Controls

The camera offers four preset Nikon Picture Controls. Choose a Picture Control according to the subject or type of scene.

Option	Description
 Standard	Standard processing for balanced results. Recommended for most situations.
 Neutral	Minimal processing for natural results. Choose for photographs that will later be extensively processed or retouched.
 Vivid	Pictures are enhanced for a vivid, photoprint effect. Choose for photographs that emphasize primary colors.
 Monochrome	Take monochrome photographs.

■ ■ Choosing a Picture Control

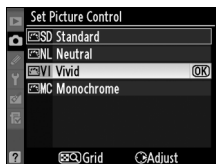
1 Select [Set Picture Control].

In the shooting menu (pg. 290), highlight [Set Picture Control] and press **▶**.








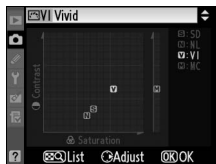
2 Select a Picture Control.

Highlight the desired Picture Control and press **OK**.




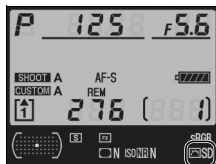
The Picture Control Grid

Pressing the  button in Step 2 displays a Picture Control grid showing the contrast and saturation for the selected Picture Control in relation to the other Picture Controls (only contrast is displayed when [Monochrome] is selected). To select a different Picture Control, press  or , then press  to display Picture Control options and press .



The Picture Control Indicator

The current Picture Control is shown in the shooting information display when the  button is pressed.



**Picture Control
indicator**



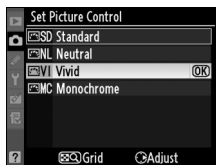
Modifying Existing Picture Controls

Existing Nikon or custom Picture Controls can be modified to suit the scene or the user's creative intent. Choose a balanced combination of settings using [Quick adjust], or make manual adjustments to individual settings.



1 Select a Picture Control.


Highlight the desired Picture Control in the [Set Picture Control] menu (pg. 164) and press ►.



2 Adjust settings.

Press ▲ or ▼ to highlight the desired setting and press ◀ or ▶ to choose a value (pg. 167).

Repeat this step until all settings have been adjusted, or

select [Quick adjust] (pg. 167) to choose a preset combination of settings. Default settings can be restored by pressing the  button.



3 Press .

Modifications to Original Picture Controls

Picture Controls that have been modified from default settings are indicated by an asterisk ("*") in the [Set Picture Control] menu.



Picture Control Settings

Option	Description	
Quick adjust	Choose from options between [-2] and [+2] to reduce or exaggerate the effect of the selected Picture Control (note that this resets all manual adjustments). For example, choosing positive values for [Vivid] makes pictures more vivid. Not available with [Neutral], [Monochrome], or custom Picture Controls.	
Manual adjustments (all Picture Controls)	Sharpening	Control the sharpness of outlines. Select [A] to adjust sharpening automatically according to the type of scene, or choose from values between [0] (no sharpening) and [9] (the higher the value, the greater the sharpening).
	Contrast	Select [A] to adjust contrast automatically according to the type of scene, or choose from values between [-3] and [+3] (choose lower values to prevent highlights in portrait subjects from being “washed out” in direct sunlight, higher values to preserve detail in misty landscapes and other low-contrast subjects).
	Brightness	Choose [-1] for reduced brightness, [+1] for enhanced brightness. Does not affect exposure.
Manual adjustments (non-monochrome only)	Saturation	Control the vividness of colors. Select [A] to adjust saturation automatically according to the type of scene, or choose from values between [-3] and [+3] (lower values reduce saturation and higher values increase it).
	Hue	Choose negative values (to a minimum of [-3]) to make reds more purple, blues more green, and greens more yellow, positive values (up to [+3]) to make reds more orange, greens more blue, and blues more purple.
Manual adjustments (monochrome only)	Filter effects	Simulate the effect of color filters on monochrome photographs. Choose from [Off] (the default setting), yellow, orange, red, and green (pg. 169).
	Toning	Choose the tint used in monochrome photographs from [B&W] (black-and-white, the default setting), [Sepia], [Cyanotype] (blue-tinted monochrome), [Red], [Yellow], [Green], [Blue Green], [Blue], [Purple Blue], and [Red Purple] (pg. 169).

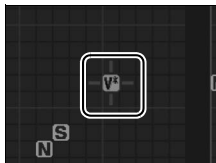


✓ Active D-Lighting



[Contrast] and [Brightness] can not be adjusted when Active D-Lighting (pg. 181) is on. Any manual adjustments currently in effect will be lost when Active D-Lighting is turned on.

✓ "A" (Auto)

Results for auto contrast and saturation vary with exposure and the position of the subject in the frame. Use a type G or D lens for best results. The icons for Picture Controls that use auto contrast and saturation are displayed in green in the Picture Control grid, and lines appear parallel to the axes of the grid.



✎ The Picture Control Grid

Pressing the  button in Step 2 displays a Picture Control grid showing the contrast and saturation for the selected Picture Control in relation to the other Picture Controls (only contrast is displayed when [Monochrome] is selected). Release the  button to return to the Picture Control menu.



✎ Previous Settings

The line under the value display in the Picture Control setting menu indicates the previous value for the setting. Use this as a reference when adjusting settings.



Filter Effects (Monochrome Only)

The options in this menu simulate the effect of color filters on monochrome photographs. The following filter effects are available:

Option	Description
Y Yellow	Enhances contrast. Can be used to tone down the brightness of the sky in landscape photographs.
O Orange	Orange produces more contrast than yellow, red more contrast than orange.
R Red	Softens skin tones. Can be used for portraits.
G Green	

Note that the effects achieved with [Filter effects] are more pronounced than those produced by physical glass filters.

Toning (Monochrome Only)

Pressing ▼ when [Toning] is selected displays saturation options. Press ◀ or ▶ to adjust saturation. Saturation control is not available when [B&W] (black-and-white) is selected.



Custom Picture Controls

The options available with custom Picture Controls are the same as those on which the custom Picture Control was based.

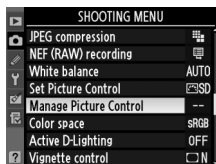


Creating Custom Picture Controls

The Nikon Picture Controls supplied with the camera can be modified and saved as custom Picture Controls.

1 Select [Manage Picture Control].

In the shooting menu (pg. 290), highlight [Manage Picture Control] and press **▶**.



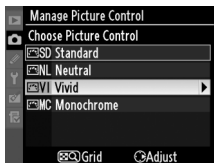
2 Select [Save/edit].

Highlight [Save/edit] and press **▶**.



3 Select a Picture Control.

Highlight an existing Picture Control and press **▶**, or press **OK** to proceed to step 5 to save a copy of the highlighted Picture Control without further modification.



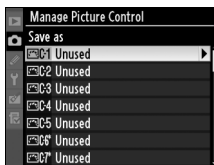
4 Edit the selected control.

See page 167 for more information. To abandon any changes and start over from default settings, press the **⌫** button. Press **OK** when settings are complete.



5 Select a destination.





Choose a destination for the custom Picture Control (C-1 through C-9) and press **▶**.



6 Name the Picture Control.


The text-entry dialog shown at right will be displayed. By default, new Picture

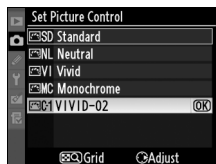
Controls are named by adding a two-digit number (assigned automatically) to the name of the existing Picture Control. This name can be edited to create a new name as described below.

To move the cursor in the name area, press the  button and press  or . To enter a new letter at the current cursor position, use the multi selector to highlight the desired character in the keyboard area and press the center of the multi selector. To delete the character at the current cursor position, press the  button.

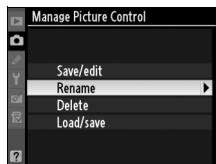


Custom Picture Control names can be up to 19 characters long. Any characters after the 19th will be deleted.

After entering the name, press . The new Picture Control will appear in the Picture Control list.



Custom Picture Controls can be renamed at any time using the [Rename] option in the [Manage Picture Control] menu.



Custom Picture Controls

Custom Picture Controls are not affected by [Reset shooting menu] (pg. 293).

Custom Picture Controls do not have a [Quick adjust] option (pg. 167). Custom Picture Controls based on [Monochrome] have [Filter effects] and [Toning] options in place of [Saturation] and [Hue] controls.

The Original Picture Control Icon

The Nikon Picture Control on which the custom Picture Control is based is indicated by an icon in the top right corner of the edit display.

Original Picture Control icon



Sharing Custom Picture Controls

Custom Picture Controls created using the Picture Control Utility available with ViewNX or optional software such as Capture NX 2 can be copied to a memory card and loaded into the camera, or custom Picture Controls created with the camera can be copied to the memory card to be used in compatible cameras and software.

■ Copying Custom Picture Controls to the Camera

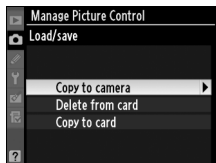
1 Select [Load/save].

In the [Manage Picture Control] menu, highlight [Load/save] and press **▶**.



2 Select [Copy to camera].

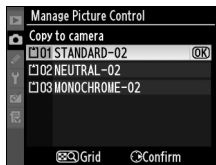
Highlight [Copy to camera] and press **▶**.



3 Select a Picture Control.

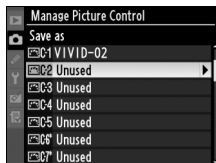
Highlight a custom Picture Control and either;

- press **▶** to view current Picture Control settings, or
- press **OK** to proceed to Step 4.



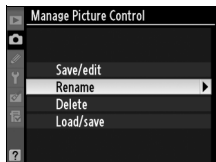
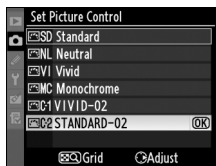
4 Select a destination.

Choose a destination for the custom Picture Control (C-1 through C-9) and press **▶**.



5 Name the Picture Control.

Name the Picture Control as described on page 172. The new Picture Control will appear in the Picture Control list and can be renamed at any time using the [Rename] option in the [Manage Picture Control] menu.



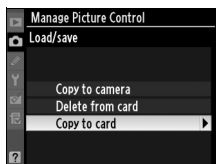
Use Slot 1

Slot 1 is used when saving custom Picture Controls to a memory card or copying custom Picture Controls to the camera. Cards in slot 2 can not be used.

■ Saving Custom Picture Controls to the Memory Card

1 Select [Copy to card].

After displaying the [Load/save] menu as described in Step 1 on page 174, highlight [Copy to card] and press ►.



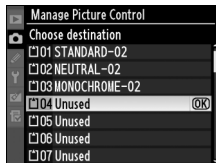
2 Select a Picture Control.

Highlight a custom Picture Control and press ►.



3 Choose a destination.

Choose a destination from slots 1 through 99 and press **OK** to save the selected Picture Control to the memory card.



Any Picture Controls that may already have been saved to the selected slot will be overwritten.

✎ Saving Custom Picture Controls

Up to 99 custom Picture Controls can be stored on the memory card at any one time. The memory card can only be used to store user-created custom Picture Controls. The Nikon Picture Controls supplied with the camera can not be copied to the memory card.

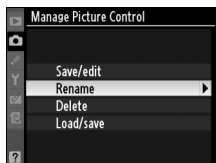
Managing Custom Picture Controls

Follow the steps below to rename or delete custom Picture Controls.

■ Renaming Custom Picture Controls

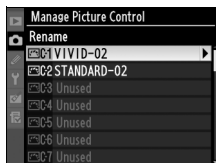
1 Select [Rename].

In the [Manage Picture Control] menu, highlight [Rename] and press ►.



2 Select a Picture Control.

Highlight a custom Picture Control (C-1 through C-9) and press ►.



3 Rename the Picture Control.

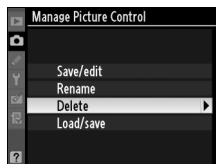
Rename the Picture Control as described on page 172.



■ Deleting Custom Picture Controls from the Camera

1 Select [Delete].

In the [Manage Picture Control] menu, highlight [Delete] and press **▶**.



2 Select a Picture Control.

Highlight a custom Picture Control (C-1 through C-9) and press **▶**.



3 Select [Yes].

Highlight [Yes] and press **OK** to delete the selected Picture Control.



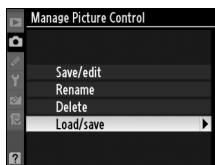
✎ Nikon Picture Controls

The Nikon Picture Controls supplied with the camera ([Standard], [Neutral], [Vivid], and [Monochrome]) can not be renamed or deleted.

■ ■ *Deleting Custom Picture Controls from the Memory Card*

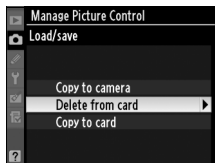
1 Select [Load/save].

In the [Manage Picture Control] menu, highlight [Load/save] and press ►.



2 Select [Delete from card].

Highlight [Delete from card] and press ►.



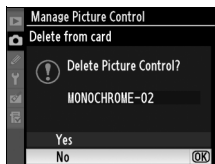
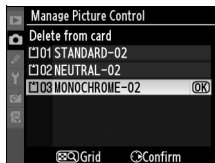
3 Select a Picture Control.

Highlight a custom Picture Control (slot1 through 99) and either:

- press **▶** to view current Picture Control settings, or

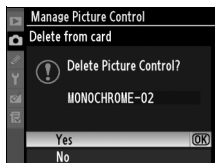


- press **OK** to display confirmation dialog shown at right.



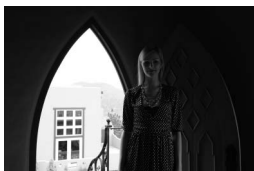
4 Select [Yes].

Highlight [Yes] and press **OK** to delete the selected Picture Control.

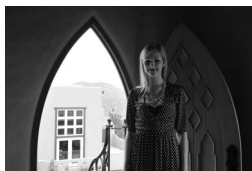


Active D-Lighting

Active D-Lighting preserves details in highlights and shadows, creating photographs with natural contrast. Use for high contrast scenes, for example when photographing brightly lit outdoor scenery through a door or window or taking pictures of shaded subjects on a sunny day.



Active D-Lighting off



Active D-Lighting:
Auto



Active D-Lighting off



Active D-Lighting:
High



To use Active D-Lighting:

1 Select [Active D-Lighting].

In the shooting menu (pg. 290), highlight [Active D-Lighting] and press **▶**.



2 Choose an option.

Highlight an option and press **OK**. Choose [Auto] to let the camera automatically select [High], [Normal], or [Low] according to shooting conditions.



✓ Active D-Lighting

When Active D-Lighting is on, the capacity of the memory buffer drops and additional time is required to record images (pg. 429). Matrix metering is recommended (pg. 110). Although exposure is in fact reduced to prevent loss of detail in highlights and shadows, highlights, underexposed areas, and mid-tones are automatically adjusted to prevent the resulting photograph from being underexposed. The [Brightness] and [Contrast] Picture Control settings (pg. 167) can not be adjusted while Active D-Lighting is in effect. Noise, distortion, or banding may be visible at high ISO sensitivities. In exposure mode *M*, an Active D-Lighting setting of [Auto] is equivalent to [Normal].

✓ "Active D-Lighting" versus "D-Lighting"

The [Active D-Lighting] option in the shooting menu adjusts exposure before shooting to optimize the dynamic range, while the [D-Lighting] option in the retouch menu optimizes dynamic range in images after shooting.

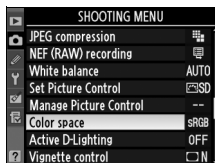
Color Space

The color space determines the gamut of colors available for color reproduction. Choose a color space according to how photographs will be processed on leaving the camera.

Option	Description
sRGB sRGB (default)	Choose for photographs that will be printed or used "as is," with no further modification.
Adobe Adobe RGB	This color space is capable of expressing a wider gamut of colors than sRGB, making it the preferred choice for images that will be extensively processed or retouched.

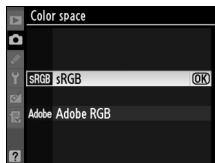
1 Select [Color space].

Highlight [Color space] in the shooting menu (pg. 290) and press ►.



2 Select a color space.

Highlight the desired option and press **OK**.



Color Space

Color spaces define the correspondence between colors and the numeric values that represent them in a digital image file. The sRGB color space is widely used, while the Adobe RGB color space is typically used in publishing and commercial printing. sRGB is recommended when taking photographs that will be printed without modification or viewed in applications that do not support color management, or when taking photographs that will be printed with ExifPrint, the direct printing option on some household printers, or kiosk printing or other commercial print services. Adobe RGB photographs can also be printed using these options, but colors will not be as vivid.

JPEG photographs taken in the Adobe RGB color space are Exif 2.21 and DCF 2.0 compliant; applications and printers that support Exif 2.21 and DCF 2.0 will select the correct color space automatically. If the application or device does not support Exif 2.21 and DCF 2.0, select the appropriate color space manually. An ICC color profile is embedded in TIFF photographs taken in the Adobe RGB color space, allowing applications that support color management to automatically select the correct color space. For more information, see the documentation provided with the application or device.



Nikon Software

The following Nikon software automatically selects the correct color space when opening photographs created with the D3X: ViewNX (supplied) and Capture NX 2 (available separately).



Flash Photography

– *Using Optional Flash Units*

This chapter describes how to use the camera with optional flash units that support the Nikon Creative Lighting System (CLS).

The Nikon Creative Lighting System (CLS)	pg. 186
Compatible Flash Units	pg. 187
CLS-Compatible Flash Units	pg. 187
Other Flash Units	pg. 191
i-TTL Flash Control.....	pg. 193
Flash Modes.....	pg. 194
FV Lock	pg. 198
Flash Contacts.....	pg. 201



The Nikon Creative Lighting System (CLS)

Nikon's advanced Creative Lighting System (CLS) offers improved communication between the camera and compatible flash units for improved flash photography. The Creative Lighting System supports the following features:

- **i-TTL flash control:** Improved through-the-lens (TTL) flash control for use with CLS (see page 193). Flash level is set using monitor pre-flashes to measure the light reflected by the subject, ensuring that the level is adjusted appropriately for ambient lighting.
- **Advanced Wireless Lighting:** Allows i-TTL flash control with remote wireless flash units.
- **FV lock** (pg. 198): Locks flash level at the metered value, allowing a series of photographs to be taken at the same flash level.
- **Auto FP High-Speed Sync** (pg. 197): Allows the flash to be used at the highest shutter speed supported by the camera, making it possible to choose the maximum aperture for reduced depth of field.



The CLS-compatible D3X can be used for flash photography when an optional Speedlight is mounted on the camera's accessory shoe. A flash can be used not only when natural lighting is inadequate, but also to fill in shadows, illuminate back-lit subjects, and even to add a catch light to the eyes of a portrait subject. See the Speedlight manual for details.

Compatible Flash Units


CLS-Compatible Flash Units

The D3X can be used with the following CLS-compatible flash units: the SB-900, SB-800, SB-600, SB-400, SB-R200, and SU-800.

■ ■ *The SB-900, SB-800, SB-600, SB-400, and SB-R200*

The principal features of these flash units are listed below.

Flash unit	SB-900 ¹	SB-800	SB-600	SB-400	SB-R200 ²
Feature					
Guide No. ³	34/111	38/125	30/98	21/69	10/33
Auto power zoom (mm)	17–200	24–105	24–85	— ⁴	— ⁵
Wide panel (mm)	12, 14, 17	14, 17	14	—	—
Head rotation	7° down, 90° up, 180° left, and right	7° down, 90° up, 180° left, 90° right	90° up, 180° left, 90° right	90° up	60° down (toward lens light axis), 45° up (away from light axis)

1 If a color filter is attached to the SB-900 when AUTO or  (flash) is selected for white balance, the camera will automatically detect the filter and adjust white balance appropriately.

2 Controlled remotely using optional SB-900 or SB-800 flash unit or SU-800 wireless Speedlight commander.

3 ISO 100, m/ft., 20°C (68°F), SB-900, SB-800, and SB-600 at 35 mm zoom head position; SB-900 with standard illumination.

4 27 mm zoom coverage.

5 24 mm zoom coverage.

■ ■ *SU-800 Wireless Speedlight Commander*

When mounted on a CLS-compatible camera, the SU-800 can be used as a commander for remote SB-900, SB-800, SB-600, or SB-R200 flash units. The SU-800 itself is not equipped with a flash.




Guide Number

To calculate the range of the flash at full power, divide the Guide Number by the aperture. For example, at ISO 100 the SB-800 has a Guide Number of 38 m or 125 ft.; its range at an aperture of f/5.6 is $38 \div 5.6$ or about 6.8 meters (or in feet, $125 \div 5.6 = 23$ ft. 7 in.). For each twofold increase in ISO sensitivity, multiply the Guide Number by the square root of two (approximately 1.4).



The following features are available with the SB-900, SB-800, SB-600, SB-400, SB-R200, and SU-800:

Flash unit		Advanced Wireless Lighting							
					Commander		Remote		
		SB-900 SB-800	SB-600	SB-400	SB-900 SB-800	SU-800 ¹	SB-900 SB-800	SB-600	SB-R200
Flash mode/feature									
i-TTL	i-TTL balanced fill-flash for digital SLR	✓ ²	✓ ²	✓ ³	✓	✓	✓	✓	✓
AA	Auto aperture	✓ ⁴	—	—	✓ ⁵	✓ ⁵	✓ ⁵	—	—
A	Non-TTL auto	✓ ⁶	—	—	✓ ⁵	—	✓ ⁵	—	—
GN	Range-priority manual	✓	—	—	—	—	—	—	—
M	Manual	✓	✓	—	✓	✓	✓	✓	✓
RPT	Repeating flash	✓	—	—	✓	✓	✓	✓	—
	Auto FP High-Speed Sync ⁷	✓	✓	—	✓	✓	✓	✓	✓
	FV lock	✓	✓	✓	✓	✓	✓	✓	✓
	AF-assist for multi-area AF ⁸	✓	✓	—	✓	✓	—	—	—
	Flash Color Information Communication	✓	✓	✓	✓	—	—	—	—
REAR	Rear-curtain sync	✓	✓	✓	✓	✓	✓	✓	✓
	Red-eye reduction	✓	✓	✓	✓	—	—	—	—
	Auto zoom	✓	✓	—	✓	—	—	—	—

- 1 Only available when SU-800 is used to control other flash units.
- 2 Standard i-TTL flash for digital SLR is used with spot metering or when selected with flash unit.
- 3 Standard i-TTL flash for digital SLR is used with spot metering.
- 4 Selected with flash unit. Non-TTL auto (A) selected automatically if non-CPU lens is attached without specifying lens data using [Non-CPU lens data].
- 5 Auto aperture (AA) is used regardless of mode selected with flash unit. Non-TTL auto (A) selected automatically if non-CPU lens is attached without specifying lens data using [Non-CPU lens data].
- 6 Selected with flash unit.
- 7 Select [1/250 s (Auto FP)] for Custom Setting e1 ([Flash sync speed], pg. 326).
- 8 CPU lens required.



The WG-AS1 Water Guard

The optional WG-AS1 is a water guard that covers the base of SB-900 flash units mounted on the D3X, increasing the SB-900's splash resistance by protecting the accessory shoe contacts from rain and spray.


Modeling Illumination

CLS-compatible Speedlights such as the SB-900, SB-800, and SB-600 emit a modeling flash when the camera depth-of-field preview button is pressed. This feature can be used with Advanced Wireless Lighting to preview the total lighting effect achieved with multiple flash units. Modeling illumination can be turned off using Custom Setting e3 [Modeling flash] (pg. 327).



Other Flash Units

The following flash units can be used in non-TTL auto and manual modes. If they are set to TTL, the camera shutter-release button will lock and no photographs can be taken.

Speedlight	SB-80DX, SB-28DX, SB-28, SB-26, SB-25, SB-24	SB-50DX	SB-30, SB-27 ¹ , SB-22s, SB-22, SB-20, SB-16B, SB-15	SB-23, SB-29 ² , SB-21B ² , SB-29s ²
A Non-TTL auto	✓	—	✓	—
M Manual	✓	✓	✓	✓
 Repeating flash	✓	—	—	—
REAR Rear-curtain sync	✓	✓	✓	✓

1 Flash mode is automatically set to TTL and shutter-release is disabled. Set flash unit to **A** (non-TTL auto flash).

2 Autofocus is only available with AF-Micro lenses (60 mm, 105 mm, or 200 mm).

Notes on Optional Speedlights

Refer to the Speedlight manual for detailed instructions. If the Speedlight supports the Nikon Creative Lighting System, refer to the section on CLS-compatible digital SLR cameras. The D3X is not included in the “digital SLR” category in the SB-80DX, SB-28DX, and SB-50DX manuals.

i-TTL flash control can be used at ISO sensitivities between 100 and 1600. At values over 1600, the desired results may not be achieved at some ranges or aperture settings. If the flash-ready indicator blinks for about three seconds after a photograph is taken, the flash has fired at full power and the photograph may be underexposed.



The SB-900, SB-800, SB-600, and SB-400 provide red-eye reduction in red-eye reduction and red-eye reduction with slow sync modes, while the SB-900, SB-800, SB-600, and SU-800 provide AF-assist illumination when the conditions for AF-assist illumination are met. When used with AF lenses with focal lengths of 17–135 mm, the SB-900 provides AF-assist illumination (active AF-assist illumination) for all focus points; note, however, that autofocus is available only with the following focus points:

17–19 mm		20–105 mm		106–135 mm	
-----------------	---	------------------	---	-------------------	---

When used with AF lenses with focal lengths of 24–105 mm, the SB-800, SB-600, and SU-800 provide AF-assist illumination to assist autofocus for the following focus points:

24–34 mm		35–49 mm		50–105 mm	
-----------------	---	-----------------	---	------------------	---

In programmed auto, the maximum aperture (minimum f-number) is limited according to sensitivity (ISO equivalency), as shown below:

Maximum aperture at ISO equivalent of:				
100	200	400	800	1600
4	4.8	5.6	6.7	8

For each one-step increase in sensitivity (e.g., from 200 to 400), aperture is stopped down by half an f-stop. If the maximum aperture of the lens is smaller than given above, the maximum value for aperture will be the maximum aperture of the lens.

When an SC-series 17, 28, or 29 sync cable is used for off-camera flash photography, correct exposure may not be achieved in i-TTL mode. We recommend that you choose spot metering to select standard i-TTL flash control. Take a test shot and view the results in the monitor.

In i-TTL, use the flash panel or bounce adapter provided with the flash unit. Do not use other panels such as diffusion panels, as this may produce incorrect exposure.

i-TTL Flash Control

When a CLS-compatible flash unit is set to TTL, the camera automatically selects one of the following types of flash control:





i-TTL balanced fill-flash for digital SLR: Flash unit emits series of nearly invisible preflashes (monitor preflashes) immediately before main flash. Preflashes reflected from objects in all areas of frame are picked up by 1,005-segment RGB sensor and are analyzed in combination with range information from matrix metering system to adjust flash output for natural balance between main subject and ambient background lighting. If type G or D lens is used, distance information is included when calculating flash output. Precision of calculation can be increased for non-CPU lenses by providing lens data (focal length and maximum aperture; see pg. 218). Not available when spot metering is used.


Standard i-TTL flash for digital SLR: Flash output adjusted to bring lighting in frame to standard level; brightness of background is not taken into account. Recommended for shots in which main subject is emphasized at expense of background details, or when exposure compensation is used. Standard i-TTL flash for digital SLR is activated automatically when spot metering is selected.



Flash Modes


The camera supports the following flash modes:

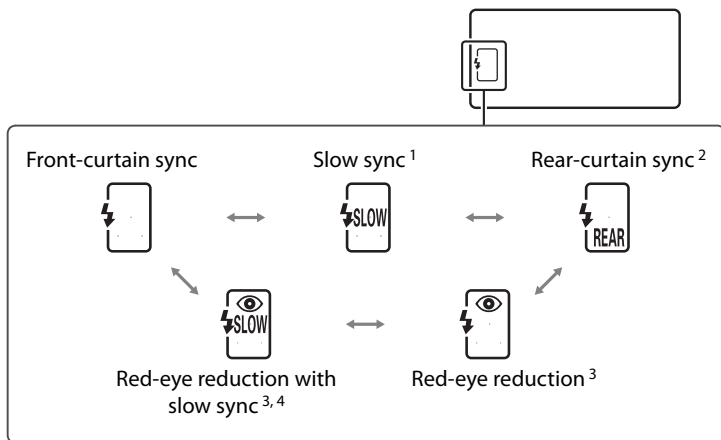
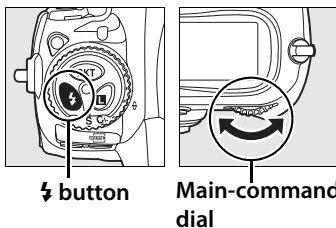
Flash mode	Description
 Front-curtain sync	This mode is recommended for most situations. In programmed auto and aperture-priority auto modes, shutter speed will automatically be set to values between $1/250$ and $1/60$ s ($1/8,000$ to $1/60$ s with Auto FP High-Speed Sync).
 Slow sync	Flash is combined with shutter speeds as slow as 30 s to capture both subject and background at night or under dim light. This mode is only available in exposure modes P and A . Tripod is recommended to prevent blurring caused by camera shake.
 Rear-curtain sync	In exposure modes S and M , flash fires just before the shutter closes. Use to create effect of a stream of light behind moving objects. In exposure modes P and A , slow rear-curtain sync is used to capture both subject and background. Tripod is recommended to prevent blurring caused by camera shake.
 Red-eye reduction	In this mode (available only with SB-900, SB-800, SB-600, and SB-400), red-eye reduction pre-flash lights for approximately one second before main flash. Pupils in subject's eyes to contract, reducing "red-eye" effect sometimes caused by flash. Owing to one-second shutter-release delay, this mode is not recommended with moving subjects or in other situations in which quick shutter response is required. Avoid moving camera while red-eye reduction pre-flash is lit.





Flash mode	Description
 <p data-bbox="117 200 285 291">Red-eye reduction with slow sync</p>	<p data-bbox="298 123 928 281">Combines red-eye reduction with slow sync. Use for portraits taken against a backdrop of night scenery. Available only with SB-900, SB-800, SB-600, and SB-400 in exposure modes P and A. Tripod is recommended to prevent blurring caused by camera shake.</p>



■ ■ Choosing a Flash Mode

To choose the flash mode, press the  button and rotate the main command dial until the desired flash mode is selected in the top control panel:



- 1 Available only in exposure modes *P* and *A*. In modes *S* and *M*, front-curtain sync is selected when the  button is released.
- 2 In exposure modes *P* and *A*, flash-sync mode will be set to slow rear-curtain sync when the  button is released.
- 3  icon blinks if flash unit does not support red-eye reduction.
- 4 Red-eye reduction with slow sync is available only in exposure modes *P* and *A*. In modes *S* and *M*, red-eye reduction is selected when the  button is released.



Studio Flash Systems

Rear-curtain sync can not be used with studio flash systems, as the correct synchronization can not be obtained.

Shutter Speed and Aperture

Shutter speed and aperture can be set as follows when a Speedlight is used:

Mode	Shutter speed	Aperture	See page
<i>P</i>	Set automatically by camera ($1/250$ s– $1/60$ s) ^{1,2}	Set automatically by camera	114
<i>S</i>	Value selected by user ($1/250$ s–30 s) ²		116
<i>A</i>	Set automatically by camera ($1/250$ s– $1/60$ s) ^{1,2}	Value selected by user ³	118
<i>M</i>	Value selected by user ($1/250$ s–30 s) ²		120

- 1 Shutter speed may be set as slow as 30s in slow sync, slow rear-curtain sync, and slow sync with red-eye reduction flash modes.
- 2 Speeds as fast as $1/8,000$ s are available with optional SB-900, SB-800, and SB-600 flash units when [1/250 s (Auto FP)] is selected for Custom Setting e1 ([Flash sync speed], pg. 326).
- 3 Flash range varies with aperture and ISO sensitivity. When setting aperture in exposure modes *A* and *M*, consult the table of flash ranges provided with optional Speedlight.

See Also

For information on choosing a flash sync speed, see Custom Setting e1 ([Flash sync speed], pg. 326). For information on choosing the slowest shutter speed available when using the flash, see Custom Setting e2 ([Flash shutter speed], pg. 327).



FV Lock

This feature is used to lock flash output, allowing photographs to be recomposed without changing the flash level and ensuring that flash output is appropriate to the subject even when the subject is not positioned in the center of the frame. Flash output is adjusted automatically for any changes in ISO sensitivity and aperture. FV lock is available with CLS compatible flash units only.

To use FV lock:

1 Assign FV lock to the Fn button.

Select [FV lock] for Custom Setting f4 ([Assign FUNC. button] > [FUNC. button press], pg. 333).



2 Attach a CLS-compatible flash unit.

Mount an SB-900, SB-800, SB-600, SB-400, or SU-800 on the camera accessory shoe.

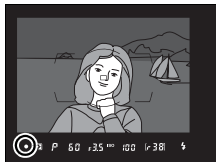


3 Set the flash unit to TTL or AA mode.

Turn the flash unit on and set the flash mode to TTL or AA. See the Speedlight instruction manual for details.

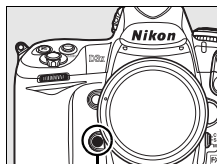
4 Focus.

Position the subject in the center of the frame and press the shutter-release button halfway to focus.

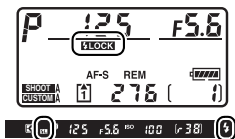


5 Lock flash level.

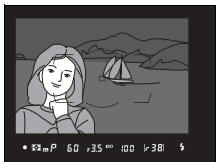
After confirming that the flash ready indicator (⚡) is displayed in the viewfinder, press the **Fn** button. The flash will emit a monitor preflash to determine the appropriate flash level. Flash output will be locked at this level and FV lock icons (⚡LOCK and **FL**) will appear in the top control panel and viewfinder.



Fn button



6 Recompose the photograph.



7 Take the photograph.

Press the shutter-release button the rest of the way down to shoot. If desired, additional pictures can be taken without releasing FV lock.

8 Release FV lock.

Press the **Fn** button to release FV lock. Confirm that the FV lock icons (**LOCK** and **AF**) are no longer displayed in the top control panel and viewfinder.



Metering

The metering areas for FV lock are as follows:

Speedlight	Flash mode	Metered area
Stand-alone flash unit	i-TTL	5-mm circle in center of frame
	AA	Area metered by flash exposure meter
Used with other flash units (Advanced Wireless Lighting)	i-TTL	Entire frame
	AA	Area metered by flash exposure meter
	A (master flash)	

See Also

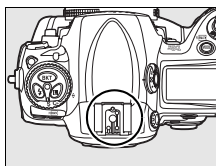
For information on using the depth-of-field preview or **AE-L/AF-L** button for FV lock, see Custom Setting f5 ([Assign preview button], pg. 339) or Custom Setting f6 ([Assign AE-L/AF-L button], pg. 340).

Flash Contacts

The camera is equipped with an accessory shoe for attaching optional flash units directly to the camera and a sync terminal that allows flash units to be connected via a sync cable. When an optional flash unit is attached, the flash will fire whenever the shutter is released.

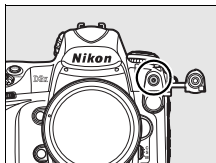
■ ■ *The Accessory Shoe*

Use the accessory shoe to mount optional flash units directly on the camera without a sync cable (pg. 187). The accessory shoe is equipped with a safety lock for Speedlights with a locking pin, such as the SB-900, SB-800, SB-600, and SB-400.



■ ■ *The Sync Terminal*

A sync cable can be connected to the sync terminal as required. Do not connect another flash unit via a sync cable when performing rear-curtain sync flash photography with a flash unit mounted on the camera accessory shoe.



✓ **Use Only Nikon Flash Accessories**

Use only Nikon Speedlights. Negative voltages or voltages over 250 V applied to the accessory shoe could not only prevent normal operation, but damage the sync circuitry of the camera or flash. Before using a Nikon Speedlight not listed in this section, contact a Nikon-authorized service representative for more information.





Other Shooting Options

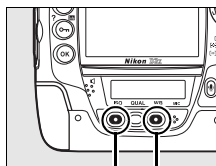
This chapter covers restoring default settings, making multiple exposures, interval timer photography, and using GPS units and non-CPU lenses.

Two-Button Reset: Restoring Default Settings	pg. 204
Multiple Exposure	pg. 206
Interval Timer Photography	pg. 211
Non-CPU Lenses	pg. 218
Using a GPS Unit.....	pg. 221



Two-Button Reset: Restoring Default Settings

The camera settings listed below can be restored to default values by holding the **ISO** and **WB** buttons down together for more than two seconds (these buttons are marked by a green dot). The control panels turn off briefly while settings are reset.



ISO WB
button button

Option	Default	Option	Default
Focus point	Center	Shutter-speed lock	Off
Exposure mode	Programmed auto	Bracketing	Off ²
Flexible program	Off	Flash mode	Front-curtain sync
Exposure compensation	Off	FV lock	Off
AE hold	Off ¹	Multiple exposure	Off
Aperture lock	Off		

1 Custom Setting f6 ([Assign AE-L/AF-L button], pg. 340) is unaffected.

2 Number of shots is reset to zero. Bracketing increment is reset to 1EV (exposure/flash bracketing) or 1 (white balance bracketing).

The following shooting-menu options will also be reset. Only settings in the bank currently selected using the [Shooting menu bank] option will be reset (pg. 291). Settings in the remaining banks are unaffected.

Option	Default	Option	Default
Image quality	JPEG Normal	White balance	Auto *
Image size	Large	ISO sensitivity	100

* Fine-tuning off.

If the current Picture Control has been modified, existing settings for the Picture Control will also be restored.



See Also

See page 422 for a list of default settings.

Multiple Exposure

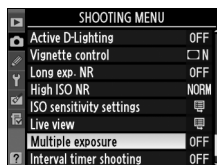
Follow the steps below to record a series of two to ten exposures in a single photograph. Multiple exposures can be recorded at any image quality setting, and produce results with colors noticeably better than photographs combined in an imaging application because they make use of RAW data from the camera image sensor.

■ Creating a Multiple Exposure

Note that at default settings, shooting will end and a multiple exposure will be recorded automatically if no operations are performed for 30 s.

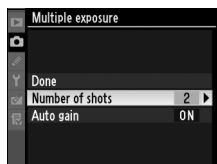
1 Select [Multiple exposure].

Highlight [Multiple exposure] in the shooting menu (pg. 290) and press ►.



2 Select [Number of shots].

Highlight [Number of shots] and press ►.

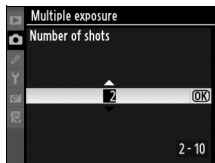


✎ Extended Recording Times

For an interval between exposures of more than 30 s, select [On] for the [Image review] (pg. 287) option in the playback menu and extend the monitor-off delay using Custom Setting c4 ([Monitor off delay], pg. 319). The maximum interval between exposures is 30 s longer than the option selected for Custom Setting c4.

3 Select the number of shots.

Press ▲ or ▼ to choose the number of exposures that will be combined to form a single photograph and press **OK**.



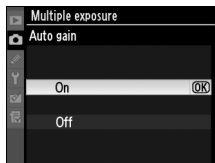
4 Select [Auto gain].

Highlight [Auto gain] and press ►.



5 Set gain.

Highlight one of the following options and press **OK**.




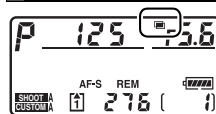
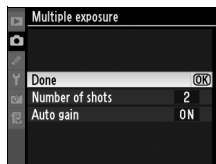
Option	Description
On (default)	Gain adjusted according to number of exposures actually recorded (gain for each exposure is set to $1/2$ for 2 exposures, $1/3$ for 3 exposures, etc.).
Off	Gain is not adjusted when recording multiple exposure. Recommended if background is dark.



6 Select [Done].

Highlight [Done] and press .



A  icon will be displayed in the top control panel. To exit without taking a multiple exposure, select [Multiple exposure] > [Reset] in the shooting menu.

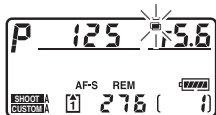


7 Frame a photograph, focus, and shoot.

In continuous high-speed and continuous low-speed release modes (pg. 86), the camera will record all exposures in a single burst. In single-frame release mode, one photograph will be taken each time the shutter-release button is pressed; continue shooting until all exposures have been recorded (for information on interrupting a multiple exposure before all photographs are recorded, see page 210).



The  icon will blink until shooting ends. When shooting ends, multiple exposure mode will end and the  icon will no longer be displayed. Repeat steps 1–7 to take additional multiple exposures.



Multiple Exposure

Do not remove or replace the memory card while recording a multiple exposure.

Live view (pg. 90) can not be used to record multiple exposures.

The information listed in the playback photo information display (including date of recording and camera orientation) is for the first shot in the multiple exposure.

If no operations are performed for 30 s after the monitor has turned off during playback or menu operations, shooting will end and a multiple exposure will be created from the exposures that have been recorded to that point.

Voice Memos

The camera stores only the last voice memo created during a multiple exposure.

Interval Timer Photography

If interval timer photography is activated before the first exposure is taken, the camera will record exposures at the selected interval until the number of exposures specified in the multiple exposure menu have been taken (the number of shots listed in the interval timer shooting menu is ignored). These exposures will then be recorded as a single photograph and multiple exposure mode and interval timer shooting will end. Cancelling multiple exposure cancels interval timer shooting.

Other Settings

While multiple exposure mode is in effect, memory cards can not be formatted and the following can not be changed: image area, bracketing, and shooting menu options other than [White balance] and [Interval timer shooting] (note that [Interval timer shooting] can only be adjusted before the first exposure is taken). The [Lock mirror up for cleaning] and [Dust off ref photo] options in the setup menu can not be used.



■ Interrupting Multiple Exposures

Selecting [Multiple exposure] in the shooting menu while a multiple exposure is being recorded displays the options shown at right. To interrupt a multiple exposure before the specified number of exposures have been taken, highlight [Cancel] and press **OK**. If shooting ends before the specified number of exposures have been taken, a multiple exposure will be created from the exposures that have been recorded to that point. If [Auto gain] is on, gain will be adjusted to reflect the number of exposures actually recorded. Note that shooting will end automatically if:

- A two-button reset is performed (pg. 204)
- The camera is turned off
- The battery is exhausted
- Pictures are deleted



Interval Timer Photography

The camera is equipped to take photographs automatically at preset intervals.

1 Select [Interval timer shooting].

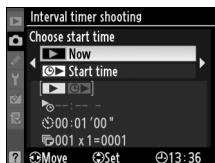
Highlight [Interval timer shooting] in the shooting menu (pg. 290) and press ►.



2 Select a starting trigger.

Highlight one of the following [Choose start time] options and press ►.

- **[Now]:** Shooting begins about 3 s after settings are completed (proceed to Step 4).
- **[Start time]:** Choose a start time (see Step 3).



✓ Before Shooting

Choose single-frame (S), continuous low speed (CL), or continuous high speed (CH) release mode when using the interval timer. Before beginning interval timer photography, take a test shot at current settings and view the results in the monitor. Remember that the camera will focus before each shot—no shots will be taken if the camera is unable to focus in single-servo AF.

Before choosing a starting time, select [World time] in the setup menu and make sure that the camera clock is set to the correct time and date (pg. 40).

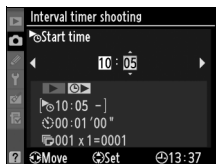
Use of a tripod is recommended. Mount the camera on a tripod before shooting begins.

To ensure that shooting is not interrupted, be sure the battery is fully charged.



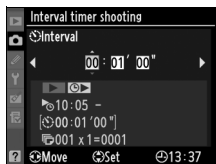
3 Choose a start time.

Press ◀ or ▶ to highlight hours or minutes; press ▲ or ▼ to change. The starting time is not displayed if [Now] is selected for [Choose start time].



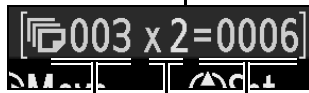
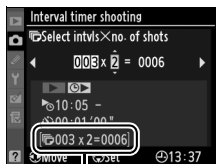
4 Choose an interval.

Press ◀ or ▶ to highlight hours, minutes, or seconds; press ▲ or ▼ to change. Note that the camera will not be able to take photographs at the specified interval if it is shorter than the shutter speed or the time required to record images.



5 Choose the number of intervals and number of shots per interval.

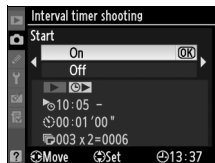
Press ◀ or ▶ to highlight number of intervals or number of shots; press ▲ or ▼ to change. The total number of shots that will be taken is displayed to the right.



Number of intervals Number of shots/interval Total number of shots

6 Start shooting.

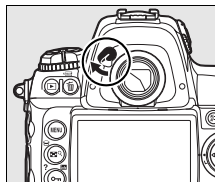
Highlight [Start] > [On] and press **OK** (to return to the shooting menu without starting the interval timer, highlight [Start] > [Off] and press **OK**). The first series of shots will be taken at the specified starting time. Shooting will continue at the selected interval until all shots have been taken.



A message will be displayed in the monitor one minute before each series of shots is taken. If shooting can not proceed at current settings (for example, if a shutter speed of **b** or **L** is currently selected in manual exposure mode or the start time is in less than a minute), a warning will be displayed in the monitor.

The Viewfinder Eyepiece

In exposure modes other than manual, close the viewfinder eyepiece shutter to prevent light entering via the viewfinder from interfering with exposure.



✓ Out of Memory

If the memory card is full, the interval timer will remain active but no pictures will be taken. Resume shooting (pg. 215) after deleting some pictures or turning the camera off and inserting another memory card.

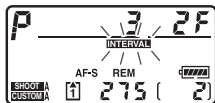
✓ Bracketing

Adjust bracketing settings before starting interval timer photography. If exposure and/or flash bracketing is active while interval timer photography is in effect, the camera will take the number of shots in the bracketing program at each interval, regardless of the number of shots specified in the interval timer menu. If white balance bracketing is active while interval timer photography is in effect, the camera will take one shot at each interval and process it to create the number of copies specified in the bracketing program.

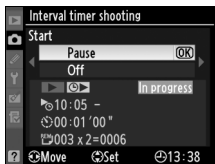
✎ During Shooting

During interval timer photography, the **INTERVAL** icon in the top control panel will blink.

Immediately before the next shooting interval begins, the shutter speed display will show the number of intervals remaining, and the aperture display will show the number of shots remaining in the current interval. At other times, the number of intervals remaining and the number of shots in each interval can be viewed by pressing the shutter-release button halfway (once the button is released, the shutter speed and aperture will be displayed until the exposure meters turn off).



To view current interval timer settings, select [Interval timer shooting] between shots. While interval timer photography is in progress, the interval timer menu will show the starting time, the shooting interval, and the number of intervals and shots remaining. None of these items can be changed while interval timer photography is in progress.



■ ■ Pausing Interval Timer Photography

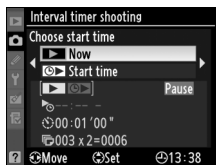
Interval time photography can be paused by:

- Pressing the **ⓧ** button between intervals
- Highlighting [Start] > [Pause] in the interval timer menu and pressing **ⓧ**
- Turning the camera off and then on again (if desired, the memory card can be replaced while the camera is off)
- Selecting live view (**LV**), self-timer (**Ⓢ**), or mirror-up (**MUP**) release modes

To resume shooting:

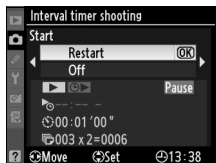
1 Choose a new starting trigger.

Choose a new starting trigger and start time as described on page 211.



2 Resume shooting.

Highlight [Start] > [Restart] and press **ⓧ**. Note that if interval timer photography was paused during shooting, any shots remaining in the current interval will be canceled.



■ ■ *Interrupting Interval Timer Photography*

Interval timer shooting will end automatically if the battery is exhausted. Interval timer photography can also be ended by:

- Selecting [Start] > [Off] in the interval timer menu
- Performing a two button reset (pg. 204)
- Selecting [Reset shooting menu] in the shooting menu (pg. 293)
- Changing bracketing settings (pg. 130)

Normal shooting will resume when interval timer photography ends.

■ ■ *No Photograph*

Photographs will not be taken if the previous photograph is yet to be taken, the memory buffer or memory card is full, or the camera is unable to focus in single-servo AF (note that the camera focuses again before each shot).



✍ **Release Mode**

Regardless of the release mode selected, the camera will take the specified number of shots at each interval. In **C_H** (continuous high speed) mode, photographs will be taken at a rate of five shots per second or, if [DX format (24 × 16)] is selected for [Image area], at the frame rate selected for Custom Setting d2 [Shooting speed] (pg. 321) > [Continuous high-speed]. In **S** (single frame) and **C_L** (continuous low-speed), photographs will be taken at the rate chosen for Custom Setting d2 [Shooting speed] (pg. 321) > [Continuous low-speed].

✍ **Using the Monitor**

Pictures can be played back and shooting and menu settings can be adjusted freely while interval timer photography is in progress. The monitor will turn off automatically about four seconds before each interval.

Shooting Menu Banks

Changes to interval timer settings apply to all shooting menu banks (pg. 291). If shooting menu settings are reset using the [Reset shooting menu] item in the shooting menu (pg. 290), interval timer settings will be reset as follows:

- Choose start time: Now
- Interval: 00:01:00"
- Number of intervals: 1
- Number of shots: 1
- Start shooting: Off



Non-CPU Lenses

By specifying lens data (lens focal length and maximum aperture), the user can gain access to a variety of CPU lens functions when using a non-CPU lens. If the focal length of the lens is known:

- Automatic power zoom can be used with SB-900, SB-800, and SB-600 Speedlights (available separately)
- Lens focal length is listed (with an asterisk) in the playback photo info display

When the maximum aperture of the lens is known:

- The aperture value is displayed in the top control panel and viewfinder
- Flash level is adjusted for changes in aperture
- Aperture is listed (with an asterisk) in the playback photo info display

Specifying both the focal length and maximum aperture of the lens:

- Enables color matrix metering (note that it may be necessary to use center-weighted or spot metering to achieve accurate results with some lenses, including Reflex-Nikkor lenses)
- Improves the precision of center-weighted and spot metering and i-TTL balanced fill-flash for digital SLR



Focal Length Not Listed

If the correct focal length is not listed, choose the closest value greater than the actual focal length of the lens.

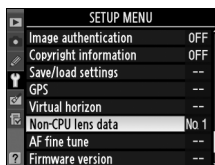
Zoom Lenses

Lens data are not adjusted when non-CPU lenses are zoomed in or out. After changing the zoom position, select new values for lens focal length and maximum aperture.

■ The Non-CPU Lens Data Menu

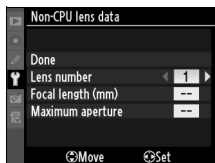
1 Select [Non-CPU lens data].

Highlight [Non-CPU lens data] in the setup menu (pg. 346) and press **▶**.



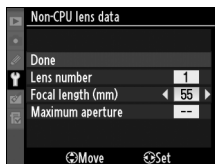
2 Select a lens number.

Highlight [Lens number] and press **◀** or **▶** to choose a lens number between 1 and 9.



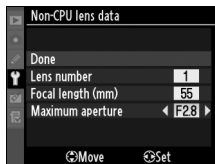
3 Select a focal length.

Highlight [Focal length (mm)] and press **◀** or **▶** to choose a focal length between 6 and 4,000 mm.



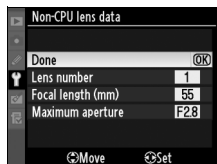
4 Select a maximum aperture.

Highlight [Maximum aperture] and press **◀** or **▶** to choose a maximum aperture between f/1.2 and f/22. The maximum aperture for teleconverters is the combined maximum aperture of the teleconverter and lens.



5 Select [Done].

Highlight [Done] and press **OK**. The specified focal length and aperture will be stored under the chosen lens number. This combination of focal length and aperture can be recalled at any time by selecting the lens number using camera controls as described below.



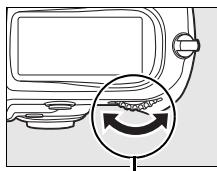
Choosing a Lens Number Using Camera Controls

1 Assign non-CPU lens number selection to a camera control.

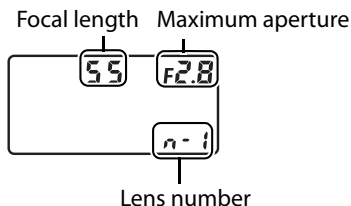
Select [Choose non-CPU lens number] as the “+command dials” option for a camera control in the Custom Settings menu. Non-CPU lens number selection can be assigned to the **Fn** button (Custom Setting f4, [Assign FUNC. button], pg. 333), the depth-of-field preview button (Custom Setting f5, [Assign preview button], pg. 339), or the **AE-L/AF-L** button (Custom Setting f6, [Assign AE-L/AF-L button], pg. 340).

2 Use the selected control to choose a lens number.

Press the selected button and rotate the main command dial until the desired lens number is displayed in the top control panel.



Main command dial



Using a GPS Unit

A GPS unit can be connected to the ten-pin remote terminal, allowing the current latitude, longitude, altitude, Coordinated Universal Time (UTC), and heading to be recorded with each photograph taken. The camera can be used with an optional GP-1 GPS unit (see below; note that the GP-1 does not provide the compass heading), or with third-party units connected via an optional MC-35 GPS adapter cord (pg. 222).

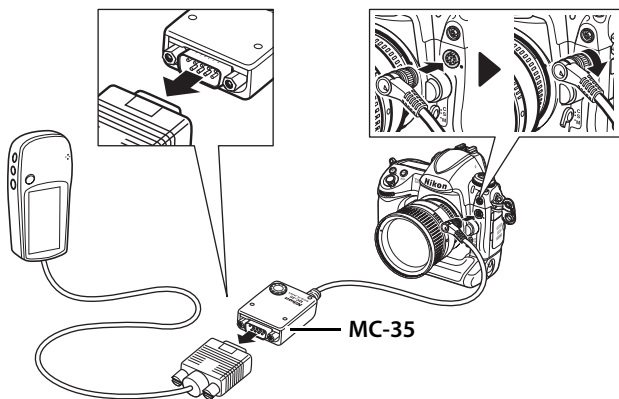
■ ■ *The GP-1 GPS Unit*

The GP-1 is an optional GPS unit designed for use with Nikon digital cameras. For information on connecting the unit, see the manual provided with the GP-1.






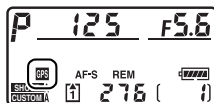
■ ■ Other GPS Units

Optional Garmin GPS units that conform to version 2.01 or 3.01 of the National Marine Electronics Association NMEA0183 data format can be connected to the camera's ten-pin remote terminal using an MC-35 GPS adapter cord (available separately; pg. 393). Operation has been confirmed with Garmin eTrex and Garmin geko series devices equipped with a PC interface cable connector. These devices connect to the MC-35 using a cable with a D-sub 9-pin connector provided by the manufacturer of the GPS device. See the MC-35 instruction manual for details. Before turning the camera on, set the GPS device to NMEA mode (4800 baud).







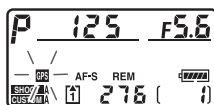
■ The GPS Icon

When the camera establishes communication with a GPS device, a  icon will be displayed in the top control panel. Photo information for pictures taken while the  icon is displayed will include a page of GPS data (pg. 238), including the current latitude, longitude, altitude, Coordinated Universal Time (UTC), and heading (if supported). If no data are received from the GPS unit for two seconds, the  icon will clear from the display and the camera will stop recording GPS information.



GPS Data

GPS data are only recorded when the  icon is displayed. Confirm that the  icon is displayed in the top control panel before shooting. A flashing  icon indicates that the GPS device is searching for a signal; pictures taken while the  icon is flashing will not include GPS data.



■ Setup Menu Options

The [GPS] item in the setup menu contains the options listed below.

- **[Auto meter off]:** Choose whether or not the exposure meters will turn off automatically when a GPS unit is attached.

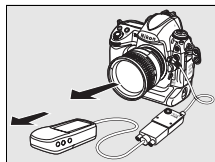
Option	Description
Enable (default)	Exposure meters will turn off automatically if no operations are performed for the period specified in Custom Setting c2 [Auto meter-off delay]. This reduces the drain on the battery but may prevent GPS data from being recorded if the shutter-release button is pressed all the way down without pausing.
Disable	Exposure meters will not turn off while a GPS unit is connected; GPS data will always be recorded.

- **[Position]:** This item is only available if a GPS device is connected, when it displays the current latitude, longitude, altitude, Coordinated Universal Time (UTC), and heading (if supported) as reported by the GPS device.



📷 Heading

The heading is only recorded if the GPS device is equipped with a digital compass (note that the GP-1 is not equipped with a compass). Keep the GPS device pointing in the same direction as the lens and at least 20 cm (8 in.) from the camera.



📷 Coordinated Universal Time (UTC)

UTC data is provided by the GPS device and is independent of the camera clock.



More About Playback


– *Playback Options*

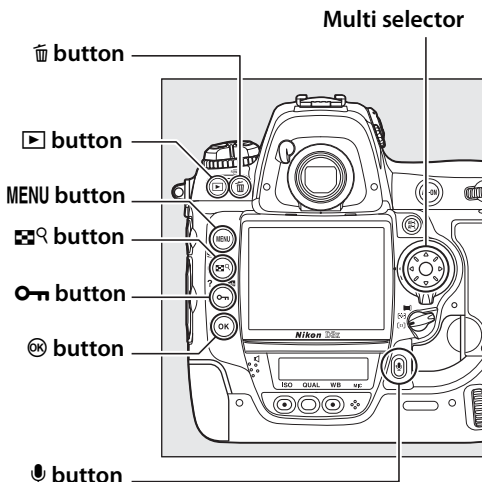
This chapter describes how to play back photographs and details the operations that can be performed during playback.

Full-Frame Playback.....	pg. 226
Photo Information	pg. 229
Viewing Multiple Images: Thumbnail Playback	pg. 241
Taking a Closer Look: Playback Zoom	pg. 243
Protecting Photographs from Deletion	pg. 244
Deleting Individual Photographs.....	pg. 245

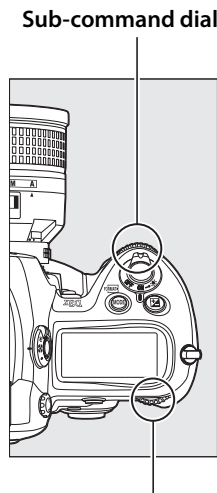


Full-Frame Playback

To play photographs back, press the  button. The most recent photograph will be displayed in the monitor.



Multi selector



Sub-command dial

Main command dial

Rotate Tall

To display “tall” (portrait-orientation) photographs in tall orientation, select [On] for the [Rotate tall] option in the playback menu (pg. 287). Note that because the camera itself is already in the appropriate orientation during shooting, images are not rotated automatically during image review (pg. 228).






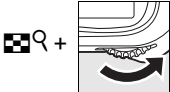












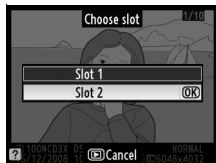
To	Use	Description
View additional photographs		Press ► to view photographs in order recorded, ◀ to view photographs in reverse order.
View photo information		Press ▲ or ▼ to view information about current photograph (pg. 229).
View thumbnails		See page 241 for more information on the thumbnail display.
Zoom in on photograph		See page 243 for more information on playback zoom.
Delete images		Confirmation dialog will be displayed. Press  again to delete photo (pg. 245).
Record/play voice memo		If voice memo has not been recorded, voice memo will be recorded while  button is pressed. If voice memo has been recorded, pressing  button will start playback (pg. 248).
Change protect status		To protect image, or to remove protection from protected image, press  button (pg. 244).
View images on other memory card		If two memory cards are inserted, choose memory card from which pictures are played back (pg. 228).
Return to shooting mode		Monitor will turn off. Photographs can be taken immediately.
Display menus	MENU	See page 277 for more information.

Image Review

When [On] is selected for [Image review] in the playback menu (pg. 287), photographs are automatically displayed in the monitor for about 20 s (the default setting) after shooting (because the camera is already in the correct orientation, images are not rotated automatically during image review). In single-frame, self-timer, and mirror-up release modes, photographs are displayed one at a time as they are taken. In continuous release mode, display begins when shooting ends, with the first photograph in the current series displayed.

Two Memory Cards

If two memory cards are inserted, holding the  button and pressing  in full-frame or thumbnail playback will display the menu shown at right. Highlight the desired slot and press . The same method can be used to choose a slot when selecting images for operations in the playback (pg. 278) or retouch menus (pg. 363) or when choosing an image as the source for preset white balance (pg. 156).



See Also

For information on choosing how long the monitor will remain on when no operations are performed, see Custom Setting c4 [Monitor off delay] (pg. 319).





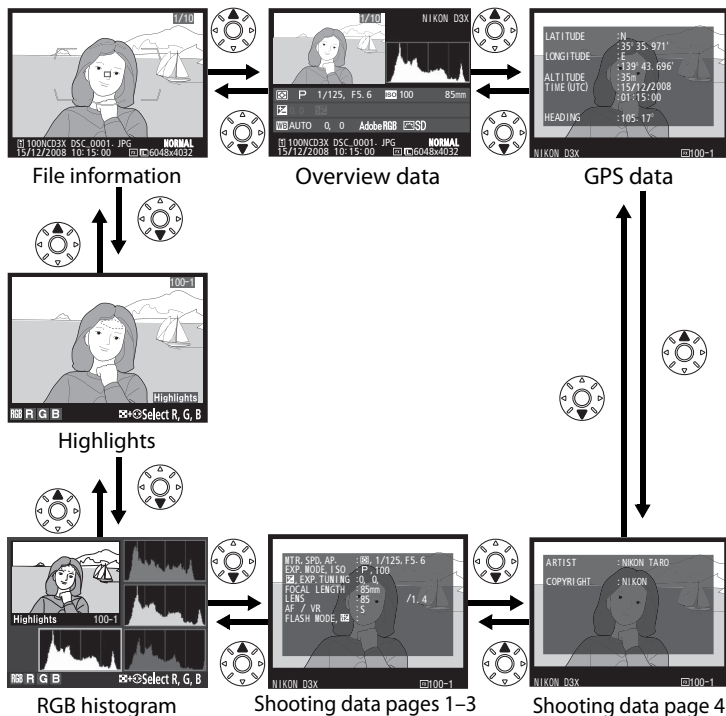
The roles of the multi selector buttons can be reversed, so that the  and  buttons display other images and the  and  buttons control photo information. See Custom Setting f3 [Photo info/playback] (pg. 332) for details.

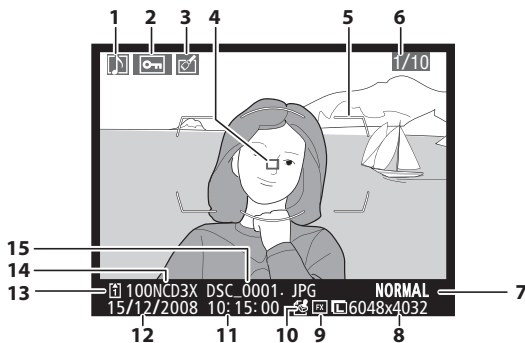


Photo Information

Photo information is superimposed on images displayed in full-frame playback. There are up to 9 pages of information for each photo. Press ▲ or ▼ to cycle through photo information as shown below. Note that shooting data, RGB histograms, and highlights are only displayed if corresponding option is selected for [Display mode] (pg. 282; shooting data page 4 is only displayed if copyright information was recorded with the photograph as described on page 357). GPS data are only displayed if a GPS device was used when the photo was taken.



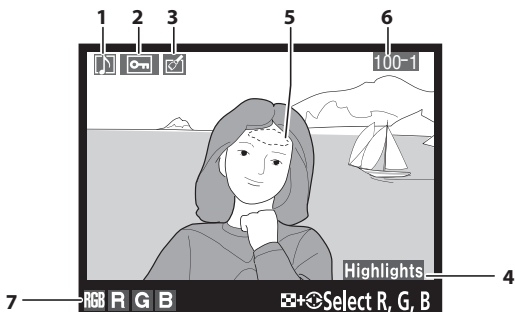
File Information



1 Voice memo icon	248	8 Image size	70
2 Protect status	244	9 Image area ²	60
3 Retouch indicator	363	10 Image authentication	356
4 Focus point ¹	282	11 Time of recording	40
5 AF area brackets	47, 92	12 Date of recording	40
6 Frame number/ total number of frames		13 Slot number	42
7 Image quality	66	14 Folder name	293
		15 File name	296

- 1 Displayed only if [Focus point] is selected for [Display mode] (pg. 282).
- 2 Displayed in yellow if [DX format (24 × 16)] or [5 : 4 (30 × 24)] was selected for the [Image area] option (pg. 60) in the shooting menu.

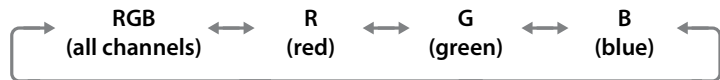
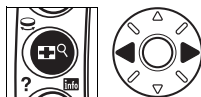
■ Highlights¹



1 Voice memo icon 248	5 Image highlights ² 282
2 Protect status 244	6 Folder number-frame number ³ 293
3 Retouch indicator 363	7 Current channel ²
4 Highlight display indicator... 282	

1 Displayed only if [Highlights] is selected for [Display mode] (pg. 282).

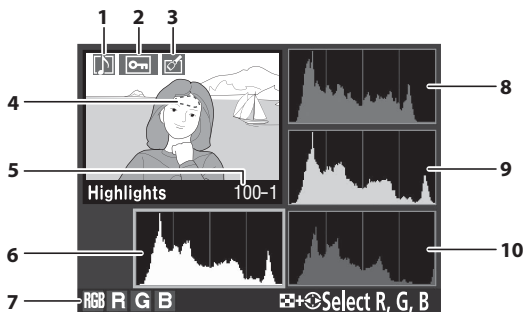
2 Blinking areas indicate highlights (areas that may be overexposed) for current channel. Press ◀ or ▶ while pressing button to cycle through channels as follows:



3 Displayed in yellow if [DX format (24 × 16)] () or [5 : 4 (30 × 24)] () was selected for the [Image area] option (pg. 60) in the shooting menu.



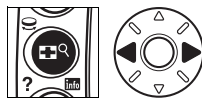
RGB Histogram ¹



- | | |
|--|--|
| <p>1 Voice memo icon 248</p> <p>2 Protect status 244</p> <p>3 Retouch indicator 363</p> <p>4 Image highlights ² 282</p> <p>5 Folder number–frame number ³ 293</p> | <p>6 Histogram (RGB channel) ⁴. In all histograms, horizontal axis gives pixel brightness, vertical axis number of pixels.</p> <p>7 Current channel ²</p> <p>8 Histogram (red channel) ⁴</p> <p>9 Histogram (green channel) ⁴</p> <p>10 Histogram (blue channel) ⁴</p> |
|--|--|

1 Displayed only if [RGB histogram] is selected for [Display mode] (pg. 282).

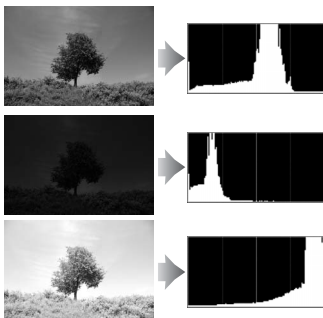
2 Blinking areas indicate highlights (areas that may be overexposed) for current channel. Press ◀ or ▶ while pressing button to cycle through channels as follows:



3 Displayed in yellow if [DX format (24 × 16)] () or [5 : 4 (30 × 24)] () was selected for the [Image area] option (pg. 60) in the shooting menu.

4 Some sample histograms are shown below:

- If the image contains objects with a wide range of brightnesses, the distribution of tones will be relatively even.
- If the image is dark, tone distribution will be shifted to the left.
- If the image is bright, tone distribution will be shifted to the right.

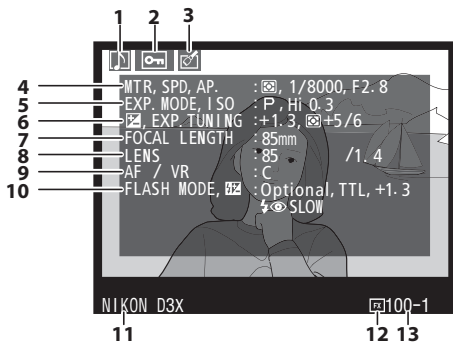


Increasing exposure compensation shifts the distribution of tones to the right, while decreasing exposure compensation shifts the distribution to the left. Histograms can provide a rough idea of overall exposure when bright ambient lighting makes it difficult to see photographs in the monitor.



Histograms

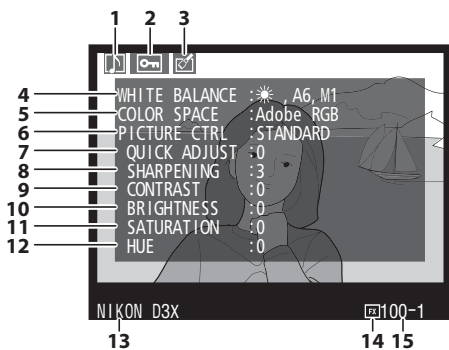
Camera histograms are intended as a guide only and may differ from those displayed in imaging applications.



1 Voice memo icon	248	8 Lens data	218
2 Protect status	244	9 Focus mode	74
3 Retouch indicator	363	Lens VR	
4 Metering method	110	(vibration reduction) ⁴	382
Shutter speed	116, 120	10 Flash mode	194
Aperture	118, 120	Flash compensation	
5 Exposure mode	112	Commander mode ⁵	
ISO sensitivity ²	104	11 Camera name	
6 Exposure compensation	128	12 Image area ⁶	60
Optimal exposure tuning ³ ...	316	13 Folder number–frame	
7 Focal length	386	number ⁶	293



- 1 Displayed only if [Data] is selected for [Display mode] (pg. 282).
- 2 Displayed in red if photo was taken with ISO sensitivity auto control on.
- 3 Displayed if Custom Setting b6 ([Fine tune optimal exposure]) has been set to a value other than zero for any metering method.
- 4 Displayed only if VR lens is attached.
- 5 Displayed only if optional flash unit SB-900, SB-800, SB-600, or SB-R200 is used.
- 6 Displayed in yellow if [DX format (24 × 16)] or [5 : 4 (30 × 24)] was selected for the [Image area] option (pg. 60) in the shooting menu.

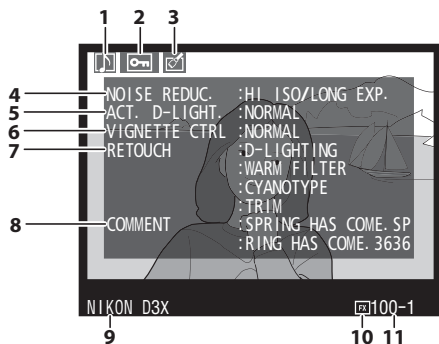


1 Voice memo icon	248	8 Sharpening	167
2 Protect status	244	9 Contrast	167
3 Retouch indicator	363	10 Brightness	167
4 White balance	140	11 Saturation ⁴	167
Color temperature	147	Filter effects ⁵	167
White balance fine-tuning ...	143	12 Hue ⁴	167
Preset manual	148	Toning ⁵	167
5 Color space	183	13 Camera name	
6 Picture Control	162	14 Image area ⁶	60
7 Quick adjust ²	167	15 Folder number-frame	
Original Picture Control ³	173	number ⁶	293

- 1 Displayed only if [Data] is selected for [Display mode] (pg. 282).
- 2 [Standard] and [Vivid] Picture Controls only.
- 3 [Neutral], [Monochrome], and custom Picture Controls.
- 4 Not displayed with monochrome Picture Controls.
- 5 Monochrome Picture Controls only.
- 6 Displayed in yellow if [DX format (24 × 16)] or [5 : 4 (30 × 24)] was selected for the [Image area] option (pg. 60) in the shooting menu.



■ Shooting Data Page 3¹

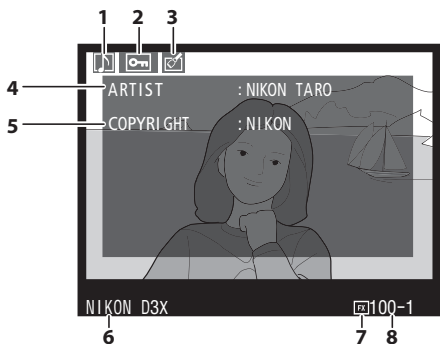


1 Voice memo icon	248	6 Vignette control.....	299
2 Protect status	244	7 Retouch history.....	363
3 Retouch indicator	363	8 Image comment	350
4 High ISO noise reduction.....	300	9 Camera name	
Long exposure noise		10 Image area ²	60
reduction	300	11 Folder number-frame	
5 Active D-Lighting.....	181	number ²	293

- 1 Displayed only if [Data] is selected for [Display mode] (pg. 282).
 2 Displayed in yellow if [DX format (24 × 16)] or [5 : 4 (30 × 24)] was selected for the [Image area] option (pg. 60) in the shooting menu.



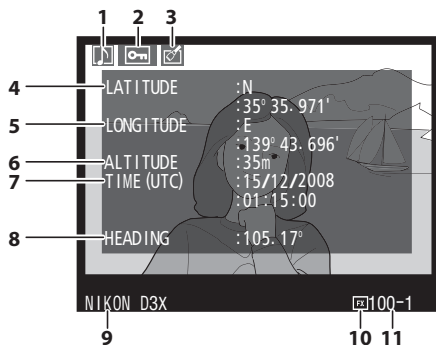
Shooting Data Page 4¹



1 Voice memo icon	248	6 Camera name	
2 Protect status	244	7 Image area ²	60
3 Retouch indicator	363	8 Folder number-frame	
4 Name of photographer.....	357	number ²	293
5 Copyright holder.....	357		

- 1 Displayed only if [Data] is selected for [Display mode] (pg. 282) and copyright information was appended to photograph (pg. 357).
- 2 Displayed in yellow if [DX format (24 × 16)] or [5 : 4 (30 × 24)] was selected for the [Image area] option (pg. 60) in the shooting menu.



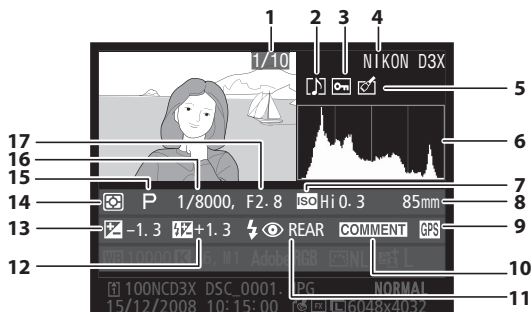


- | | |
|--|---|
| <p>1 Voice memo icon 248</p> <p>2 Protect status 244</p> <p>3 Retouch indicator 363</p> <p>4 Latitude</p> <p>5 Longitude</p> <p>6 Altitude</p> | <p>7 Coordinated Universal Time (UTC)</p> <p>8 Heading²</p> <p>9 Camera name</p> <p>10 Image area³ 60</p> <p>11 Folder number-frame number³ 293</p> |
|--|---|

- 1 Displayed only if GPS device was used when photo was taken (pg. 221).
- 2 Displayed only if GPS device is equipped with electronic compass.
- 3 Displayed in yellow if [DX format (24 × 16)] or [5 : 4 (30 × 24)] was selected for the [Image area] option (pg. 60) in the shooting menu.



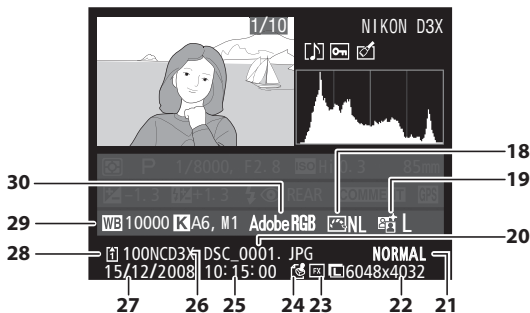
Overview Data



1 Frame number/ total number of frames	7 ISO sensitivity ¹ 104
2 Voice memo icon 248	8 Focal length 386
3 Protect status 244	9 GPS data indicator 221
4 Camera name	10 Image comment indicator 350
5 Retouch indicator 363	11 Flash mode 194
6 Histogram showing the distribution of tones in the image (pg. 233). Horizontal axis corresponds to pixel brightness, vertical axis shows number of pixels of each brightness in image.	12 Flash compensation
	13 Exposure compensation 128
	14 Metering method 110
	15 Exposure mode 112
	16 Shutter speed 116, 120
	17 Aperture 118, 120

1 Displayed in red if photo was taken with ISO sensitivity auto control on.






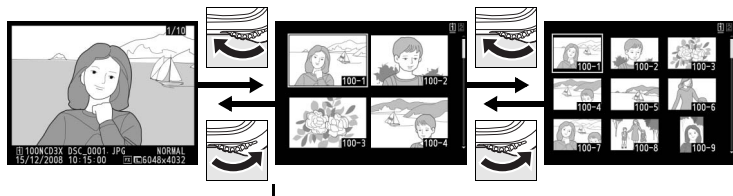
18 Picture Control	162	26 Folder name	293
19 Active D-Lighting	181	27 Date of recording	40
20 File name	296	28 Slot number	42
21 Image quality	66	29 White balance	140
22 Image size	70	Color temperature	147
23 Image area ²	60	White balance fine-tuning	143
24 Image authentication indicator	356	Preset manual	148
25 Time of recording	40	30 Color space	183

2 Displayed in yellow if [DX format (24 × 16)] or [5 : 4 (30 × 24)] was selected for the [Image area] option (pg. 60) in the shooting menu.



Viewing Multiple Images: Thumbnail Playback

To display images in “contact sheets” of four or nine images, press the  button and rotate the main command dial.











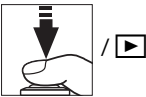


Full-frame playback

Thumbnail playback




The following operations can be performed while thumbnails are displayed:

To	Use	Description
Change number of images displayed		Press  button and rotate main command to left to display one, four, or nine images per page.
Toggle full frame playback		Press center of multi selector to switch back and forth between full frame and thumbnail playback.
Highlight images		Use multi selector to highlight images for full-frame playback, playback zoom (pg. 243), or deletion (pg. 245).
Page through images		Press  button and rotate sub-command dial to scroll through images a page at a time.
Delete highlighted photo		See page 245 for more information.
Record/play voice memo		See page 248 for more information.
Change protect status of highlighted photo		See page 244 for more information.
View images on other memory card		If two memory cards are inserted, choose memory card from which pictures are played back (pg. 228).
Return to shooting mode		Monitor will turn off. Photographs can be taken immediately.
Display menus	MENU	See page 277 for more information.













See Also

For information on choosing the role played by the center of the multi selector, see Custom Setting f1 [Multi selector center button] (pg. 331).

Taking a Closer Look: Playback Zoom



Press the  button and rotate the main command dial right to zoom in on the image displayed in full-frame playback or on the image currently highlighted in thumbnail playback.

The following operations can be performed while zoom is in effect:

To	Use	Description
Zoom in or out	 + 	Press  button to display frame showing area currently zoomed in. While  button is pressed, main command dial can be used to control size of frame—rotate dial left to zoom out, right to zoom in.  rotate dial left to zoom out, right to zoom in. 36×24 (3 : 2) format images in up to $27 \times$ (large images), $20 \times$ (medium images) or $13 \times$ (small images). Release  button to magnify selected area to fill monitor.
View other areas of image	 + 	Use multi selector to view area not visible in monitor. Keep multi selector pressed to scroll rapidly to other areas of frame.
View other images		Rotate main command dial to view same location in other images at current zoom ratio.
Change protect status		See page 244 for more information.
Return to shooting mode	 / 	Monitor will turn off. Photographs can be taken immediately.
Display menus	MENU	See page 277 for more information.



Protecting Photographs from Deletion



In full-frame, zoom, and thumbnail playback, the  button can be used to protect photographs from accidental deletion. Protected files can not be deleted using the  button or the [Delete] option in the playback menu. Note that protected images *will* be deleted when the memory card is formatted (pp. 45, 347). To protect a photograph:

1 Select an image.

Display the image in full-frame playback or playback zoom or highlight it in the thumbnail list.



2 Press the button.



The photograph will be marked with a  icon. To remove protection from the photograph so that it can be deleted, display the photograph or highlight it in the thumbnail list and then press the  button.




Voice Memos

Changes to the protect status of images also apply to any voice memos that may have been recorded with the images. Voice memo overwrite status can not be set separately.

Removing Protection from All Images

To remove protection from all images in the folder or folders currently selected in the [Playback folder] menu, press the  and  buttons together for about two seconds.

Deleting Individual Photographs

To delete the photograph displayed in full-frame playback or the photograph highlighted in the thumbnail list, press the  button. Once deleted, photographs can not be recovered.

1 Select an image.

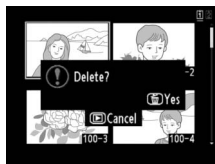
Display the image or highlight it in the thumbnail list.

2 Press the button.



A confirmation dialog will be displayed.



Full-frame playback






Thumbnail playback


To delete the photograph, press the  button again. To exit without deleting the photograph, press the  button.



Voice Memos

If a voice memo has been recorded with the selected image, the confirmation dialog shown at right will be displayed when the  button is pressed.

- **[Image/sound]:** Select this option and press the  button to delete both photo and voice memo.
- **[Sound only]:** Select this option and press the  button to delete only the voice memo.

To exit without deleting either voice memo or photo, press .



See Also

To delete multiple images, use the [Delete] option in the playback menu (pg. 281). The [After delete] option in the playback menu determines whether the next image or the previous image is displayed after an image is deleted (pg. 287).





Voice Memos

– *Recording and Playback*

The camera is equipped with a built-in microphone, allowing voice memos to be added to photographs. Voice memos can be played back over the camera's built-in speaker.

Recording Voice Memos pg. 248

Playing Voice Memos..... pg. 253



Recording Voice Memos

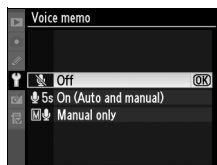
Voice memos up to sixty seconds long can be added to photographs using the built-in microphone.






Readying the Camera for Recording

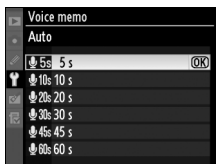
Before recording voice memos, choose the desired options for the [Voice memo] (pg. 248), [Voice memo overwrite] (pg. 249), and [Voice memo button] (pg. 249) options in the setup menu.

■ ■ Voice Memo

This option controls whether voice memos are recorded automatically or manually. The following options are available:

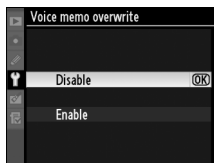


Option	Description
 Off (default)	Voice memos can not be recorded in shooting mode.
 On (Auto and manual)	Selecting this option displays menu shown at right; select maximum recording time from 5 (default), 10, 20, 30, 45, or 60 s. Unless [On] is selected for [Image review] in playback menu (pg. 287), recording will begin when shutter-release button is released after shooting. Recording ends when  button is pressed or after specified recording time has ended.
 Manual only	Memo can be recorded for most recent photograph by pressing and holding  button (pg. 250).



■ Voice Memo Overwrite

This option controls whether the voice memo for the most recent photograph can be overwritten in shooting mode. The following options are available:








Option	Description
Disable (default)	Voice memo can not be recorded in shooting mode if one already exists for most recent image.
Enable	Voice memo can be recorded in shooting mode even if one already exists for most recent image (pg. 250). Existing memo will be deleted and replaced by new memo.

■ Voice Memo Button

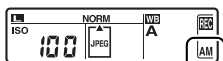
This option controls manual recording. The following options are available:



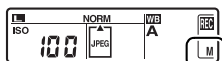
Option	Description
 Press and hold (default)	Voice memo is recorded while  button is held down. Recording will end automatically after 60 s.
 Press to start/stop	Recording begins when  button is pressed and ends when  button is pressed again. Recording will end automatically after 60 s.

■ Voice Memo

The option selected for [Voice memo] is indicated by an icon in the rear control panel.




On (auto and manual)





Manual only

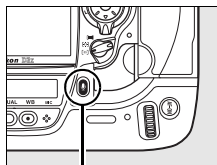


Automatic Recording (Shooting Mode)

If [On (Auto and manual)] is selected for [Voice memo] (pg. 248), a voice memo will be added to the most recent photograph when shooting ends. Recording will end when the  button is pressed or after the specified recording time has ended.


Manual Recording (Shooting Mode)

If [On (Auto and manual)] or [Manual only] is selected for [Voice memo] (pg. 248), a voice memo can be recorded for the most recent photograph by pressing and holding the  button. A voice memo will be recorded while the button is held down (note that no voice memo will be recorded if the  button is not held down for at least one second).



 button

Automatic Recording

 Voice memos will not be recorded automatically if [On] is selected for the [Image review] option (pg. 287) in the playback menu. A voice memo can however be added to the photograph displayed during image review even if [Off] is selected for the [Voice memo] option in the setup menu.


Slot 2

If two memory cards are inserted and [Backup] or [RAW Slot 1-JPEG Slot 2] is selected for the [Slot 2] option (pg. 72) in the shooting menu, voice memos will be associated with the images recorded to the memory card in slot 1.

Playback Mode



To add a voice memo to the photograph currently displayed in full-frame playback or highlighted in the thumbnail list (pg. 226):

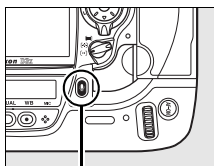
1 Choose a photograph.

Display or highlight the photograph. Only one voice memo can be recorded per image; additional voice memos can not be recorded for images already marked with a  icon.




2 Press and hold the button.

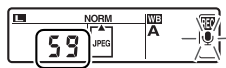
A voice memo will be recorded while the  button is held down (note that no voice memo will be recorded if the  button is not held down for at least one second).



 button

During Recording

During recording, the  icons in the rear control panel will blink. A countdown timer in the rear control panel shows the length of the voice memo that can be recorded (in seconds).




Rear control panel

In playback mode, a  icon is displayed in the monitor during recording.




Interrupting Recording

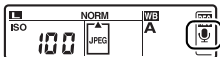
Recording will end automatically if:

- The **MENU** button is pressed to display the menus
- The  button is pressed
- The shutter-release button is pressed halfway
- The camera is turned off


During interval timer photography, recording will end automatically about two seconds before the next photograph is taken.

After Recording

If a voice memo has been recorded for the most recent photograph, a  icon will be displayed in the rear control panel.



Rear control panel

If a voice memo exists for the photograph currently selected in playback mode, a  icon will be displayed in the monitor.




Voice Memo File Names









Voice memos are stored as WAV files with names of the form “xxxxnnnn.WAV,” where “xxxxnnnn” is a file name copied from the image with which the voice memo is associated. For example, the voice memo for the image “DSC_0002.JPG” would have the file name “DSC_0002.WAV.” Voice memo file names can be viewed on a computer.

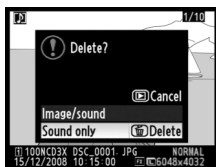


Playing Voice Memos

Voice memos can be played back over the camera's built-in speaker when the associated image is viewed in full-frame playback or highlighted in the thumbnail list (pp. 226, 242). The presence of a voice memo is indicated by an  icon.




To	Press	Description
Start/end playback		Press  to start playback. Playback will end when  button is pressed again or entire memo has been played back.
Delete voice memo		Confirmation dialog will be displayed. Press  or  to highlight option, press  to select. <ul style="list-style-type: none">• [Image/sound]: Delete both photo and voice memo.• [Sound only]: Delete voice memo only. To exit without deleting image or voice memo, press the  button.



Interrupting Playback

Playback will end automatically if:

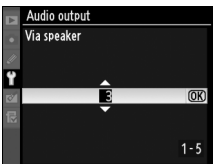
- The **MENU** button is pressed to display the menus
- The monitor is turned off by pressing the  button or by pressing the shutter-release button halfway
- The camera is turned off
- Another image is selected



Voice Memo Playback Options

The [Audio output] option in the setup menu controls whether voice memos are played back over the camera's built-in speaker or by a device to which the camera is connected via an HDMI or audio/video cable. When sound is played back over the built-in speaker, the [Audio output] option also controls playback volume.



	Option	Description
🔊	Via speaker (default)	Voice memos are played back over built-in speaker. Selecting this option displays menu shown at right. Press ▲ or ▼ to change volume. Beep will sound when option is selected. Press Ⓞ to make selection and return to setup menu. 
A/V-OUT	HDMI/audio-video output	Audio signal output to HDMI or A/V-OUT terminal.
🔇	Off	Voice memos are not played back. 🔇 icon is displayed when photo for which voice memo exists is viewed in monitor.





Connections

– *Connecting to External Devices*

This chapter describes how to copy photographs to a computer, how to print pictures, and how to view them on a television set.


Connecting to a Computer	pg. 256
Direct USB Connection	pg. 258
Wireless and Ethernet Networks	pg. 261
Printing Photographs	pg. 262
Direct USB Connection	pg. 263
Viewing Photographs on TV	pg. 274
Standard Definition Devices	pg. 274
High-Definition Devices	pg. 276



Connecting to a Computer

This section describes how to connect the camera to a computer using the supplied UC-E4 USB cable. Once the camera is connected, Nikon Transfer (supplied) or optional Nikon software such as Camera Control Pro 2 can be used to copy photographs to the computer or control the camera remotely.

Connecting Cables

 Be sure the camera is off when connecting or disconnecting interface cables. Do not use force or attempt to insert the connectors at an angle.

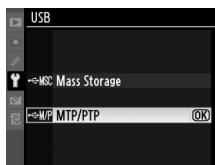
Camera Control Pro 2

Camera Control Pro 2 (available separately; pg. 391) can be used to control the camera from a computer. Before connecting the camera, set the camera [USB] option (pg. 257) to [MTP/PTP]. When Camera Control Pro 2 is running, “**P**” will be displayed in the top control panel.

■ ■ Before Connecting the Camera

Install the necessary software from the supplied installer CD (see the *Install Guide* for more information). To ensure that data transfer is not interrupted, be sure the camera battery is fully charged. If in doubt, charge the battery before use or use an EH-6 AC adapter (available separately).

Before connecting the camera, select the [USB] option in the camera setup menu (pg. 352) and choose a USB option from [MTP/PTP] (default) and [Mass Storage] as described below.



Operating system *	Nikon Transfer	Camera Control Pro 2
<ul style="list-style-type: none">• Windows Vista Service Pack 1 (32-bit Home Basic/Home Premium/Business/Enterprise/Ultimate editions)• Windows XP Service Pack 3 (Home Edition/Professional)	Choose [MTP/PTP] or [Mass Storage]	Choose [MTP/PTP]
Mac OS X (version 10.3.9, 10.4.11, or 10.5.5)		

* See the websites listed on page xxiv for the latest information on supported operating systems.



Direct USB Connection

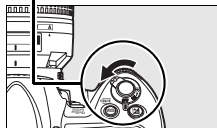
Connect the camera using the supplied UC-E4 USB cable.

1 Select a USB option.

Before connecting the camera to the computer, make sure the correct option is selected for the [USB] item in the camera setup menu (pg. 257).

2 Turn the camera off.

Power switch

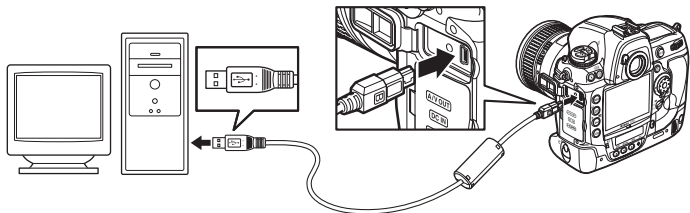


3 Turn the computer on.

Turn the computer on and wait for it to start up.

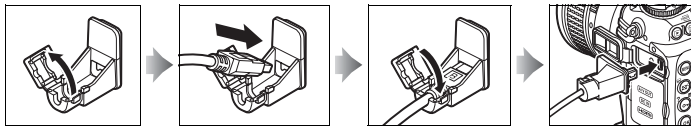
4 Connect the USB cable.

Connect the USB cable as shown. Do not use force or attempt to insert the connectors at an angle.



✔ The USB Cable Clip

To prevent cable from being disconnected, fasten the clip as shown.



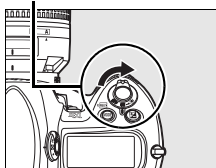
✔ USB Hubs

Connect the camera directly to the computer; do not connect the cable via a USB hub or keyboard.

5 Turn the camera on.

If [Mass Storage] is selected for [USB] (pg. 257), **PC** will be displayed in the control panels and viewfinder, and the PC connection indicator will flash in the top control panel (camera displays do not change if [MTP/PTP] is selected).

Power switch



6 Transfer photographs.

Transfer photographs to the computer as described in the online help for Nikon Transfer. To view the online help, start Nikon Transfer and select [Nikon Transfer help] from the Nikon Transfer [Help] menu.

✔ During Transfer


Do not turn the camera off or disconnect the USB cable while transfer is in progress.

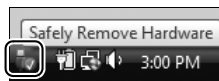


7 Turn the camera off.


If [MTP/PTP] is selected for [USB], the camera can be turned off and the USB cable disconnected once transfer is complete. If [Mass Storage] is selected, the camera must first be removed from the system as described below.

Windows Vista

Click the “Safely Remove Hardware” icon () in the taskbar and select [Safely Remove USB Mass Storage Device] from the menu that appears.



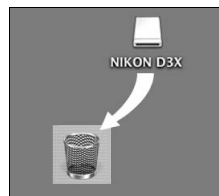
Windows XP Home Edition / Windows XP Professional

Click the “Safely Remove Hardware” icon () in the taskbar and select [Safely remove USB Mass Storage Device] from the menu that appears.



Mac OS X

Drag the camera volume (“NIKON D3X”) into the Trash.



Wireless and Ethernet Networks

If the optional WT-4 wireless transmitter is attached, photographs can be transferred or printed over wireless or Ethernet networks and the camera can also be controlled from network computers running Camera Control Pro 2 (available separately). The WT-4 can be used in any of the following modes:

Mode	Function
Transfer mode	Upload new or existing photographs to computer or ftp server.
Thumbnail select mode	Preview photographs on computer monitor before upload.
PC mode	Control camera from computer using Camera Control Pro 2 (available separately).
Print mode	Print JPEG photographs on printer connected to network computer.

For more information, see the WT-4 user's manual. Be sure to update to the latest versions of the WT-4 firmware and supplied software.

USB

Select [MTP/PTP] for the camera [USB] option (pg. 257) before connecting a WT-4 wireless transmitter.

WT-4A/B/C/D/E

The principal difference between the WT-4 and WT-4A/B/C/D/E is in the number of channels supported; unless otherwise stated, all references to the WT-4 also apply to the WT-4A/B/C/D/E.



Printing Photographs

Photographs can be printed by any of the following methods:

- Connect the camera to a printer and print JPEG photographs directly from the camera (pg. 263).
- Insert the camera memory card in a printer equipped with a card slot (see the printer manual for details). If the printer supports DPOF (pg. 440), photographs can be selected for printing using [Print set (DPOF)] (pg. 272).
- Take the camera memory card to a developer or digital printer center. If the center supports DPOF (pg. 440), photographs can be selected for printing using [Print set (DPOF)] (pg. 272).
- Print JPEG photographs on a printer connected to a network computer using the WT-4 wireless transmitter (available separately; see the WT-4 user's manual for details).
- Transfer pictures (pg. 256) and print them from a computer using ViewNX (supplied) or Capture NX 2 (available separately; pg. 391). Note that this is the only method available for printing RAW (NEF) pictures.

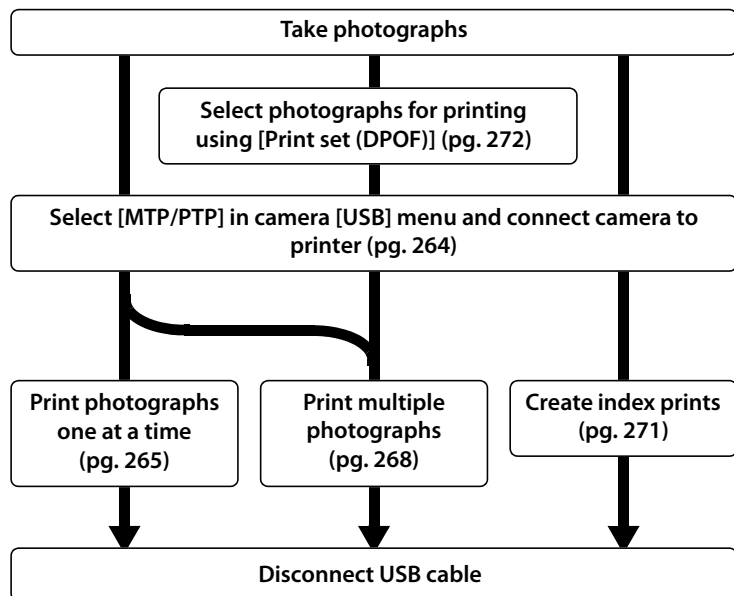


TIFF Photographs

TIFF photographs can be printed from a computer. Some digital print services may also support TIFF; check with the service before ordering.

Direct USB Connection

If the camera is connected to a PictBridge printer via the supplied USB cable, selected JPEG pictures can be printed directly from the camera.



✔ USB Hubs

Connect the camera directly to the computer; do not connect the cable via a USB hub or keyboard.

✎ Printing Via Direct USB Connection

Be sure the battery is fully charged or use an optional EH-6 AC adapter. When taking photographs to be printed via direct USB connection, set [Color space] to [sRGB] (pg. 183).

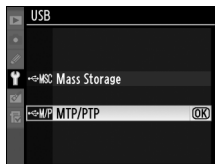


■ Connecting the Printer

Connect the camera using the supplied UC-E4 USB cable.

1 Select [MTP/PTP].

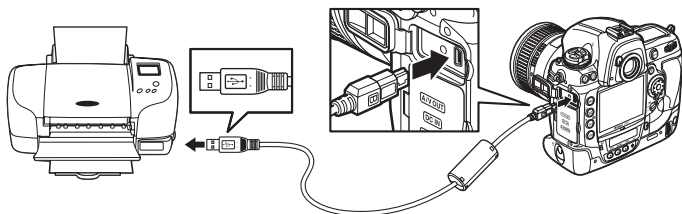
If the [USB] option in the camera setup menu has been changed from the default setting of [MTP/PTP], display the [USB] menu and select [MTP/PTP] (pg. 257).



2 Turn the camera off.

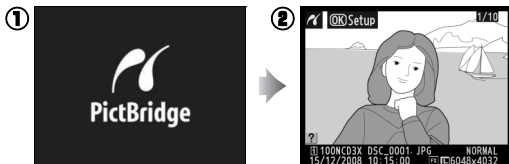
3 Connect the USB cable.

Turn the printer on and connect the USB cable as shown. Do not use force or attempt to insert the connectors at an angle.




4 Turn the camera on.

A welcome screen will be displayed in the monitor, followed by a PictBridge playback display.




■ ■ Printing Pictures One at a Time


1 Select a picture.

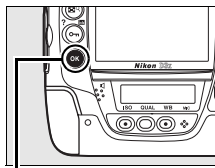
Press ◀ or ▶ to view additional pictures, or press the  button and rotate the main command dial right to zoom in on the current frame (pg. 243).



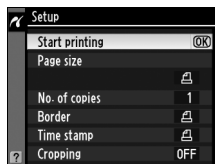
Press  to return to full-frame playback. To view six pictures at a time, press the center of the multi selector. Use the multi selector to highlight pictures, or press the center of the multi selector again to display the highlighted picture full frame.

2 Display printing options.

Press  to display PictBridge printing options.

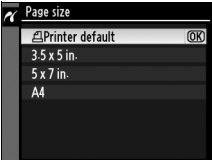
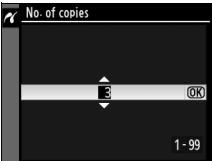
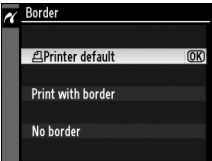
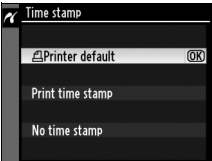


 **button**

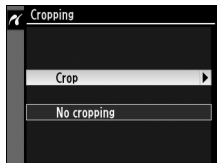


3 Adjust printing options.

Press ▲ or ▼ to highlight an option and press ► to select.

Option	Description
Page size	<p>Menu shown at right will be displayed. Press ▲ or ▼ to choose page size (to print at default page size for current printer, select [Printer default]), then press Ⓚ to select and return to previous menu.</p> 
No. of copies	<p>Menu shown at right will be displayed. Press ▲ or ▼ to choose number of copies (maximum 99), then press Ⓚ to select and return to previous menu.</p> 
Border	<p>Menu shown at right will be displayed. Press ▲ or ▼ to choose print style from [Printer default] (default for current printer), [Print with border] (print photo with white border), or [No border], then press Ⓚ to select and return to previous menu.</p> 
Time stamp	<p>Menu shown at right will be displayed. Press ▲ or ▼ to choose [Printer default] (default for current printer), [Print time stamp] (print time and date of recording on photo), or [No time stamp], then press Ⓚ to select and return to previous menu.</p> 

Option	Description
<p>Cropping</p>	<p>Menu shown at right will be displayed. To exit without cropping picture, highlight [No cropping] and press OK. To crop picture, highlight [Crop] and press ▶.</p> <p>If [Crop] is selected, dialog shown at right will be displayed. Rotate main command dial to right to increase size of crop, left to decrease. Choose position of crop using multi selector and press OK.</p>



4 Start printing.

Select [Start printing] and press **OK** to start printing. To cancel before all copies have been printed, press **OK**.



✓ Selecting Photographs for Printing

Images created at image quality settings of NEF (RAW) or TIFF (RGB) (pg. 66) can not be selected for printing.

✎ See Also

See page 420 for information on what to do if an error occurs during printing.



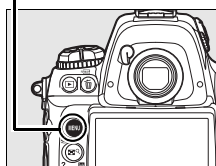
Printing Multiple Pictures

1 Display the PictBridge menu.

Press the **MENU** button in the PictBridge playback display (see Step 4 on page 264).



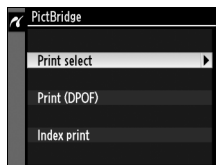
MENU button



2 Choose [Print select] or [Print (DPOF)].

Highlight one of the following options and press ►.









- **[Print select]**: Select pictures for printing.
- **[Print (DPOF)]**: Print an existing print order created with the [Print set (DPOF)] option in the playback menu (pg. 272).
The current print order will be displayed in Step 3.

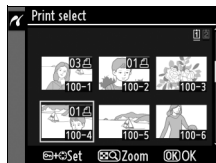
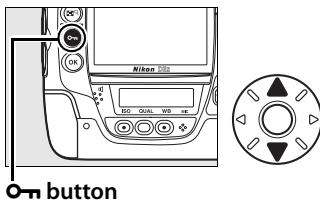


To create an index print of all JPEG pictures on the memory card, select [Index print]. See page 271 for more information.




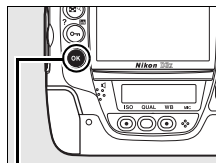
3 Select pictures.

Use the multi selector to scroll through the pictures on the memory card. To display the current picture full screen, press  button. To select the current picture for printing, press the  button and press . The picture will be marked with a  icon and the number of prints will be set to 1. Keeping the  button pressed, press  or  to specify the number of prints (up to 99; to deselect the picture, press  when the number of prints is 1). Continue until all the desired pictures have been selected.

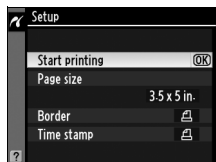


4 Display printing options.

Press  to display PictBridge printing options.

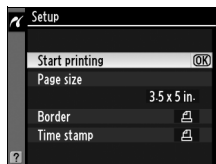


 button



5 Adjust printing options.

Press ▲ or ▼ to highlight an option and press ► to select.



Option	Description
Page size	Menu of page size options will be displayed (pg. 266). Press ▲ or ▼ to choose page size (to print at default page size for current printer, select [Printer default]), then press OK to select and return to previous menu.
Border	Menu of border options will be displayed (pg. 266). Press ▲ or ▼ to choose print style from [Printer default] (default for current printer), [Print with border] (print photo with white border), or [No border], then press OK to select and return to previous menu.
Time stamp	Menu of time stamp options will be displayed (pg. 266). Press ▲ or ▼ to choose [Printer default] (default for current printer), [Print time stamp] (print time and date of recording on photo), or [No time stamp], then press OK to select and return to previous menu.

6 Start printing.

Select [Start printing] and press **OK** to start printing. To cancel before all copies have been printed, press **OK**.



Page Size, Border, Time Stamp, and Cropping

Choose printer default to print at current printer settings. Only options supported by the current printer can be selected. Note that print quality may drop if small crops are printed at large sizes.

See Also

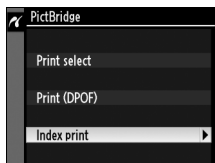
See page 420 for information on what to do if an error occurs during printing.

■ Creating Index Prints

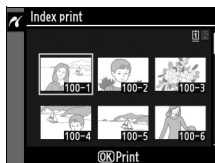
To create an index print of all JPEG pictures on the memory card, select [Index print] in Step 2 of “Printing Multiple Pictures” (pg. 268). Note that if the memory card contains more than 256 pictures, only the first 256 images will be printed.

1 Select [Index print].

Highlight [Index print] in the PictBridge menu (pg. 268) and press **▶**.



The confirmation dialog shown at right will be displayed.

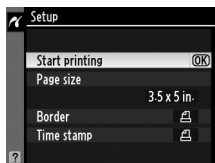


2 Display printing options.

Press **OK** to display PictBridge printing options.

3 Adjust printing options.

Choose page size, border, and time stamp options as described on page 270 (a warning will be displayed if the selected page size is too small).



4 Start printing.

Highlight [Start printing] and press **OK** to start printing. To cancel before printing is complete, press **OK**.



■ Creating a DPOF Print Order: Print Set

The [Print set (DPOF)] option in the playback menu is used to create digital “print orders” for PictBridge-compatible printers and devices that support DPOF. Selecting [Print set (DPOF)] from the playback menu displays the menu shown in Step 1.

1 Choose [Select/set].

Highlight [Select/set] and press

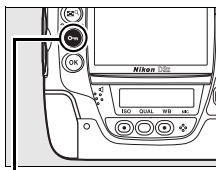


2 Select pictures.

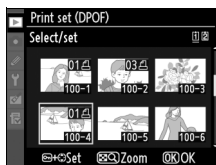
Use the multi selector to scroll through the pictures on the memory card. To display the current picture in full screen, press button. To select the current picture for printing, press the button and press . The picture will be marked with a icon and the number of prints will be set to 1.

Keeping the button

pressed, press or to specify the number of prints (up to 99; to deselect the picture, press when the number of prints is 1). Press when all the desired pictures have been selected.



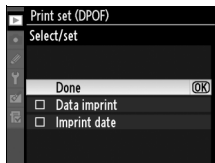
button



3 Select imprint options.

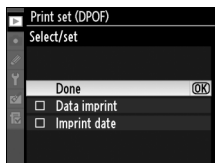
Highlight the following options and press **▶** to toggle the highlighted option on or off (to complete the print order without including this information, proceed to Step 4).

- **[Data imprint]:** Print shutter speed and aperture on all pictures in print order.
- **[Imprint date]:** Print date of recording on all pictures in print order.



4 Complete the print order.

Highlight [Done] and press **OK** to complete the print order.



✓ Print Set

To print the current print order when the camera is connected to a PictBridge printer, select [Print (DPOF)] in the PictBridge menu and follow the steps in “Printing Multiple Pictures” to modify and print the current order (pg. 268). DPOF date and data imprint options are not supported when printing via direct USB connection; to print the date of recording on photographs in the current print order, use the PictBridge [Time stamp] option.

The Print Set option can not be used if there is not enough space on the memory card to store the print order.

Images created at image quality settings of NEF (RAW; pg. 66) can not be selected for printing using this option.

Print orders may not print correctly if images are deleted using a computer or other device after the print order is created.



Viewing Photographs on TV

The supplied EG-D2 audio/video (A/V) cable can be used to connect the D3X to a television or VCR for playback or recording. A type A High-Definition Multimedia Interface (HDMI) cable (available separately from commercial sources) can be used to connect the camera to high-definition video devices.

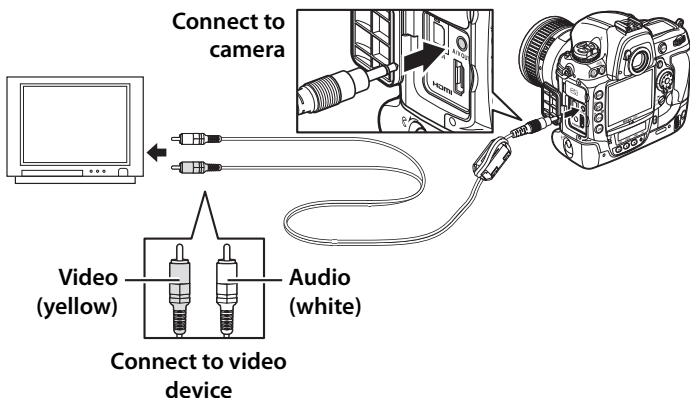
Standard Definition Devices

To connect the camera to a standard television:

1 Turn the camera off.

Always turn the camera off before connecting or disconnecting the A/V cable.

2 Connect the supplied A/V cable as shown.



3 Tune the television to the video channel.

4 Turn the camera on and press button.

During playback, images will be displayed both on the television screen and in the camera monitor.

Video Mode (pg. 348)

Be sure that the video standard matches the standard used in the video device. Note that resolution will drop when images are output on a PAL device.

Television Playback

Use of an EH-6 AC adapter (available separately) is recommended for extended playback. When the EH-6 is connected, the camera monitor-off delay will be fixed at ten minutes and the exposure meters will no longer turn off automatically. Note that the edges may not be visible when photographs are viewed on a television screen.

Audio Output (pg. 254)

Set [HDMI/audio-video output] to play back or record voice memos on the video device.

Slide Shows

The [Slide show] option in the playback menu can be used for automated playback (pg. 288).



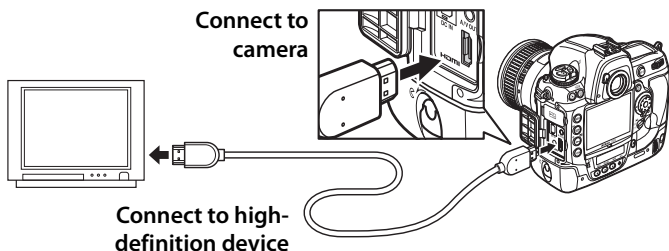
High-Definition Devices

The camera can be connected to HDMI devices using a type A HDMI cable (available separately from commercial sources).

1 Turn the camera off.

Always turn the camera off before connecting or disconnecting an HDMI cable.

2 Connect the HDMI cable as shown.



3 Tune the device to the HDMI channel.

4 Turn the camera on and press button.

During playback, images will be displayed on the high-definition television or monitor screen; the camera monitor will remain off.

HDMI (pg. 348)

At the default setting of [Auto], the camera automatically selects the appropriate HDMI format for the high-definition device. The HDMI format can be chosen using the [HDMI] option in the setup menu (pg. 348).



Menu Guide

This chapter describes the options available in the camera menus.

- ▶ **The Playback Menu: Managing Images pg. 278**
- 📷 **The Shooting Menu: Shooting Options..... pg. 290**
- ✎ **Custom Settings: Fine-Tuning
Camera Settings pg. 302**
- ⚙ **The Setup Menu: Camera Setup..... pg. 346**
- ✂ **The Retouch Menu: Creating
Retouched Copies pg. 363**
- 🔧 **My Menu: Creating a Custom Menu pg. 376**



The Playback Menu: Managing Images

The playback menu contains the options listed below. For information on using the playback menu, see “Tutorial: Camera Menus” (pg. 26).

Option	See page
Delete	281
Playback folder	281
Hide image	281
Display mode	282
Copy image(s)	283
Image review	287
After delete	287
Rotate tall	287
Slide show	288
Print set (DPOF)	289




Selecting Multiple Pictures




To select multiple pictures for [Delete] (pg. 281), [Hide image] (pg. 281), [Print set (DPOF)] (pg. 272), and direct printing (pg. 268):

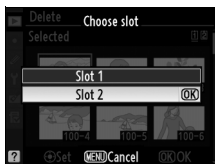
1 Highlight a picture.






To view the highlighted picture full screen, press and hold the  button.

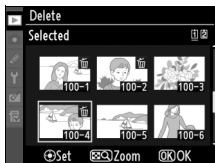


If two memory cards are inserted, the slot can be selected by holding the  button and pressing . The menu shown at right will be displayed (pg. 228); highlight the desired slot and press .



2 Press the center of the multi selector to select the highlighted picture.

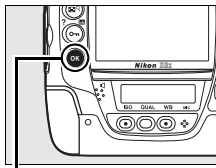
Selected pictures are marked by an icon. When selecting pictures for printing, press the  button and press  or  to choose the number of copies.



3 Repeat steps 1 and 2 to select additional pictures.

To deselect a picture, highlight it and press center of multi selector.

4 Press **OK** to complete the operation.





OK button

A confirmation dialog will be displayed; highlight [Yes] and press **OK**.



Delete

Select this option to delete pictures and their associated voice memos. Protected and hidden images will not be deleted.

Option	Description
 Selected	Delete selected pictures.
 All	Delete all pictures in the folder currently selected for playback (pg. 281). If two memory cards are inserted, a slot selection dialog will be displayed before deletion.

Playback Folder

Choose a folder for playback.

Option	Description
NCD3X (default)	Pictures in all folders created with the D3X will be visible during playback.
All	Pictures in all folders will be visible during playback.
Current	Only pictures in the current folder will be visible during playback.

Hide Image

Hide or reveal selected pictures. Hidden pictures are visible only in the [Hide image] menu and can only be deleted by formatting the memory card.

Option	Description
Select/set	Hide or reveal selected pictures.
Deselect all?	Reveal all pictures.

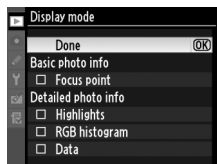
Protected and Hidden Images

Revealing a protected image will also remove protection from the image.



Display Mode

Choose the information available in the playback photo information display (pg. 229). Press ▲ or ▼ to highlight an option, then press ► to select the option for the photo information display. A ✓ appears next to selected items; to deselect, highlight and press ►. To return to the playback menu, highlight [Done] and press Ⓞ.



Option	Description
Basic photo info	
Focus point	Active focus point (or, in single-servo AF, focus point where focus first locked) is shown in red in photo information display. No focus point is displayed if camera was unable to focus using continuous-servo autofocus or if continuous-servo autofocus was used with auto-area AF.
Detailed photo info	
Highlights	Highlights for master RGB channel and for individual red, green, and blue channels are shown in photo information display. Very bright areas blink on and off.
RGB histogram	Red, green, and blue histograms are displayed in photo information display.
Data	Shooting data pages (including camera name, metering, exposure, focal length, white balance, and image options) appear in photo information display.



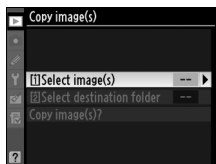
Copy Image(s)

Copy photographs from the memory card in slot 1 to the memory card in slot 2.

Option	Description
1 Select image(s)	Select photographs from memory card in slot 1.
2 Select destination folder	Select destination folder on memory card in slot 2.
Copy image(s)?	Copy selected photographs to specified destination.

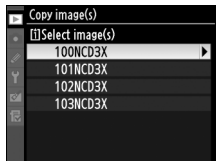
1 Choose [Select image(s)].

Highlight [Select image(s)] and press ►.



2 Choose the source folder.

Highlight the folder containing the images to be copied and press ►.



3 Preselect all or protected images.

Highlight one of the following options and press ►:

- **[Deselect all]:** No images will be preselected. Choose this option when selecting individual images by hand.
- **[Select all images]:** Preselect all images in the current folder. Choose this option when selecting all or most images in the current folder to be copied.
- **[Select protected images]:** Preselect all protected images in the current folder.



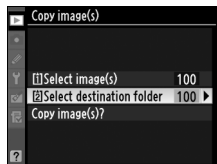
4 Select images.

Images preselected in Step 3 are marked by a ✓ icon. To select additional images or deselect preselected pictures, highlight the image and press the center of the multi selector. Press **OK** to return to the [Copy image(s)] menu when selection is complete.



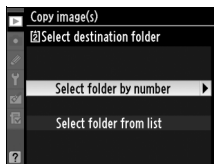
5 Choose [Select destination folder].


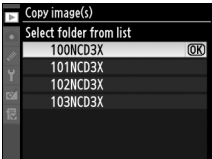
Highlight [Select destination folder] and press ►.



6 Choose a selection method.

Highlight one of the following options and press **▶**.



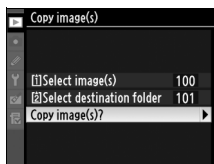
Option	Description
Select folder by number	Enter number of destination folder (pg. 294). 
Select folder from list	Select destination folder from list. 

7 Select a destination folder.

Enter the desired folder number or highlight the destination folder and press **OK** to select the folder and return to the [Copy image(s)] menu.

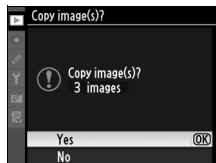
8 Select [Copy image(s)?].

Highlight [Copy image(s)?] and press **▶**.



9 Select [Yes].

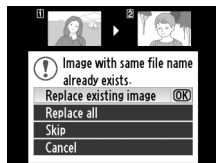
A confirmation dialog will be displayed. Highlight [Yes] and press **OK**.



✓ Copy Image(s)?

Images can only be copied if there is sufficient space on the destination memory card. Hidden pictures can not be copied.

If the destination folder contains a file with the same name as a file selected for copying, a warning will be displayed. To replace the existing file, highlight [Replace existing image] or [Replace all] and press **OK**. Hidden or protected files in the destination folder will not be replaced.




Select [Skip] to cancel replacement and proceed to copy remaining files. Select [Cancel] to cancel before copying is complete.

Copies have the same protect marking as the original; print marking is not copied. Voice memos will be copied with their associated images.






Image Review

Choose whether pictures are automatically displayed in the monitor immediately after shooting.

Option	Description
On	Pictures are automatically displayed in the monitor after shooting.
Off (default)	Pictures can only be displayed by pressing  button.

After Delete

Choose the picture displayed after an image is deleted.

Option	Description
 Show next (default)	Display following picture. If deleted picture was last frame, previous picture will be displayed.
 Show previous	Display previous picture. If deleted picture was first frame, following picture will be displayed.
 Continue as before	If user was scrolling through pictures in order recorded, following picture will be displayed as described for [Show next]. If user was scrolling through pictures in reverse order, previous picture will be displayed as described for [Show previous].

Rotate Tall

Choose whether to rotate “tall” (portrait-orientation) pictures for display during playback. Note that because the camera itself is already in the appropriate orientation during shooting, images are not rotated automatically during image review (pg. 228).

Option	Description
On	“Tall” (portrait-orientation) pictures are automatically rotated for display in the camera monitor. Pictures taken with [Off] selected for [Auto image rotation] (pg. 351) will be displayed in “wide” (landscape) orientation.
Off (default)	“Tall” (portrait-orientation) pictures are displayed in “wide” (landscape) orientation.







Slide Show

Create a slide show of the pictures in the current playback folder (pg. 281). Hidden images (pg. 281) are not displayed.

Option	Description
Start	Start slide show.
Frame interval	Choose how long each picture will be displayed.
Audio playback	Display menu of voice memo playback options (pg. 289).

To start the slide show, highlight [Start] and press **OK**. The following operations can be performed while the slide show is in progress:

To	Press	Description
Skip back/skip ahead		Press ◀ to return to previous frame, ▶ to skip to next frame.
View additional photo info		Change photo info displayed (pg. 229).
Pause slide show	OK	Pause slide show (see following page). Voice memo playback may continue after OK button has been pressed.
Exit to playback menu	MENU	End slide show and return to playback menu.
Exit to playback mode		End slide show and exit to full-frame (pg. 226) or thumbnail playback (pg. 241).
Exit to shooting mode		Press shutter-release button halfway to return to shooting mode.



A dialog shown at right is displayed when the show ends or when the **OK** button is pressed to pause playback. Select [Restart] to restart (if the slide was paused, the show will resume from the next slide) or [Exit] to return to the playback menu.



■ ■ **Audio Playback**

Choose [On] to play voice memos during slide shows. The following options will be displayed:

Option	Description
Frame interval	Playback ends when next frame is displayed, even if entire memo has not been played.
Length of voice memo	Next frame is not displayed until entire memo has been played, even if frame interval is shorter than voice memo.

Choose [Off] (the default option) to disable voice memo playback during slide shows.

Print Set (DPOF)

Choose [Select/set] to select pictures for printing on a DPOF-compatible device (pg. 272). Choose [Deselect all?] to remove all pictures from the current print order.



The Shooting Menu: Shooting Options

The shooting menu contains the options listed below. For information on using the shooting menu, see “Tutorial: Camera Menus” (pg. 26).

Option	See page
Shooting menu bank	291
Reset shooting menu	293
Active folder	293
File naming	296
Slot 2	72
Image quality	66
Image size	70
Image area	60
JPEG compression	68
NEF (RAW) recording	69
White balance	140
Set Picture Control	162
Manage Picture Control	170
Color space	183
Active D-Lighting	181
Vignette control	299
Long exp. NR	300
High ISO NR	300
ISO sensitivity settings	104
Live view	90
Multiple exposure	206
Interval timer shooting	211



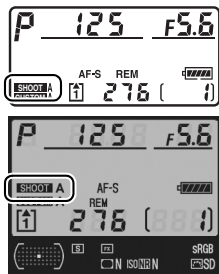
Shooting Menu Bank

Shooting menu options are stored in one of four banks. With the exceptions of [Interval timer shooting], [Multiple exposure], and modifications to Picture Controls (quick adjust and other manual adjustments), changes to settings in one bank have no effect on the others. To store a particular combination of frequently-used settings, select one of the four banks and set the camera to these settings. The new settings will be stored in the bank even when the camera is turned off, and will be restored the next time the bank is selected. Different combinations of settings can be stored in the other banks, allowing the user to switch instantly from one combination to another by selecting the appropriate bank from the bank menu.

The default names for the four shooting menu banks are A, B, C, and D. A descriptive caption can be added using the [Rename] option as described below.

Shooting Menu Bank


The top control panel and shooting information displays show the current shooting menu bank.

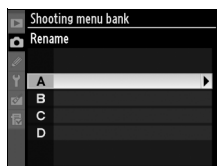


Renaming Shooting Menu Banks





Selecting [Rename] in the [Shooting menu bank] menu displays the list of shooting menu banks shown in Step 1.

1 Select a bank.

Highlight the desired bank and press .



2 Enter a name.

To move the cursor in the name area, press the  button and press  or . To enter a new letter at the current cursor position, use the multi selector to highlight the desired character in the keyboard area and press the center of the multi selector. To delete the character at the current cursor position, press the  button. To return to the shooting menu without changing the bank name, press the **MENU** button.




Keyboard area

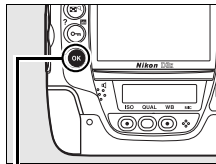


Name area

Bank names can be up to twenty characters long. Any characters after the twentieth will be deleted.

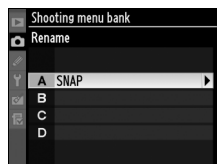
3 Save changes and exit.

After editing the name, press  to save changes and exit.



button

The [Shooting menu bank] menu will be displayed.



Reset Shooting Menu

Choose whether to restore default settings for the current shooting menu bank. See page 423 for a list of default settings. With the exceptions of image quality, image size, white balance, and ISO sensitivity, shooting menu settings are not reset when a two-button reset (pg. 204) is performed.

Option	Description
Yes	Restore defaults for the current shooting menu bank.
No (default)	Exit without changing shooting menu settings.

Active Folder

Select the folder in which subsequent images will be stored.




■ ■ *New Folder Number*




1 Select [New folder number].

Highlight [New folder number] and press ►.



2 Choose a folder number.

Press the ◀ or ▶ to highlight a digit, press ▲ or ▼ to change. If a folder with the selected number already exists, a , , or  icon will be displayed to the left of the folder number:

- : Folder is empty.
- : Folder is partially full.
- : Folder contains 999 pictures or a picture numbered 9999. No further pictures can be stored in this folder.

3 Save changes and exit.

Press **OK** to complete the operation and return to the shooting menu (to exit without changing the active folder, press the **MENU** button). If a folder with the specified number does not already exist, a new folder will be created. Subsequent photographs will be stored in the selected folder unless it is already full.



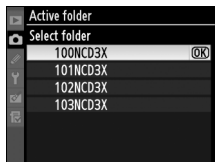
■ Select Folder

1 Choose [Select folder].

Highlight [Select folder] and press ►.

2 Highlight a folder.

Press ▲ or ▼ to highlight a folder.



3 Select the highlighted folder.

Press **OK** to select the highlighted folder and return to the shooting menu (to exit without changing the active folder, press the **MENU** button). Subsequent photographs will be stored in the selected folder.

✓ Folder and File Numbers

If the current folder is numbered 999 and contains 999 pictures or a picture numbered 9999, the shutter-release will be disabled and no further photographs can be taken. To continue shooting, create a folder with a number less than 999, or select an existing folder with a number less than 999 and less than 999 images.

✎ Number of Folders

Additional time may be required for camera startup if the memory card contains a very large number of folders.



File Naming

Photographs are saved using file names consisting of “DSC_” or, in the case of images that use the Adobe RGB color space, “_DSC”, followed by a four-digit number and a three-letter extension (e.g., “DSC_0001.JPG”). The [File naming] option is used to select three letters to replace the “DSC” portion of the file name. For information on editing file names, see steps 2 and 3 of “Renaming Shooting Menu Banks” (pg. 292). Note that the portion of the name that can be edited is a maximum of three characters long.

Extensions

The following extensions are used: “.NEF” for NEF (RAW) images, “.TIF” for TIFF (RGB) images, “.JPG” for JPEG images, and “.NDF” for dust off reference data.

Slot 2

Choose the role played by the secondary card slot when two memory cards are inserted in the camera (pg. 72).

Image Quality

Choose image quality (pg. 66).



Image Size

Choose the size at which pictures are recorded (pg. 70).

Image Area

Although the D3X can record photographs with the same diagonal picture angle as a 35mm format camera using a 3 : 2 aspect ratio, it can also be used to record photographs with the smaller DX picture angle or the 5 : 4 aspect ratio (pg. 60).

JPEG Compression

Choose whether to compress JPEG images to a fixed size or to vary file size for improved image quality (pg. 68).

NEF (RAW) Recording

Choose compression and bit-depth options for NEF (RAW) images (pg. 69).

White Balance

Adjust white balance settings (pg. 140).



Set Picture Control

Select from the Picture Controls provided with the camera to instantly adjust image processing settings (pg. 162).

Manage Picture Control

Save and modify custom Picture Control combinations, or copy custom Picture Controls to or from the memory card (pg. 170).

Color Space

Choose from sRGB and Adobe RGB color spaces (pg. 183).

Active D-Lighting

This option can be used to prevent loss of detail in highlights and shadows (pg. 181). The default setting is [Off].



Vignette Control

“Vignetting” is a drop in brightness at the edges of a photograph. [Vignette control] reduces vignetting for type G and D lenses (DX and PC lenses excluded). Its effects vary from lens to lens and are most noticeable at maximum aperture. Choose from [High], [Normal] (the default setting), [Low], and [Off].

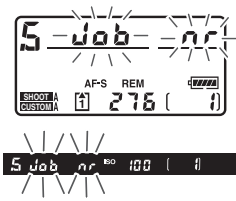
Vignette Control

Depending on the scene, shooting conditions, and type of lens, TIFF and JPEG images may exhibit unevenness or variations in peripheral brightness, while custom Picture Controls and Nikon Picture Controls that have been modified from default settings may not produce the desired effect. Take test shots and view the results in the monitor. Vignette control does not apply to multiple exposures (pg. 206), DX-format images (pg. 60), or images created with [Image overlay] (pg. 371). The effects of vignette control can not be previewed in live view (pg. 90).



Long Exp. NR (Long Exposure Noise Reduction)

Choose whether to reduce noise in pictures taken at slow shutter speeds.

Option	Description
On	<p>Photographs taken at shutter speeds slower than 8s are processed to reduce noise. While photographs are being processed, “Job nr” will blink in the shutter speed/aperture displays for a period of time approximately equal to the current shutter speed. In continuous release mode, frame rates will slow and the capacity of the memory buffer will drop. Photographs can not be taken until processing is complete and “Job nr” has cleared from the displays. Noise reduction will not be performed if the camera is turned off before processing is complete.</p> 
Off (default)	Long exposure noise reduction off.

High ISO NR

Photographs taken at high ISO sensitivities can be processed to reduce “noise.”

Option	Description
HIGH High	Noise reduction is performed at ISO sensitivities of ISO 500 and higher. While photographs are being processed, the capacity of the memory buffer will drop. Choose the amount of noise reduction performed from [High], [Normal], and [Low].
NORM Normal (default)	
LOW Low	
Off	Noise reduction is only performed at sensitivities of Hi 0.3 and higher. The amount of noise reduction is less than the amount performed when [Low] is selected for [High ISO NR].

ISO Sensitivity Settings

Adjust ISO sensitivity and ISO sensitivity auto control settings (pp. 104, 106).

Live View

Choose a live view mode and the release mode that will be used when the camera is in live view mode (pg. 91).

Multiple Exposure



Create a single photograph from two to ten exposures (pg. 206).

Interval Timer Shooting

Take photographs automatically at pre-selected intervals. Use for time-lapse movies of such subjects as flowers opening or butterflies emerging from cocoons (pg. 211).

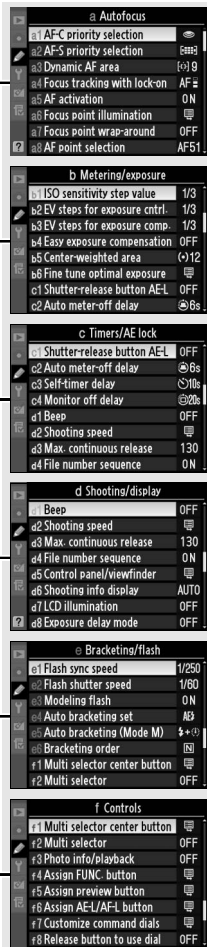
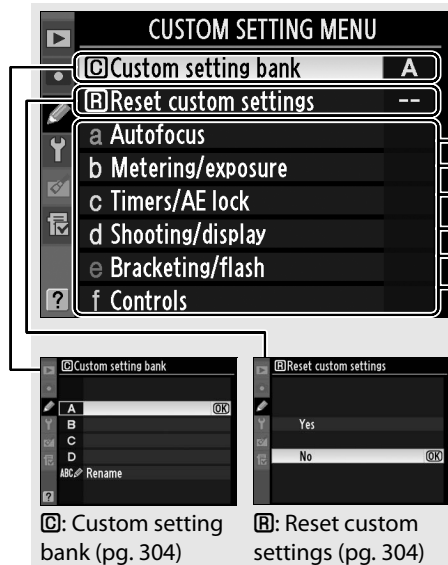


Custom Settings: Fine-Tuning Camera Settings

Custom Settings are used to customize camera settings to suit individual preferences. In addition to Custom Settings  ([Custom setting bank]) and  ([Reset custom settings]), settings in the Custom Settings menu are divided into the six groups shown at right.

Custom Setting groups

Main menu



The following Custom Settings are available:

Custom Setting		Page	Custom Setting		Page
C	Custom setting bank	304	d	Shooting/display	
R	Reset custom settings	304	d1	Beep	320
a	Autofocus		d2	Shooting speed	321
a1	AF-C priority selection	305	d3	Max. continuous release	321
a2	AF-S priority selection	306	d4	File number sequence	322
a3	Dynamic AF area	307	d5	Control panel/viewfinder	323
a4	Focus tracking with lock-on	309	d6	Shooting info display	324
a5	AF activation	309	d7	LCD illumination	325
a6	Focus point illumination	310	d8	Exposure delay mode	325
a7	Focus point wrap-around	311	e	Bracketing/flash	
a8	AF point selection	311	e1	Flash sync speed	326
a9	AF-ON button	312	e2	Flash shutter speed	327
a10	Vertical AF-ON button	313	e3	Modeling flash	327
b	Metering/exposure		e4	Auto bracketing set	328
b1	ISO sensitivity step value	314	e5	Auto bracketing (Mode M)	329
b2	EV steps for exposure cntrl.	314	e6	Bracketing order	330
b3	EV steps for exposure comp.	314	f	Controls	
b4	Easy exposure compensation	315	f1	Multi selector center button	331
b5	Center-weighted area	316	f2	Multi selector	332
b6	Fine tune optimal exposure	316	f3	Photo info/playback	332
c	Timers/AE lock		f4	Assign FUNC. button	333
c1	Shutter-release button AE-L	318	f5	Assign preview button	339
c2	Auto meter-off delay	318	f6	Assign AE-L/AF-L button	340
c3	Self-timer delay	319	f7	Customize command dials	341
c4	Monitor off delay	319	f8	Release button to use dial	343
			f9	No memory card?	344
			f10	Reverse indicators	345



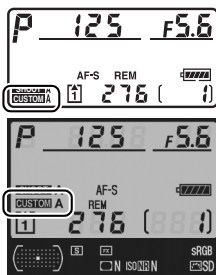
C: Custom Setting Bank

Custom Settings are stored in one of four banks. Changes to settings in one bank have no effect on the others. To store a particular combination of frequently-used settings, select one of the four banks and set the camera to these settings. The new settings will be stored in the bank even when the camera is turned off, and will be restored the next time the bank is selected. Different combinations of settings can be stored in the other banks, allowing the user to switch instantly from one combination to another by selecting the appropriate bank from the bank menu.

The default names for the four Custom Settings banks are A, B, C, and D. A descriptive caption can be added using the [Rename] option as described on page 291.

C Custom Settings Bank

The bank letter appears in the top control panel and shooting information displays. If settings in the current bank have been modified from default values, an asterisk will be displayed adjacent to the altered settings in the second level of the Custom Settings menu.



R: Reset Custom Settings

Choose whether to restore default settings for the current Custom Settings bank. See page 424 for a list of default settings. Custom Settings are not reset when a two-button reset is performed.

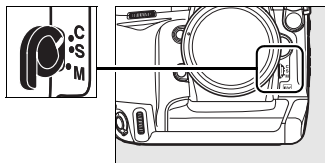
Option	Description
Yes	Restore defaults for the current Custom Settings bank.
No (default)	Exit without changing Custom Settings.




a: Autofocus

a1: AF-C Priority Selection

This option controls whether photographs can be taken whenever the shutter-release button is pressed (*release priority*) or only when the camera is in focus (*focus priority*) in continuous-servo AF. To select continuous-servo AF, rotate the focus mode selector to **C**.

Focus mode selector



Option	Description
 Release (default)	Photos can be taken whenever the shutter-release button is pressed.
 Release + focus	Photos can be taken even when the camera is not in focus. In continuous mode, frame rate slows for improved focus if the subject is dark or low contrast.
 Focus	Photos can only be taken when the in-focus indicator (●) is displayed.

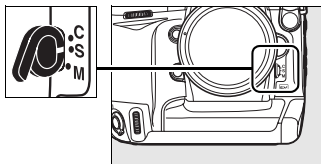
Regardless of the option selected, focus will not lock when the in-focus indicator (●) is displayed.





a2: AF-S Priority Selection

This option controls whether photographs can be taken only when the camera is in focus (*focus priority*) or whenever the shutter-release button is pressed (*release priority*) in single-servo AF. To select single-servo AF, rotate the focus mode selector to **S**.

Focus mode selector



Option	Description
 Release	Photos can be taken whenever the shutter-release button is pressed.
 Focus (default)	Photos can only be taken when the in-focus indicator (●) is displayed.

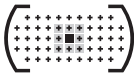
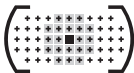
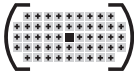
Regardless of the option selected, focus will lock while the in-focus indicator (●) is displayed.



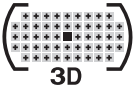
a3: Dynamic AF Area

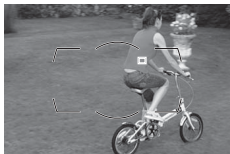
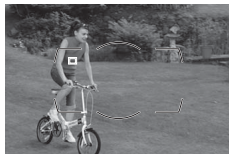
If the subject leaves the selected focus point when dynamic-area AF (☺; pg. 76) is selected in continuous-servo AF (focus mode C; pg. 74), the camera will focus based on information from surrounding focus points. Choose the number of points from 9, 21, and 51 based on subject movement.

Only active focus point is displayed in the viewfinder. Remaining focus points provide information to assist focus operation.

Option	Description
<p>☺9 9 points (default)</p> 	<p>If the subject leaves the selected focus point, the camera will focus based on information from the surrounding eight focus points. Choose when there is time to compose the photograph or when photographing subjects that are moving predictably (e.g., runners or race cars on a track).</p>
<p>☺21 21 points</p> 	<p>If the subject leaves the selected focus point, the camera will focus based on information from the surrounding 20 focus points. Choose when photographing subjects that are moving unpredictably (e.g., players at a football game).</p>
<p>☺51 51 points</p> 	<p>If the subject leaves the selected focus point, the camera will focus based on information from the surrounding 50 focus points. Choose when photographing subjects that are moving quickly and can not be easily framed in the viewfinder (e.g., birds).</p>



Option	Description
<p data-bbox="99 165 324 225">[Fn]3D 51 points (3D-tracking)</p> 	<p data-bbox="337 95 915 378">If the subject leaves the selected focus point, the camera will use 3D-tracking to track the subject and select a new focus point as required. Use to quickly compose pictures with subjects that are moving erratically from side to side (e.g., tennis players). If the subject leaves the viewfinder, remove your finger from the shutter-release button and recompose the photograph with the subject in the selected focus point.</p>



3D-Tracking

When the shutter-release button is pressed halfway, the colors in the area surrounding the focus point are stored in the camera. Consequently 3D-tracking may not produce the desired results with subjects that are the same color as the background or that occupy a very small area of the frame.




See Also

For information on using the **Fn** button and command dials to select the number of focus points for dynamic-area AF, see Custom Setting f4 ([Assign FUNC. button]) > [FUNC. button+dials] > [Dynamic AF area] (pg. 336).



a4: Focus Tracking with Lock-On

This option controls how autofocus adjusts to sudden large changes in the distance to the subject.

Option	Description
AF  Long	When the distance to the subject changes abruptly, the camera waits for the specified period (long, normal, or short) before adjusting the distance to the subject. This prevents the camera from refocusing when the subject is briefly obscured by objects passing through the frame.
AF  Normal (default)	
AF  Short	
Off	The camera immediately adjusts focus when the distance to the subject changes. Use when photographing a series of subjects at varying distances in quick succession.

a5: AF Activation

This option controls whether both the shutter-release button and the **AF-ON** button can be used to initiate autofocus, or whether autofocus is only initiated when the **AF-ON** button is pressed.

Option	Description
Shutter/ AF-ON (default)	Autofocus can be performed with the AF-ON button or by pressing the shutter-release button halfway.
AF-ON only	Autofocus can only be performed using the AF-ON button.



a6: Focus Point Illumination

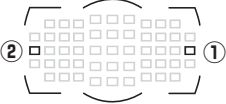
The options in this menu control whether or not the focus points are illuminated.

Option	Description
Manual focus mode	Choose [On] (the default setting) to display the active focus point in manual focus mode.
Continuous mode	Choose [On] (the default setting) to display the active focus point in C_H (continuous high-speed) and C_L (continuous low-speed) modes.
Focus point brightness	Choose the brightness of the focus point display in the viewfinder from [Extra high], [High], [Normal] (the default setting), and [Low].



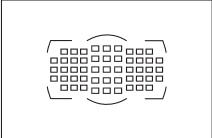
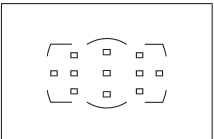
a7: Focus Point Wrap-Around

Choose whether focus-point selection “wraps around” from one edge of the viewfinder to another.

Option	Description
Wrap	Focus-point selection “wraps around” from top to bottom, bottom to top, right to left, and left to right, so that, for example, pressing ► when a focus point at the right edge of the viewfinder display is highlighted (①) selects the corresponding focus point at the left edge of the display (②). 
No wrap (default)	The focus-area display is bounded by the outermost focus points so that, for example, pressing ► when a focus point at the right edge of the display is selected has no effect.

a8: AF Point Selection

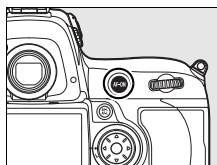
Choose the number of focus points available for manual focus-point selection.







Option	Description
AF51 51 points (default)	Choose from the 51 focus points shown at right. 
AF11 11 points	Choose from the 11 focus points shown at right. Use for quick focus-point selection. 



a9: AF-ON Button

Choose the function performed when the AF-ON button is pressed.

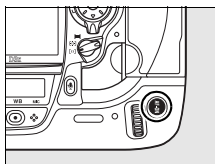









Option	Description
 AF-ON (default)	Pressing the AF-ON button initiates autofocus.
 AE/AF lock	Focus and exposure lock while the AF-ON button is pressed.
 AE lock only	Exposure locks while the AF-ON button is pressed.
 AE lock (Reset on release)	Exposure locks when the AF-ON button is pressed, and remains locked until the button is pressed a second time, the shutter is released, or the exposure meters turn off.
 AE lock (Hold)	Exposure locks when the AF-ON button is pressed, and remains locked until the button is pressed a second time or the exposure meters turn off.
 AF lock only	Focus locks while the AF-ON button is pressed.



a10: Vertical AF-ON Button

Choose the function assigned to the **AF-ON** button for vertical shooting.



Option	Description
 Same as AF-ON	Both AF-ON buttons perform the function selected for Custom Setting a9.
 AF-ON (default)	Pressing the vertical AF-ON button initiates autofocus.
 AE/AF lock	Focus and exposure lock while the vertical AF-ON button is pressed.
 AE lock only	Exposure locks while the vertical AF-ON button is pressed.
 AE lock (Reset on release)	Exposure locks when the vertical AF-ON button is pressed, and remains locked until the button is pressed a second time, the shutter is released, or the exposure meters turn off.
 AE lock (Hold)	Exposure locks when the vertical AF-ON button is pressed, and remains locked until the button is pressed a second time or the exposure meters turn off.
 AF lock only	Focus locks while the vertical AF-ON button is pressed.



b: Metering/Exposure

b1: ISO Sensitivity Step Value

This option determines whether adjustments to sensitivity are made in increments equivalent to $1/3$ EV, $1/2$ EV, or 1 EV.

	Option
1/3	1/3 step (default)
1/2	1/2 step
1	1 step

b2: EV Steps for Exposure Cntrl.

This option determines whether adjustments to shutter speed, aperture, and bracketing are made in increments equivalent to $1/3$ EV, $1/2$ EV, or 1 EV.

Option	Description
1/3 1/3 step (default)	Changes to shutter speed and aperture are in increments equivalent to $1/3$ EV. The bracketing increment can be selected from $1/3$, $2/3$, and 1 EV.
1/2 1/2 step	Changes to shutter speed and aperture are in increments equivalent to $1/2$ EV. The bracketing increment can be selected from $1/2$ and 1 EV.
1 1 step	Changes to shutter speed and aperture are in increments equivalent to 1 EV. The bracketing increment is set to 1 EV.


b3: EV Steps for Exposure Comp.



This option determines whether adjustments to exposure compensation are made in increments equivalent to $1/3$ EV, $1/2$ EV, or 1 EV.

	Option
1/3	1/3 step (default)
1/2	1/2 step
1	1 step



b4: Easy Exposure Compensation

This option controls whether the  button is needed to set exposure compensation (pg. 128). If [On (Auto reset)] or [On] is selected, the 0 at the center of the exposure display will blink even when exposure compensation is set to ± 0 .

Option	Description
RESET On (Auto reset)	Exposure compensation is set by rotating one of the command dials (see note below). The setting selected using the command dial is reset when the camera or exposure meters turn off (exposure compensation settings selected using the  button are not reset).
On	As above, except that the exposure compensation value selected using the command dial is not reset when the camera or exposure meters turn off.
Off (default)	Exposure compensation is set by pressing the  button and rotating the main command dial.

Change Main/Sub

The dial used to set exposure compensation when [On (Auto reset)] or [On] is selected for Custom Setting b4 ([Easy exposure compensation]) depends on the option selected for Custom Setting f7 ([Customize command dials]) > [Change main/sub] (pg. 341).

		Customize command dials > Change main/sub	
		Off (default)	On
Exposure mode	P	Sub-command dial	Sub-command dial
	S	Sub-command dial	Main command dial
	A	Main command dial	Sub-command dial
	M	N/A	



b5: Center-Weighted Area

When calculating exposure, center-weighted metering assigns the greatest weight to a circle in the center of the frame. The diameter (ϕ) of this circle can be set to 8, 12, 15, or 20 mm or to the average of the entire frame.

Option	
(◂) 8 ϕ	8 mm
(◂) 12 ϕ	12 mm (default)
(◂) 15 ϕ	15 mm
(◂) 20 ϕ	20 mm
(◂) Avg	Average

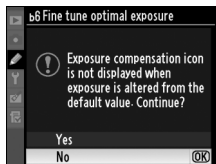
Note that unless [Average] is selected, the diameter is fixed at 12 mm when a non-CPU lens is used, regardless of the setting selected for [Non-CPU lens data] in the setup menu (pg. 218). When [Average] is selected, the average of the entire frame will be used for both CPU and non-CPU lenses.

b6: Fine Tune Optimal Exposure

Use this option to fine-tune the exposure value selected by the camera. Exposure can be fine-tuned separately for each metering method by from +1 to -1 EV in steps of $\frac{1}{6}$ EV.

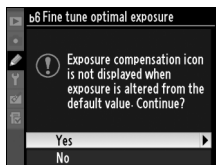
1 Select Custom Setting b6.

Highlight Custom Setting b6 ([Fine tune optimal exposure]) and press **▶**.



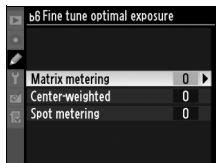
2 Select [Yes].

The message shown at right will be displayed; highlight [Yes] and press **▶** to proceed, or select [No] to exit without altering exposure.



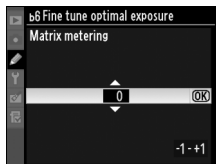
3 Select a metering method.

Highlight [Matrix metering], [Center-weighted], or [Spot metering] and press ►.



4 Choose an exposure value.

Press ▲ or ▼ to choose an exposure value from +1 to -1 EV. Press OK to save changes and exit.



☑ Fine-Tuning Exposure

Exposure can be fine-tuned separately for each Custom Settings bank and is not affected by two-button resets. Note that as the exposure compensation (☑) icon is not displayed, the only way to determine how much exposure has been altered is to view the amount in the fine-tuning menu. Exposure compensation (pg. 128) is preferred in most situations.













c: Timers/AE Lock

c1: Shutter-Release Button AE-L

At the default setting of [Off], exposure only locks when the **AE-L/AF-L** button is pressed. If [On] is selected, exposure will also lock when the shutter-release button is pressed halfway.

c2: Auto Meter-off Delay

This option controls how long the camera continues to meter exposure when no operations are performed. Choose from 4 s, 6 s, 8 s, 16 s, 30 s, 1 minute, 5 minutes, 10 minutes, 30 minutes, or until the camera is turned off ([No limit]). The shutter-speed and aperture displays in the top control panel and viewfinder turn off automatically when the exposure meters turn off.





Option	
 4s	4 s
 6s	6 s (default)
 8s	8 s
 16s	16 s
 30s	30 s
 1m	1 min.
 5m	5 min.
 10m	10 min.
 30m	30 min.
 ∞	No limit

Choose a shorter meter-off delay for longer battery life. When the camera is powered by an optional EH-6 adapter, the auto meter-off delay is equivalent to [No limit].








c3: Self-Timer Delay

This option controls the length of the shutter release delay in self-timer mode. Choose from 2 s, 5 s, 10 s, and 20 s.

Option	
 2s	2 s
 5s	5 s
 10s	10 s (default)
 20s	20 s

c4: Monitor off Delay

This option controls how long the monitor remains on when no operations are performed. Choose from 10 s, 20 s, 1 minute, 5 minutes, or 10 minutes. Choose a shorter monitor-off delay for longer battery life. Regardless of the setting chosen, the monitor remains on if no operations are performed for about ten minutes when the camera is powered by an optional EH-6 AC adapter.




Option	
 10s	10 s
 20s	20 s (default)
 1m	1 min.
 5m	5 min.
 10m	10 min.

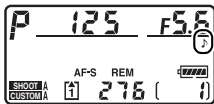


d: Shooting/Display

d1: Beep

Choose [High] or [Low] to sound a beep when the self-timer is used or the camera focuses in single-servo autofocus (note that a beep will not sound if [Release] is selected for Custom Setting a2 ([AF-S priority selection], pg. 306).

Option	Description
 H High	Choose the pitch of the beep from [High] and [Low]. A  icon is displayed in the top control panel and shooting information displays.
 L Low	
Off (default)	Turn the beep speaker off.



d2: Shooting Speed

Choose the maximum frame advance rate for **C_H** (continuous high-speed) and **C_L** (continuous low-speed) modes. Note that the frame advance rate may drop below the selected value at slow shutter speeds, or when using VR (vibration reduction) mode with VR lenses.

Option	Description
Continuous high-speed	In C_H (continuous high-speed) mode, the frame advance rate for DX format (pg. 61) can be selected from 5 (the default setting), 6, and 7 frames per second (fps). Regardless of the setting chosen, the maximum frame rate for other formats is fixed at 5 fps.
Continuous low-speed	Choose the frame advance rate for C_L (continuous low-speed) mode from values between 1 and 5 fps. The default setting is 3 fps.

d3: Max. Continuous Release

The maximum number of shots that can be taken in a single burst in continuous mode can be set to any value between 1 and 130.

The Memory Buffer

Regardless of the option selected for Custom Setting d3, shooting will slow when the memory buffer fills. See page 427 for more information on the capacity of the memory buffer.



d4: File Number Sequence

When a photograph is taken, the camera names the file by adding one to the last file number used. This option controls whether file numbering continues from the last number used when a new folder is created, the memory card is formatted, or a new memory card is inserted in the camera.

Option	Description
On (default)	When a new folder is created, the memory card formatted, or a new memory card inserted in the camera, file numbering continues from the last number used or from the largest file number in the current folder, whichever is higher. If a photograph is taken when the current folder contains a photograph numbered 9999, a new folder will be created automatically and file numbering will begin again from 0001.
Off	File numbering is reset to 0001 when a new folder is created, the memory card is formatted, or a new memory card is inserted in the camera. Note that a new folder is created automatically if a photograph is taken when the current folder contains 999 photographs.
RESET Reset	Same as for [On], except that the next photograph taken is assigned a file number by adding one to the largest file number in the current folder. If the folder is empty, file numbering is reset to 0001.

File Number Sequence

If the current folder is numbered 999 and contains either 999 photographs or a photograph numbered 9999, the shutter-release button will be disabled and no further photographs can be taken. Choose [Reset] for Custom Setting d4 ([File number sequence]) and then either format the current memory card or insert a new memory card.



d5: Control Panel/Viewfinder

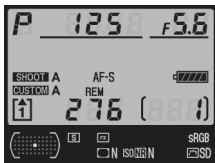
Choose the information displayed in the viewfinder and rear control panel.

Option	Description
Rear control panel	Choose from [ISO sensitivity] (ISO; the default setting) and [Exposures remaining] (C ⁰). If [Exposures remaining] is selected, ISO sensitivity will only be displayed while the ISO button is pressed.
Viewfinder display	Choose from [Frame count] (000; the default setting) and [Exposures remaining] (C ⁰). Note that regardless of the option selected, memory buffer capacity will be shown while the shutter-release button is pressed.



d6: Shooting Info Display

At the default setting of [Auto] (**AUTO**), the color of the lettering in the information display (pg. 14) will automatically change from black to white or white to black to maintain contrast with the background. To always use the same color lettering, select [Manual] and choose [Dark on light] (**B**; black lettering) or [Light on dark] (**W**; white lettering). Monitor brightness will automatically be adjusted for maximum contrast with the selected text color.



Dark on light



Light on dark



d7: LCD Illumination

At the default setting of [Off], the control panel backlights (LCD illuminator) will only light while the power switch is in the **⚡** position. If [On] is selected, the control panels will be illuminated while the exposure meters are active (pg. 50). Select [Off] for increased battery life.

d8: Exposure Delay Mode

At the default setting of [Off], shutter is released when the shutter-release button is pressed. When shooting with [Tripod] selected in live view mode (pg. 94) or in situations where the slightest camera movement can blur pictures, [On] can be selected to delay shutter release until about 1 s after the shutter-release button is pressed and the mirror is raised.



e: Bracketing/Flash

e1: Flash Sync Speed

This option controls flash sync speed.

Option	Description
1/250 s (Auto FP)	Auto FP high-speed sync is used with SB-900, SB-800, SB-600, and SB-R200 flash units. If other flash units are used, shutter speed is set to $1/250$ s. When the camera shows a shutter speed of $1/250$ s in exposure mode P or A , auto FP high-speed sync will be activated if the actual shutter speed is faster than $1/250$ s.
1/250 s (default)	Flash sync speed set to $1/250$ s.
1/200 s	Flash sync speed set to $1/200$ s.
1/160 s	Flash sync speed set to $1/160$ s.
1/125 s	Flash sync speed set to $1/125$ s.
1/100 s	Flash sync speed set to $1/100$ s.
1/80 s	Flash sync speed set to $1/80$ s.
1/60 s	Flash sync speed set to $1/60$ s.

Fixing Shutter Speed at the Flash Sync Speed Limit

To fix shutter speed at the sync speed limit in shutter-priority auto or manual exposure modes, select the next shutter speed after the slowest possible shutter speed (30 s or bulb). An X (flash sync indicator) will be displayed in the viewfinder and top control panel.



e2: Flash Shutter Speed

This option determines the slowest shutter speed available when using front- or rear-curtain sync or red-eye reduction in programmed auto or aperture-priority auto exposure modes (regardless of the setting chosen, shutter speeds can be as slow as 30 s in shutter-priority auto and manual exposure modes or at flash settings of slow sync, slow rear-curtain sync, or red-eye reduction with slow sync). Options range from $\frac{1}{60}$ s ([1/60 s], the default setting) to 30 s ([30 s]).

e3: Modeling Flash

If [On] (the default setting) is selected when the camera is being used with an optional flash unit that supports the Nikon Creative Lighting System (CLS; pg. 186), the flash unit mounted on the camera and any CLS-compatible remote flash units will emit a modeling flash when the camera depth-of-field preview button is pressed (pg. 113). No modeling flash is emitted if [Off] is selected.







e4: Auto Bracketing Set

Choose the setting or settings bracketed when auto bracketing (pg. 130) is in effect. Choose [AE & flash] (~~AE~~); the default setting) to perform both exposure and flash-level bracketing, [AE only] (AE) to bracket only exposure, [Flash only] (⚡) to perform only flash-level bracketing, or [WB bracketing] (WB) to perform white-balance bracketing (pg. 135). Note that white balance bracketing is not available at image quality settings of NEF (RAW) or NEF (RAW) + JPEG.



e5: Auto Bracketing (Mode M)

This option determines which settings are affected when [AE & flash] or [AE only] is selected for Custom Setting e4 in manual exposure mode.

Option	Description
 Flash/speed (default)	Camera varies shutter speed (Custom Setting e4 set to [AE only]) or shutter speed and flash level (Custom Setting e4 set to [AE & flash]).
 Flash/speed/ aperture	Camera varies shutter speed and aperture (Custom Setting e4 set to [AE only]) or shutter speed, aperture, and flash level (Custom Setting e4 set to [AE & flash]).
 Flash/ aperture	Camera varies aperture (Custom Setting e4 set to [AE only]) or aperture and flash level (Custom Setting e4 set to [AE & flash]).
 Flash only	Camera varies flash level only (Custom Setting e4 set to [AE & flash]).

Flash bracketing is performed only with i-TTL or AA flash control. If a setting other than [Flash only] is selected and a flash is not used, ISO sensitivity will be fixed at the value for the first shot, regardless of the setting selected for ISO sensitivity auto control (pg. 106).



e6: Bracketing Order

At the default setting of [MTR]>[under]>[over] (**N**), bracketing is performed in the order described on pages 132 and 136. If [Under]>[MTR]>[over] (-**→+**) is selected, shooting will proceed in order from the lowest to the highest value.



f: Controls

f1: Multi Selector Center Button

This option determines what operations can be performed by pressing the center of the multi selector in shooting, live view, and playback modes.




■ Shooting Mode

Selecting [Shooting mode] displays the following options:

Option	Description
Select center focus point RESET (default)	Pressing the center of the multi selector in shooting mode selects the center focus point.
Not used	Pressing the center of the multi selector has no effect when the camera is in shooting mode.

■ Playback Mode


Selecting [Playback mode] displays the following options:

Option	Description
 Thumbnail on/off (default)	Press the center of the multi selector to toggle between full-frame and thumbnail playback.
 View histograms	In both full-frame and thumbnail playback, a histogram is displayed while the center of the multi selector is pressed.
 Zoom on/off	Press the center of the multi selector to toggle between full-frame or thumbnail playback and playback zoom. Choose the initial zoom setting from [Low magnification], [Medium magnification], and [High magnification]. The zoom display will center on the active focus point.



■ Live View

Selecting [Live view] displays the following options:

Option	Description
Select center focus point (default) RESET	Pressing the center of the multi selector in live view selects the center focus point.
 Zoom on/off	Press the center of the multi selector to toggle zoom on and off. Choose the initial zoom setting from [Low magnification], [Medium magnification], and [High magnification]. The zoom display will center on the active focus point.
Not used	Pressing the center of the multi selector has no effect in live view.

f2: Multi Selector

If [Reset meter-off delay] is selected, operating the multi selector when the exposure meters are off (pg. 50) will activate the exposure meters. If [Do nothing] (the default option) is selected, the exposure meters will not be activated when the multi selector is pressed.

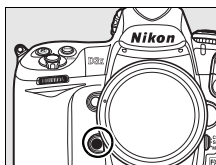
f3: Photo Info/Playback

At the default setting of [Info▲▼/Playback◀▶], pressing ▲ or ▼ in full-frame playback changes the photo information displayed, while pressing ◀ or ▶ displays additional images. To reverse the role of the multi selector buttons so that pressing ▲ or ▼ displays additional images and pressing ◀ or ▶ changes the photo information displayed, select [Info◀▶/Playback▲▼].











f4: Assign FUNC. Button

Choose the role played by the **Fn** button, either by itself ([FUNC. button press]) or when used in combination with the command dials ([FUNC. button+dials]).











■ ■ FUNC. Button Press

Selecting [FUNC. button press] for Custom Setting f4 displays the following options:

Option	Description
 Preview *	Press the Fn button to preview depth of field (pg. 113).
 FV lock *	Press the Fn button to lock flash value (SB-900, SB-800, SB-600, SB-400, and SB-R200 flash units only, pg. 198). Press again to cancel FV lock.
 AE/AF lock	Focus and exposure lock while the Fn button is pressed.
 AE lock only	Exposure locks while the Fn button is pressed.
 AE lock (Reset on release) *	Exposure locks when the Fn button is pressed, and remains locked until the button is pressed a second time, the shutter is released, or the exposure meters turn off.
 AE lock (Hold) *	Exposure locks when the Fn button is pressed, and remains locked until the button is pressed a second time or the exposure meters turn off.
 AF lock only	Focus locks while the Fn button is pressed.
 Flash off	The flash will not fire in photos taken while the Fn button is pressed.



Option	Description
BKT Bracketing burst	If the Fn button is pressed while exposure or flash bracketing is active in single frame release mode, all shots in the current bracketing program will be taken at 5 fps while the shutter-release button is pressed. If white balance bracketing is active or continuous release mode (mode CN or CL) is selected, the camera will repeat the bracketing burst while the shutter-release button is held down.
 Matrix metering	Matrix metering is activated while the Fn button is pressed.
 Center-weighted	Center-weighted metering is activated while the Fn button is pressed.
 Spot metering	Spot metering is activated while the Fn button is pressed.
 Virtual horizon *	The electronic analog exposure displays act as a tilt meter (pg. 335).
 Playback *	The Fn button performs the same function as the  button. Choose when using a long lens or in other situations in which it is difficult to operate the  button with your left hand.
 Access top item in My Menu *	Press the Fn button to jump to the top item in "MY MENU." Select this option for quick access to a frequently-used menu item.
None (default)	No operation is performed when the Fn button is pressed.







* This option can not be used in combination with [FUNC. button+dials] (pg. 336). Selecting this options displays a message and sets [FUNC. button+dials] to [None]. If another option is selected for [FUNC. button+dials] while this setting is active, [FUNC. button press] will be set to [None].

Note that none of these options can be combined with [FUNC. button+dials] > [Dynamic AF area]; see page 336.



Virtual Horizon

When [Virtual horizon] is selected for [FUNC. button press], the electronic analog exposure displays in the viewfinder and top control panel act as a horizontal level when the **Fn** button is pressed.







	Camera tilted right	Camera level	Camera tilted left
Control panel			
Viewfinder			

Note that the display may not be accurate when the camera is tilted at a sharp angle forward or back.



■ ■ FUNC. Button+Dials

Selecting [FUNC. button+dials] for Custom Setting f4 displays the following options:

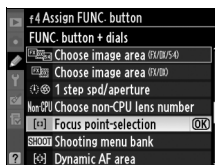
Option	Description
 Choose image area (FX/DX/5:4) (default)	The Fn button and main command dial can be used to select the image area from FX, DX, and 5 : 4 (pg. 60). The image area can not be changed while shooting a multiple exposure (pg. 206).
 Choose image area (FX/DX)	The Fn button and main command dial can be used to switch between FX and DX image areas. The image area can not be changed while shooting a multiple exposure.
 1 step spd/aperture	If the Fn button is pressed when the command dials are rotated, changes to shutter speed (exposure modes S and M) and aperture (exposure modes A and M) are made in increments of 1 EV, regardless of the option selected for Custom Setting b2 ([EV steps for exposure cntrl.], pg. 314).
 Choose non-CPU lens number	Press the Fn button and rotate a command dial to choose a lens number specified using the [Non-CPU lens data] option (pg. 218).
[F1] Focus point-selection	Press the Fn button and rotate the command dials for vertical shooting to choose a focus point (pg. 337).
 Shooting menu bank	If this option is selected, the shooting menu bank can be selected by pressing the Fn button and rotating a command dial.
[F2] Dynamic AF area	When [] (dynamic-area AF) is selected in focus mode C (continuous-servo autofocus), the number of focus points (pg. 307) can be selected by pressing the Fn button and rotating a command dial. The focus points used for dynamic-area AF are displayed in the viewfinder while the Fn button is pressed; if [51 points (3D-tracking)] is selected, "3D" will be displayed in the viewfinder.
None	No operation is performed when the command dials are rotated while the Fn button is pressed.

Portrait (Tall-Orientation) Photographs

To use the command dials to select the focus point when framing shots in portrait (“tall”) orientation:

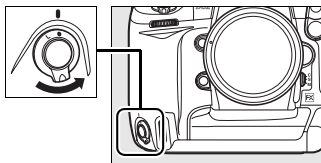
1 Choose [Focus point-selection].

Select [Focus point-selection] for Custom Setting f4 ([Assign FUNC. button]) > [FUNC. button+dials].



2 Unlock the shutter-release button for vertical shooting.

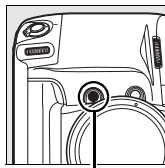
Vertical shutter-release button lock



3 Select the focus point.

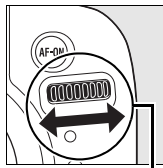
With the camera in portrait (“tall”) orientation, select a focus point by pressing the **Fn** button and rotating the command dials for vertical shooting. Use the main command dial to move the focus area selection left or right, the sub-command dial to move it up or down.

Main command dial for vertical shooting



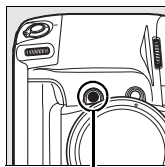
Fn button

+



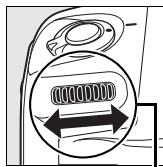
Main command dial
for vertical shooting

Sub-command dial for vertical shooting

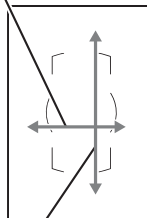


Fn button

+



Sub-command dial
for vertical shooting



f5: Assign Preview Button

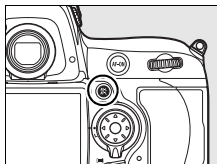
Choose the role played by the depth-of-field preview button, either by itself ([Preview button press]) or when used in combination with the command dials ([Preview + command dials]). The options available are the same as for [FUNC. button press]

(pg. 333) and [FUNC. button+dials] (pg. 336), except that the default option for [Preview button press] is [Preview] and that [Preview + command dials] lacks a [Focus point-selection] option (the default setting for [Preview + command dials] is [None]).



f6: Assign AE-L/AF-L Button

Choose the role played by the **AE-L/AF-L** button, either by itself ([AE-L/AF-L button press]) or when used in combination with the command dials ([AE-L/AF-L+command dials]). The options available for [AE-L/AF-L button press] are the same as for [FUNC.



button press] (pg. 333), except that [AE-L/AF-L button press] defaults to [AE/AF lock] and has an additional **AF-ON** option (if this option is selected, pressing the **AE-L/AF-L** button has the same effect as pressing the **AF-ON** button to initiate autofocus). The options available for [AE-L/AF-L+command dials] are the same as for [FUNC. button+dials] (pg. 336), except that [AE-L/AF-L +command dials] defaults to [None] and lacks [1 step spd/aperture] and [Focus point-selection] options.






f7: Customize Command Dials

This option controls the operation of the main and sub-command dials.

Option	Description
Reverse rotation	Controls the direction of the command dials. Choose [No] (the default option) for normal command dial operation, or [Yes] to reverse the rotation of the command dials. This setting also applies to the command dials for vertical shooting.
Change main/sub	At the default setting of [Off], the main command dial controls shutter speed and the sub-command dial controls aperture. If [On] is selected, the main command dial will control aperture and the sub-command dial shutter speed. If [On (Mode A)] is selected, the main command dial will be used to set aperture in exposure mode A only. This setting also applies to the command dials for vertical shooting.



Option	Description
Aperture setting	At the default setting of [Sub-command dial], aperture can only be adjusted with the sub-command dial (or with the main command dial if [On] is selected for [Change main/sub]). If [Aperture ring] is selected, aperture can only be adjusted with the lens aperture ring and the camera aperture display will show aperture in increments of 1 EV (aperture for type G lenses is still set using the sub-command dial). If [Aperture ring] is selected and a CPU lens with an aperture ring is attached when the mode dial is rotated to  , live view will not start and the shutter release will be disabled. Note that regardless of the setting chosen, the aperture ring must be used to adjust aperture when a non-CPU lens is attached.
Menus and playback	At the default setting of [Off], the multi selector is used to choose the picture displayed during full-frame playback, highlight thumbnails, and navigate menus. If [On] is selected, the main command dial can be used to choose the picture displayed during full-frame playback, move the cursor left or right during thumbnail playback, and move the menu highlight bar up or down. The sub-command dial is used to display additional photo information in full-frame playback and to move the cursor up or down during thumbnail playback. While menus are displayed, rotating the sub-command dial right displays the sub-menu for the selected option, while rotating it left displays the previous menu. To make a selection, press  , the center of the multi selector, or  .

Live View

When using a CPU lens equipped with an aperture ring in live view, select [Sub-command dial] for [Aperture setting].



f8: Release Button to Use Dial

This option allows adjustments that are normally made by holding a button and rotating a command dial to be made by rotating the command dial after the button is released. At the default setting of [No], the button must be pressed while the command dial is rotated. If [Yes] is selected, the setting can be changed by rotating the command dial after the button is released. Setting ends when the button is pressed again, the shutter-release button is pressed halfway, or any of the **MODE**, **☒**, **BKT**, **⚡**, **ISO**, **QUAL**, or **WB** button is pressed. Except when [No limit] is selected for Custom Setting c2 [Auto meter-off delay] or an optional EH-6 AC adapter is used, setting will also end when the exposure meters turn off.



f9: No Memory Card?

At the default setting of [Enable release], the shutter can be released when no memory card is inserted, although no pictures will be recorded (they will however be displayed in the monitor in demo mode). If [Release locked] is selected, the shutter-release button is only enabled when a memory card is inserted in the camera. Note that when photographs are being captured to a computer using Camera Control Pro 2 (available separately), photographs are not recorded to the camera memory card and the shutter will be enabled regardless of the setting chosen for this option.



f10: Reverse Indicators

At the default setting of (+0-), the exposure indicators in the top control panel and shooting information display are displayed with positive values on the left and negative values on the right. Select (-0+) to display negative values on the left and positive values on the right.



Y The Setup Menu: Camera Setup

The setup menu contains the options listed below. For information on using the setup menu, see “Tutorial: Camera Menus” (pg. 26).

Option	See page
Format memory card	347
LCD brightness	347
Lock mirror up for cleaning ¹	400
Video mode	348
HDMI	348
World time	349
Language	349
Image comment	350
Auto image rotation	351
Voice memo	248
Voice memo overwrite	249
Voice memo button	249
Audio output	254
USB	352
Dust off ref photo	353
Battery info	355
Wireless transmitter ²	261
Image authentication	356
Copyright information	357
Save/load settings	358
GPS	221
Virtual horizon	360
Non-CPU lens data	218
AF fine tune	361
Firmware version	362

¹ Not available when battery is low.

² Only available when optional WT-4 wireless transmitter is connected and [MTP/PTP] selected for [USB] (pg. 352).

Format Memory Card

Format the card in the selected slot. *Note that formatting permanently deletes all pictures and other data on the card.* Before formatting, be sure to make backup copies as required.

✔ During Formatting

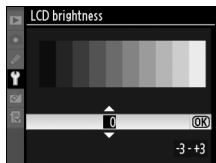
Do not turn the camera off or remove memory cards during formatting.

✎ Two-Button Format

Memory cards can also be formatted by pressing the **FORMAT** (🗑️) and **MODE** buttons for more than two seconds (pg. 45).

LCD Brightness

Press ▲ or ▼ to choose from seven settings for monitor brightness. Choose higher values for increased brightness, lower values for reduced brightness.



✎ See Also

For information on adjusting monitor brightness in live view, see page 99.

Lock Mirror up for Cleaning

Lock the mirror in the up position to allow inspection or manual cleaning of the low-pass filter that protects the camera image sensor (pg. 400).



Video Mode

When connecting the camera to a television or VCR via the A/V out connector, be sure the camera video mode matches the device video standard (NTSC or PAL).

HDMI

The camera is equipped with an HDMI (**H**igh-**D**efinition **M**ultimedia Interface) connector, allowing pictures to be played back on high-definition televisions or monitors using a type A cable (available separately from commercial suppliers). Before connecting the camera to high-definition device, choose the HDMI format from the options below.

Option	Description
AUTO Auto (default)	The camera automatically selects the appropriate format.
480p 480p (progressive)	640 × 480 (progressive) format
576p 576p (progressive)	720 × 576 (progressive) format
720p 720p (progressive)	1,280 × 720 (progressive) format
1080i 1080i (interlaced)	1,920 × 1,080 (interlaced) format

The camera monitor turns off automatically when an HDMI device is connected.



World Time

Change time zones, set the camera clock, choose the date display order, and turn daylight saving time on or off.

Option	Description
Time zone	Choose a time zone. The camera clock is automatically set to the time in the new time zone.
Date and time	Set the camera clock (pg. 40).
Date format	Choose the order in which the day, month, and year are displayed.
Daylight saving time	Turn daylight saving time on or off. The camera clock will automatically be advanced or set back one hour. The default setting is [Off].

Language

Choose a language for camera menus and messages. The following options are available.

De Deutsch	German	Pt Português	Portuguese
En English	English	Ru Русский	Russian
Es Español	Spanish	Sv Svenska	Swedish
Fi Suomi	Finnish	繁 中文(繁體)	Traditional Chinese
Fr Français	French	简 中文(简体)	Simplified Chinese
It Italiano	Italian	日 日本語	Japanese
Nl Nederlands	Dutch	한 한글	Korean
Pl Polski	Polish		

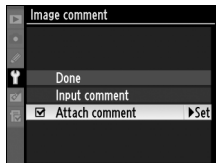


Image Comment

Add a comment to new photographs as they are taken.

Comments can be viewed in ViewNX (supplied) or Capture NX 2 (available separately; pg. 391). The comment is also visible on the third shooting data page in the photo information display.

- [Done]: Save changes and return to the setup menu.
- [Input comment]: Input a comment as described on page 292. Comments can be up to 36 characters long.
- [Attach comment]: Select this option to attach the comment to all subsequent photographs. [Attach comment] can be turned on and off by highlighting it and pressing ►.

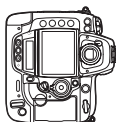


Auto Image Rotation

Photographs taken while [On] (the default option) is selected contain information on camera orientation, allowing them to be rotated automatically during playback (pg. 287) or when viewed in ViewNX (supplied) or Capture NX 2 (available separately; pg. 391). The following orientations are recorded:



Landscape (wide)
orientation



Camera rotated 90°
clockwise



Camera rotated 90°
counter-clockwise

Camera orientation is not recorded when [Off] is selected. Choose this option when taking photographs with the lens pointing up or down.

Rotate Tall

To automatically rotate “tall” (portrait-orientation) photographs for display during playback, select [On] for the [Rotate tall] option in the playback menu (pg. 287). Note that because the camera itself is already in the appropriate orientation during shooting, images are not rotated automatically during image review (pg. 228).

Voice Memo


The voice memo menu contains options for recording voice memos during shooting. See “Voice Memos: Recording Voice Memos” (pg. 248).



Voice Memo Overwrite

This option determines whether the voice memo for the last photograph recorded can be overwritten when the camera is in shooting mode. See “Voice Memos: Recording Voice Memos” (pg. 249).

Voice Memo Button

This option controls the operation of the  button. See “Voice Memos: Recording Voice Memos” (pg. 249).

Audio Output

Choose output options for voice memo playback. See “Voice Memos: Playing Voice Memos” (pg. 254).

USB

Choose a USB option for connection to a computer or PictBridge printer. Choose [MTP/PTP] (the default setting) when connecting to a PictBridge printer or an optional WT-4 wireless transmitter or when using Camera Control Pro 2 (available separately; see page 391). See page 257 for information on selecting a USB option for use with Nikon Transfer (supplied).



Dust off Ref Photo

Acquire reference data for the Image Dust Off option in Capture NX 2 (available separately; for more information, see the software manual).

[Dust off ref photo] is available only when a CPU lens is mounted on the camera. A non-DX lens with a focal length of at least 50 mm is recommended. When using a zoom lens, zoom all the way in.

1 Select [Start].

Highlight [Start] and press **OK**.



The message shown at right will be displayed and “rEF” will appear in the viewfinder and top control panel. To exit without acquiring image dust off data, press **MENU**.



2 Frame a featureless white object in the viewfinder.

With the lens about ten centimeters (four inches) from a well-lit, featureless white object, frame the object so that it fills the viewfinder and then press the shutter-release button halfway.

In autofocus mode, focus will automatically be set to infinity; in manual focus mode, set focus to infinity manually.



3 Acquire dust off reference data.

Press the shutter-release button the rest of the way down to acquire Image Dust Off reference data. The monitor turns off when the shutter-release button is pressed.

If the reference object is too bright or too dark, the camera may be unable to acquire Image Dust Off reference data and the message shown at right will be displayed. Choose another reference object and repeat the process from step 1.



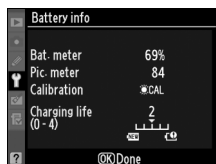
✔ Image Dust Off Reference Data

The same reference data can be used for photographs taken with different lenses or at different apertures. Reference images can not be viewed using computer imaging software. A grid pattern is displayed when reference images are viewed on the camera; histograms and highlights are not displayed.



Battery Info

View information on the battery currently inserted in the camera.




Item	Description
Bat. meter	The current battery level expressed as a percentage.
Pic. meter	The number of times the shutter has been released with the current battery since the battery was last charged. Note that the camera may sometimes release the shutter without recording a photograph, for example when measuring preset white balance.
Calibration	<ul style="list-style-type: none">• [CAL]: Due to repeated use and recharging, calibration is required to ensure that battery level can be measured accurately; recalibrate battery before charging (pg. 437).• [—]: Calibration not required.
Charging life	A five-level display showing battery age. 0 () indicates that battery performance is unimpaired, 4 () that the battery has reached the end of its charging life and should be replaced. Note that batteries charged at temperatures under about 5 °C (41 °F) may show a temporary drop in charging life; the charging life display will however return to normal once the battery has been recharged at a temperature of about 20 °C (68 °F) or higher.




Wireless Transmitter

This option is used to adjust settings for connection to a wireless network, using an optional WT-4 wireless transmitter. See “Connections: Wireless and Ethernet Networks” (pg. 261).

Image Authentication

Choose whether to embed image authentication information in new photographs as they are taken, allowing alterations to be detected using Nikon’s optional Image Authentication software. Image authentication information can not be embedded in existing photographs. Photographs taken with image authentication on are marked with a  icon on the file information and overview data pages of the photo information display (pp. 230, 240).

Option	Description
 On	Image authentication information embedded in new photographs as they are taken.
Off (default)	Image authentication information not embedded in new photographs.

Camera Control Pro 2

Image authentication information is not embedded in TIFF (RGB) photographs recorded directly to a computer using Camera Control Pro 2 (available separately).

Copies

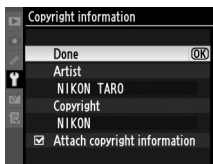
Image authentication information is not embedded in copies created using the options in the retouch menu (pg. 363).



Copyright Information

Add copyright information to new photographs as they are taken. Copyright information is visible on the fourth shooting data page in the photo information display (pg. 237) and can be viewed using ViewNX (supplied) or Capture NX 2 (available separately; pg. 391).

- [Done]: Save changes and return to the setup menu.
- [Artist]: Enter a photographer name as described on page 292. Photographer names can be up to 36 characters long.
- [Copyright]: Enter the name of the copyright holder as described on page 292. Copyright holder names can be up to 54 characters long.
- [Attach copyright information]: Select this option to attach copyright information to all subsequent photographs. [Attach copyright information] can be turned on and off by highlighting it and pressing ►.



✔ Copyright Information

To prevent unauthorized use of the artist or copyright holder names, make sure that [Attach copyright information] is not selected and that the [Artist] and [Copyright] fields are blank before lending or transferring the camera to another person. Nikon does not accept liability for any damages or disputes arising from the use of the [Copyright information] option.



Save/Load Settings

Select [Save settings] to save the following settings to the memory card in slot 1 (if the memory card is full, an error will be displayed; pg 417).

Menu	Option
Playback	Display mode
	Image review
	After delete
	Rotate tall
Shooting (all banks)	Shooting menu bank
	File naming
	Slot 2
	Image quality
	Image size
	Image area
	JPEG compression
	NEF (RAW) recording
	White balance (with fine tuning and presets d-0–d-4)
	Set Picture Control
	Color space
	Active D-Lighting
	Vignette control
	Long exp. NR
	High ISO NR
ISO sensitivity settings	
Live view	
Custom settings (all banks)	All Custom Settings except [Reset custom settings]



Menu	Option
Setup	Video mode
	HDMI
	World time (excepting date and time)
	Language
	Image comment
	Auto image rotation
	Voice memo
	Voice memo overwrite
	Voice memo button
	Audio output
	USB
	Image authentication
	Copyright information
	GPS
Non-CPU lens data	
My Menu/ Recent Settings	All My Menu items
	All recent settings
	Choose tab

Settings saved using the D3X can be restored by selecting [Load settings]. Note that [Save/load settings] is only available when a memory card is inserted in slot 1, and that the [Load settings] option is only available if the card in slot 1 contains saved settings (the memory card in slot 2 can not be used to save or load settings).

Saved Settings

Settings are saved in a file named NCSETUP3. The camera will not be able to load settings if the file name is changed.



GPS

Adjust settings for connection to a GPS unit (pg. 221).

Virtual Horizon

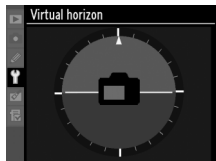
Display a virtual horizon based on information from the camera orientation sensor.

Tilting the Camera

The virtual horizon display is not accurate when the camera is tilted at a sharp angle forward or back.

See Also

For information on using the electronic analog exposure displays as a tilt meter, see Custom Setting f4 ([Assign FUNC. button] > [FUNC. button press]; pg. 334). For information on displaying a virtual horizon in live view, see page 99.



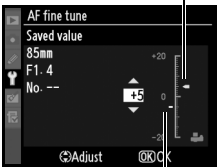
Non-CPU Lens Data

By specifying lens data (lens focal length and maximum aperture) for up to nine non-CPU lenses, the user can gain access to a variety of CPU lens functions (pg. 218).










AF Fine Tune

Fine-tune focus for up to 20 lens types. AF tuning is not recommended in most situations; use only when required.

Option	Description
AF fine tune (On/Off)	<ul style="list-style-type: none">• [On]: Turn AF tuning on.• [Off] (default): Turn AF tuning off.
Saved value	<p>Tune AF for the current lens (CPU lenses only). Press ▲ or ▼ to choose a value between +20 and -20. Values for up to 20 lens types can be stored. Only one value can be stored for each type of lens.</p> <p>Move focal point away from camera. Current value</p> 
Default	<p>Choose the AF tuning value used when no previously saved value exists for the current lens (CPU lenses only).</p> <p>Move focal point toward camera. Previous value</p>



Option	Description
<p>List saved values</p>	<p>List previously saved AF tuning values. If a value exists for the current lens, it will be shown with a  icon. To delete a lens from the list, highlight the desired lens and press . To change a lens identifier (for example, to choose an identifier that is the same as the last two digits of the lens serial number to distinguish it from other lenses of the same type in light of the fact that [Saved value] can be used with only one lens of each type), highlight the desired lens and press .</p> <p>The menu shown at right will be displayed; press  or  to choose an identifier and press  to save changes and exit.</p> 

AF Tuning

The camera may be unable to focus at minimum range or at infinity when AF tuning is applied.

Live View (Tripod) Mode

Tuning is not applied to contrast-detect autofocus when [Tripod] is selected in live view mode (pg. 94).

Saved Value

Only one value can be stored for each type of lens. If a teleconverter is used, separate values can be stored for each combination of lens and teleconverter.









Firmware Version

View the current camera firmware version.



The Retouch Menu: Creating Retouched Copies

The options in the retouch menu are used to create trimmed, or retouched copies of the photographs on the memory card. The retouch menu is only displayed when a memory card containing photographs is inserted in the camera. For information on using the shooting menu, see “Tutorial: Camera Menus” (pg. 26).

Option	See page
 D-Lighting *	366
 Red-eye correction *	367
 Trim	368
 Monochrome *	369
 Filter effects *	370
 Color balance *	370
 Image overlay	371
 Side-by-side comparison	374

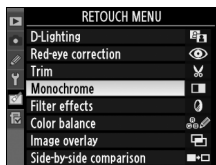
* Not available with photographs taken with [Monochrome] selected for [Set Picture Control] (pg. 164).




Creating Retouched Copies

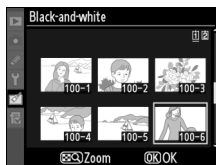
1 Select an item in the retouch menu.



Press ▲ or ▼ to highlight an item, ► to select. Depending on the option selected, a menu may be displayed; highlight an option and press ►.

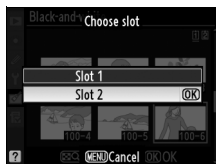


2 Select a picture.


The pictures on the memory card will be displayed. Use the multi selector to highlight a picture (to view the highlighted picture full screen, press and hold the  button).

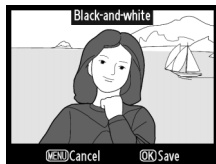


If two memory cards are inserted, the slot can be selected by holding the  button and pressing ▲. The menu shown at right will be displayed (pg. 228); highlight the desired slot and press .




3 Display retouch options.

Press  to display retouch options (see the section for the selected option for details). To exit without creating a retouched copy, press **MENU**.



4 Create a retouched copy.

Press **OK** to create a retouched copy. Retouched copies are indicated by a  icon.



Retouching Copies

Copies created with [Trim] can not be further modified. D-lighting, red-eye correction, filter effects, and color balance can not be applied to monochrome copies. Otherwise the options in the retouch menu can each be applied once to existing copies, although this may result in loss of detail.

Image Quality

Except in the case of copies created with [Trim] (pg. 369) and [Image overlay], copies created from JPEG images are the same size and quality as the original, copies created from NEF (RAW) photos are saved as large fine-quality JPEG images, and copies created from TIFF (RGB) photos are saved as fine-quality JPEG images of the same size as the original. Size-priority compression is used when copies are saved in JPEG format.



D-Lighting

D-Lighting brightens shadows, making it ideal for dark or backlit photographs.

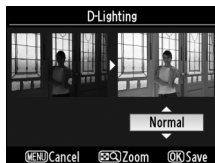


Before



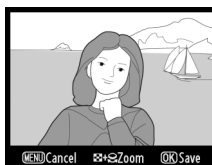
After

Press ▲ or ▼ to choose the amount of correction performed. The effect can be previewed in the edit display. Press Ⓞ to copy the photograph.



Red-Eye Correction

This option is used to correct “red-eye” caused by the flash and is available only with photographs taken using the flash. The photograph selected for red-eye correction is previewed as shown at right. Confirm the effects of red-eye correction and create a



copy as described in the following table. Note that red-eye correction may not always produce the expected results and may in very rare circumstances be applied to portions of the image that are not affected by red-eye; check the preview thoroughly before proceeding.

To	Use	Description
Zoom in		Press button and rotate main command dial right to zoom in, left to zoom out. While photo is zoomed in, press and use multi selector to view areas of image not visible in monitor. Keep multi selector pressed to scroll rapidly to other areas of frame. While button is pressed, area currently visible in monitor is indicated by yellow border. Press to cancel zoom.
Zoom out		
View other areas of image		
Cancel zoom		
Create copy		



Trim

Create a cropped copy of the selected photograph. The selected photograph is displayed with the selected crop shown in yellow; create a cropped copy as described in the following table.



To	Use	Description
Reduce size of crop		Press button and rotate main command dial right to reduce the size of the crop.
Increase size of crop		Press button and rotate main command dial left to increase the size of the crop.
Change crop aspect ratio		Rotate the main command dial to switch between aspect ratios of 3 : 2, 4 : 3, and 5 : 4.
Move crop		Use multi selector to move crop to other area of image.
Preview crop		Press center of multi selector to preview cropped image.
Create copy		Save the current crop as a separate file.



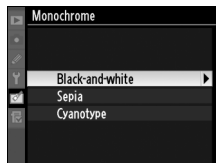
Trim: Image Quality and Size

Copies created from NEF (RAW), NEF (RAW) + JPEG, or TIFF (RGB) photos have an image quality (pg. 66) of JPEG fine; cropped copies created from JPEG photos have the same image quality as the original. The size of the copy varies with crop size and aspect ratio.

Aspect ratio	Possible sizes
3 : 2	4,864 × 3,240, 3,424 × 2,280, 2,560 × 1,704, 1,920 × 1,280, 1,280 × 856, 960 × 640, 640 × 424
4 : 3	4,864 × 3,648, 3,424 × 2,568, 2,560 × 1,920, 1,920 × 1,440, 1,280 × 960, 960 × 720, 640 × 480
5 : 4	4,560 × 3,648, 3,216 × 2,568, 2,400 × 1,920, 1,808 × 1,440, 1,200 × 960, 896 × 720, 608 × 480

Monochrome

Copy photographs in [Black-and-white], [Sepia], or [Cyanotype] (blue and white monochrome).

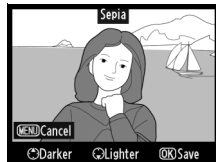


Selecting [Sepia] or [Cyanotype] displays a preview of the selected image; press ▲ to increase color saturation, ▼ to decrease. Press **OK** to create a monochrome copy.

Increase saturation



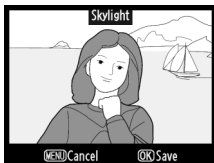
Decrease saturation



Filter Effects

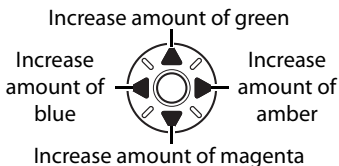
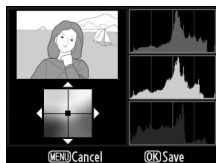
Choose from the following color filter effects. After adjusting filter effects as described below, press **OK** to copy the photograph.

Option	Description
Skylight	Creates the effect of a skylight filter, making the picture less blue. The effect can be previewed in the monitor as shown at right.
Warm filter	Creates a copy with warm tone filter effects, giving the copy a “warm” red cast. The effect can be previewed in the monitor.



Color Balance

Use the multi selector to create a copy with modified color balance as shown below. The effect is displayed in the monitor together with red, green, and blue histograms (pg. 232) giving the distribution of tones in the copy. Press **OK** to copy the photograph.



Creating JPEG Copies of NEF (RAW) Pictures

To create a JPEG copy of an NEF (RAW) picture, select the NEF (RAW) picture for [Color balance] and press **OK** without modifying color balance. The JPEG copy will have an image quality of “fine” and a size of [L].



Image Overlay

Image overlay combines two existing NEF (RAW) photographs to create a single picture that is saved separately from the originals with results that are noticeably better than photographs combined in an imaging application because they make use of RAW data from the camera image sensor. The new picture is saved at current image quality and size settings; before creating an overlay, set image quality and size (pp. 66, 70; all options are available). To create a NEF (RAW) copy, choose an image quality of [NEF (RAW)].

1 Select [Image overlay].

Highlight [Image overlay] in the retouch menu and press **▶**. The dialog shown at right will be displayed, with [Image 1] highlighted.



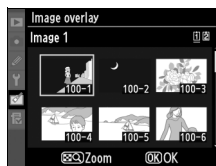
2 Display NEF (RAW) images.

Press **OK**. A picture selection dialog will be displayed.



3 Highlight a photograph.

Press **▲▼◀▶** or **▶** to highlight the first photograph in the overlay. To view the highlighted photograph full frame, press and hold the **🔍** button.



4 Select the highlighted photograph.

Press **OK** to select the highlighted photograph and return to the preview display. The selected image will appear as [Image 1].



5 Set gain.

Optimize exposure for the overlay by pressing **▲** or **▼** to select the gain for image 1 from values between 0.1 and 2.0. The default value is 1.0; selecting 0.5 cuts gain in half, while selecting 2.0 doubles gain. The effects of gain are visible in the [Preview] column.



6 Select the second photograph.

Press **◀** or **▶** to highlight [Image 2]. Repeat Steps 2–5 to select the second photo and adjust gain.



7 Highlight the [Preview] column.

Press **◀** or **▶** to highlight the [Preview] column.



8 Preview the overlay.

Press ▲ or ▼ to highlight [Overlay] and press **OK** (to save the overlay without displaying a preview, highlight [Save] and press **OK**). To return to Step 7 and select new photos or adjust gain, press **Q**.

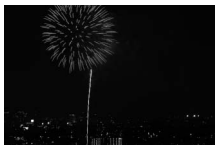


9 Save the overlay.

Press **OK** while the preview is displayed to save the overlay. After an overlay is created, the resulting image will be displayed full-frame in the monitor.



+



✓ Image Overlay

Only NEF (RAW) photographs created with the D3X can be selected for image overlay. Other images are not displayed in the selection screen. Only NEF (RAW) photographs with the same image area and bit-depth can be combined.

The overlay has the same photo info (including date of recording, metering, shutter speed, aperture, exposure mode, exposure compensation, focal length, and image orientation) and values for white balance and picture control as the photograph selected for [Image 1]. Overlays saved in NEF (RAW) format use the compression selected for [Type] in the [NEF (RAW) recording] menu and have the same bit depth as the original images; JPEG overlays are saved using size-priority compression.

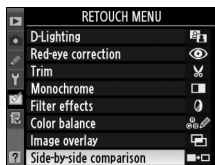


Side-by-Side Comparison



Compare retouched copies to the original photographs.

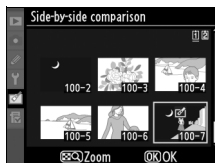
1 Select [Side-by-side comparison].

Highlight [Side-by-side comparison] and press **▶** to display a picture-selection dialog.





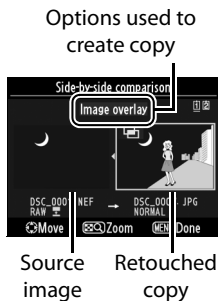
2 Select a picture.

Use the multi selector to highlight a picture and press **OK**. Only retouched copies (shown by a ) or photographs that have been retouched can be selected. To view the highlighted photograph full frame, press and hold the  button.



3 Compare the copy with the original.

The source image is displayed on the left, the retouched copy on the right, with the options used to create the copy listed at the top of the display. Press the multi selector in the direction indicated by the arrow adjacent to the highlighted image (▲ ▼ ◀ or ▶) to switch between the source image and the retouched copy. To view the highlighted picture full frame, press and hold the  button. If the copy was created from two images using [Image overlay], press ▲ or ▼ to view the other source image. To exit to playback mode, press the MENU button. To return to Step 2 with the highlighted image selected, press  or the center of the multi selector.



Side-by-Side Comparison

The source image will not be displayed if the copy was created from a photograph that has since been deleted, is currently protected (pg. 244) or hidden (pg. 281), or contains embedded image authentication information (pg. 356).




My Menu: Creating a Custom Menu

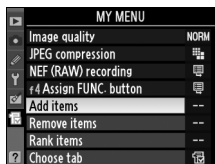
The [My Menu] option can be used to create and edit a customized list of options from the playback, shooting, Custom Settings, setup, and retouch menus for quick access (up to 20 items). If desired, recent settings can be displayed in place of My Menu (pg. 380).

Options can be added, deleted, and reordered as described below. For information on basic menu operations, see “Tutorial: Camera Menus” (pg. 26).

Adding Options to My Menu

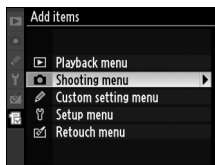
1 Select [Add items].

In My Menu () , highlight [Add items] and press ►




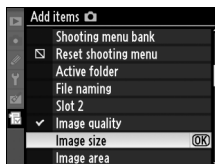
2 Select a menu.

Highlight the name of the menu containing the option you wish to add and press ►.



3 Select an item.

Highlight the desired menu item and press .



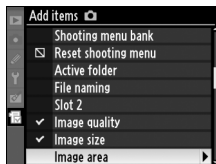
4 Position the new item.

Press ▲ or ▼ to move the new item up or down in My Menu. Press **OK** to add the new item.



5 Add more items.

The items currently displayed in My Menu are indicated by a check mark. Items indicated by a icon can not be selected. Repeat steps 1–4 to select additional items.



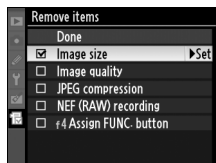
Deleting Options from My Menu

1 Select [Remove items].

In My Menu (MENU), highlight [Remove items] and press ►.

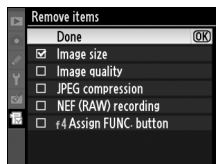
2 Select items.

Highlight items and press ► to select or deselect. Selected items are indicated by a check mark.



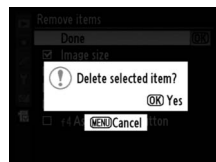
3 Select [Done].

Highlight [Done] and press OK. A confirmation dialog will be displayed.



4 Delete the selected items.

Press OK to delete the selected items.



Deleting Items in My Menu

To delete the item currently highlighted in My Menu, press the MENU button. A confirmation dialog will be displayed; press MENU again to remove the selected item from My Menu.

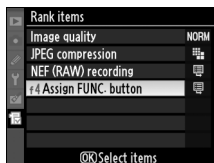
Reordering Options in My Menu

1 Select [Rank items].

In My Menu (M), highlight [Rank items] and press ►.

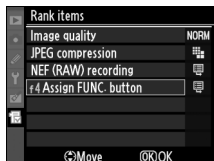
2 Select an item.

Highlight the item you wish to move and press OK.





3 Position the item.

Press ▲ or ▼ to move the item up or down in My Menu and press OK. Repeat Steps 2–3 to reposition additional items.



Reordering Items in My Menu

The item currently highlighted in My Menu can be moved up or down by pressing the  button and pressing ▲ or ▼. Release the  button when the operation is complete.

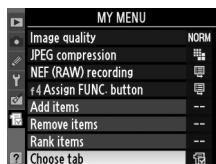


Displaying Recent Settings

To display the twenty most recently used settings, select [Recent settings] for [My Menu] > [Choose tab].

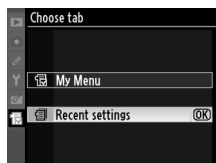
1 Select [Choose tab].

In My Menu (☰), highlight [Choose tab] and press ►.



2 Select [Recent Settings].

Highlight [Recent settings] and press OK. The name of the menu will change from “MY MENU” to “RECENT SETTINGS.”



Menu items will be added to the top of the recent settings menu as they are used. To view My Menu again, select [My Menu] for [Recent settings] > [Choose tab].





Technical Notes



– *Camera Care, Options, and Resources*

This chapter covers the following topics:

Compatible Lenses	pg. 382
Other Accessories	pg. 387
Caring for the Camera	pg. 395
Storage	pg. 395
Cleaning.....	pg. 395
Replacing the Focusing Screen	pg. 396
Replacing the Clock Battery.....	pg. 398
The Low-Pass Filter.....	pg. 400
Caring for the Camera and Battery: Cautions	pg. 403
Troubleshooting	pg. 407
Error Messages	pg. 414
Appendix	pg. 421
Specifications	pg. 431



Compatible Lenses

Camera setting Lens/accessory		Focus mode			Exposure mode		Metering system		
		S C	M (with electronic rangefinder)	M	P S	A M			
							3D	Color	
CPU lenses ¹¹	Type G or D AF Nikkor ² AF-S, AF-I Nikkor	✓	✓	✓	✓	✓	✓	—	✓ ³
	PC-E NIKKOR series	—	✓ ⁵	✓	✓ ⁵	✓ ⁵	✓ ⁵	—	✓ ^{3,5}
	PC Micro 85mm f/2.8D ⁴	—	✓ ⁵	✓	—	✓ ⁶	✓	—	✓ ³
	AF-S / AF-I Teleconverter ⁷	✓ ⁸	✓ ⁸	✓	✓	✓	✓	—	✓ ³
	Other AF Nikkor (except lenses for F3AF)	✓ ⁹	✓ ⁹	✓	✓	✓	—	✓	✓ ³
	AI-P Nikkor	—	✓ ¹⁰	✓	✓	✓	—	✓	✓ ³
Non-CPU lenses ¹¹	AI-, AI-modified, Nikkor or Nikon Series E lenses ¹²	—	✓ ¹⁰	✓	—	✓ ¹³	—	✓ ¹⁴	✓ ¹⁵
	Medical-Nikkor 120mm f/4	—	✓	✓	—	✓ ¹⁶	—	—	—
	Reflex-Nikkor	—	—	✓	—	✓ ¹³	—	—	✓ ¹⁵
	PC-Nikkor	—	✓ ⁵	✓	—	✓ ¹⁷	—	—	✓
	AI-type Teleconverter ¹⁸	—	✓ ⁸	✓	—	✓ ¹³	—	✓ ¹⁴	✓ ¹⁵
	PB-6 Bellows Focusing Attachment ¹⁹	—	✓ ⁸	✓	—	✓ ²⁰	—	—	✓
Auto extension rings (PK-series 11A, 12, or 13; PN-11)	—	✓ ⁸	✓	—	✓ ¹³	—	—	✓	

1 IX-Nikkor lenses can not be used.

2 Vibration Reduction (VR) supported with VR lenses.

3 Spot metering meters selected focus point.

4 The camera's exposure metering and flash control systems do not work properly when shifting and/or tilting the lens, or when an aperture other than the maximum aperture is used.

5 Electronic rangefinder can not be used with shifting or tilting.

6 Manual exposure mode only.

7 Can be used with AF-S and AF-I lenses only (pg. 385).

8 With maximum effective aperture of f/5.6 or faster.

- 9 When focusing at minimum focus distance with AF 80–200mm f/2.8, AF 35–70mm f/2.8, AF 28–85mm f/3.5–4.5 <New>, or AF 28–85mm f/3.5–4.5 lens at maximum zoom, in-focus indicator may be displayed when image on matte screen in viewfinder is not in focus. Adjust focus manually until image in viewfinder is in focus.
 - 10 With maximum aperture of f/5.6 or faster.
 - 11 Some lenses can not be used (see page 384).
 - 12 Range of rotation for AI 80–200mm f/2.8 ED tripod mount is limited by camera body. Filters can not be exchanged while AI 200–400mm f/4 ED is mounted on camera.
 - 13 If maximum aperture is specified using [Non-CPU lens data] (pg. 218), aperture value will be displayed in viewfinder and top control panel.
 - 14 Can be used only if lens focal length and maximum aperture are specified using [Non-CPU lens data] (pg. 218). Use spot or center-weighted metering if desired results are not achieved.
 - 15 For improved precision, specify lens focal length and maximum aperture using [Non-CPU lens data] (pg. 218).
 - 16 Can be used in manual exposure modes at shutter speeds slower than $1/125$ s.
 - 17 Exposure determined by presetting lens aperture. In aperture-priority auto exposure mode, preset aperture using lens aperture ring before performing AE lock and shifting lens. In manual exposure mode, preset aperture using lens aperture ring and determine exposure before shifting lens.
 - 18 Exposure compensation required when used with AI 28–85mm f/3.5–4.5, AI 35–105mm f/3.5–4.5, AI 35–135mm f/3.5–4.5, or AF-S 80–200mm f/2.8D. See teleconverter manual for details.
 - 19 Requires PK-12 or PK-13 auto extension ring. PB-6D may be required depending on camera orientation.
 - 20 Use preset aperture. In aperture-priority auto exposure mode, set aperture using focusing attachment before determining exposure and taking photograph.
- PF-4 Reprocopy Outfit requires PA-4 Camera Holder.



❑ Incompatible Accessories and Non-CPU Lenses

The following accessories and non-CPU lenses can NOT be used with the D3X:

- TC-16AS AF teleconverter
- Non-AI lenses
- Lenses that require the AU-1 focusing unit (400mm f/4.5, 600mm f/5.6, 800mm f/8, 1200mm f/11)
- Fisheye (6mm f/5.6, 7.5mm f/5.6, 8mm f/8, OP 10mm f/5.6)
- 2.1cm f/4
- Extension Ring K2
- 180–600mm f/8 ED (serial numbers 174041–174180)
- 360–1200mm f/11 ED (serial numbers 174031–174127)
- 200–600mm f/9.5 (serial numbers 280001–300490)
- AF lenses for the F3AF (AF 80mm f/2.8, AF 200mm f/3.5 ED, AF Teleconverter TC-16)
- PC 28mm f/4 (serial number 180900 or earlier)
- PC 35mm f/2.8 (serial numbers 851001–906200)
- PC 35mm f/3.5 (old type)
- Reflex 1000mm f/6.3 (old type)
- Reflex 1000mm f/11 (serial numbers 142361–143000)
- Reflex 2000mm f/11 (serial numbers 200111–200310)

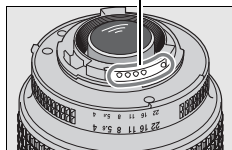
✎ Lens f-number

The f-number given in lens names is the maximum aperture of the lens.

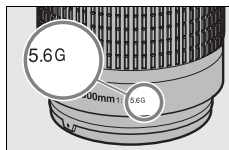
✎ Recognizing CPU and Type G and D Lenses

CPU lenses can be identified by the presence of CPU contacts, type G and D lenses by a letter on the lens barrel. Type G lenses are not equipped with a lens aperture ring.

CPU contacts

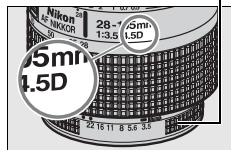


CPU lens



Type G lens

Aperture ring



Type D lens



The AF-S/AF-I Teleconverter

The AF-S/AF-I teleconverter can be used with the following AF-S and AF-I lenses:

- AF-S VR Micro 105mm f/2.8G ED¹
- AF-S VR 200mm f/2G ED
- AF-S VR 300mm f/2.8G ED
- AF-S 300mm f/2.8D ED II
- AF-S 300mm f/2.8D ED
- AF-I 300mm f/2.8D ED
- AF-S 300mm f/4D ED²
- AF-S 400mm f/2.8D ED II
- AF-S 400mm f/2.8D ED
- AF-I 400mm f/2.8D ED
- AF-S 500mm f/4D ED II²
- AF-S 500mm f/4D ED²
- AF-I 500mm f/4D ED²
- AF-S 600mm f/4D ED II²
- AF-S 600mm f/4D ED²
- AF-I 600mm f/4D ED²
- AF-S VR 70–200mm f/2.8G ED
- AF-S 80–200mm f/2.8D ED
- AF-S VR 200–400mm f/4G ED²
- AF-S NIKKOR 400mm f/2.8G ED VR
- AF-S NIKKOR 500mm f/4G ED VR²
- AF-S NIKKOR 600mm f/4G ED VR²

1 Autofocus not supported.

2 Autofocus not supported when used with AF-S Teleconverter TC-17E II/TC-20E II.

Compatible Non-CPU Lenses

If lens data are specified using [Non-CPU lens data] (pg. 218), many of the features available with CPU lenses can also be used with non-CPU lenses. If lens data are not specified, color matrix metering can not be used, and center-weighted metering is used when matrix metering is selected.

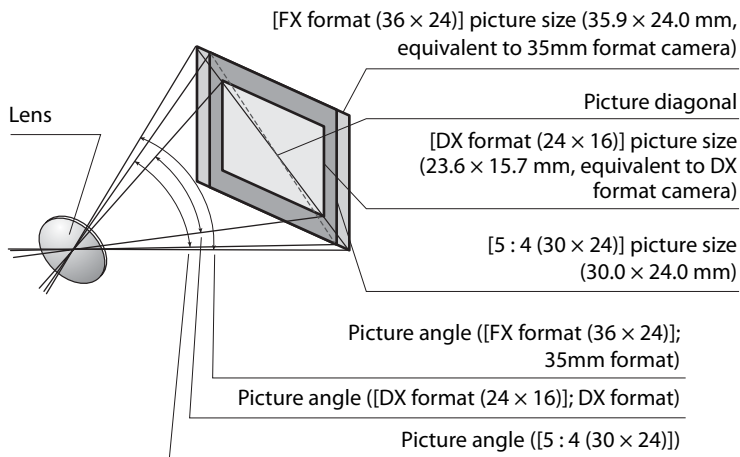
Non-CPU lenses can only be used in exposure modes **A** and **M**, when aperture must be set using the lens aperture ring. If the maximum aperture has not been specified using [Non-CPU lens data], the camera aperture display will show the number of stops from maximum aperture; the actual aperture value must be read off the lens aperture ring. Aperture-priority auto will be selected automatically in exposure modes **P** and **S**. The exposure-mode indicator (**P** or **S**) in the top control panel will blink, and **A** will be displayed in the viewfinder.



Picture Angle and Focal Length

The D3X can be used with Nikon lenses for 35mm (135) format cameras. If [Auto DX crop] is on (the default setting) and a 35mm format lens is attached, the picture angle will be the same as a frame of 35mm film (35.9×24.0 mm); if a DX lens is attached, the picture angle will automatically be adjusted to 23.6×15.7 mm (DX format).

To choose a picture angle different from that of the current lens, turn [Auto DX crop] off and select from [FX format (36×24)], [DX format (24×16)], and [5 : 4 (30×24)]. If a 35mm format lens is attached, the picture angle could be reduced by 1.5 \times by selecting [DX format (24×16)], exposing a smaller area, or the aspect ratio could be changed by selecting [5 : 4 (30×24)].



The [DX format (24×16)] picture angle is about 1.5 times smaller than the 35mm format picture angle, while the [5 : 4 (30×24)] picture angle is about 1.1 times smaller. To calculate the focal length of lenses in 35mm format when [DX format (24×16)] is selected, multiply the focal length of the lens by about 1.5, or by about 1.1 when [5 : 4 (30×24)] is selected (for example, the effective focal length of a 50mm lens in 35mm format would be 75 mm when [DX format (24×16)] is selected, or 55 mm when [5 : 4 (30×24)] is selected).

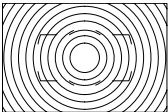
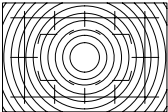
Other Accessories

At the time of writing, the following accessories were available for the D3X.

Power sources	<ul style="list-style-type: none">• Rechargeable Li-ion Battery EN-EL4a, EN-EL4 (pp. 32, 34): Additional EN-EL4a/EN-EL4 batteries are available from local retailers and Nikon service representatives. These batteries can be recharged and calibrated using an MH-22 or MH-21 quick charger.• Quick Charger MH-22, MH-21 (pp. 32, 437): The MH-22, MH-21 can be used to recharge and calibrate EN-EL4a and EN-EL4 batteries.• AC Adapter EH-6: The EH-6 can be used to power the camera for extended periods.
Wireless LAN adapters	<ul style="list-style-type: none">• Wireless Transmitter WT-4: Connects the camera to wireless and Ethernet networks. The photographs on the camera memory card can be viewed by computers on the same network or copied to a computer for long-term storage. The camera can also be controlled from any computer on the network using Camera Control Pro 2 (available separately). Note that the WT-4 requires an independent power source; an EH-6 AC adapter or an EN-EL3e battery is recommended. See the WT-4 manual for details.



- **Focusing Screens** (pg. 396): The focusing screens available for the D3X are listed below.

Type B Brite View clear-matte VI focusing screen		A type B focusing screen is supplied with the camera.
Type E clear-matte VI focusing screen		Type E focusing screens are etched with a grid, making them suitable for copying and architectural photography. Best results are achieved with PC-Nikkor lenses.

- **Magnifier DG-2:** The DG-2 magnifies the scene displayed in the viewfinder. Use for close-up photography, copying, telephoto lenses, and other tasks that call for added precision. DK-18 eyepiece adapter (available separately) required.
- **Antifog Finder Eyepiece DK-14, DK-17A:** These viewfinder eyepieces prevent fogging in humid or cold conditions. The DK-17A is equipped with a safety lock.
- **Rubber Eyepiece Cup DK-19:** The DK-19 makes the image in the viewfinder easier to see, preventing eye fatigue.



**Viewfinder
eyepiece
accessories**

- **Dioptr-adjustment viewfinder lenses:** To accommodate individual differences in vision, viewfinder lenses are available with diopters of -3 , -2 , 0 , $+1$, and $+2 \text{ m}^{-1}$ (values with camera diopter control centered at -1 m^{-1}). Use diopter adjustment lenses only if the desired focus can not be achieved with the built-in diopter adjustment control (-3 to $+1 \text{ m}^{-1}$). Test diopter adjustment lenses before purchase to ensure that the desired focus can be achieved. The DK-17C is equipped with a safety lock.
- **Magnifying Eyepiece DK-17M:** The DK-17M magnifies the view through the viewfinder by approximately $1.2 \times$ for greater precision when framing.
- **Right-Angle Magnifying Viewing Attachment DR-5/Right-Angle Viewing Attachment DR-4:** The DR-5 and DR-4 attach to the viewfinder eyepiece at a right angle, allowing the image in the viewfinder to be viewed from above when the camera is in the horizontal shooting position. The DR-5 can also magnify the view through the viewfinder by $2 \times$ for greater precision when framing (note that the edges of the frame will not be visible when the view is magnified).
- **Eyepiece Adapter DK-18:** The DK-18 is used when attaching the DG-2 Magnifier or DR-3 Right-Angle Viewing Attachment to the D3X.



Filters	<ul style="list-style-type: none"> • Nikon filters can be divided into three types: screw-in, slip-in, and rear-interchange. Use Nikon filters; filters manufactured by other makers may interfere with autofocus or electronic range finding. • The D3X can not be used with linear polarizing filters. Use the C-PL circular polarizing filter instead. • Use NC and L37C filters to protect the lens. • To prevent moiré, use of a filter is not recommended when the subject is framed against a bright light, or when a bright light source is in the frame. • Center-weighted metering is recommended with filters with exposure factors (filter factors) over 1 × (Y44, Y48, Y52, O56, R60, X0, X1, C-PL, ND2S, ND4, ND4S, ND8, ND8S, ND400, A2, A12, B2, B8, B12).
Optional flash units	<ul style="list-style-type: none"> • Nikon Speedlights SB-900, SB-800, SB-600, and SB-400 • Nikon Wireless Remote Speedlight SB-R200 (Controlled remotely using the SB-900, SB-800 flash unit or SU-800 wireless Speedlight commander.) • Wireless Speedlight Commander SU-800 See page 187 for more information.
Water guards	<ul style="list-style-type: none"> • Water Guard WG-AS1: The optional WG-AS1 is a water guard that covers the base of SB-900 flash units mounted on the D3X, increasing the SB-900's splash resistance by protecting the accessory shoe contacts from rain and spray.
PC card adapters	<ul style="list-style-type: none"> • EC-AD1 PC Card Adapter: The EC-AD1 PC card adapter allows Type I CompactFlash memory cards to be inserted in PCMCIA card slots.

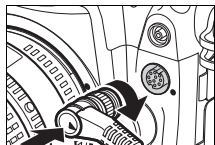


Software	<ul style="list-style-type: none">• Capture NX 2: A complete photo editing package with such advanced editing features as selection control points and an auto retouch brush.• Camera Control Pro 2: Control the camera remotely from a computer and save photographs directly to the computer hard disk.• Image Authentication: Determine whether photographs taken with image authentication on have been modified after shooting. <p>Note: Use the latest versions of Nikon software. Most Nikon software offers an auto update feature when the computer is connected to the Internet.</p>
Body cap	<ul style="list-style-type: none">• Body Cap BF-1A: The BF-1A keeps the mirror, viewfinder screen, and low-pass filter free of dust when a lens is not in place.



Remote terminal accessories

The D3X is equipped with a ten-pin remote terminal for remote control and automatic photography. The terminal is provided with a cap, which protects the contacts when the terminal is not in use. The following



accessories can be used (all lengths are approximate):

- **Remote Cord MC-22:** Remote shutter release with blue, yellow, and black terminals for connection to a remote shutter-triggering device, allowing control via sound or electronic signals (length 1 m /3 ft. 3 in.).
- **Remote Cord MC-30:** Remote shutter release; can be used to reduce camera shake or keep the shutter open during a time exposure (length 80 cm /2 ft. 7 in.).
- **Remote Cord MC-36:** Remote shutter release; can be used for interval timer photography or to reduce camera shake or keep the shutter open during a time exposure. Equipped with back-lit control panel, shutter-release lock for use in bulb photography, and timer that beeps at one-second intervals (length 85 cm /2 ft. 9 in.).
- **Extension Cord MC-21:** Can be connected to ML-3 or MC-series 20, 22, 23, 25, 30, or 36. Only one MC-21 can be used at a time (length 3 m /9 ft. 10 in.).
- **Connecting Cord MC-23:** Connects two cameras for simultaneous operation (length 40 cm /1 ft. 4 in.).



**Remote
terminal
accessories**

- **Adapter Cord MC-25:** Ten-pin to two-pin adapter cord for connection to devices with two-pin terminals, including the MW-2 radio control set, MT-2 intervalometer, and ML-2 modulite control set (length 20 cm /8 in.).
- **GPS Adapter Cord MC-35** (pg. 221): Connects GPS devices to D3X via PC cable supplied by manufacturer of GPS device, allowing latitude, longitude, altitude, Coordinated Universal Time (UTC, pg. 224), and heading to be recorded with photographs (length 35 cm /14 in.).
- **GPS Unit GP-1** (pg. 221): Record latitude, longitude, altitude, and UTC time with pictures.
- **Modulite Remote Control Set ML-3:** Allows infrared remote control at ranges of up to 8 m (26 ft.).



■ Approved Memory Cards

The following cards have been tested and approved for use in the D3X:

SanDisk

Extreme IV	SDCFX4	8 GB
		4 GB
		2 GB
Extreme III	SDCFX3	8 GB
		4 GB
		2 GB
		1 GB
Ultra II	SDCFH	8 GB
		4 GB
		2 GB
		1 GB
Standard	SDCFB	4 GB
		2 GB
		1 GB

Lexar Media

Professional UDMA	300 ×	8 GB
		4 GB
		2 GB
Platinum II	80 ×	2 GB
		1 GB
	60 ×	512 MB
		4 GB
Professional	133 × WA	8 GB
		4 GB
		2 GB
		1 GB
	80 × Lt	2 GB
		512 MB

Microdrive

DSCM-11000	1 GB
3K4-2	2 GB
3K4-4	4 GB
3K6	6 GB

Other cards have not been tested. For more details on the above cards, please contact the manufacturer.



Caring for the Camera

Storage

When the camera will not be used for an extended period, remove the battery, and store the battery in a cool, dry area with the terminal cover in place. To prevent mold or mildew, store the camera in a dry, well-ventilated area. Do not store your camera with naphtha or camphor moth balls or in locations that:

- are poorly ventilated or subject to humidities of over 60%
- are next to equipment that produces strong electromagnetic fields, such as televisions or radios
- are exposed to temperatures above 50 °C (122 °F) or below -10 °C (14 °F)

Cleaning

Camera body	Use a blower to remove dust and lint, then wipe gently with a soft, dry cloth. After using the camera at the beach or seaside, wipe off sand or salt with a cloth lightly dampened in distilled water and dry thoroughly. Important: <i>Dust or other foreign matter inside the camera may cause damage not covered under warranty.</i>
Lens, mirror, and viewfinder	These glass elements are easily damaged. Remove dust and lint with a blower. If using an aerosol blower, keep the can vertical to prevent the discharge of liquid. To remove fingerprints and other stains, apply a small amount of lens cleaner to a soft cloth and clean with care.
Monitor	Remove dust and lint with a blower. When removing fingerprints and other stains, wipe the surface lightly with a soft cloth or chamois leather. Do not apply pressure, as this could result in damage or malfunction.

Do not use alcohol, thinner, or other volatile chemicals.

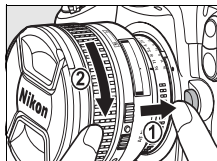


Replacing the Focusing Screen

A type B clear-matte VI focusing screen is inserted in the camera at shipment. To insert an optional type E clear-matte VI focusing screen for D3X cameras (pg. 388):

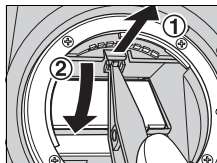
1 Remove the lens.

Turn the camera off and remove the lens.



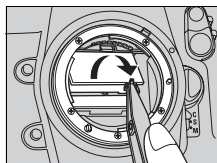
2 Unlatch the screen holder.

Using the tweezers supplied with the focusing screen, pull the focusing screen latch towards you. The screen holder will spring open.



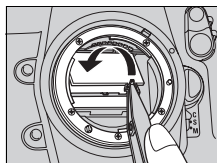
3 Remove the existing screen.

Remove the existing screen, using the supplied tweezers and being careful to handle the screen by the tab to avoid scratches.



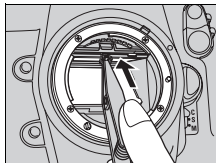
4 Insert the replacement screen.

Using the tweezers and handling the screen by the tab, set the replacement screen in the holder.



5 Latch the screen holder.

Push the front edge of holder upward until it clicks into place.



✓ Replacing Focusing Screens

Do not touch the surface of the mirror or focusing screens.

✎ Framing Grids

The display in type E focusing screens may be slightly out of position depending on how the focusing screen is placed.



Replacing the Clock Battery

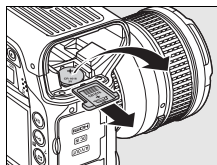
The camera clock is powered by a CR1616 lithium battery with a life of about four years. If the **CLOCK** icon is displayed in the top control panel while the exposure meters are on, the battery is running low and needs to be replaced. When the battery is exhausted, the **CLOCK** icon will blink while the exposure meters are on. Photographs can still be taken but will not be stamped with the correct time and date, and interval timer photography will not function correctly. Replace the battery as described below.

1 Remove the main battery.

The clock battery chamber is located on the roof of the main battery chamber. Turn the camera off and remove the EN-EL4a battery.

2 Open the clock battery chamber.

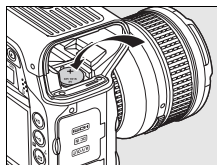
Slide the clock battery chamber cover toward the front of the main battery chamber.



3 Remove the clock battery.

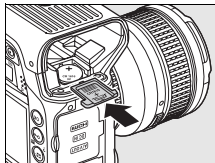
4 Insert the replacement battery.

Insert a new CR1616 lithium battery so that the positive side (the side marked with "+" and the battery name) is visible.



5 Close the clock battery chamber.

Slide the clock battery chamber cover towards the back of the main battery chamber until it clicks into place.

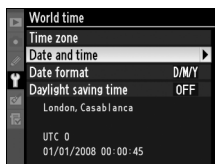


6 Replace the main battery.

Reinsert the EN-EL4a.

7 Set the camera clock.

Set the camera to the current date and time (pg. 40). Until the date and time have been set, the **CLOCK** icon will flash in the top control panel.



CAUTION

Use only CR1616 lithium batteries. Using another type of battery could cause an explosion. Dispose of used batteries as directed.

Inserting the Clock Battery


Insert the clock battery in the correct orientation. Inserting the battery incorrectly could not only prevent the clock from functioning but could damage the camera.





The Low-Pass Filter

The image sensor that acts as the camera's picture element is fitted with a low-pass filter to prevent moiré. If you suspect that dirt or dust on the filter is appearing in photographs, you can clean the filter as described below. Note, however, that the filter is extremely delicate and easily damaged. Nikon recommends that the filter be cleaned only by Nikon-authorized service personnel.

1 Charge the battery or connect an AC adapter.

A reliable power source is required when inspecting or cleaning the low-pass filter. If the battery level is below  (60%), turn the camera off and insert a fully-charged EN-EL4a battery or connect an optional EH-6 AC adapter.

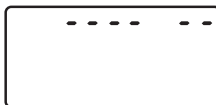
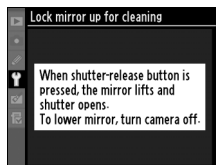
2 Select [Lock mirror up for cleaning].

Remove the lens and turn the camera on. Highlight [Lock mirror up for cleaning] in the setup menu (pg. 346) and press  (note that this option is not available at battery levels of  or below).



3 Press .

The message shown at right will be displayed in the monitor and a row of dashes will appear in the top control panel and viewfinder. To restore normal operation without inspecting the low-pass filter, turn the camera off.

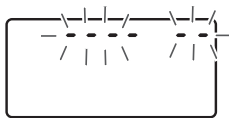


4 Raise the mirror.

Press the shutter-release button all the way down.

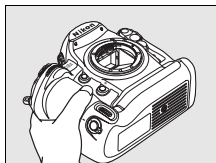
The mirror will be raised and

the shutter curtain will open, revealing the low-pass filter. The display in the viewfinder will turn off and the row of dashes in the top control panel will blink.



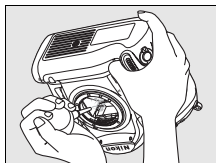
5 Examine the low-pass filter.

Holding the camera so that light falls on the low-pass filter, examine the filter for dust or lint. If no foreign objects are present, proceed to Step 7.



6 Clean the filter.

Remove any dust and lint from the filter with a blower. Do not use a blower-brush, as the bristles could damage the filter. Dirt that can not be removed with a blower can only be removed by Nikon-authorized service personnel. Under no circumstances should you touch or wipe the filter.



7 Turn the camera off.

The mirror will return to the down position and the shutter curtain will close. Replace the lens or body cap.



Use a Reliable Power Source

The shutter curtain is delicate and easily damaged. If the camera powers off while the mirror is raised, the curtain will close automatically. To prevent damage to the curtain, observe the following precautions:

- Do not turn the camera off or remove or disconnect the power source while the mirror is raised.
- If the battery runs low while the mirror is raised, a beep will sound and the self-timer lamp will blink to warn that the shutter curtain will close and the mirror will be lowered after about two minutes. End cleaning or inspection immediately.

Foreign Matter on the Low-Pass Filter

Nikon takes every possible precaution to prevent foreign matter from coming into contact with the low-pass filter during production and shipping. The D3X, however, is designed to be used with interchangeable lenses, and foreign matter may enter the camera when lenses are removed or exchanged. Once inside the camera, this foreign matter may adhere to the low-pass filter, where it may appear in photographs taken under certain conditions. To protect the camera when no lens is in place, be sure to replace the body cap provided with the camera, being careful to first remove all dust and other foreign matter that may be adhering to the body cap.

Should foreign matter find its way onto the low-pass filter, clean the filter as described above, or have the filter cleaned by authorized Nikon service personnel. Photographs affected by the presence of foreign matter on the filter can be retouched using Capture NX 2 (available separately; pg. 391) or the clean image options available in some third-party imaging applications.

Servicing the Camera and Accessories

The camera is a precision device and requires regular servicing. Nikon recommends that the camera be inspected by the original retailer or Nikon service representative once every one to two years, and that it be serviced once every three to five years (note that fees apply to these services). Frequent inspection and servicing are particularly recommended if the camera is used professionally. Any accessories regularly used with the camera, such as lenses or optional Speedlights, should be included when the camera is inspected or serviced.



Caring for the Camera and Battery: Cautions

Do not drop: The product may malfunction if subjected to strong shocks or vibration.

Keep dry: This product is not waterproof, and may malfunction if immersed in water or exposed to high levels of humidity. Rusting of the internal mechanism can cause irreparable damage.

Avoid sudden changes in temperature: Sudden changes in temperature, such as occur when entering or leaving a heated building on a cold day, can cause condensation inside the device. To prevent condensation, place the device in a carrying case or plastic bag before exposing it to sudden changes in temperature.

Keep away from strong magnetic fields: Do not use or store this device in the vicinity of equipment that generates strong electromagnetic radiation or magnetic fields. Strong static charges or the magnetic fields produced by equipment such as radio transmitters could interfere with the monitor, damage data stored on the memory card, or affect the product's internal circuitry.

Do not leave the lens pointed at the sun: Do not leave the lens pointed at the sun or other strong light source for an extended period. Intense light may cause the image sensor to deteriorate or produce a white blur effect in photographs.



Cleaning: When cleaning the camera body, use a blower to gently remove dust and lint, then wipe gently with a soft, dry cloth. After using the camera at the beach or seaside, wipe off any sand or salt using a cloth lightly dampened in pure water and then dry the camera thoroughly. In rare instances, static electricity may cause the LCD displays to light up or go dark. This does not indicate a malfunction, and the display will soon return to normal.

The lens and mirror are easily damaged. Dust and lint should be gently removed with a blower. When using an aerosol blower, keep the can vertical to prevent discharge of liquid. To remove fingerprints and other stains from the lens, apply a small amount of lens cleaner to a soft cloth and wipe the lens carefully.

See “The Low-Pass Filter” (pg. 400) for information on cleaning the low-pass filter.

Lens contacts: Keep the lens contacts clean.

Do not touch the shutter curtain: The shutter curtain is extremely thin and easily damaged. Under no circumstances should you exert pressure on the curtain, poke it with cleaning tools, or subject it to powerful air currents from a blower. These actions could scratch, deform, or tear the curtain.

The shutter curtain may appear to be unevenly colored, but this has no effect on pictures and does not indicate a malfunction.

Storage: To prevent mold or mildew, store the camera in a dry, well-ventilated area. If the product will not be used for an extended period, remove the battery to prevent leakage and store the camera in a plastic bag containing a desiccant. Do not, however, store the camera case in a plastic bag, as this may cause the material to deteriorate. Note that desiccant gradually loses its capacity to absorb moisture and should be replaced at regular intervals.

To prevent mold or mildew, take the camera out of storage at least once a month. Turn the camera on and release the shutter a few times before putting it away.

Store the battery in a cool, dry place. Replace the terminal cover before putting the battery away.



Turn the product off before removing or disconnecting the power source: Do not unplug the product or remove the battery while the product is on or while images are being recorded or deleted. Forcibly cutting power in these circumstances could result in loss of data or in damage to product memory or internal circuitry. To prevent an accidental interruption of power, avoid carrying the product from one location to another while the AC adapter is connected.

Dry the accessory shoe cover: If the camera is used in the rain, water may penetrate the supplied BS-2 accessory shoe cover. Remove and dry the accessory shoe cover after using the camera in the rain.

Notes on the monitor: The monitor may contain a few pixels that are always lit or that do not light. This is common to all TFT LCD monitors and does not indicate a malfunction. Images recorded with the product are unaffected.

Images in the monitor may be difficult to see in a bright light.

Do not apply pressure to the monitor, as this could cause damage or malfunction. Dust or lint on the monitor can be removed with a blower. Stains can be removed by wiping lightly with a soft cloth or chamois leather. Should the monitor break, care should be taken to avoid injury from broken glass and to prevent liquid crystal from the monitor touching the skin or entering the eyes and mouth.



Batteries: Dirt on the battery terminals can prevent the camera from functioning and should be removed with a soft, dry cloth before use.

Batteries may leak or explode if improperly handled. Observe the following precautions when handling batteries:

Turn the product off before replacing the battery.

The battery may become hot when used for extended periods. Observe due caution when handling the battery.

Use only batteries approved for use in this equipment.

Do not expose the battery to flame or excessive heat.

After removing the battery from the camera, be sure to replace the terminal cover.

Charge the battery before use. When taking photographs on important occasions, ready a spare EN-EL4a/EN-EL4 battery and keep it fully charged. Depending on your location, it may be difficult to purchase replacement batteries on short notice.

On cold days, the capacity of batteries tends to decrease. Be sure the battery is fully charged before taking photographs outside in cold weather. Keep a spare battery in a warm place and exchange the two as necessary. Once warmed, a cold battery may recover some of its charge.

Continuing to charge the battery after it is fully charged can impair battery performance.

Used batteries are a valuable resource. Please recycle used batteries in accord with local regulations.



Troubleshooting

If the camera fails to function as expected, check the list of common problems below before consulting your retailer or Nikon representative. Refer to the page numbers in the right-most column for more information.

■ ■ Display

Problem	Solution	Page
Viewfinder is out of focus.	Adjust viewfinder focus or use optional diopter adjustment lenses.	47, 389
Viewfinder is dark.	Insert a fully-charged battery.	48
Displays turn off without warning.	Choose longer delays for Custom Setting c2 ([Auto meter-off delay]) or c4 ([Monitor off delay]).	318, 319
Unusual characters appear in control panels.	See "A Note on Electronically-Controlled Cameras," below.	407
Control panel or viewfinder displays are unresponsive and dim.	The response times and brightness of these displays varies with temperature.	—

🔧 A Note on Electronically-Controlled Cameras

In extremely rare instances, unusual characters may appear in the monitor or control panels and the camera may stop functioning. In most cases, this phenomenon is caused by a strong external static charge. Turn the camera off, remove and replace the battery, and turn the camera on again, or, if you are using an AC adapter (available separately), disconnect and reconnect the adapter and turn the camera on again. In the event of continued malfunction, contact your retailer or Nikon-authorized service representative. Note that disconnecting the power source as described above may result in loss of any data not recorded to the memory card at the time the problem occurred. Data already recorded to the card will not be affected.



■ Shooting

Problem	Solution	Page
Camera takes time to turn on.	Delete files or folders.	—
Shutter-release disabled.	<ul style="list-style-type: none">• Memory card is full or not inserted.• CPU lens with aperture ring attached but aperture not locked at highest f-number. If fE E is displayed in the top control panel, select [Aperture ring] for Custom Setting f7 ([Customize command dials]) > [Aperture setting] to use lens aperture ring to adjust aperture.	42, 49 384
	<ul style="list-style-type: none">• Exposure mode S selected with b u i b selected for shutter speed.	116
Photos are out of focus.	<ul style="list-style-type: none">• Rotate focus-mode selector to S or C.	74
	<ul style="list-style-type: none">• Camera unable to focus using autofocus: use manual focus or focus lock.	80, 83



Problem	Solution	Page
Full range of shutter speeds not available.	Flash in use. Flash sync speed can be selected using Custom Setting e1 ([Flash sync speed]); when using optional SB-900, SB-800, SB-600, or SB-R200 Speedlight, choose [1/250 s (Auto FP)] for full range of shutter speeds.	326
Focus does not lock when shutter-release button is pressed halfway.	Camera is in focus mode C : use AE-L/AF-L button to lock focus.	81
Image size can not be changed.	[Image quality] set to [NEF (RAW)].	70
Can not select focus point	• Unlock focus selector lock.	78
	• Auto-area AF selected for focus mode: choose another mode.	76
	• The camera is in playback mode.	225
	• The camera is in menu operation.	277
	• Press shutter-release button halfway to turn monitor off or activate exposure meters.	50
Camera is slow to record photos.	Turn long exposure noise reduction off.	300
Photos not recorded in live view mode.	<ul style="list-style-type: none"> • Sound of mirror clicking down when shutter-release button was pressed halfway in hand-held mode was mistaken for sound of shutter. • Unless [Release] is chosen for Custom Setting a2 ([AF-S priority selection]), shutter release is disabled if camera is unable to focus when focus mode S is selected in hand-held mode. 	93 93, 306



Problem	Solution	Page
Randomly-spaced bright pixels (“noise”) appear in photos.	<ul style="list-style-type: none"> • Choose lower ISO sensitivity or turn high ISO noise reduction on. • Shutter speed is slower than 8 s: use long exposure noise reduction. 	104, 300 300
Photos are blotched or smeared.	<ul style="list-style-type: none"> • Clean lens. • Clean low-pass filter. 	— 400
Colors are unnatural.	<ul style="list-style-type: none"> • Adjust white balance to match light source. 	140
	<ul style="list-style-type: none"> • Adjust [Set Picture Control] settings. 	162
Can not measure white balance.	Subject is too dark or too bright.	152
Image can not be selected as source for preset white balance.	Image was not created with D3X.	155
White balance bracketing unavailable.	<ul style="list-style-type: none"> • NEF (RAW) or NEF+JPEG image quality option selected for image quality. 	66
	<ul style="list-style-type: none"> • Multiple exposure mode is in effect. 	209



Problem	Solution	Page
Effects of Picture Control differ from image to image.	"A" (auto) is selected for sharpening, contrast, or saturation. For consistent results over a series of photographs, choose a setting other than "A" (auto).	168
Metering can not be changed.	Autoexposure lock is in effect.	127
Exposure compensation can not be used.	Choose exposure mode <i>P</i> , <i>S</i> , or <i>A</i> .	128
Reddish areas appear in photos.	Reddish areas and uneven textures may appear in long time-exposures. Turn long exposure noise reduction on when shooting at shutter speeds of "bulb".	300
Textures are uneven.		



■ Playback

Problem	Solution	Page
Flashing areas appear in images.	Press ▲ or ▼ to choose photo information displayed.	229, 282
Shooting data appear on images.		
A graph appears during playback.		
NEF (RAW) image is not played back.	Photo was taken at image quality of NEF + JPEG.	67
Some photos are not displayed during playback.	Select [All] for [Playback folder].	281
“Tall” (portrait) orientation photos are displayed in “wide” (landscape) orientation.	<ul style="list-style-type: none">• Select [On] for [Rotate tall].• Photo was taken with [Off] selected for [Auto image rotation].• Camera was pointed up or down when photo was taken.	287 351 351
Can not delete photo.	Photo is protected: remove protection.	244
Message is displayed stating that no images are available for playback.	Select [All] for [Playback folder].	281
Can not change print order.	Memory card is full: delete photos.	49
Can not select photo for printing.	Photo is in NEF (RAW) format. Transfer to computer and print using supplied software or Capture NX 2.	262
Can not print photos.	<ul style="list-style-type: none">• Set [USB] to [MTP/PTP].• NEF (RAW) and TIFF photos can not be printed by direct USB connection. Use DPOF print service (TIFF images only) or transfer to computer and print using supplied software or Capture NX 2.	352 262
Photo is not displayed on TV.	Choose correct video mode.	348



Problem	Solution	Page
Photo is not displayed on high-definition video device.	Confirm that HDMI cable (available separately) is connected.	276
Can not copy photos to computer.	Choose correct [USB] option.	257
Photos not displayed in Capture NX 2.	Update software to latest version.	391
Can not use Camera Control Pro 2.	Set [USB] to [MTP/PTP].	257
Computer displays NEF (RAW) images differently from camera.	Third-party software does not display effects of Picture Controls, active D-Lighting, or vignette control. Use ViewNX (supplied) or Capture NX 2 (available separately).	—









■ ■ *Miscellaneous*

Problem	Solution	Page
Date of recording is not correct.	Set camera clock.	40
Menu item can not be selected.	Some options are not available at certain combinations of settings. Note that [Battery info] option is not available when camera is powered by optional EH-6 AC adapter.	355



Error Messages











This section lists the indicators and error messages that appear in the viewfinder, top control panel, and monitor.





Indicator		Problem	Solution	Page
Control panel	Viewfinder			
$fE E$ (blinks)		Lens aperture ring is not set to minimum aperture.	Set ring to minimum aperture (largest f-number).	38
		Low battery.	Ready a fully-charged spare battery.	48
 (blinks)	 (blinks)	Battery exhausted.	Replace battery.	32, 34
 (blinks)	 (blinks)	Battery can not be used.	Contact Nikon-authorized service representative.	—
 (blinks)	—	Camera clock is not set.	Set camera clock.	40
ΔF		No lens attached, or non-CPU lens attached without specifying maximum aperture. Aperture shown in stops from maximum aperture.	Aperture value will be displayed if maximum aperture is specified.	218
—	 (blinks)	Camera unable to focus using autofocus.	Focus manually.	83



Indicator		Problem	Solution	Page
Control panel	View-finder			
M i		Subject too bright; photo will be overexposed.	• Use a lower ISO sensitivity.	104
			• Use optional ND filter.	390
			In exposure mode: S Increase shutter speed	116
			A Choose a smaller aperture (larger f-number)	118



Indicator		Problem	Solution	Page
Control panel	View-finder			
		Subject too dark; photo will be underexposed.	• Use a higher ISO sensitivity.	104
			• Use optional flash. In exposure mode:	187
			 Lower shutter speed	116
			 Choose a larger aperture (smaller f-number)	118
		 selected in exposure mode  .	Change shutter speed or select manual exposure mode.	116, 120
 (blinks)	 (blinks)	Optional flash unit that does not support i-TTL flash control attached and set to TTL.	Change flash mode setting on optional flash unit.	191
—	 (blinks)	If indicator blinks for 3s after flash fires, photo may be underexposed.	Check photo in monitor; if underexposed, adjust settings and try again.	191

Indicator		Problem	Solution	Page
Control panel	View-finder			
 (blinks)	—	Flash unit that does not support red-eye reduction attached and flash sync mode set to red-eye reduction.	Change flash sync mode or use flash unit that supports red-eye reduction.	189
 (blinks)	 (blinks)	Memory insufficient to record further photos at current settings, or camera has run out of file or folder numbers.	<ul style="list-style-type: none"> • Reduce quality or size. • Delete photographs. • Insert new memory card. 	66, 70 281 42
 (blinks)		Camera malfunction.	Release shutter. If error persists or appears frequently, consult Nikon-authorized service representative.	—



Indicator		Problem	Solution	Page
Monitor	Control panel			
No memory card.	(- E -)	Camera cannot detect memory card.	Turn camera off and confirm that card is correctly inserted.	42
This memory card cannot be used. Card may be damaged. Insert another card.	([ERR]) (blinks)	<ul style="list-style-type: none"> • Error accessing memory card. • Unable to create new folder. 	<ul style="list-style-type: none"> • Use Nikon-approved card. • Check that contacts are clean. If card is damaged, contact retailer or Nikon representative. • Delete files or insert new memory card. 	394 — 42, 281
This card is not formatted. Format the card.	F o r (blinks)	Memory card has not been formatted for use in camera.	Format memory card or insert new memory card.	42, 45



Indicator		Problem	Solution	Page
Monitor	Control panel			
Folder contains no images.	—	No images on memory card or in folder(s) selected for playback.	Select folder containing images from [Playback folder] menu or insert different memory card.	42, 281
All images are hidden.	—	All photos in current folder are hidden.	No images can be played back until another folder has been selected or [Hide image] used to allow at least one image to be displayed.	281
File does not contain image data.	—	File has been created or modified using a computer or different make of camera, or file is corrupt.	File can not be played back on camera.	—
Cannot select this file	—	Memory card does not contain images that can be retouched.	Images created with other devices can not be retouched.	364



Indicator		Problem	Solution	Page
Monitor	Control panel			
Check printer.	—	Printer error.	Check printer. To resume, select [Continue] (if available).	263 *
Check paper.	—	Paper in printer is not of selected size.	Insert paper of correct size and select [Continue].	263 *
Paper jam.	—	Paper is jammed in printer.	Clear jam and select [Continue].	263 *
Out of paper.	—	Printer is out of paper.	Insert paper of selected size and select [Continue].	263 *
Check ink supply.	—	Ink error.	Check ink. To resume, select [Continue].	263 *
Out of ink.	—	Printer is out of ink.	Replace ink and select [Continue].	263 *

* See printer manual for more information.



Appendix

The Appendix covers the following topics:

- Defaults pg. 422
- Memory Card Capacity pg. 427
- Exposure Program pg. 430



Defaults

The following defaults are restored either with a two-button reset or using [Reset shooting menu] or [Reset custom settings].

■ ■ Defaults Restored with a Two-Button Reset (pg. 204) ¹

	Option	Default
Shooting menu ²	[ISO sensitivity] (pg. 104)	100
	[Image quality] (pg. 66)	JPEG normal
	[Image size] (pg. 70)	L
	[White balance] (pg. 140)	Auto
	[Fine tuning] (pg. 143)	Off
	[Choose color temp.] (pg. 147)	5000 K
Other settings	Focus point (pg. 78)	Center
	Exposure mode (pg. 112)	Programmed auto
	Flexible program (pg. 115)	Off
	Shutter speed and aperture lock (pg. 123)	Off
	AE lock hold (pg. 125)	Off
	Exposure compensation (pg. 128)	Off
	Bracketing (pg. 130)	Off
	Flash mode (pg. 194)	Front-curtain sync
	FV lock (pg. 198)	Off
Multiple exposure (pg. 206)	Off	

- 1 If the current Picture Control has been modified, existing settings for the Picture Control will also be restored.
- 2 Only the settings in the bank currently selected using the [Shooting menu bank] option will be reset (pg. 291). Settings in all other banks are unaffected.



■ ■ Defaults Restored with [Reset Shooting Menu] (pg. 293)¹

Option	Default
[File naming] (pg. 296)	DSC
[Slot 2] (pg. 72)	Overflow
[Image quality] (pg. 66)	JPEG normal
[Image size] (pg. 70)	Large
[Image area] (pg. 60)	
[Auto DX crop] (pg. 60)	On
[Choose image area] (pg. 61)	FX format (36 × 24)
[JPEG compression] (pg. 68)	Size priority
[NEF (RAW) recording] (pg. 69)	
[Type] (pg. 69)	Lossless compressed
[NEF (RAW) bit depth] (pg. 69)	12-bit
[White balance] (pg. 140)	Auto
Fine tuning (pg. 143)	Off
[Choose color temp.] (pg. 147)	5000K
[Set Picture Control] (pg. 162)	Standard
[Color space] (pg. 183)	sRGB
[Active D-Lighting] (pg. 181)	Off
[Vignette control] (pg. 299)	Normal
[Long exp. NR] (pg. 300)	Off
[High ISO NR] (pg. 300)	Normal
[ISO sensitivity settings] (pg. 104)	
[ISO sensitivity] (pg. 104)	100
[ISO sensitivity auto control] (pg. 106)	Off
[Live view] (pg. 90)	
[Live view mode] (pg. 91)	Hand-held
[Release mode] (pg. 91)	Single frame
[Multiple exposure] (pg. 206)	Reset ²
[Interval timer shooting] (pg. 211)	Reset ³

- 1 With the exception of [Multiple exposure] and [Interval timer shooting], only settings in the current shooting menu bank will be reset.
- 2 Applies to all banks. [Reset shooting menu] can not be selected while shooting is in progress.
- 3 Applies to all banks. Shooting ends when reset is performed.



■ Defaults Restored with [Reset Custom Settings] (pg. 304) *




	Option	Default
a1	[AF-C priority selection] (pg. 305)	Release
a2	[AF-S priority selection] (pg. 306)	Focus
a3	[Dynamic AF area] (pg. 307)	9 points
a4	[Focus tracking with lock-on] (pg. 309)	Normal
a5	[AF activation] (pg. 309)	Shutter/AF-ON
	[Focus point illumination] (pg. 310)	
a6	[Manual focus mode]	On
	[Continuous mode]	On
	[Focus point brightness]	Normal
a7	[Focus point wrap-around] (pg. 311)	No wrap
a8	[AF point selection] (pg. 311)	51 points
a9	[AF-ON button] (pg. 312)	AF-ON
a10	[Vertical AF-ON button] (pg. 313)	AF-ON
b1	[ISO sensitivity step value] (pg. 314)	1/3 step
b2	[EV steps for exposure cntrl.] (pg. 314)	1/3 step
b3	[EV steps for exposure comp.] (pg. 314)	1/3 step
b4	[Easy exposure compensation] (pg. 315)	Off
b5	[Center-weighted area] (pg. 316)	∅ 12 mm
	[Fine tune optimal exposure] (pg. 316)	
b6	[Matrix metering]	0
	[Center-weighted]	0
	[Spot metering]	0
c1	[Shutter-release button AE-L] (pg. 318)	Off
c2	[Auto meter-off delay] (pg. 318)	6 s
c3	[Self-timer delay] (pg. 319)	10 s
c4	[Monitor off delay] (pg. 319)	20 s

* Only the settings in the bank currently selected using the [Custom setting bank] option will be reset (pg. 304). Settings in all other banks are unaffected.



Option		Default
d1	[Beep] (pg. 320)	Off
d2	[Shooting speed] (pg. 321)	
	[Continuous high-speed]	5 fps
	[Continuous low-speed]	3 fps
d3	[Max. continuous release] (pg. 321)	130
d4	[File number sequence] (pg. 322)	On
d5	[Control panel/viewfinder] (pg. 323)	
	[Rear control panel]	ISO sensitivity
	[Viewfinder display]	Frame count
d6	[Shooting info display] (pg. 324)	Auto
d7	[LCD illumination] (pg. 325)	Off
d8	[Exposure delay mode] (pg. 325)	Off
e1	[Flash sync speed] (pg. 326)	1/250 s
e2	[Flash shutter speed] (pg. 327)	1/60 s
e3	[Modeling flash] (pg. 327)	On
e4	[Auto bracketing set] (pg. 328)	AE & flash
e5	[Auto bracketing (Mode M)] (pg. 329)	Flash/speed
e6	[Bracketing order] (pg. 330)	MTR > under > over



	Option	Default
f1	[Multi selector center button] (pg. 331)	
	[Shooting mode]	Select center focus point
	[Playback mode]	Thumbnail on/off
	[Live view]	Select center focus point
f2	[Multi selector] (pg. 332)	Do nothing
f3	[Photo info/playback] (pg. 332)	Info  /Playback 
f4	[Assign FUNC. button] (pg. 333)	
	[FUNC. button press]	None
	[FUNC. button+dials]	Choose image area (FX/DX/5:4)
f5	[Assign preview button] (pg. 339)	
	[Preview button press]	Preview
	[Preview+command dials]	None
f6	[Assign AE-L/AF-L button] (pg. 340)	
	[AE-L/AF-L button press]	AE/AF lock
	[AE-L/AF-L+command dials]	None
f7	[Customize command dials] (pg. 341)	
	[Reverse rotation] (pg. 341)	No
	[Change main/sub] (pg. 341)	Off
	[Aperture setting] (pg. 342)	Sub-command dial
	[Menus and playback] (pg. 342)	Off
f8	[Release button to use dial] (pg. 343)	No
f9	[No memory card?] (pg. 344)	Enable release
f10	[Reverse indicators] (pg. 345)	



Memory Card Capacity

The following table shows the approximate number of pictures that can be stored on a 4 GB SanDisk Extreme IV (SDCFX4) card at different image quality, image size, and image area settings.

■ FX format (36 × 24) Image Area

Image quality	Image size	File size ¹	No. of images ¹	Buffer capacity ²
NEF (RAW), Lossless compressed, 12-bit	—	27.6 MB	100	24
NEF (RAW), Lossless compressed, 14-bit	—	35.6 MB	77	28
NEF (RAW), Compressed, 12-bit	—	23.0 MB	137	26
NEF (RAW), Compressed, 14-bit	—	29.4 MB	114	34
NEF (RAW), Uncompressed, 12-bit	—	38.9 MB	100	22
NEF (RAW), Uncompressed, 14-bit	—	50.6 MB	77	21
TIFF (RGB)	L	73.5 MB	53	22
	M	41.5 MB	94	23
	S	18.6 MB	210	30
JPEG fine ³	L	14.1 MB	277	44
	M	7.9 MB	491	78
	S	3.6 MB	1000	80
JPEG normal ³	L	7.1 MB	552	61
	M	4.0 MB	976	80
	S	1.8 MB	2100	83
JPEG basic ³	L	3.6 MB	1000	69
	M	2.1 MB	1800	82
	S	0.9 MB	4100	83



■ DX Format (24 × 16) Image Area

Image quality	Image size	File size ¹	No. of images ¹	Buffer capacity ²
NEF (RAW), Lossless compressed, 12-bit	—	12.1 MB	229	32
NEF (RAW), Lossless compressed, 14-bit	—	15.5 MB	176	52
NEF (RAW), Compressed, 12-bit	—	10.1 MB	313	38
NEF (RAW), Compressed, 14-bit	—	12.9 MB	260	83
NEF (RAW), Uncompressed, 12-bit	—	17.0 MB	229	29
NEF (RAW), Uncompressed, 14-bit	—	22.1 MB	176	32
TIFF (RGB)	L	31.7 MB	123	24
	M	17.9 MB	218	29
	S	8.1 MB	484	40
JPEG fine ³	L	6.1 MB	644	76
	M	3.4 MB	1100	130
	S	1.6 MB	2400	130
JPEG normal ³	L	3.1 MB	1200	130
	M	1.8 MB	2200	130
	S	0.8 MB	4800	130
JPEG basic ³	L	1.6 MB	2400	130
	M	0.9 MB	4100	130
	S	0.4 MB	8900	130



- 1 All figures are approximate. File size varies with scene recorded.
- 2 Maximum number of exposures that can be stored in memory buffer at ISO 100. Drops if [Optimal quality] is selected for [JPEG compression], ISO sensitivity is set to H 2.3 or higher, [High ISO NR] is on when auto ISO sensitivity control is on or ISO sensitivity is set to 500 or higher, or long exposure noise reduction, active D-Lighting or image authentication is on.
- 3 Figures assume [JPEG compression] is set to [Size priority]. Selecting [Optimal quality] increases the file size of JPEG images; number of images and buffer capacity drop accordingly.

d3—Max. Continuous Release (pg. 321)

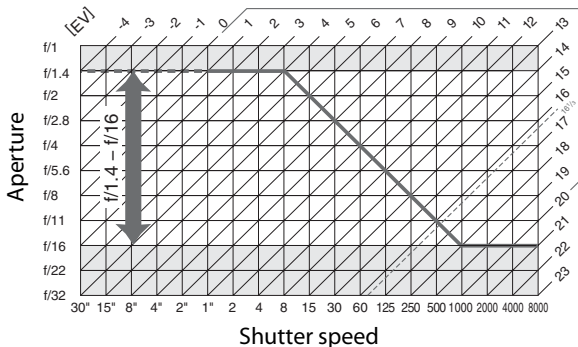
The maximum number of photographs that can be taken in a single burst can be set to any amount between 1 and 130.



Exposure Program

The exposure program for programmed auto is shown in the following graph:

— ISO 100; lens with maximum aperture of f/1.4 and minimum aperture of f/16 (e.g., AF 50mm f/1.4 D)



The maximum and minimum values for EV vary with ISO sensitivity; the above graph assumes an ISO sensitivity of ISO 100 equivalent. When matrix metering is used, values over $16^{1/3}$ EV are reduced to $16^{1/3}$ EV.



Specifications

■ Nikon D3X Digital Camera

Type	
Type	Single-lens reflex digital camera
Lens mount	Nikon F mount (with AF coupling and AF contacts)
Effective pixels	
Effective pixels	24.5 million
Image sensor	
Image sensor	35.9 × 24.0 mm CMOS sensor (Nikon FX format)
Total pixels	25.72 million
Dust-reduction System	Image Dust Off reference data (optional Capture NX 2 software required)
Storage	
Image size (pixels)	<ul style="list-style-type: none">• FX format (36 × 24) image area 6,048 × 4,032 (L) 4,544 × 3,024 (M) 3,024 × 2,016 (S)• DX format (24 × 16) image area 3,968 × 2,640 (L) 2,976 × 1,976 (M) 1,984 × 1,320 (S)• 5 : 4 (30 × 24) image area 5,056 × 4,032 (L) 3,792 × 3,024 (M) 2,528 × 2,016 (S)
File format	<ul style="list-style-type: none">• NEF (RAW): 12 or 14 bit, lossless compressed, compressed, or uncompressed• TIFF (RGB)• JPEG: JPEG-Baseline compliant with fine (approx. 1 : 4), normal (approx. 1 : 8), or basic (approx. 1 : 16) compression ([Size priority]); [Optimal quality] compression available• NEF (RAW)+JPEG: Single photograph recorded in both NEF (RAW) and JPEG formats
Picture Control System	Can be selected from Standard, Neutral, Vivid, Monochrome; storage for up to nine custom Picture Controls
Media	Type I and II CompactFlash memory cards (UDMA compliant); microdrives



Storage	
Double slot	Slot 2 can be used for overflow or backup storage or for separate storage of NEF (RAW) and JPEG images
File system	DCF (Design Rule for Camera File System) 2.0, DPOF (Digital Print Order Format), Exif 2.21 (Exchangeable Image File Format for Digital Still Cameras), PictBridge
Viewfinder	
Viewfinder	Eye-level pentaprism single-lens reflex viewfinder
Frame coverage	<ul style="list-style-type: none"> • FX format: Approx. 100% horizontal and 100% vertical • DX format: Approx. 97% horizontal and 97% vertical • 5 : 4: Approx. 97% horizontal and 100% vertical
Magnification	Approx. $0.7 \times$ (50-mm f/1.4 lens at infinity, -1.0 m^{-1})
Eyepoint	18 mm (-1.0 m^{-1})
Diopter adjustment	$-3 - +1 \text{ m}^{-1}$
Focusing screen	Ships with type B BriteView Clear Matte VI screen
Reflex mirror	Quick return
Depth-of-field preview	When depth of field preview button is pressed, lens aperture is stopped down to value selected by user (M and M modes) or by camera (P and S modes)
Lens aperture	Instant return, electronically controlled
Lens	
Compatible lenses	<ul style="list-style-type: none"> • DX AF Nikkor: All functions supported • Type G or D AF Nikkor: All functions supported (PC Micro-Nikkor does not support some functions). IX Nikkor lenses not supported. • Other AF Nikkor: All functions supported except 3D color matrix metering II. Lenses for F3AF not supported. • AI-P Nikkor: All functions supported except 3D color matrix metering II • Non-CPU: Can be used in exposure modes M and M; electronic rangefinder can be used if maximum aperture is f/5.6 or faster; color matrix metering and aperture value display supported if user provides lens data (AI lenses only)

Shutter	
Type	Electronically-controlled vertical-travel focal-plane shutter
Speed	$1/8000$ – 30 s in steps of $1/3$, $1/2$, or 1 EV, bulb, X250
Flash sync speed	$X=1/250$ s; synchronizes with shutter at $1/250$ s or slower
Release	
Release mode	S (single frame), CL (continuous low speed), CH (continuous high speed), [Live View] (live view), [Self-Timer] (self-timer), MUP (mirror up)
Frame advance rate	<ul style="list-style-type: none"> • DX format (24 × 16): Up to 5 fps (CL) or 5–7 fps (CH) • Other image areas: Up to 5 fps
Self-timer	Can be selected from 2, 5, 10, and 20 s duration
Exposure	
Metering	TTL exposure metering using 1,005-segment RGB sensor
Metering method	<ul style="list-style-type: none"> • Matrix: 3D color matrix metering II (type G and D lenses); color matrix metering II (other CPU lenses); color matrix metering available with non-CPU lenses if user provides lens data • Center-weighted: Weight of 75% given to 12-mm circle in center of frame. Diameter of circle can be changed to 8, 15, or 20 mm, or weighting can be based on average of entire frame (non-CPU lenses use 12-mm circle or average of entire frame) • Spot: Meters 4-mm circle (about 1.5% of frame) centered on selected focus point (on center focus point when non-CPU lens is used)
Range (ISO 100, f/1.4 lens, 20 °C/68 °F)	<ul style="list-style-type: none"> • Matrix or center-weighted metering: 0–20 EV • Spot metering: 2–20 EV
Exposure meter coupling	Combined CPU and AI
Exposure mode	Programmed auto with flexible program (P); shutter-priority auto (S); aperture priority auto (A); manual (M)
Exposure compensation	–5 – +5 EV in increments of $1/3$, $1/2$, or 1 EV
Exposure bracketing	2–9 frames in steps of $1/3$, $1/2$, $2/3$, or 1 EV
Flash bracketing	2–9 frames in steps of $1/3$, $1/2$, $2/3$, or 1 EV



Exposure	
White balance bracketing	2–9 frames in steps of 1, 2, or 3
Exposure lock	Luminosity locked at detected value with AE-L/AF-L button
ISO sensitivity (Recommended Exposure Index)	ISO 100 – 1600 in steps of $\frac{1}{3}$, $\frac{1}{2}$, or 1 EV. Can also be set to approx. 0.3, 0.5, 0.7, or 1 EV (ISO 50 equivalent) below ISO 100 or to approx. 0.3, 0.5, 0.7, 1, or 2 EV (ISO 6400 equivalent) above ISO 1600.
Active D-Lighting	Can be selected from [Auto], [Extra high], [High], [Normal], [Low], or [Off]
Focus	
Autofocus	Nikon Multi-CAM 3500FX autofocus sensor module with TTL phase detection, fine-tuning, 51 focus points (including 15 cross-type sensors)
Detection range	–1 – +19 EV (ISO 100, 20 °C/68 °F)
Lens servo	<ul style="list-style-type: none"> • Autofocus: Single-servo AF (S); continuous-servo AF (C); predictive focus tracking automatically activated according to subject status • Manual (M): Electronic range finding supported
Focus point	Can be selected from 51 or 11 focus points
AF-area mode	Single-point AF, dynamic-area AF, auto-area AF
Focus lock	Focus can be locked by pressing shutter-release button halfway (single-servo AF) or by pressing AE-L/AF-L button
Flash	
Flash control	<ul style="list-style-type: none"> • TTL: i-TTL balanced fill-flash and standard i-TTL flash for digital SLR using combined 1,005-segment RGB sensor are available with SB-900, SB-800, SB-600, or SB-400 • Auto aperture: Available with SB-900 or SB-800 and CPU lens • Non-TTL auto: Supported flash units include SB-900, SB-800, SB-28, SB-27, and SB-22s • Distance-priority manual: Available with SB-900 and SB-800
Flash mode	Front curtain sync, slow sync, rear-curtain sync, red-eye reduction, red-eye reduction with slow sync



Flash	
Flash-ready indicator	Lights when Speedlight such as SB-900, SB-800, SB-600, SB-400, SB-80DX, SB-28DX, or SB-50DX is fully charged; blinks after flash is fired at full output
Accessory shoe	ISO 518 hot shoe with sync and data contacts and safety lock
Nikon Creative Lighting System (CLS)	Advanced Wireless Lighting supported with SB-900, SB-800, or SU-800 as commander and SB-900, SB-800, SB-600, or SB-R200 as remotes; Auto FP High-Speed Sync and modeling illumination supported with all CLS-compatible flash units except SB-400; Flash Color Information Communication and FV lock supported with all CLS-compatible flash units
Sync terminal	ISO 519 sync terminal with locking thread
White balance	
White balance	Auto (TTL white-balance with main image sensor and 1,005 segment RGB sensor); 7 manual modes with fine-tuning; color temperature setting
Live view	
Modes	Hand-held, tripod
Autofocus	<ul style="list-style-type: none"> • Hand-held: Phase-detection AF with 51 focus points (including 15 cross-type sensors) • Tripod: Contrast-detect AF anywhere in frame
Monitor	
Monitor	3-in., 920,000-dot (VGA), low-temperature polysilicon TFT LCD with 170 ° viewing angle, 100% frame coverage, and brightness adjustment
Playback	
Playback	Full-frame and thumbnail (four or nine images) playback with playback zoom, slide show, histogram display, highlight display, auto image rotation, image comment (up to 36 characters), and voice memo input and playback
Interface	
USB	Hi-Speed USB
Video output	Can be selected from NTSC and PAL



Interface	
HDMI output	Type A HDMI connector; camera monitor turns off when HDMI cable is connected
Ten-pin remote terminal	Can be used to connect optional remote control, GP-1 GPS unit, or GPS device compliant with NMEA0183 version 2.01 or 3.01 (requires optional MC-35 GPS adapter cord and cable with D-sub 9-pin connector)
Supported languages	
Supported languages	Chinese (Simplified and Traditional), Dutch, English, Finnish, French, German, Italian, Japanese, Korean, Polish, Portuguese, Russian, Spanish, Swedish
Power source	
Battery	One rechargeable Li-ion EN-EL4a battery
AC adapter	EH-6 AC adapter (available separately)
Tripod socket	
Tripod socket	1/4 in. (ISO 1222)
Dimensions/weight	
Dimensions (W × H × D)	Approx. 159.5 × 157 × 87.5 mm (6.3 × 6.2 × 3.4 in.)
Weight	Approx. 1,220 g (2 lb 11 oz.) without battery, memory card, body cap, or accessory shoe cover
Operating environment	
Temperature	0–40 °C (32–104 °F)
Humidity	Less than 85% (no condensation)

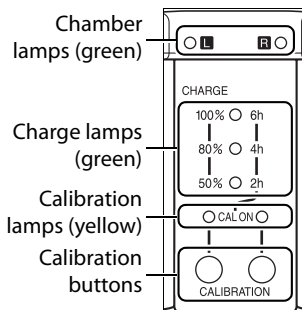
- Unless otherwise stated, all figures are for a camera with a fully-charged battery operating at an ambient temperature of 20 °C (68 °F).
- Nikon reserves the right to change the specifications of the hardware and software described in this manual at any time and without prior notice. Nikon will not be held liable for damages that may result from any mistakes that this manual may contain.



Calibrating Batteries

The MH-22 quick charger is equipped with a battery calibration feature. Calibrate the battery as required to ensure the accuracy of the camera and charger battery level displays.

If the calibration lamp for the current battery chamber blinks when a battery is inserted, the battery needs to be calibrated. To begin calibration, press the calibration button for the current chamber for about a second. The time needed to calibrate the battery is shown by the charge and calibration lamps:



Approximate time needed to recalibrate battery	Calibration lamp	Charge lamps		
		2 h	4 h	6 h
Over 6 hours	○ (glows)	○ (glows)	○ (glows)	○ (glows)
4 – 6 hours	○ (glows)	○ (glows)	○ (glows)	● (off)
2 – 4 hours	○ (glows)	○ (glows)	● (off)	● (off)
Under 2 hours	○ (glows)	● (off)	● (off)	● (off)

When calibration is complete, the calibration and charge lamps will turn off and charging will begin immediately.

Although calibration is recommended for accurate measurement of battery charge state, calibration need not be performed when the calibration lamp blinks. Once begun, calibration can be interrupted as desired.

- If the calibration button is not pressed while the calibration lamp is blinking, normal charging will begin after about ten seconds.
- To interrupt calibration, press the calibration button again. Calibration will end and charging will begin.



Battery Warning

If the chamber and calibration lamps flash on and off in sequence when no battery is inserted, there is a problem with the charger. If the chamber and calibration lamps flash on and off in sequence when a battery is inserted, a problem has occurred with the battery or charger during charging. Remove the battery, unplug the charger, and take the battery and charger to a Nikon-authorized service representative for inspection.

Charging and Calibrating Two Batteries

The MH-22 charges only one battery at a time. If batteries are inserted in both chambers, they will be charged in the order inserted. If the calibration button for the first battery is pressed, the second battery can not be calibrated or charged until calibration and charging of the first battery are complete.



MH-22 quick charger	
Rated input	AC 100–240 V (50/60 Hz)
Rated output	DC 12.6 V/1,200 mA
Supported batteries	Nikon EN-EL4a/EN-EL4 rechargeable Li-ion batteries
Charging time per battery	Approx. 2 hours and 25 minutes (EN-EL4a) or 1 hour and 40 minutes (EN-EL4) when battery is fully discharged
Operating temperature	0–40 °C (+32–104 °F)
Dimensions (W × H × D)	Approx. 160 × 85 × 50.5 mm (6.3 × 3.3 × 2.0 in.)
Length of cord	Approx. 1800 mm (5 ft. 11 in.)
Weight	Approx. 260 g (9.1 oz.), excluding power cable

EN-EL4a rechargeable Li-ion battery	
Type	Rechargeable lithium-ion battery
Rated capacity	11.1 V/2,500 mAh
Dimensions (W × H × D)	Approx. 56.5 × 27 × 82.5 mm (2.2 × 1.1 × 3.2 in.)
Weight	Approx. 180 g (6.3 oz.), excluding terminal cover



Supported Standards

- **DCF Version 2.0:** The Design Rule for Camera File System (DCF) is a standard widely used in the digital camera industry to ensure compatibility among different makes of camera.
- **DPOF:** Digital Print Order Format (DPOF) is an industry-wide standard that allows pictures to be printed from print orders stored on the memory card.
- **Exif version 2.21:** The camera supports Exif (Exchangeable Image File Format for Digital Still Cameras) version 2.21, a standard in which information stored with photographs is used for optimal color reproduction when the images are output on Exif-compliant printers.
- **PictBridge:** A standard developed through cooperation with the digital camera and printer industries, allowing photographs to be output directly to a printer without first transferring them to a computer.
- **HDMI:** High-Definition Multimedia Interface is a standard for multimedia interfaces used in consumer electronics and AV devices capable of transmitting audiovisual data and control signals to HDMI-compliant devices via a single cable connection (the camera uses a type A connector).



Battery Life


The number of shots that can be taken with a fully-charged EN-EL4a battery (2,500 mAh) varies with the condition of the battery, temperature, and how the camera is used. Sample figures are given below.

- **CIPA standard:** Approximately 4,400 shots. Measured at 23 °C/73.4 °F (±2 °C/ 3.6 °F) with an AF-S NIKKOR 24–70mm f/2.8G ED lens under the following test conditions: lens cycled from infinity to minimum range and one photograph taken at default settings once every 30 s. Live view not used.
- **Nikon standard:** Approximately 5,300 shots. Measured at 20 °C/68 °F with an AF-S VR 70–200mm f/2.8 ED lens under the following test conditions: image quality set to JPEG normal, image size set to **L** (large), shutter speed $1/250$ s, shutter-release button pressed halfway for three seconds and focus cycled from infinity to minimum range three times; six shots are then taken in succession and monitor turned on for five seconds and then turned off; cycle repeated once exposure meters have turned off.

The following can reduce battery life:

- Using the monitor
- Keeping the shutter-release button pressed halfway
- Repeated autofocus operations
- Taking NEF (RAW) or TIFF (RGB) photographs
- Slow shutter speeds
- Using the optional WT-4 wireless transmitter
- Using the optional GP-1 GPS unit
- Using VR (vibration reduction) mode with VR lenses

To ensure that you get the most from rechargeable Nikon EN-EL4a batteries:

- Keep the battery contacts clean. Soiled contacts can reduce battery performance.
- Use batteries immediately after charging. Batteries will lose their charge if left unused.
- Check the condition of the battery regularly using the [Battery info] option in the setup menu (pg. 355). If [CAL] is displayed for [Calibration], calibrate the battery using the MH-22 quick charger.



Index

Menu items and options in the camera monitor are shown in brackets ([]).

Symbols

- [] (Single-point AF), 76, 77
- [] (Dynamic-area AF), 76, 77
- [] (Auto-area AF), 76, 77
- S, 86
- CL, 86, 88, 321
- CH, 86, 88, 321
- [], 90
- (Self-timer), 100
- Mup, 102
- [] (Matrix), 110, 317
- [] (Center-weighted), 110, 316, 317
- [] (Spot), 110, 317
- P (Programmed auto), 114
- S (Shutter-priority auto), 116
- A (Aperture-priority auto), 118
- M (Manual), 120
- ? (Help), 31
- [] (Memory buffer), 55, 89, 427
- PRE (Preset manual), 141, 148

Numerics

- 1,005-segment RGB sensor, 140, 193
- 3D color matrix metering II, 110, 111
- 3D-tracking, 308

A

- A/V, 4, 274
 - cable, i, 274
- AC adapter, 387
- Accessories, 387
- [Active D-Lighting], 181
- [Active folder], 293
- AE-L, 81, 125, 340
- AF, 74, 305
- [AF activation], 309
- AF assist, 192
- [AF fine tune], 361
- [AF point selection], 311
- AF-area brackets, 12

- AF-area mode, 76
 - auto-area AF, 76, 77
 - dynamic-area AF, 76, 77, 307
 - single-point AF, 76, 77
- [AF-C priority selection], 305
- [AF-ON button], 312
- AF-ON button, 75, 94, 312
- AF-ON button for vertical shooting, 75, 313
- [AF-S priority selection], 306
- [After delete], 287
- A-M switch, 37
- Amber, 144, 370
- Aperture, 38, 112, 118, 124
 - lock, 124
 - maximum, 84, 218
 - minimum, 112, 430
- Aperture-priority auto, 118
- [Assign AE-L/AF-L button], 340
- [Assign FUNC. button], 333
- [Assign preview button], 339
- Audio, 254, 288, 289, 352
- [Audio output], 254, 352
- Auto bracketing, 130, 328, 329
- [Auto bracketing (Mode M)], 329
- [Auto bracketing set], 328
 - [AE & flash], 131, 328
 - [AE only], 131, 328
 - [Flash only], 131, 328
 - [WB bracketing], 135, 328
- Auto FP high-speed sync, 186, 194, 326
- [Auto image rotation], 351
- Auto meter off, 318
- [Auto meter-off delay], 318
- Auto-area AF, 76, 77
- Autofocus, 74, 76, 78, 80, 82, 305–313

B

- Backlight, 10, 325

Battery, xviii–xix, 32–36, 406
[Battery info], 355
[Beep], 320
Body cap, 4, 37, 391
Bracketing, 130, 328, 329
 exposure, 130, 328
 flash, 130, 328
 white balance, 130, 135, 328
[Bracketing order], 330
Bulb, 122
Burst, 89, 321, 334

C
C, 74, 305
Calibrating, 437
 calibration, 355, 437
 charging, 32
 info, 355
Camera Control Pro 2, 256, 391
Capture NX 2, 66, 353, 391
Center-weighted, 110, 316, 317
[Center-weighted area], 316
Clock, 40, 41
CLS, 186
[Color balance], 370
[Color space], 183
 [Adobe RGB], 183
 [sRGB], 183
Color space, 183, 240
Color temperature, 140, 142, 147
CompactFlash, 42
Computer, 256
Control panel, 8–11
[Control panel/viewfinder], 323
[Copy image(s)], 283
Copying images, 283
Copyright, 237, 357
[Copyright information], 357
CPU contacts, 384
CPU lens, 38, 384
Creative Lighting System, 186
Crop, 267, 368
[Custom setting bank], 304
Custom Settings, 302
Custom Settings Menu, 302

[Customize command dials], 341

D

Date and time, 40, 349
Daylight saving time, 40, 349
DCF version 2.0, 440
Default settings, 204, 422
 restoring, 204
[Delete], 281
 [All], 281
 [Selected], 281
Delete, 58, 245, 281
 all images, 281
 current image, 245
 selected images, 281
Digital Print Order Format, 262, 440
Diopter, 3, 47, 389
 adjustment control, 47
 adjustment lens, 389
[Display mode], 282
[D-Lighting], 366
DPOF, 262
[Dust off ref photo], 353
[Dynamic AF area], 307
 [51 points (3D-tracking)], 308
Dynamic-area AF, 76, 77, 307

E

[Easy exposure compensation], 315
Electronic analog exposure display,
 120, 122, 128
Ethernet, 261, 387
[EV steps for exposure cntrl.], 314
[EV steps for exposure comp.], 314
Exif version 2.21, 440
Exposure, 109, 112, 125, 128, 130
 bracketing, 130
 lock, 125
 meters, 50, 318
 mode, 112
 aperture-priority auto, 118
 manual, 120
 programmed auto, 114
 shutter-priority auto, 116
Exposure bracketing, 130

Exposure compensation, 128

[Exposure delay mode], 325

Exposure preview, 96, 99

F

File information, 230

[File naming], 296

[File number sequence], 322

[Filter effects], 370

[Skylight], 370

[Warm filter], 370

[Fine tune optimal exposure], 316

[Firmware version], 362

Flash, 130, 185, 194, 327, 328

bracketing, 130, 328

control, 193

i-TTL balanced-fill flash for digital SLR, 193

standard i-TTL flash for digital SLR, 193

mode, 194

modeling, 327

monitor pre-flash, 186

range, 197

ready indicator, 191, 199

sync speed, 326

sync terminal, 201

[Flash shutter speed], 327

[Flash sync speed], 326

flexible, 115

Fn button, 64, 198, 333

f-number, 38, 112

Focal length, 218

Focal plane mark, 84

Focus, 74

autofocus, 74, 76, 78, 80, 82

contrast-detect, 90, 95, 97

phase-detection, 90

electronic rangefinder, 84, 382

indicator, 55, 74, 84, 305, 306

lock, 80, 82, 312

mode, 74, 305, 306

continuous-servo AF, 74, 305

manual, 74, 83, 92

single-servo AF, 74, 306

point, 51, 78, 311

contrast-detect, 90, 95, 97

tracking, 75, 77, 309

3D, 76, 77, 308

predictive, 75

[Focus point illumination], 310

[Focus point wrap-around], 311

[Focus tracking with lock-on], 309

Focusing screen, 388, 396

type B clear-matte VI, 388

type E clear-matte VI, 388

Format, 45, 347

[Format memory card], 347

Front-curtain sync, 194

FV lock, 198, 333

G

[GPS], 221

GPS, 221, 229, 238

connecting, 222

data, 229, 238

unit, 221, 393

GPS data, 238

H

[HDMI], 348

HDMI, 276, 348, 440

Help, 31

Hi, 105

[Hide image], 281

High definition, 274, 276, 348, 440

[High ISO NR], 300

Highlights, 231, 232, 282

Histogram, 232, 282

I

[Image area], 60, 63

[5:4 (30x24)], 61

[Auto DX crop], 60, 63

[Choose image area], 61, 63

[DX format (24x16)], 61

- [FX format (36x24)], 61
- Image area, 38, 60, 70, 297
- [Image authentication], 356
- [Image comment], 350
- Image Dust Off, 353
- [Image overlay], 371
- [Image quality], 66
- Image quality, 66
- [Image review], 287
- [Image size], 70
- Image size, 70
- [Index print], 271
- In-focus indicator, 55, 74, 84, 305, 306
- Information, 14, 229, 324
- [Interval timer shooting], 211
- Interval timer shooting, 211
- [ISO sensitivity], 104
 - [ISO sensitivity auto control], 106
 - [Maximum sensitivity], 106
 - [Minimum shutter speed], 106
 - [ISO sensitivity settings], 105
- ISO sensitivity, 103
- [ISO sensitivity step value], 314
- i-TTL, 186, 193

J

- JPEG, 66, 68, 72
- [JPEG compression], 68
 - [Optimal quality], 68
 - [Size priority], 68

L

- L**, 70
- LAN, 387
- [Language], 39, 349
- LCD, 10, 325, 347, 404, 405
- [LCD brightness], 347
- [LCD illumination], 325
- Lens, 37, 84, 382
 - attaching, 37
 - cap, 37, 38
 - cap, rear, 37
 - compatible, 382
 - CPU, 38, 384
 - distance information, 193

- focus ring, 38
- mounting index, 37, 38
- non-CPU, 218, 385
 - data, 219
- removing, 38
- type D, 384
- type G, 384
- [Live view], 90
 - [Live view mode], 91, 94
 - [Hand-held], 91
 - [Tripod], 94
 - [Release mode], 91
- Live view, 90–99
- Lo, 105
- [Lock mirror up for cleaning], 347
- [Long exp. NR], 300

M

- M** (manual focus mode), 74, 83
- M** (medium), 70
- Magenta, 144, 370
- [Manage Picture Control], 170
- Manual, 83, 92, 120
- Mass Storage, 257, 352
- Matrix, 110, 317, 334
 - [Max. continuous release], 321
- Memory buffer, 88, 89
- Memory card, 42, 347, 394
 - capacity of, 427
 - formatting, 45, 347
 - slot, 42, 156, 228
- Metering, 110, 317, 334
 - center-weighted, 110
 - matrix, 110
 - selector, 53, 111
 - spot, 110
- Microdrive, 6, 42, 394
- Mirror, 86, 102
 - lock up for cleaning, 400
- [Modeling flash], 327
- Monitor, 14, 57, 90, 226, 229, 319, 395
- Monitor brightness, 99, 347
- [Monitor off delay], 319
- [Monochrome], 369
 - [Black-and-white], 369

- [Cyanotype], 369
- [Sepia], 369
- Mounting index, 37, 38
- MTP/PTP, 257, 352
- [Multi selector], 332
- [Multi selector center button], 331
- [Multiple exposure], 206
- Multiple exposure, 206
- [My Menu], 376
 - [Add items], 376
 - [Rank items], 379
 - [Remove items], 378
- N**
- NEF, 66, 69
- NEF (RAW), 66, 69
- [NEF (RAW) recording], 69
 - [NEF (RAW) bit depth], 69
 - [12-bit], 69
 - [14-bit], 69
 - [Type], 69
 - [Compressed], 69
 - [Lossless compressed], 69
 - [Uncompressed], 69
- Nikon Transfer, 256, 259
- [No memory card?], 344
- [Non-CPU lens data], 218
- O**
- Overview data, 239, 240
- P**
- PC, 222, 259
- Photo info, 229
- [Photo info/playback], 332
- PictBridge, 263, 440
- Picture angle, 60, 297, 386
- Picture Controls, 162
- Playback, 57, 225, 274
 - folder, 281
 - full-frame, 226
 - information, 229
 - menu, 278
 - slide show, 288
 - thumbnail, 241, 331
 - zoom, 243
- [Playback folder], 281
- [Print (DPOF)], 268
 - [Border], 270
 - [Page size], 270
 - [Start printing], 270
 - [Time stamp], 270
- Print options (PictBridge [Setup] menu), 266
 - [Border], 266
 - [Cropping], 267
 - [No. of copies], 266
 - [Page size], 266
 - [Start printing], 267
 - [Time stamp], 266
- [Print select], 268
 - [Border], 270
 - [Page size], 270
 - [Start printing], 270
 - [Time stamp], 270
- [Print set (DPOF)], 272
- Printing, 262
- Programmed auto, 114
- Protecting photographs, 244
- R**
- Rear-curtain sync, 194
- [Red-eye correction], 367
- Red-eye reduction, 194
- Red-eye reduction with slow sync, 195
- [Release button to use dial], 343
- Release mode, 85
 - continuous, 86, 88
 - high speed, 86, 88
 - low speed, 86, 88
 - live view, 86, 90
 - mirror up, 86, 102
 - self-timer, 86, 100
 - single frame, 86
- Remote cord, 392
- Reset, 204, 293, 304, 422

- [Reset custom settings], 304
- [Reset shooting menu], 293
- [Reverse indicators], 345
- RGB color space, 184
- RGB histogram, 232, 282
- [Rotate tall], 287
- S**
- S** (single-point AF), 76
- S** (single-servo AF), 74, 80
- S** (small), 70
- [Save/load settings], 358
- Saving camera settings, 358
- [Self-timer delay], 319
- Sensitivity, 103
- [Set Picture Control], 164
 - [Monochrome], 164
 - [Filter effects], 167, 169
 - [Toning], 167, 169
 - [Neutral], 164
 - [Standard], 164
 - [Vivid], 164
- Setup menu, 346
- Shooting data, 234, 235, 236, 237
- [Shooting info display], 324
- Shooting menu, 290
- [Shooting menu bank], 291
- [Shooting speed], 321
- Shutter speed, 116, 123
 - auto FP high-speed sync, 186, 194, 326
 - flash sync speed, 194, 326
 - lock, 123
- Shutter-priority auto, 116
- Shutter-release button, 3, 56
- [Shutter-release button AE-L], 318
- [Side-by-side comparison], 374
- Single-point AF, 76
- Size, 70
- [Slide show], 288
 - [Frame interval], 288
- Slide show, 288
- [Slot 2], 72, 296
 - [Backup], 72
 - [Overflow], 72

- [RAW Slot 1-JPEG Slot 2], 72
- Slot selection, 156, 228, 279, 364
- Slow sync, 194
- Speedlight, 186
- Spot, 110, 317

T

- Television, 274
- Ten-pin remote terminal, 4, 221, 392
- Thumbnail, 241, 331
- TIFF (RGB), 66
- Time, 40, 349
- Time exposure, 392
- Timer, 100, 211
- [Trim], 368
- Two-button reset, 204

U

- [USB], 257, 352
 - [Mass Storage], 257, 352
 - [MTP/PTP], 257, 352
- USB, 256, 352
 - cable, i, 256

V

- [Vertical AF-ON button], 313
- Vertical shutter-release button lock, 337
- Video, 274, 348
- [Video mode], 348
- Viewfinder, xviii, 6, 7, 12, 47, 388, 389, 407
 - eyepiece, 47, 100, 213, 388, 389
 - focus, 47
- ViewNX, 163, 350
- [Vignette control], 299
- [Virtual horizon], 360
- Virtual horizon, 99, 335, 360
- [Voice memo], 248, 351
- Voice memo, 227, 246, 247–254
- [Voice memo button], 249, 352
- [Voice memo overwrite], 249, 352
- W**
- WB, 6, 146
 - [White balance], 140
 - [Auto], 140

- [Choose color temp.], 141
- [Cloudy], 141
- [Direct sunlight], 140
- [Flash], 141
- [Fluorescent], 140
- [Incandescent], 140
- [Preset manual], 141
- [Shade], 141
- White balance, 139
 - bracketing, 130, 135
 - preset manual, 141, 148
- Wireless, 187, 261, 262, 356, 387
 - network, 261
 - transmitter, 261, 356
- [Wireless transmitter], 356
- [World time], 40, 349
 - [Date and time], 349
 - [Date format], 349
 - [Daylight saving time], 349
 - [Time zone], 349
- WT-4, 261, 262, 356, 387

Nikon

No reproduction in any form of this manual, in whole or in part (except for brief quotation in critical articles or reviews), may be made without written authorization from NIKON CORPORATION.

NIKON CORPORATION

Fuji Bldg., 2-3 Marunouchi 3-chome,
Chiyoda-ku, Tokyo 100-8331, Japan

© 2008 Nikon Corporation



Printed in Hong Kong
SB8K01(11)
6MB04111-01