

**Nikon**

**En**

The Nikon Guide to Digital Photography  
with the

**D2x**

**DIGITAL CAMERA**



**CE**

# Product Documentation

The documentation for this product includes the manuals listed below. Please be sure to read all instructions thoroughly to get the most from your camera.

## *Quick Start Guide*

The *Quick Start Guide* takes you through the process of unpacking and setting up your Nikon digital camera, taking your first photographs, and transferring them to your computer.

## *Guide to Digital Photography*

The *Guide to Digital Photography* (this manual) provides complete operating instructions for your camera.

## PictureProject reference CD

The PictureProject reference CD contains information on installing and using PictureProject. See the *Quick Start Guide* for viewing instructions.

## **CAUTION: Foreign Matter on the Low-Pass Filter**

Nikon takes every possible precaution to prevent foreign matter from coming into contact with the low-pass filter during production and shipping. The D2X, however, is designed to be used with interchangeable lenses, and foreign matter may enter the camera when lenses are removed or exchanged. Once inside the camera, this foreign matter may adhere to the low-pass filter, where it may appear in photographs taken under certain conditions. To prevent foreign matter from entering the camera, do not exchange lenses in dusty environments. To protect the camera when no lens is in place, be sure to replace the body cap provided with the camera, being careful to first remove all dust and other foreign matter that may be adhering to the body cap.

Should foreign matter find its way onto the low-pass filter, clean the low-pass filter as instructed on pages 252–253 of this manual, or have the low-pass filter cleaned by authorized Nikon service personnel. Photographs affected by the presence of foreign matter on the low-pass filter can be retouched using Nikon Capture 4 version 4.2 or later (available separately) or the clean image options available in some third-party imaging software.

# How to Read This Manual

First, be aware of the warnings, cautions, and notices on pages ii–vii.

Then read “Overview” and “Getting to Know the Camera” to acquaint yourself with the conventions used in this manual and the names of camera parts, then set up the camera as described in “First Steps.”

Now you are ready to take photographs and play them back.

Once you have mastered the basics of digital photography, you can read these sections for complete information on when and how to use camera controls.

Refer to these chapters for more on playback...

...on recording and playing voice memos...

...on camera menus and custom settings...

...on connecting to a computer, printer, or TV...

...and on accessories and troubleshooting.

**Overview**



**Getting to Know the Camera**



**First Steps**



**Basic Photography**



**Basic Playback**



**High-Speed Crop**



**Choosing a Shooting Mode**



**Image Quality and Size**



**Sensitivity (ISO Equivalency)** ISO

**White Balance**



**Image Adjustment**



**Focus**



**Exposure**



**Flash Photography**



**Overlay/Multiple Exposure**



**Interval Timer Photography**



**Self-Timer Mode**



**Non-CPU Lenses**



**Using a GPS Unit** GPS

**Two-Button Reset**



**More About Playback**



**Voice Memos**



**Menu Guide**



**Connections**



**Technical Notes**



# For Your Safety

To prevent damage to your Nikon product or injury to yourself or to others, read the following safety precautions in their entirety before using this equipment. Keep these safety instructions where all those who use the product will read them.

The consequences that could result from failure to observe the precautions listed in this section are indicated by the following symbol:



This icon marks warnings, information that should be read before using this Nikon product to prevent possible injury.

## WARNINGS



### **Do not look at the sun through the viewfinder**

Viewing the sun or other strong light source through the viewfinder could cause permanent visual impairment.



### **Turn off immediately in the event of malfunction**

Should you notice smoke or an unusual smell coming from the equipment or from the AC adapter (available separately), unplug the AC adapter and remove the battery immediately, taking care to avoid burns. Continued operation could result in injury. After removing the battery, take the equipment to a Nikon-authorized service center for inspection.



### **Do not use in the presence of flammable gas**

Do not use electronic equipment in the presence of flammable gas, as this could result in explosion or fire.



### **Do not place strap around the neck of an infant or child**

Placing the camera strap around the neck of an infant or child could result in strangulation.



### **Do not disassemble**

Touching the product's internal parts could result in injury. In the event of a malfunction, the product should be repaired only by a qualified technician. Should the product break open as the result of a fall or other accident, remove the battery and/or AC adapter and then take the product to a Nikon-authorized service center for inspection.



### **Observe proper precautions when handling batteries**

Batteries may leak or explode if improperly handled. Observe the following precautions when handling batteries for use in this product:

- Be sure the product is off before replacing batteries. If you are using an AC adapter, be sure it is unplugged.
- Use only batteries approved for use in this equipment.
- Use only CR1616 lithium batteries to replace the clock battery. Using another type of battery could cause an explosion. Dispose of used batteries as directed.
- Do not attempt to insert batteries upside down or backwards.
- Do not short or disassemble batteries.
- Do not expose batteries to flame or to excessive heat.

- Do not immerse in or expose to water.
- Batteries are prone to leakage when fully discharged. To avoid damage to the product, be sure to remove batteries when no charge remains.
- Discontinue use immediately should you notice any changes in the batteries, such as discoloration or deformation.
- Replace the terminal cover when transporting EN-EL4 rechargeable Li-ion batteries. Do not transport or store with metal objects such as necklaces or hairpins.
- When EN-EL4 batteries are not in use, attach the terminal cover and store in a cool place.
- Immediately after use, or when the product is used on battery power for an extended period, the EN-EL4 battery may become hot. Before removing the battery, turn the camera off and allow the battery to cool.

 **Use appropriate cables**

When connecting cables to the input and output jacks, use only the cables provided or sold by Nikon for the purpose, to maintain compliance with product regulations.

 **Keep out of reach of children**

Particular care should be taken to prevent infants from putting the battery or other small parts into their mouths.

 **Removing memory cards**

Memory cards may become hot during use. Observe due caution when removing memory cards from the camera.

 **CD-ROMs**

The CD-ROMs on which the software and manuals are distributed should not be played back on audio CD equipment. Playing CD-ROMs on an audio CD player could cause hearing loss or damage the equipment.

 **Observe caution when using a flash**

Using a flash close to your subject's eyes could cause temporary visual impairment. Particular care should be observed if photographing infants, when the flash should be no less than one meter (39") from the subject.

 **When using the viewfinder**

When operating the diopter adjustment control with your eye to the viewfinder, care should be taken not to put your finger in your eye accidentally.

 **Avoid contact with liquid crystal**

Should the monitor break, care should be taken to avoid injury due to broken glass and to prevent liquid crystal from the monitor touching the skin or entering the eyes or mouth.

# Caring for the Camera and Battery

## Do not drop

The product may malfunction if subjected to strong shocks or vibration.

## Keep dry

This product is not waterproof, and may malfunction if immersed in water or exposed to high levels of humidity. Rusting of the internal mechanism can cause irreparable damage.

## Avoid sudden changes in temperature

Sudden changes in temperature, such as occur when entering or leaving a heated building on a cold day, can cause condensation inside the device. To prevent condensation, place the device in a carrying case or a plastic bag before exposing it to sudden changes in temperature.

## Keep away from strong magnetic fields

Do not use or store this device in the vicinity of equipment that generates strong electromagnetic radiation or magnetic fields. Strong static charges or the magnetic fields produced by equipment such as radio transmitters could interfere with the monitor, damage data stored on the memory card, or affect the product's internal circuitry.

## Do not point the lens at strong light sources for extended periods

Avoid pointing the lens at the sun or other strong light sources for extended periods when using or storing the camera. Intense light may cause deterioration in the image sensor, producing a white blur effect in photographs.

## Do not touch the shutter curtain

The shutter curtain is extremely thin and easily damaged. Under no circumstances should you exert pressure on the curtain, poke it with cleaning tools, or subject it to powerful air currents from a blower. These actions could scratch, deform, or tear the curtain.

## Handle all moving parts with care

Do not apply force to the battery-chamber, card-slot, or connector covers. These parts are especially susceptible to damage.

## Cleaning

- When cleaning the camera body, use a blower to remove dust and lint, then wipe gently with a soft, dry cloth. After using your camera at the beach or seaside, wipe off any sand or salt using a cloth lightly dampened with pure water and then dry your camera thoroughly. In rare instances, static electricity produced by a brush or cloth may cause the LCD displays to light up or darken. This does not indicate a malfunction, and the display will shortly return to normal.
- When cleaning the lens and mirror, remember that these elements are easily damaged. Dust and lint should be gently removed with a blower. When using an aerosol blower, keep the can vertical (tilting the can could result in liquid being sprayed on the mirror). If you do get a fingerprint or other stain on the lens, apply a small amount of lens cleaner to a soft cloth and wipe the lens carefully.
- See "Technical Notes: Caring for Your Camera" for information on cleaning the low-pass filter (📖 252).

## Storage

- To prevent mold or mildew, store the camera in a dry, well-ventilated area. If you will not be using the product for long periods, remove the battery to prevent leakage and store the camera in a plastic bag containing a desiccant. Do not, however, store the camera case in a plastic bag, as this may cause the material to deteriorate. Note that desiccant gradually loses its capacity to absorb moisture and should be replaced at regular intervals.

- Do not store the camera with naphtha or camphor moth balls, close to equipment that produces strong magnetic fields, or in areas subject to extremes of temperature, for example near a space heater or in a closed vehicle on a hot day.
- To prevent mold or mildew, take the camera out of storage at least once a month. Turn the camera on and release the shutter a few times before putting the camera away again.
- Store the battery in a cool, dry place. Replace the terminal cover before putting the battery away.

### Notes on the monitor

- The monitor may contain a few pixels that are always lit or that do not light. This is a characteristic common to all TFT LCD monitors and does not indicate a malfunction. Images recorded with the product will not be affected.
- Images in the monitor may be difficult to see in a bright light.
- Do not apply pressure to the monitor; this could cause damage or malfunction. Dust or lint on the monitor can be removed with a blower. Stains can be removed by rubbing the surface lightly with a soft cloth or chamois leather.
- Should the monitor break, care should be taken to avoid injury due to broken glass and to prevent the liquid crystal from the monitor touching the skin or entering the eyes or mouth.
- Replace the monitor cover when transporting the camera or leaving it unattended.

### Turn the product off before removing or disconnecting the power source

Do not unplug the product or remove the battery while the product is on, or while images are being recorded or deleted. Forcibly cutting power to the product in these

circumstances could result in loss of data or in damage to product memory or internal circuitry. To prevent an accidental interruption of power, avoid carrying the product from one location to another while the AC adapter is connected.

### Batteries

- When you turn the device on, check the battery-level displayed in the control panel to determine whether the battery needs to be replaced. The battery needs to be replaced when the battery-level indicator is flashing.
- Ready a spare battery and keep it fully charged when taking photographs on important occasions. Depending on your location, you may find it difficult to purchase replacement batteries on short notice.
- On cold days, the capacity of batteries tends to decrease. Be sure the battery is fully charged before taking photographs outside in cold weather. Keep a spare battery in a warm place and exchange the two as necessary. Once warmed, a cold battery may recover some of its charge.
- Should the battery terminals become dirty, wipe them off with a clean, dry cloth before use.
- After removing the battery from the camera, be sure to replace the terminal cover.

### Memory cards

- Turn the power off before inserting or removing memory cards. Inserting or removing cards with the power on could render them unusable.
- Insert memory cards as shown in the illustration at right. Inserting cards upside down or backwards could damage the camera or the card.

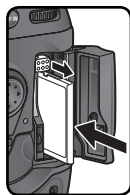

# Notices

- No part of the manuals included with this product may be reproduced, transmitted, transcribed, stored in a retrieval system, or translated into any language in any form, by any means, without Nikon's prior written permission.
- Nikon reserves the right to change the specifications of the hardware and software described in these manuals at any time and without prior notice.
- Nikon will not be held liable for any damages resulting from the use of this product.
- While every effort has been made to ensure that the information in these manuals is accurate and complete, we would appreciate it were you to bring any errors or omissions to the attention of the Nikon representative in your area (address provided separately).

## Notice for customers in the U.S.A.

### Federal Communications Commission (FCC) Radio Frequency Interference Statement

This equipment has been tested and found to comply with the limits for a Class B digital device, pursuant to Part 15 of the FCC rules. These limits are designed to provide reasonable protection against harmful interference in a residential installation. This equipment generates, uses, and can radiate radio frequency energy and, if not installed and used in accordance with the instructions, may cause harmful interference to radio communications. However, there is no guarantee that interference will not occur in a particular installation. If this equipment does cause harmful interference to radio or television reception, which can be determined by turning the equipment off and on, the user is encouraged to try to correct the interference by one or more of the following measures:

- Reorient or relocate the receiving antenna.
- Increase the separation between the equipment and receiver.
- Connect the equipment into an outlet on a circuit different from that to which the receiver is connected.
- Consult the dealer or an experienced radio/television technician for help.

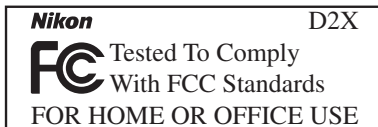

### CAUTIONS

#### *Modifications*

The FCC requires the user to be notified that any changes or modifications made to this device that are not expressly approved by Nikon Corporation may void the user's authority to operate the equipment.

#### *Interface Cables*

Use the interface cables sold or provided by Nikon for your equipment. Using other interface cables may exceed the limits of Class B Part 15 of the FCC rules.

#### **Notice for customers in the State of California**

**WARNING:** Handling the cord on this product will expose you to lead, a chemical known to the State of California to cause birth defects or other reproductive harm. ***Wash hands after handling.***

Nikon Inc.,  
1300 Walt Whitman Road, Melville, New York  
11747-3064, U.S.A. Tel.: 631-547-4200



## **Notice for customers in Canada**

### **CAUTION**

This class B digital apparatus meets all requirements of the Canadian Interference Causing Equipment Regulations.

### **ATTENTION**

Cet appareil numérique de la classe B respecte toutes les exigences du Règlement sur le matériel brouilleur du Canada.

## **Notice Concerning Prohibition of Copying or Reproduction**

Note that simply being in possession of material that has been digitally copied or reproduced by means of a scanner, digital camera or other device may be punishable by law.

### **• Items prohibited by law from being copied or reproduced**

Do not copy or reproduce paper money, coins, securities, government bonds, or local government bonds, even if such copies or reproductions are stamped "Sample."

The copying or reproduction of paper money, coins, or securities which are circulated in a foreign country is prohibited.

Unless the prior permission of the government has been obtained, the copying or reproduction of unused postage stamps or post cards issued by the government is prohibited.

The copying or reproduction of stamps issued by the government and of certified documents stipulated by law is prohibited.

### **• Cautions on certain copies and reproductions**

The government has issued cautions on copies or reproductions of securities issued by private companies (shares, bills, checks, gift certificates, etc.), commuter passes, or coupon tickets, except when a minimum of necessary copies are to be provided for business use by a company. Also, do not copy or reproduce passports issued by the government, licenses issued by public agencies and private groups, ID cards, and tickets, such as passes and meal coupons.

### **• Comply with copyright notices**

The copying or reproduction of copyrighted creative works such as books, music, paintings, woodcut prints, maps, drawings, movies, and photographs is governed by national and international copyright laws. Do not use this product for the purpose of making illegal copies or to infringe copyright laws.

## **Disposing of Data Storage Devices**

Please note that deleting images or formatting memory cards or other data storage devices does not completely erase the original image data. Deleted files can sometimes be recovered from discarded storage devices using commercially available software, potentially resulting in the malicious use of personal image data. Ensuring the privacy of such data is the user's responsibility.

Before discarding a data storage device or transferring ownership to another person, erase all data using commercial deletion software, or format the device and then completely refill it with images containing no private information (for example, pictures of empty sky). Be sure to also replace any pictures selected for preset white balance (📷 59). Care should be taken to avoid injury or damage to property when physically destroying data storage devices.

# Table of Contents

For Your Safety .....	ii
Caring for the Camera and Battery .....	iv
Notices.....	vi
<b>Introduction</b> .....	<b>1</b>
Overview .....	2
Getting to Know the Camera .....	3
First Steps.....	15
Step 1—Attach the Camera Strap .....	15
Step 2—Insert the Battery .....	16
Step 3—Basic Setup .....	17
Step 4—Attach a Lens.....	20
Step 5—Insert a Memory Card .....	22
<b>Tutorial</b> .....	<b>25</b>
Basic Photography.....	26
Step 1—Ready the Camera .....	27
Step 2—Adjust Camera Settings.....	29
Step 3—Frame a Photograph .....	31
Step 4—Focus.....	32
Step 5—Check Exposure .....	33
Step 6—Take the Photograph.....	34
Basic Playback.....	35
<b>Taking Photographs</b> .....	<b>37</b>
Using Camera Menus .....	39
High-Speed Crop .....	41
Choosing a Shooting Mode .....	43
Image Quality and Size .....	45
Image Quality.....	45
Image Size.....	48
Sensitivity (ISO Equivalency) .....	52
White Balance.....	54
Fine-Tuning White Balance .....	56
Choosing a Color Temperature.....	58
Preset White Balance.....	59
Image Adjustment.....	67
Making Edges More Distinct: <i>Image Sharpening</i> .....	67
Adjusting Contrast: <i>Tone Compensation</i> .....	68
Suiting Colors to a Workflow: <i>Color Space</i> .....	69
Matching Colors to the Subject: <i>Color Mode</i> .....	70
Controlling Color: <i>Hue Adjustment</i> .....	71

<b>Focus</b> .....	<b>72</b>
Focus Mode .....	72
Focus Area Selection .....	74
Autofocus .....	76
AF-Area Mode .....	76
Focus Lock .....	80
Getting Good Results with Autofocus .....	82
Manual Focus.....	83
<b>Exposure</b> .....	<b>84</b>
Metering .....	84
Exposure Mode .....	85
Autoexposure Lock.....	95
Exposure Compensation .....	97
Bracketing.....	98
<b>Flash Photography</b> .....	<b>106</b>
TTL Flash Control.....	107
Compatible Speedlights.....	109
Flash Sync Modes .....	112
FV Lock .....	114
Flash Contacts and Indicators .....	116
<b>Overlay/Multiple Exposure</b> .....	<b>117</b>
<b>Interval Timer Photography</b> .....	<b>122</b>
<b>Self-Timer Mode</b> .....	<b>127</b>
<b>Non-CPU Lenses</b> .....	<b>128</b>
<b>Using a GPS Unit</b> .....	<b>132</b>
<b>Two-Button Reset</b> .....	<b>133</b>
<b>More About Playback</b> .....	<b>135</b>
Single-Image Playback .....	136
Photo Information .....	137
Viewing Multiple Images: Thumbnail Playback .....	140
Taking a Closer Look: Playback Zoom .....	142
Protecting Photographs from Deletion .....	143
Deleting Individual Photographs .....	144
<b>Voice Memos</b> .....	<b>145</b>
Recording Voice Memos .....	146
Playing Voice Memos.....	150

<b>Menu Guide</b> .....	<b>153</b>
<b>The Playback Menu</b> .....	<b>154</b>
Delete .....	154
Playback Folder .....	156
Slide Show .....	157
Hide Image.....	159
Print Set .....	161
Display Mode .....	164
Image Review.....	164
After Delete .....	165
Rotate Tall .....	165
<b>The Shooting Menu</b> .....	<b>166</b>
Shooting Menu Bank.....	167
Reset Shooting Menu .....	169
Active Folder .....	170
File Naming .....	171
Image Quality.....	171
Image Size.....	172
Hi-Speed Crop.....	172
JPEG Compression.....	172
Raw Compression .....	172
White Balance.....	172
Long Exp. NR.....	173
High ISO NR .....	173
ISO.....	174
Image Sharpening .....	174
Tone Compensation .....	174
Color Space.....	174
Color Mode.....	174
Hue Adjustment.....	175
Image Overlay .....	175
Multiple Exposure.....	175
Interval Timer Shooting .....	175
Non-CPU Lens Data.....	175
<b>Custom Settings</b> .....	<b>176</b>
<b>The Setup Menu</b> .....	<b>209</b>
Format .....	210
LCD Brightness.....	211
Mirror Lock-up .....	211
Video Mode .....	212
World Time .....	212

Language .....	212
Image Comment .....	213
Auto Image Rotation .....	214
Voice Memo .....	215
Voice Memo Overwrite .....	215
Voice Memo Button .....	215
Audio Output .....	215
USB .....	216
Dust Off Ref Photo .....	217
Battery Info .....	219
Wireless LAN .....	219
Firmware Version .....	227
<b>Connections</b> .....	<b>229</b>
Television Playback .....	230
Connecting to a Computer .....	231
Connecting to a Printer .....	234
<b>Technical Notes</b> .....	<b>239</b>
Optional Accessories .....	240
Lenses for the D2X .....	240
Other Accessories .....	243
Caring for the Camera .....	249
Troubleshooting .....	254
Specifications .....	257
Index .....	262

### **Trademark Information**

Macintosh, Mac OS, and QuickTime are trademarks or registered trademarks of Apple Computer, Inc. Microsoft and Windows are registered trademarks of Microsoft Corporation. Pentium is a trademark of Intel Corporation. CompactFlash is a trademark of SanDisk Corporation. Microdrive is a registered trademark of Hitachi Global Storage Technologies in the United States and/or other countries. Lexar Media is a trademark of Lexar Media Corporation. PictBridge is a trademark. All other trade names mentioned in this manual or the other documentation provided with your Nikon product are trademarks or registered trademarks of their respective holders.

# Introduction

## Getting Started

Overview



2



Getting to Know the Camera



3–14



First Steps



15–24



This chapter is divided into the following sections:

### **Overview**

Read this section for a description of how this manual is organized and for an explanation of the symbols and conventions used.

### **Getting to Know the Camera**

Bookmark this section and refer to it for information on the names and functions of camera parts.

### **First Steps**

This section details the steps required to ready the camera for use: inserting the battery and memory card, attaching a lens and camera strap, and setting the date, time, and language.

Thank you for your purchase of a Nikon D2X single-lens reflex (SLR) digital camera with interchangeable lenses. This manual has been written to help you enjoy taking pictures with your Nikon digital camera. Read this manual thoroughly before use, and keep it handy when using the product.

To make it easier to find the information you need, the following symbols and conventions are used:



This icon marks cautions, information that should be read before use to prevent damage to the camera.



This icon marks tips, additional information that may be helpful when using the camera.



This icon marks notes, information that should be read before using the camera.



This icon indicates that more information is available elsewhere in this manual or in the *Quick Start Guide*.



This icon marks settings that can be adjusted using camera menus.



This icon marks settings that can be fine-tuned from the Custom Settings menu.

## Take Test Shots

Before taking pictures on important occasions (for example, at weddings or before taking the camera with you on a trip), take a test shot to ensure that the camera is functioning normally. Nikon will not be held liable for damages or lost profits that may result from product malfunction.

## Life-Long Learning

As part of Nikon's "Life-Long Learning" commitment to ongoing product support and education, continually-updated information is available on-line at the following sites:

- For users in the U.S.A.: <http://www.nikonusa.com/>
  - For users in Europe and Africa: <http://www.europe-nikon.com/support>
  - For users in Asia, Oceania, and the Middle East: <http://www.nikon-asia.com/>
- Visit these sites to keep up-to-date with the latest product information, tips, answers to frequently-asked questions (FAQs), and general advice on digital imaging and photography. Additional information may be available from the Nikon representative in your area. See the URL below for contact information:

<http://nikonimaging.com/>



# Getting to Know the Camera

## Camera Controls and Displays

Take a few moments to familiarize yourself with camera controls and displays. You may find it helpful to bookmark this section and refer to it as you read through the rest of the manual.

### Camera Body

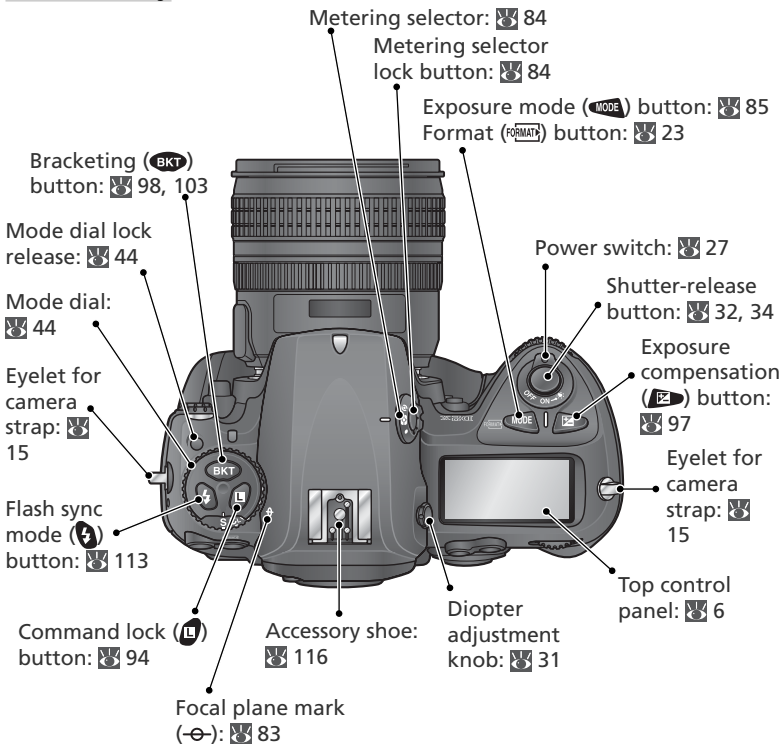

### LCD Illuminators

Holding the power switch in the  position activates the exposure meters and control panel backlights (LCD illuminators), allowing the display to be read in the dark. After the power switch is released, the illuminator will remain lit while the camera exposure meters are active or until the shutter is released.



## Camera Body (continued)

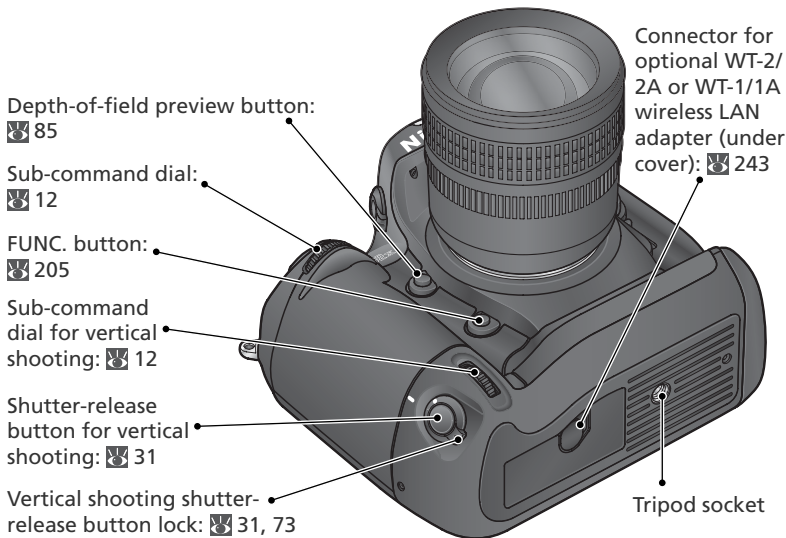
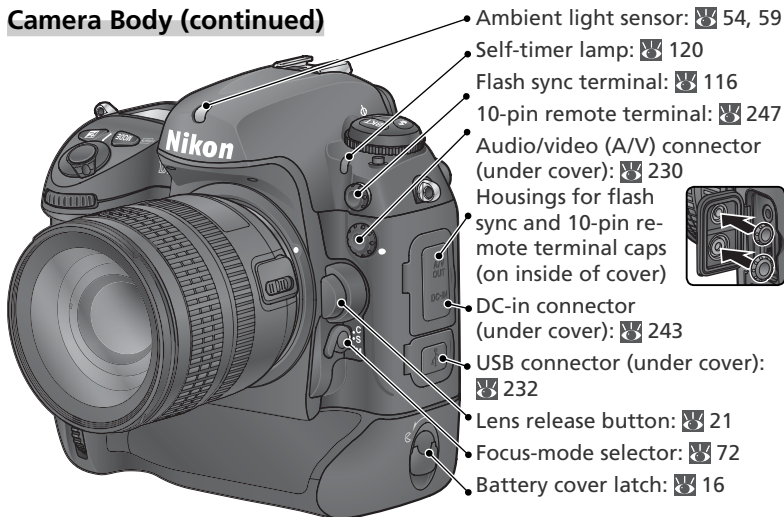

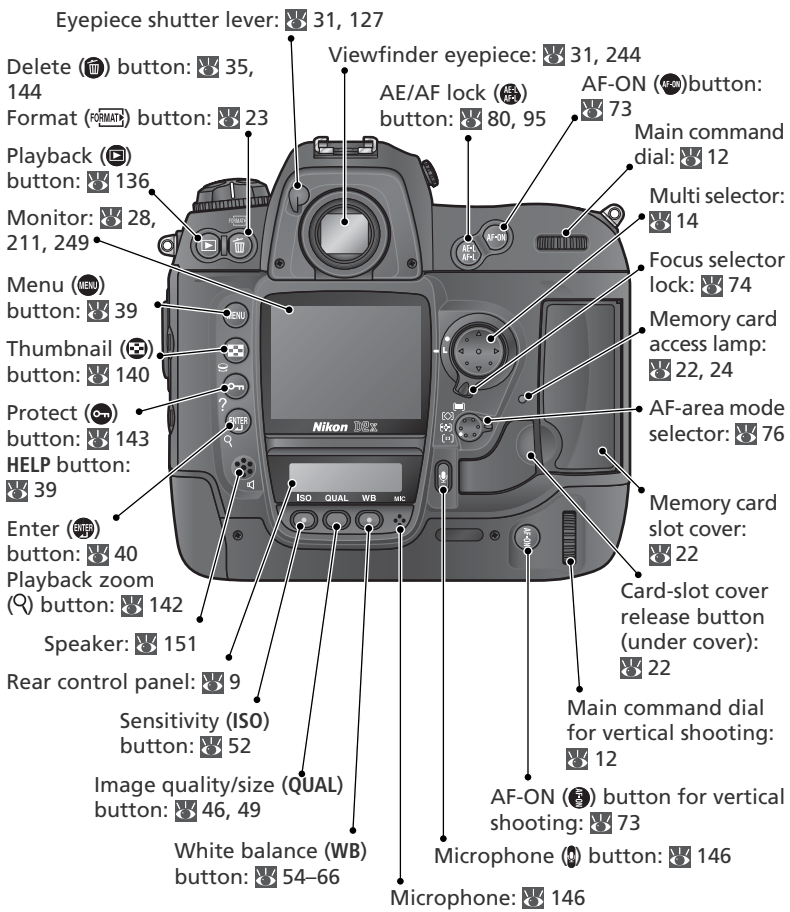

**🔍 The Speaker and Microphone**

Do not bring magnetic devices, such as microdrive cards, close to the built-in speaker or microphone.



## The Top Control Panel

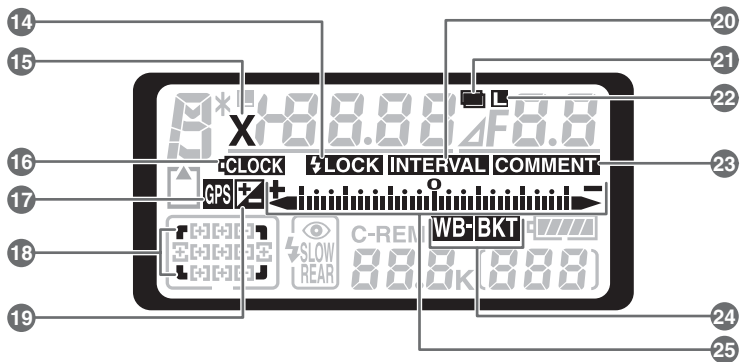
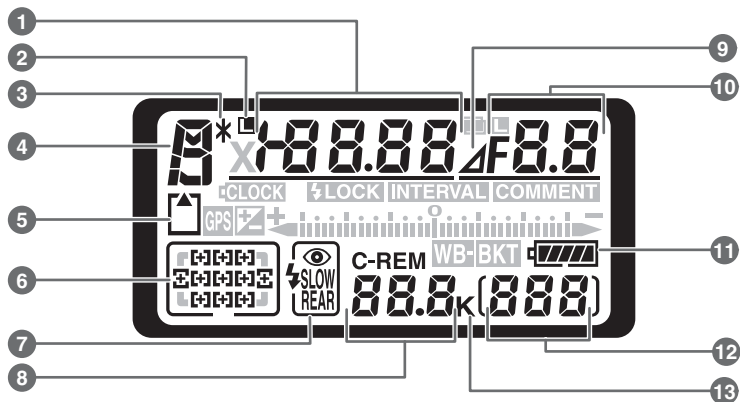



- |    |                                                                    |         |    |                                             |         |
|----|--------------------------------------------------------------------|---------|----|---------------------------------------------|---------|
| 1  | Shutter speed .....                                                | 85–94   | 14 | FV lock indicator .....                     | 114     |
|    | Exposure compensation value .....                                  | 97      | 15 | Sync indicator .....                        | 113     |
|    | Number of shots in bracketing<br>sequence .....                    | 98      | 16 | Clock battery indicator.....                | 19, 251 |
|    | Number of intervals for<br>interval timer photography .....        | 124     | 17 | GPS connection indicator.....               | 132     |
|    | Focal length (non-CPU lens).....                                   | 128     | 18 | High-speed crop indicator.....              | 41      |
|    | Sensitivity (ISO equivalency) .....                                | 52      | 19 | Exposure compensation indicator..           | 97      |
|    | “Busy” indicator .....                                             | 42      | 20 | Interval timer indicator.....               | 124     |
| 2  | Shutter-speed lock icon.....                                       | 94      | 21 | Multiple exposure indicator.....            | 120     |
| 3  | Flexible program indicator.....                                    | 87      | 22 | Aperture lock icon .....                    | 94      |
| 4  | Exposure mode .....                                                | 85      | 23 | Image comment indicator .....               | 213     |
| 5  | Memory card indicator.....                                         | 23, 28  | 24 | Exposure bracketing indicator .....         | 98      |
| 6  | Focus area .....                                                   | 74      |    | White-balance bracketing<br>indicator ..... | 103     |
|    | AF-area mode.....                                                  | 76–79   | 25 | Electronic analog exposure<br>display ..... | 93      |
| 7  | Flash sync mode .....                                              | 112     |    | Exposure compensation .....                 | 97      |
| 8  | Number of exposures<br>remaining .....                             | 28      |    | Bracketing progress<br>indicator .....      | 98–105  |
|    | Number of shots remaining<br>before memory buffer fills.....       | 44      |    | PC mode indicator .....                     | 232     |
|    | Capture mode indicator .....                                       | 232     |    |                                             |         |
| 9  | Aperture stop indicator .....                                      | 91, 93  |    |                                             |         |
| 10 | Aperture (f/-number) .....                                         | 85–94   |    |                                             |         |
|    | Aperture (number of stops).....                                    | 91, 93  |    |                                             |         |
|    | Bracketing increment.....                                          | 99, 103 |    |                                             |         |
|    | Number of shots per interval.....                                  | 124     |    |                                             |         |
|    | Maximum aperture<br>(non-CPU lens).....                            | 131     |    |                                             |         |
|    | PC mode indicator .....                                            | 232     |    |                                             |         |
| 11 | Battery indicator .....                                            | 27      |    |                                             |         |
| 12 | Frame count .....                                                  | 28      |    |                                             |         |
| 13 | “K” (appears when memory remains<br>for over 1000 exposures) ..... | 51      |    |                                             |         |



## The Rear Control Panel

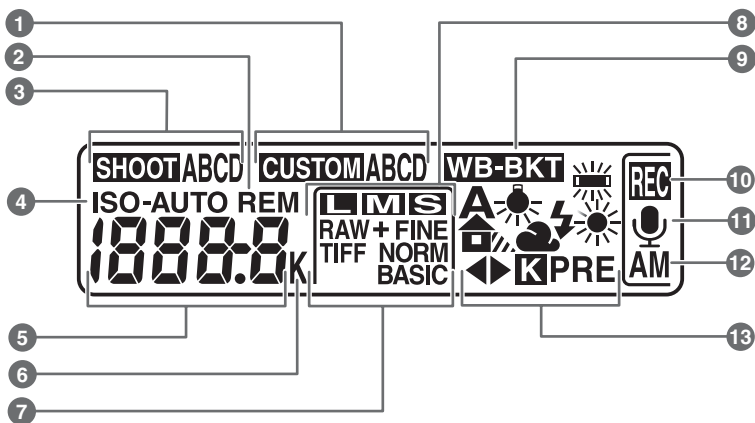

1	Custom settings bank .....	179
2	“Remaining” indicator .....	28
3	Shooting menu settings bank .....	167
4	Sensitivity (ISO) indicator .....	52
	Auto sensitivity indicator .....	188
5	Sensitivity .....	52
	Sensitivity (high gain) .....	52
	Number of exposures remaining .....	28
	Length of voice memo .....	147
	White balance fine-tuning .....	56
	White balance preset number .....	59
	Color temperature .....	58
	PC mode indicator .....	232

6	“K” (appears when memory remains for over 1000 exposures) .....	51
	Color temperature indicator .....	58
7	Image quality .....	45
8	Image size .....	48
9	White-balance bracketing indicator .....	103
10	Voice memo recording indicator (shooting mode) .....	147
11	Voice memo status indicator .....	147
12	Voice memo recording mode .....	148
13	White balance mode .....	54



## The Viewfinder Display

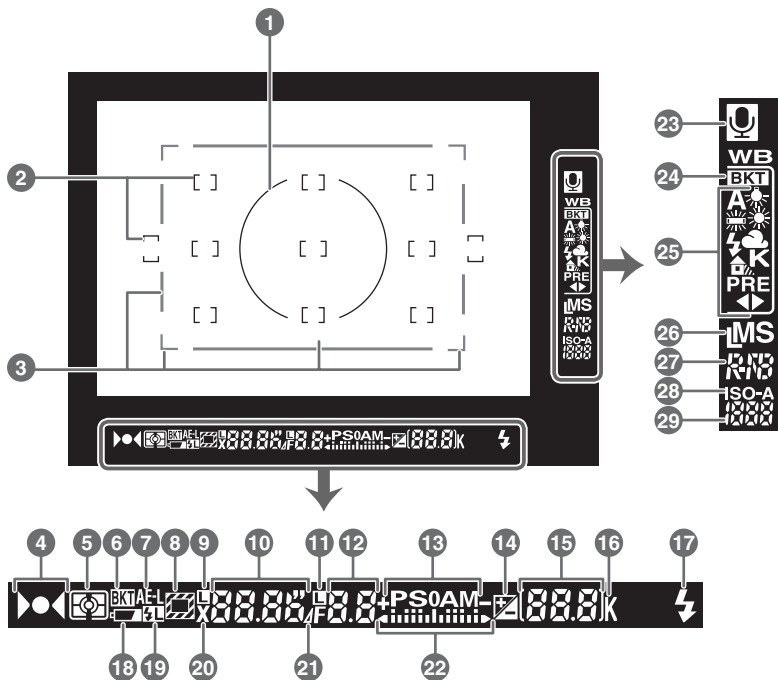

### Focusing Screens

The illustration above shows the dedicated type V clear-matte III focusing screen inserted in the camera at shipment. The supplied type B Brite-View III focusing screen and optional type E clear-matte III grid focusing screen show the four corners of the high-speed crop (see 3, above). See “Replacing the Focusing Screen” (250) for information on exchanging focusing screens.

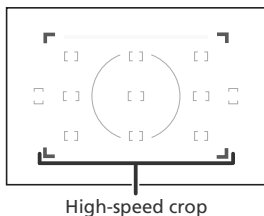





- |    |                                                                 |        |
|----|-----------------------------------------------------------------|--------|
| 1  | 8-mm (0.31") reference circle for center-weighted metering..... | 84     |
| 2  | Focus brackets (focus areas).....                               | 74     |
|    | Spot metering targets.....                                      | 84     |
| 3  | High-speed crop.....                                            | 41     |
| 4  | Focus indicator.....                                            | 32, 83 |
| 5  | Metering.....                                                   | 84     |
| 6  | Bracketing indicator.....                                       | 98     |
| 7  | Autoexposure (AE) lock.....                                     | 95     |
| 8  | High-speed crop indicator.....                                  | 41     |
| 9  | Shutter-speed lock icon.....                                    | 94     |
| 10 | Shutter speed.....                                              | 85–94  |
| 11 | Aperture lock icon.....                                         | 94     |
| 12 | Aperture (f/-number).....                                       | 85–94  |
|    | Aperture (number of stops).....                                 | 91, 93 |
| 13 | Exposure mode.....                                              | 85     |
| 14 | Exposure compensation indicator..                               | 97     |
| 15 | Frame count.....                                                | 28     |
|    | Number of exposures remaining.....                              | 28     |
|    | Number of shots remaining before memory buffer fills.....       | 44     |
|    | Exposure compensation value.....                                | 97     |
|    | PC mode indicator.....                                          | 232    |
| 16 | "K" (appears when memory remains for over 1000 exposures).....  | 51     |
| 17 | Flash-ready indicator.....                                      | 116    |
| 18 | Battery indicator.....                                          | 27     |
| 19 | FV lock indicator.....                                          | 114    |
| 20 | Sync indicator.....                                             | 113    |
| 21 | Aperture stop indicator.....                                    | 91, 93 |
| 22 | Electronic analog exposure display.....                         | 93     |
|    | Exposure compensation.....                                      | 97     |
| 23 | Voice memo status indicator.....                                | 147    |
| 24 | White-balance bracketing indicator.....                         | 103    |
| 25 | White-balance mode.....                                         | 51     |
| 26 | Image size.....                                                 | 48     |
| 27 | Image quality.....                                              | 45     |
| 28 | Sensitivity (ISO) indicator.....                                | 52     |
|    | Auto sensitivity indicator.....                                 | 188    |
| 29 | Sensitivity (ISO equivalency).....                              | 52     |

## The Command Dials

The main- and sub-command dials are used alone or in combination with other controls to adjust a variety of settings. For ease of access when taking photographs in tall (portrait) orientation, dials that duplicate the functions of the main and sub-command dials have been placed close to the shutter-release button for vertical shooting (📷 31).

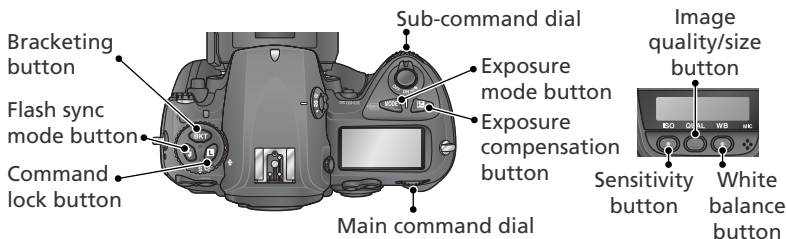

### Image quality and size

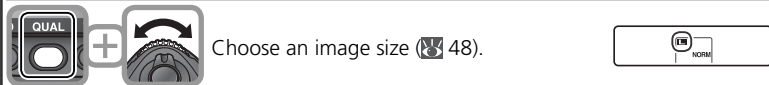
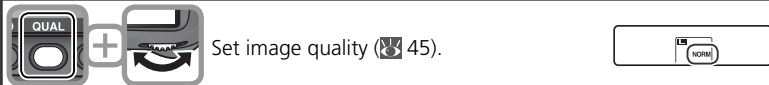



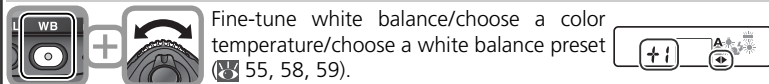
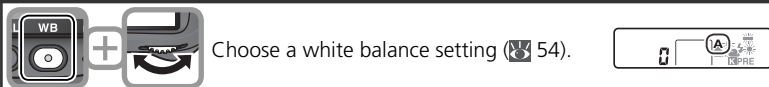



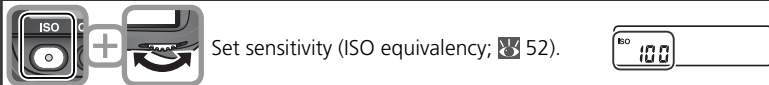



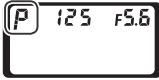

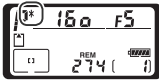

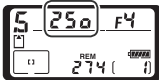

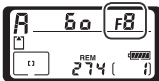
### White balance

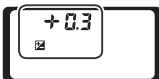

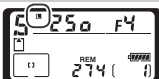

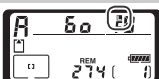
### Sensitivity (ISO equivalency)

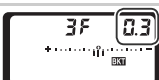

## Exposure

	Choose the exposure mode (▼ 85–93).	
	Choose a combination of aperture and shutter speed (exposure mode P; ▼ 87).	
	Choose a shutter speed (exposure mode S or M; ▼ 88, 92).	
	Choose an aperture (exposure mode A or M; ▼ 90, 92).	
	Set exposure compensation (▼ 97).	
	Shutter speed lock (exposure mode S or M; ▼ 94).	
	Aperture lock (exposure mode A or M; ▼ 94).	
	Activate or cancel bracketing/select number of shots in bracketing sequence (▼ 98, 103).	
	Select bracketing exposure increment (▼ 99, 103).	

## Flash settings

	Choose a flash sync mode for optional Speedlight (▼ 112).	
------------------------------------------------------------------------------------	-----------------------------------------------------------	-------------------------------------------------------------------------------------

## The Multi Selector

The multi selector is used for the following operations:

- **Menu navigation:** Move highlight bar up (⏏ 40).
- **Help:** Scroll up (⏏ 39).
- **Shooting:** Select focus area above current focus area (⏏ 74).
- **Full-frame playback:** Display previous image (⏏ 35).
- **Thumbnail playback:** Highlight thumbnail above current thumbnail (⏏ 140).

- **Menu navigation:** Cancel and return to previous menu (⏏ 40).
- **Shooting:** Select focus area to left of current focus area (⏏ 74).
- **Full-frame playback:** Display previous page of photo information (⏏ 137).
- **Thumbnail playback:** Highlight thumbnail to left of current thumbnail (⏏ 140).

- **Menu navigation:** Move highlight bar down (⏏ 40).
- **Help:** Scroll down (⏏ 39).
- **Shooting:** Select focus area below current focus area (⏏ 74).
- **Full-frame playback:** Display next image (⏏ 35).
- **Thumbnail playback:** Highlight thumbnail below current thumbnail (⏏ 140).

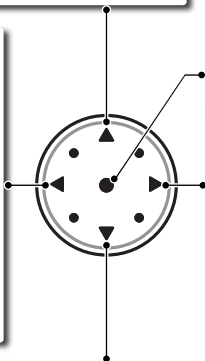











- **Menu navigation:** Select highlighted item (⏏ 40).
- **Shooting:** Select center focus area (⏏ 74).
- **Playback:** Change number of images displayed (⏏ 140).

- **Menu navigation:** Select highlighted item or display sub-menu (⏏ 40).
- **Shooting:** Select focus area to right of current focus area (⏏ 74).
- **Full-frame playback:** Display next page of photo information (⏏ 137).
- **Thumbnail playback:** Highlight thumbnail to right of current thumbnail (⏏ 140).

## The Multi Selector

The  button can also be used to select items highlighted in the camera menus. There may be some cases in which the operations listed on this page do not apply.

Before using the camera for the first time, complete the following steps:

<b>Step 1</b>	<b>Attach the Camera Strap</b> .....		<b>15</b>
<b>Step 2</b>	<b>Insert the Battery</b> .....		<b>16</b>
	<i>For more information on batteries and alternative power sources, see:</i>		
	• Technical Notes: Optional Accessories.....		243
	• Caring for the Camera and Battery .....		iv–v
<b>Step 3</b>	<b>Basic Setup</b> .....		<b>17–19</b>
	<i>For information on changing the clock battery, see:</i>		
	• Technical Notes: Caring for Your Camera .....		251
<b>Step 4</b>	<b>Attach a Lens</b> .....		<b>20–21</b>
	<i>To learn more about the lenses available for the D2X, see:</i>		
	• Technical Notes: Optional Accessories.....		240–242
<b>Step 5</b>	<b>Insert a Memory Card</b> .....		<b>22–24</b>
	<i>To learn more about compatible memory cards, see:</i>		
	• Technical Notes: Approved Memory Cards .....		248
	<i>For more information on formatting memory cards, see:</i>		
	• The Setup Menu: Formatting Memory Cards .....		210

### Step 1—Attach the Camera Strap

Attach the camera strap securely to the two eyelets on the camera body as shown below.

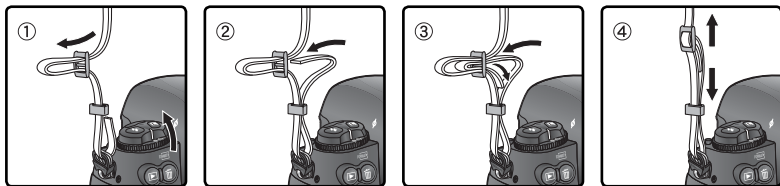

## Step 2—Insert the Battery

The D2X is powered by a rechargeable Nikon EN-EL4 Li-ion battery (provided).

### 2.1 Charge the battery

The EN-EL4 is not fully charged at shipment. To maximize shooting time, charge the battery in the supplied MH-21 quick charger before use (see the MH-21 instruction manual for details). About 100 minutes are required to fully recharge the battery when no charge remains.

### 2.2 Turn the camera off

Turn the camera off before inserting or removing batteries.



### 2.3 Remove the battery-chamber cover

Turn the battery-chamber cover latch to the open position (Ⓢ) and remove the battery-chamber cover.

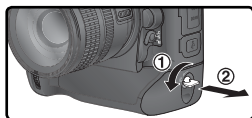

### 2.4 Attach the battery cover to the battery

The battery can be charged with the cover attached. See the instructions provided with the EN-EL4 for details.



### 2.5 Insert the battery

Insert the battery as shown at right.



### 2.6 Latch the battery-chamber cover

To prevent the battery from being dislodged during operation, be sure the cover is securely latched.

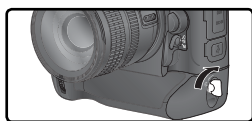

### Removing the Battery

Before removing the battery, turn the camera off and rotate the battery-chamber cover latch to the open position (Ⓢ).

### EN-EL4 Rechargeable Li-ion Batteries

The EN-EL4 shares information with compatible devices, enabling the camera to show battery charge state in six levels and the MH-21 to both display the current level and charge the battery appropriately. The **Battery info** option in the setup menu details battery charge, battery life, and the number of pictures taken (Ⓢ 219).

## Step 3—Basic Setup

Choose a language and set the time and date as described below.

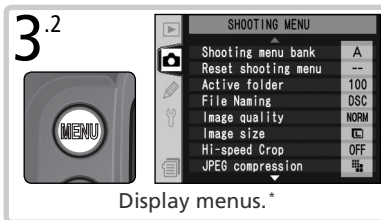
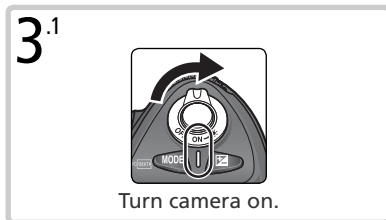

\* If option is highlighted, press multi selector to left until icon at left of menu is selected.

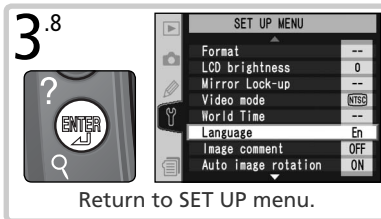
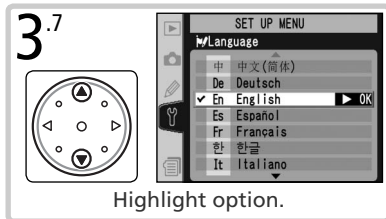
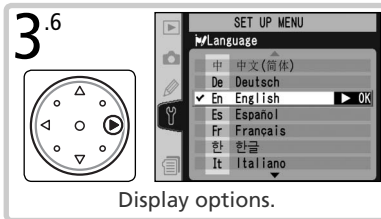
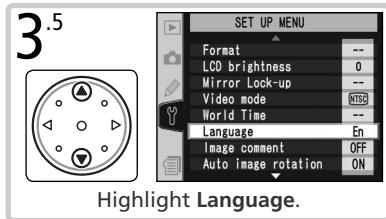
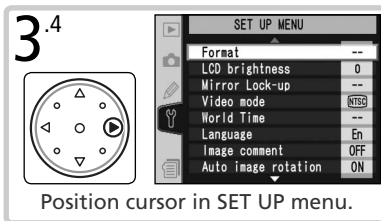
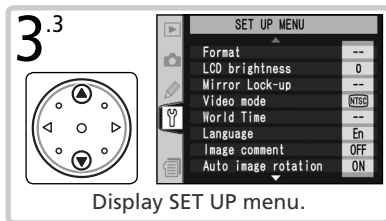

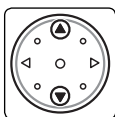

3.9

Highlight **World Time**.

3.10



Display options.

3.11

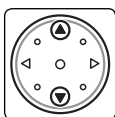
Highlight **Time zone**.

3.12

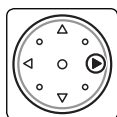

Display map of world time zones.

3.13

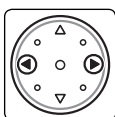
Select local time zone.<sup>†</sup>

3.14

Return to **WORLD TIME** menu.<sup>‡</sup>

<sup>†</sup> **UTC** field shows time difference between selected time zone and Coordinated Universal Time (UTC), in hours.

<sup>‡</sup> If daylight saving time is in effect in local time zone, highlight **Daylight saving time** and press multi selector to right. Press multi selector down to highlight **On** and press multi selector right. Time will automatically be advanced one hour.

3.15

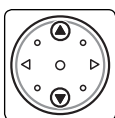
Highlight **Date**.

3.16

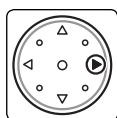
Display **DATE** menu.



3.17

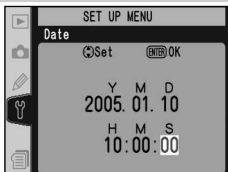
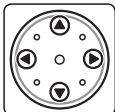

Edit Year, Month, Day, Hour, Minute, and Second. Press multi selector left or right to select item, up or down to change. Press **ENTER** button to set date and time and return to to WORLD TIME menu.

3.18

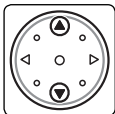

Highlight **Date format**.

3.19

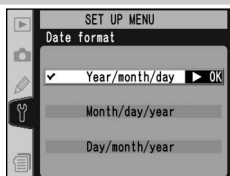
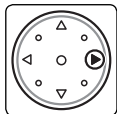

Display options.

3.18

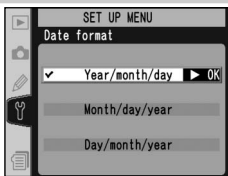
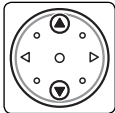

Choose order in which date is listed.

3.19

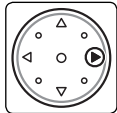

Return to **WORLD TIME** menu.

3.20



Return to **SET UP** menu.

The camera clock is less accurate than most watches and household clocks. Check the clock regularly against more accurate time pieces and reset as necessary. The clock can be reset using the **World Time** option in the setup menu (209).

### The Clock Battery

The clock-calendar is powered by a separate, non-rechargeable CR1616 lithium battery with a life of about four years. When this battery is exhausted, a **⌚** icon will be displayed in the top control panel while the exposure meters are on. For information on replacing the clock battery, see "Technical Notes: Caring for the Camera" (251).



## Step 4—Attach a Lens

Nikon recommends using a type G or type D CPU lens to take full advantage of the features the camera offers.

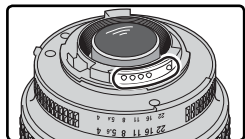

CPU lenses have CPU contacts

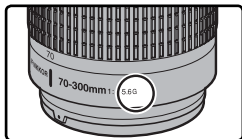

Type G lens



Type D lens

- 4.1 Turn the camera off**  
Turn the camera off before attaching or removing lenses.



- 4.2 Attach a lens**  
Keeping the mounting mark on the lens aligned with the mounting mark on the camera body, position the lens in the camera's bayonet mount. Being careful not to press the lens-release button, rotate the lens counter-clockwise until it clicks into place.

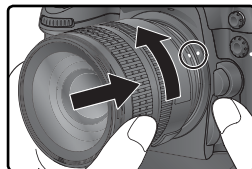

- 4.3 Lock aperture at the minimum setting**  
This step is not necessary if you are using a type G lens not equipped with an aperture ring. If you are using a lens of another type, lock aperture at the minimum setting (highest f/-number).

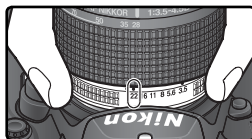

If this step is omitted when attaching a CPU lens, the aperture displays in the control panel and viewfinder will show a blinking **fE E** when the camera is turned on. Photographs can not be taken until the camera is turned off and aperture locked at the highest f/-number.

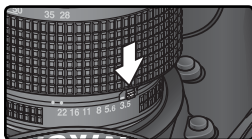



### ✔ **Protect the Camera from Dirt and Dust**

Any dust, dirt, or other foreign matter inside your camera could show up as specks or blotches in your photographs or the viewfinder display. When no lens is in place, keep the lens mount covered with the supplied BF-1A body cap. When exchanging lens or replacing the body cap, keep the lens mount pointed down.

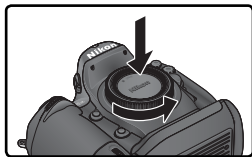

### ✍ **Detaching the Lens**

Be sure the camera is off when removing or exchanging lenses. To remove the lens, press and hold the lens-release button while turning the lens clockwise.

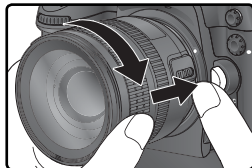



## Step 5—Insert a Memory Card

In place of film, the D2X uses CompactFlash memory cards or microdrive cards to store photographs. For a list of approved memory cards, see “Technical Notes: Approved Memory Cards” (P. 248).

- 5.1 Turn the camera off**  
Turn the camera off before inserting or removing memory cards.



- 5.2 Open the card slot cover**  
Open the door protecting the card-slot cover release button (1) and press the release button (2) to open the card slot (3).

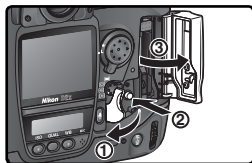

- 5.3 Insert a memory card**  
Insert the memory card with the rear label toward the monitor (1). When the memory card is fully inserted, the green access lamp will light and the eject button will pop up (2). Close the card slot cover.

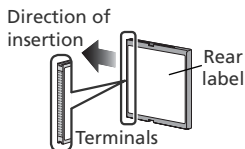

### Inserting Memory Cards

Insert the memory card terminals first. Inserting the card upside down or backwards could damage the camera or the card. Check to be sure that the card is in the correct orientation.

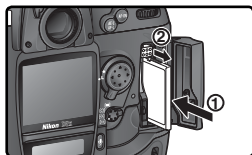

### No Memory Card

If no memory card is inserted in the camera when a charged EN-EL4 battery is inserted or the camera is powered by an AC adapter, [-E-] will appear in the exposure-count displays in the control panel and viewfinder.

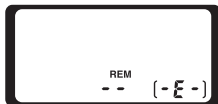

## 5.4 Format the memory card

Memory cards must be formatted before first use.

### ✓ Formatting Memory Cards

*Formatting memory cards permanently deletes any data they may contain.* Be sure to copy any photographs and other data you wish to keep to a computer before proceeding (📄 231–234).

To format the card, turn the camera on and hold the **FORMAT** (🗑️) and **MODE** (🔍) buttons down simultaneously for approximately two seconds. A blinking **For** will appear in the shutter-speed display and the frame count will blink. Pressing both buttons together a second time will format the memory card. Press any other button to exit without formatting.

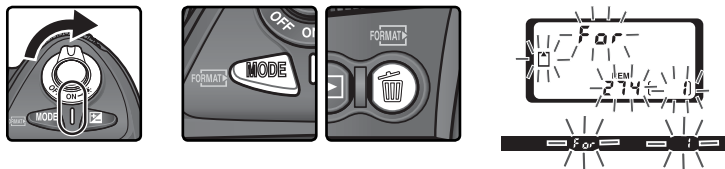

During formatting, the letters **For** will appear in the frame-count display. When formatting is complete, the frame-count display will show the number of photographs that can be recorded at current settings.

### ✓ During Formatting

*Do not remove the card or battery or unplug the AC adapter (available separately) during formatting.*

### 📄 Format (🗑️ 210)

Memory cards can also be formatted using the **Format** option in the setup menu.



### ✓ Memory Cards

- Memory cards may be hot after use. Observe due caution when removing memory cards from the camera.
- Format memory cards before first use.
- Turn the power off before inserting or removing memory cards. Do not remove memory cards from the camera, turn the camera off, or remove or disconnect the power source during formatting or while data are being recorded, deleted, or copied to a computer. Failure to observe these precautions could result in loss of data or in damage to the camera or card.
- Do not touch the card terminals with your fingers or metal objects.
- Do not apply force to the card casing. Failure to observe this precaution could damage the card.
- Do not bend, drop, or subject to strong physical shocks.
- Do not expose to water, high levels of humidity, or direct sunlight.

### ✍ Removing Memory Cards

Memory cards can be removed without loss of data when the camera is off. Before removing the memory card, wait for the green card access lamp next to the card slot cover to go out and then turn the camera off. **Do NOT attempt to remove the card while the access lamp is on.** Failure to observe this precaution could result in loss of data or in damage to the camera or card. Open the door protecting the card-slot cover release button and press the release button to open the card slot, then press the eject button to partially eject the card (①). The card can then be removed by hand (②). Do not push on the memory card while pressing the eject button. Failure to observe this precaution could damage the memory card.

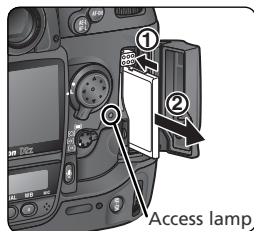

# Tutorial

*Basic Photography and Playback*

Basic Photography



26–34



Basic Playback



35



This chapter takes you step-by-step through the process of taking your first photographs and playing them back.

























## ***Basic Photography***

This section describes how to use autofocus and programmed auto autoexposure for simple, “point-and-shoot” photography that will produce optimal results in most situations.

## ***Basic Playback***

Read this section for information on viewing photographs in the monitor.

There are six basic steps to taking photographs:

- Step 1 Ready the Camera** .....  **27–28**
- To learn how to restore settings to their default values, see:*
- Taking Photographs: Two-Button Reset .....  133
  - Menu Guide: The Shooting Menu—Reset Shooting Menu .....  169
  - Menu Guide: The Custom Settings Menu—Menu Reset .....  180–181
- Step 2 Adjust Camera Settings** .....  **29–30**
- To learn more about the following camera settings, see:*
- Taking Photographs: Choosing a Shooting Mode .....  43–44
  - Taking Photographs: Image Quality and Size .....  45–51
  - Taking Photographs: Sensitivity (ISO Equivalency) .....  52–53
  - Taking Photographs: White Balance .....  54–66
  - Taking Photographs: Image Adjustment .....  67–71
  - Taking Photographs: Focus .....  72–83
  - Taking Photographs: Exposure .....  84–105
- Step 3 Frame the Photograph** .....  **31**
- To learn how to preview the effects of aperture, see:*
- Taking Photographs: Exposure .....  85
- To learn about optional viewfinder accessories, see:*
- Technical Notes: Optional Accessories .....  244
- Step 4 Focus** .....  **32**
- To learn more about focus options, see:*
- Taking Photographs: Focus .....  72–83
- Step 5 Check Exposure** .....  **33**
- To learn how to change the composition after setting exposure, see:*
- Taking Photographs: Exposure .....  95
- To learn more about flash photography, see:*
- Taking Photographs: Flash Photography .....  106–116
- Step 6 Take the Photograph** .....  **34**
- For information on time-lapse photography, see:*
- Taking Photographs: Interval Timer Photography .....  122–126
- To learn how to delay shutter release, see:*
- Taking Photographs: Self-Timer Mode .....  127
- For information on image overlay and multiple exposures, see:*
- Taking Photographs: Overlay/Multiple Exposure .....  117–121



## Step 1—Ready the Camera

Before taking photographs, ready the camera as described below.

- 1.1 Turn the camera on**  
The control panel will turn on and the display in the viewfinder will light.

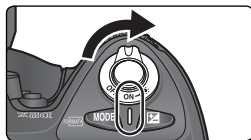

- 1.2 Check the battery level**  
Check the battery level in the viewfinder or top control panel.

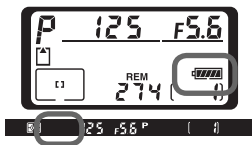

Icon*		Status	Notes
Control panel	Viewfinder		
	—	Battery fully charged	Aperture and shutter-speed indicators in top control panel and all indicators in viewfinder turn off if no operations are performed for 6s (auto meter off). Press shutter-release button halfway to reactivate display.
	—	Battery partially discharged	
	—	Low battery	
		Battery exhausted	
		Battery exhausted	Shutter release disabled.

\* No icon displayed when camera powered by optional AC adapter.



### The Battery Indicator

If the segments in the control panel battery icon blink on and off, the camera is calculating the battery charge. The battery level will be displayed in about three seconds.

### The Icon

A flashing icon in the control panel indicates that the battery has malfunctioned or is otherwise unsuitable for use in the D2X (the icon in the viewfinder may also flash). Contact a Nikon-authorized service representative.

### 1.3 Check the number of exposures remaining

The exposure-count display in the top control panel shows the number of photographs that can be taken at current settings. When this number reaches zero, the  icon will flash in the top control panel and a flashing  icon will appear in the viewfinder. No further pictures can be taken until you delete pictures or insert a new memory card. You may be able to take additional pictures at lower image quality or size settings.

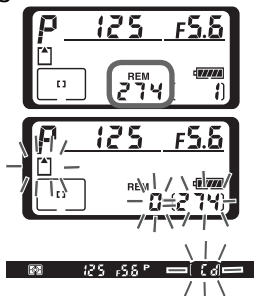

#### The Monitor Cover

A clear plastic cover (the BM-3 LCD monitor cover) is provided with the camera to keep the monitor clean, and to protect the monitor when the camera is not in use or when you are transporting the camera. To remove the monitor cover, hold the camera firmly, take the cover by its edges, and pull the bottom of the cover gently outwards as shown at right (1). Once the cover is unlatched, you can move it slightly away from the monitor and then remove it as shown (2).

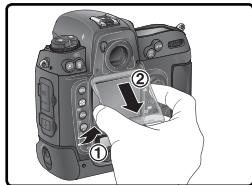

To replace the cover for shooting or storage, insert the two projections on the top of the cover into the matching indentations above the camera monitor (1), then press the bottom of the cover until you hear it click into place (2).

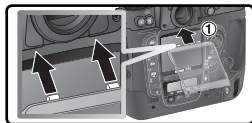

#### Camera Off Display

If the camera is turned off with a battery and memory card inserted, the frame count and number of exposures remaining will be displayed (some memory cards may only display this information when the camera is on).



## Step 2—Adjust Camera Settings

This tutorial describes how to take photographs at the default settings listed in the table below, using a type G or D lens. Information on when and how to change settings from their default values is provided in “Taking Photographs” (37).

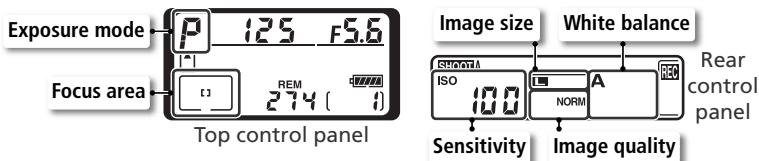

Option	Default	Description	
Image quality	<b>NORM</b> (JPEG Normal)	Pictures are compressed for balance between image quality and file size that is ideal for snapshots.	45–48
Image size	<b>L</b> (Large)	Images are 4,288 × 2,848 pixels in size.	48–49
Sensitivity	<b>100</b>	Sensitivity (digital equivalent of film speed) set to value roughly equivalent to ISO 100.	52–53
White balance	<b>A</b> (Auto)	White balance is adjusted automatically for natural colors under most types of lighting.	54–66
Exposure mode	<b>P</b> (Programmed auto)	Built-in exposure program automatically adjusts shutter speed and aperture for optimal exposure in most situations.	85–93
Focus area	Center focus area	Camera focuses on subject in center focus area.	74

### 2.1 Set the shooting mode to single frame (43)

Hold the mode-dial lock release down (1) and turn the shooting mode dial (2) to **S** (single frame). At this setting, the camera will take one photograph each time the shutter-release button is pressed.

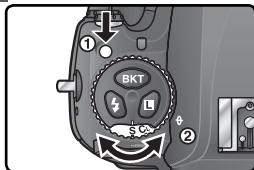

## 2.2 Choose single-area AF (76)

Rotate the AF-area mode selector until it clicks into place pointing to [•] (single-area AF). At this setting, the user can choose from eleven focus areas. Pressing the shutter-release button halfway locks focus at the distance to the subject in the selected focus area.



## 2.3 Choose single-servo autofocus (72)

Rotate the focus-mode selector until it clicks into place pointing to S (single-servo autofocus). At this setting, the camera will automatically focus on the subject in the selected focus area when the shutter-release button is pressed halfway. Pictures can only be taken when the camera is in focus.



## 2.4 Choose matrix metering (84)

Press the metering selector lock button and rotate the metering selector to [•] (matrix metering). Matrix metering uses information from all areas of the frame to determine exposure, ensuring optimal results for the entire frame. If a type G or D lens is mounted on the camera, 3D matrix metering II is used for exposure control that takes into account maximum brightness, contrast, and the distance to the subject.

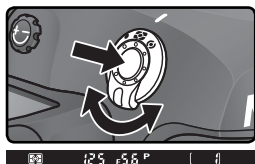

When matrix metering is selected, the metering display in the viewfinder shows [•].

### Step 3—Frame a Photograph

To prevent blurred photographs caused by unsteady hands (camera shake), hold the camera steadily in both hands, with your elbows propped lightly against your torso for support. Hold the handgrip in your right hand and cradle the camera body or lens with your left.



The shutter-release button for vertical shooting (Ⓜ 4) can be used when taking photographs in portrait (tall) orientation.

The recommended stance for taking photographs is with one foot a half pace in front of the other and your upper body stable.

#### 🔍 Viewfinder Focus

The viewfinder is equipped with diopter adjustment to accommodate individual differences in vision. To adjust viewfinder focus, pull the diopter adjustment knob out (①) and rotate it until the viewfinder display and focus brackets are in sharp focus (②). When operating the diopter adjustment knob with your eye to the viewfinder, be careful not to put your fingers or fingernails in your eye.

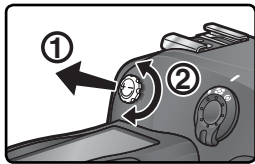

Diopter can be adjusted in the range  $-3\text{ m}^{-1}$  to  $+1\text{ m}^{-1}$ . Corrective lenses (available separately; Ⓜ 244) allow diopters of  $-6\text{ m}^{-1}$  to  $+3\text{ m}^{-1}$ .

#### 🔍 Attaching Diopter Adjustment Viewfinder Lenses

Before attaching a diopter-adjustment viewfinder lens, remove the DK-17 viewfinder eyepiece by closing the viewfinder shutter to release the eyepiece lock (①) and then unscrewing the eyepiece as shown at right (②).



## Step 4—Focus

In single-servo AF, the camera focuses on the subject in the selected focus area when the shutter-release button is pressed halfway. After centering the focus brackets on your subject, press the shutter-release button halfway and check focus in the viewfinder.

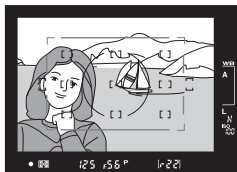
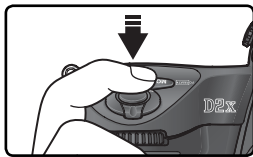

Viewfinder display	Description
●	Subject in focus.
▶	Focus point is between camera and subject.
◀	Focus point is behind subject.
▶ ◀ (flashes)	Camera unable to focus on subject in focus brackets using autofocus.

To focus on an off-center subject, use focus lock (🔒 80–81) or select the focus area containing your subject using the multi selector (🔍 74). For information on what to do if the camera is unable to focus using autofocus, see “Getting Good Results with Autofocus” (🔍 82).

## Step 5—Check Exposure

In exposure mode **P** (programmed auto), the camera automatically sets shutter speed and aperture when the shutter-release button is pressed half-way. Before shooting, check the shutter-speed and aperture indicators in the viewfinder. If the photo would be under- or over-exposed at current settings, one of the following indicators will appear in either the shutter-speed or aperture display.

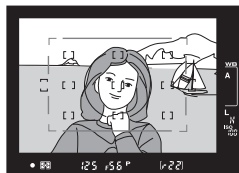

Indicator	Description
	Photo will be overexposed. Use optional Neutral Density (ND) filter.
	Photo will be underexposed. Raise sensitivity ( 52–53) or use optional Speedlight ( 106).

### Shutter Speed and Camera Shake

To prevent blurring caused by camera shake, the shutter speed should be faster than the inverse of the focal length of the lens, in seconds (for example, if a lens has a focal length of 50 mm, shutter speed should be faster than  $\frac{1}{50}$ s). Use of a tripod is recommended when shooting at slower shutter speeds. To prevent blur, try increasing sensitivity ( 52–53) or using a VR lens. An optional Speedlight ( 106) can be used to prevent blur at shutter speeds of  $\frac{1}{60}$ s or slower.

## Step 6—Take the Photograph

Smoothly press the shutter-release button the rest of the way down.

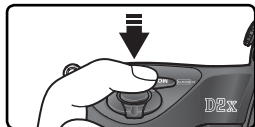

While the photograph is being recorded to the memory card, the access lamp next to the card slot cover will light. **Do not eject the memory card, turn the camera off, or remove or disconnect the power source until the lamp has gone out.** Removing the memory card or cutting power in these circumstances could result in loss of data.

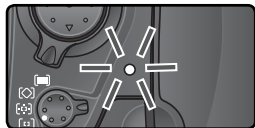

### ✓ Do Not Photograph Strong Light Sources

Avoid taking pictures with the camera focused on the sun or other strong light source. Intense light may cause deterioration in the image sensor the camera uses in place of film. It may also produce a white blur effect in photographs.

### ☰ Rotate Tall (165)

This playback menu option controls whether portrait-orientation photographs taken with **On** selected for the **Auto image rotation** option in the setup menu are automatically rotated during playback.

### ☰ Image Review (164)

Photographs can be viewed at any time during or after recording by pressing the **▶** button. When **On** is selected for the **Image review** option in the playback menu, photographs are automatically displayed in the monitor immediately after shooting.



To play photographs back, press the  button. The most recent photograph will be displayed in the monitor.





### Viewing Additional Photographs

To page through photographs in the order recorded, press the multi selector down. Press the multi selector up to view photographs in reverse order. To scroll rapidly through the images on the memory card, press and hold the up or down buttons on the multi selector.

When the last photograph on the memory card is displayed, you can return to the first photograph by pressing the multi selector down. When the first photograph in memory is displayed, you can view the last photograph by pressing the multi selector up.

### Deleting Unwanted Photographs

To delete the photograph currently displayed in the monitor, press the  button. A confirmation dialog will be displayed. Press the  button again to delete the image and return to playback. To exit without deleting the picture, press the multi selector left or right.

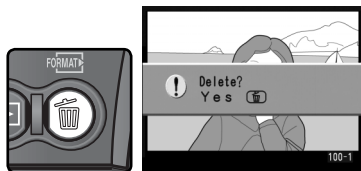

### Take Additional Photographs

To end playback and return to shooting mode, press the  button or press the shutter-release button halfway.

### Delete 154













To delete multiple images, use the **Delete** option in the playback menu.



# Taking Photographs

*The Details*

“Tutorial: Basic Photography” described the basic order of operations for taking photographs at the most commonly-used settings. This chapter explains how and when to adjust camera settings for different shooting conditions.

Using Camera Menus	
 39–40	
High-Speed Crop	
 41–42	
Choosing a Shooting Mode	
 43–44	
Image Quality and Size	
 45–51	
Sensitivity (ISO Equivalency)	
 52–53	
White Balance	
 54–66	
Image Adjustment	
 67–71	
Focus	
 72–83	
Exposure	
 84–105	
Flash Photography	
 106–116	
Overlay/Multiple Exposure	
 117–121	
Interval Timer Photography	
 122–126	
Self-Timer Mode	
 127	
Non-CPU Lenses	
 128–131	
Using a GPS Unit	
 132	
Two-Button Reset	
 133	

The chart below shows the basic order for adjusting settings when taking photographs. Before proceeding, be sure to read "Using Camera Menus" (📷 39) for information on menu operations.

<b>Will this be a single photo, or a series of photos?</b>		
➔	High-Speed Crop .....	📷 41–42
➔	Choosing a Shooting Mode .....	📷 43–44
<b>How will this photograph be used?</b>		
➔	Image Quality and Size .....	📷 45–51
➔	Image Adjustment .....	📷 67–71
<b>What lighting is available?</b>		
➔	Sensitivity (ISO Equivalency) .....	📷 52–53
➔	White Balance .....	📷 54–66
<b>What is the subject, and how will I compose the photograph?</b>		
➔	Focus .....	📷 72–83
<b>How important is background lighting to the photograph?</b>		
➔	Exposure: Metering .....	📷 84
<b>What is more important, shutter speed or aperture?</b>		
➔	Exposure: Exposure Mode .....	📷 85–93
<b>Is the subject very bright, very dark, or high contrast?</b>		
➔	Exposure: Exposure Compensation .....	📷 97
➔	Exposure: Bracketing .....	📷 98–105
<b>Will I need a flash?</b>		
➔	Flash Photography .....	📷 106–116
<b>Do I want to combine multiple exposures in a single photograph?</b>		
➔	Overlay/Multiple Exposure .....	📷 117–121
<b>How do I want to control the shutter?</b>		
➔	Interval Timer Photography .....	📷 122–126
➔	Self-Timer Mode .....	📷 127

# Using Camera Menus

## Basic Menu Operations

The next four sections involve settings that can be accessed via the camera menus. To view the menus, turn the camera on and press the **MENU** button.

### Choosing a Menu

There are five main menus: the playback menu, the shooting menu, the Custom Settings menu, the setup menu, and Recent Settings. When the menu button is pressed, the camera displays the last menu used. To select a different menu:

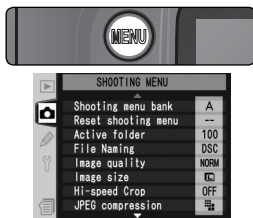

1

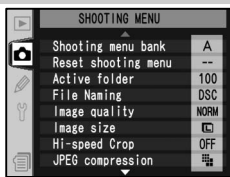

If menu item is highlighted, press **MENU**.

2

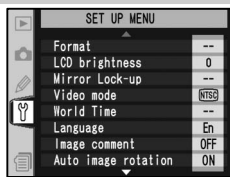
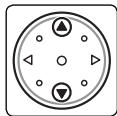

Select menu.

3



Position cursor in selected menu.

### Recent Settings

The Recent Settings () menu lists the eight most recently selected items in the shooting and Custom Settings menus. Items can be selected in the Recent Settings menu as described on the following page. Use this menu to access frequently-used options.

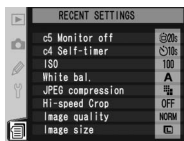

### Help

For help on menu options, press the **Q** button. A description of the currently selected option or menu will be displayed. Press the multi selector up or down to scroll the display.

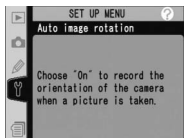

## Making a Selection

To modify settings for an item in the current menu:

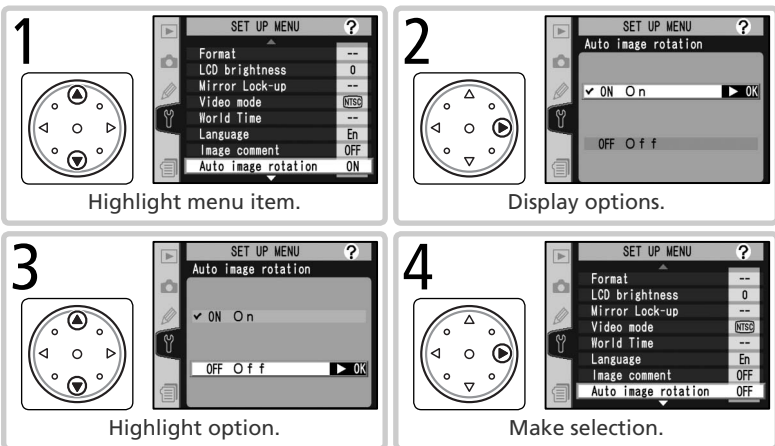

- To return to the previous UP MENU without making a selection, press the multi selector to the left.
- The selection for some options is made from a sub-menu. Repeat steps 3 and 4 to make a selection from a sub-menu.
- Some menu items are not available while images are being recorded to the memory card.
- Pressing the **ENTER** button or the center of the multi selector performs the same function as pressing the multi selector to the right. In some cases, a selection can only be made using **ENTER** button or the center of the multi selector.

## Exiting the Menus

To exit the menus, press the **MENU** button (if a menu option is highlighted, press the **MENU** button twice). You can also exit the menus by pressing the **▶** button to exit to playback mode or by turning the camera off. To exit the menus and focus the camera for the next shot, press the shutter-release button halfway.

# High-Speed Crop

## High-Speed Frame Advance

When high-speed crop is on, photographs will include only the area framed in the viewfinder high-speed crop (see right). Photographs can be recorded at up to eight frames per second, and more photographs can be taken before the memory buffer fills (📷 43).



High-speed crop

High-speed crop is turned on and off using the FUNC. button or the **Hi-speed Crop** item in the shooting menu.

Option	Description
<b>Off</b> (default)	High-speed crop off. Photographs include entire area visible in viewfinder.
<b>On</b>	High-speed crop on. High-speed crop indicator is displayed in top control panel and blinks in viewfinder. Corners of high-speed crop are displayed in viewfinder when focus area lights.

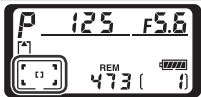

### The Hi-Speed Crop Menu

- 1 Highlight **Hi-speed Crop** in the shooting menu (📷 166) and press the multi selector to the right.
- 2 Highlight the desired option and press the multi selector to the right. The shooting menu will be displayed.

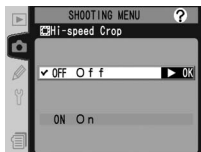
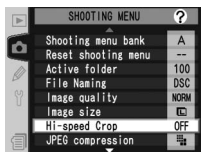

### 📷 Focus Areas

The two focus areas outside the high-speed crop are not available when high-speed crop is on (📷 74).

### 📷 Image Size

Selecting high-speed crop reduces image size (📷 48).

## The FUNC. Button

- 1 Select **Hi-speed Crop** for Custom Setting f4 (**FUNC. button**;  205).
- 2 Press the FUNC. button and rotate the main command dial. High-speed crop is on when the high-speed crop indicator is displayed in the top control panel and blinks in the viewfinder.

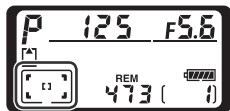
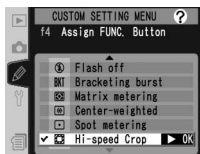

### "Busy"

If high-speed crop is turned on or off while pictures are being recorded to the memory card, **busy** will flash in the top control panel and no photographs can be taken until all pictures have been recorded or the original high-speed crop setting has been restored.

### Camera Off Display

If high-speed crop is on when the camera is turned off, the high-speed crop indicator will be displayed in the top control panel.

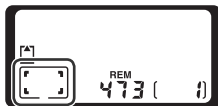



# Choosing a Shooting Mode

Single Frame, Continuous, Self-Timer, or Mirror Up

Shooting mode determines how the camera takes photographs: one at a time, in a continuous sequence, with a timed shutter-release delay, or with the mirror raised to enhance shutter response and minimize vibration.

Mode	Description
<b>S</b> Single frame	Camera takes one photograph each time shutter-release button is pressed. Access lamp will light while photo is recorded; next shot can be taken immediately if enough space remains in memory buffer.
<b>CL</b> Continuous low speed	While shutter-release button is held down, camera records 1–4 frames per second (1–7 fps when high-speed crop is on;  41). <sup>*</sup> Frame rate can be chosen using Custom Setting d1 ( <b>Shooting Speed</b> ;  194).
<b>CH</b> Continuous high speed	While shutter-release button is held down, camera records up to 5 frames per second (8 fps when high-speed crop is on;  41). <sup>*</sup>
 Self-timer	Use the self-timer for self-portraits or to reduce blurring caused by camera shake ( 127).
<b>M-UP</b> Mirror up	Press shutter-release button once to raise mirror, again to take photograph (shutter will be released automatically if shutter-release button is not pressed for 30s after mirror up). Mirror will be lowered after shutter is released. Choose this mode to minimize camera shake in situations in which the least camera movement can result in blurred photographs. Note that autofocus, metering, and framing can not be confirmed in the viewfinder while mirror is raised.

<sup>\*</sup> Average frame rate with continuous-servo AF, manual or shutter-priority auto exposure, a shutter speed of 1/250s or faster, and memory remaining in memory buffer. Number of pictures that can be stored in buffer depends on options selected for image quality and **Hi-speed crop** (see right; figures assume a sensitivity of ISO 100 equivalent).

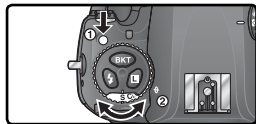

Quality	Hi-speed crop	
	Off	On
Uncompressed NEF+JPEG	16	28
Compressed NEF+JPEG	16	28
Uncompressed NEF	17	29
Compressed NEF	17	29
TIFF (RGB)	16	28
JPEG	22	35

To choose a shooting mode, press the mode dial lock release and turn the mode dial to the desired setting.



### The Memory Buffer

The camera is equipped with a memory buffer for temporary storage, allowing shooting to continue while photographs are being saved to the memory card. When the buffer is full, the shutter is disabled until enough data have been transferred to the memory card to make room for another photograph. In continuous mode, shooting will continue as long as the shutter-release button is held down, although the frame rate will drop once the buffer has filled.

While photographs are being recorded to the memory card, the access lamp next to the memory card slot will light. Depending on the number of the images in the buffer, recording may take from a few seconds to a few minutes. **Do not remove the memory card or remove or disconnect the power source until the access lamp has gone out.** If the camera is switched off while data remain in the buffer, the power will not turn off until all images in the buffer have been recorded. To turn the camera off without recording the images in the buffer, press the  button while turning the camera off (keep the  button pressed for at least one second after turning the camera off). If the battery is exhausted while images remain in the buffer, the shutter release will be disabled and the images transferred to the memory card.

The approximate time required to write the entire buffer to a 1 GB SanDisk SDCFH (Ultra II) card is as follows (sensitivity set to ISO 100 equivalent):

Quality	Hi-speed crop: Off	Hi-speed crop: On
Uncompressed NEF (RAW)+JPEG Basic (Large)	40s (16 frames)	50s (28 frames)
Uncompressed NEF (RAW)	40s (17 frames)	50s (29 frames)
TIFF RGB (Large)	530s (16 frames)	750s (28 frames)
JPEG Fine (Large)	20s (22 frames)	20s (35 frames)

### Buffer Size

The number of images that can be stored in the memory buffer at current settings is shown in the exposure-count displays in the viewfinder and top control panel while the shutter-release button is pressed.

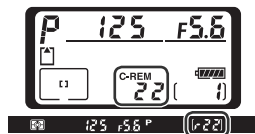

### d2—Maximum Shots 194

The maximum number of photographs that can be taken in a single burst can be limited to any amount between one and thirty-five.

# Image Quality and Size

*Making Effective Use of Memory*

Together, image quality and size determine how much space each photograph occupies on the memory card.

## Image Quality

The D2X supports the following image quality options (listed in descending order by image quality and file size):

Option	Description
<b>NEF (Raw) + JPEG Fine</b>	Two images are recorded, one NEF (RAW) image and one fine-quality JPEG image.
<b>NEF (Raw) + JPEG Normal</b>	Two images are recorded, one NEF (RAW) image and one normal-quality JPEG image.
<b>NEF (Raw) + JPEG Basic</b>	Two images are recorded, one NEF (RAW) image and one basic-quality JPEG image.
<b>NEF (Raw)</b>	Raw 12-bit data from the image sensor are saved directly to the memory card in Nikon Electronic Format (NEF).
<b>TIFF (RGB)</b>	Record uncompressed TIFF-RGB images at a bit depth of 8 bits per channel (24-bit color). Time needed to record images increases.
<b>JPEG Fine</b>	Record JPEG images at a compression ratio of roughly 1:4.
<b>JPEG Normal</b>	Record JPEG images at a compression ratio of roughly 1:8.
<b>JPEG Basic</b>	Record JPEG images at a compression ratio of roughly 1:16.

### **NEF (Raw)/NEF+JPEG**

NEF (RAW) images can only be viewed in PictureProject or in Nikon Capture 4 version 4.2 or later (📷 246). When photographs taken at **NEF (Raw) + JPEG Fine**, **NEF (Raw) + JPEG Normal**, or **NEF (Raw) + JPEG Basic** are viewed on the camera, only the JPEG image will be displayed. When photographs taken at these settings are deleted, both NEF and JPEG images will be deleted.

White balance bracketing can not be used with NEF (RAW) images. Selecting an NEF (RAW) option for image quality cancels white balance bracketing. White balance for NEF (RAW) images can be adjusted using Nikon Capture 4.

### **TIFF (RGB)**

About 30s are required to record a TIFF (RGB) image (1 GB SanDisk SDCFH (Ultra II) card; recording time varies with make of memory card).

Image quality can be set using the **Image quality** option in the shooting menu or by pressing the **QUAL** button and rotating the main command dial. Two options are available for controlling compression: **Raw compression** for NEF (RAW) images (📷 48) and **JPEG compression** for JPEG images (📷 47).

### The Image Quality Menu

- 1 Highlight **Image quality** in the shooting menu (📷 166) and press the multi selector to the right.
- 2 Highlight the desired option and press the multi selector to the right. The shooting menu will be displayed.

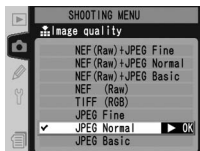
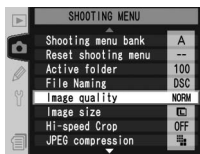

### The QUAL Button

Press the **QUAL** button and rotate the main command dial (note that **Raw compression** and **JPEG compression** can only be adjusted from the shooting menu). Image quality is displayed in the rear control panel and viewfinder sidebar:

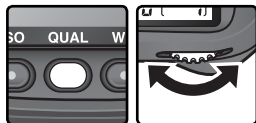

Option	Rear panel	Viewfinder
NEF (Raw) + JPEG Fine	RAW+FINE	R F
NEF (Raw) + JPEG Normal	RAW+ NORM	RN
NEF (Raw) + JPEG Basic	RAW+ BASIC	R B
NEF (Raw)	RAW	R
TIFF (RGB)	TIFF	T
JPEG Fine	FINE	F
JPEG Normal	NORM	N
JPEG Basic	BASIC	B



Rear control panel



Viewfinder

## The JPEG Compression Menu

The JPEG compression menu offers the following options for JPEG images:

Option	Description
<b>Size priority</b> (default)	Images are compressed to produce relatively uniform file size. Quality varies with scene recorded.
<b>Optimal quality</b>	Optimal image quality. File size varies with scene recorded.

The effects of these options are most pronounced with large image sizes (📷 48), high sensitivity (📷 52), complex scenes, image quality settings of **RAW+BASIC** or **BASIC**, or heavy sharpening (📷 67). To choose an option:

- 1 Highlight **JPEG compression** in the shooting menu (📷 166) and press the multi selector to the right.
- 2 Highlight the desired option and press the multi selector to the right. The shooting menu will be displayed. The selected option takes effect whenever image quality is set to **NEF (Raw) + JPEG Fine**, **NEF (Raw) + JPEG Normal**, **NEF (Raw) + JPEG Basic**, **JPEG Fine**, **JPEG Normal**, or **JPEG Basic**.

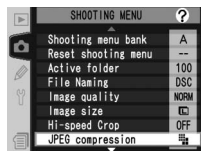

## File Names

Photographs are stored as image files with names of the form “DSC\_nnnn.xxx,” where nnnn is a four-digit number between 0001 and 9999 assigned automatically in ascending order by the camera, and xxx is one of the following three letter extensions: “NEF” for NEF images, “TIF” for TIFF-RGB, “JPG” for JPEG images, and “NDF” for Dust Off ref photos (📷 217–218). The NEF and JPEG files recorded at a setting of “NEF+JPEG” have the same file names but different extensions. Images recorded at a **Color space** setting of **AdobeRGB** (📷 69) have names that begin with an underbar (e.g., “\_DSC0001.JPG”). The “DSC” portion of the file name can be changed using the **File Naming** option in the shooting menu (📷 171).

## The Raw Compression Menu

The following options are available for NEF (RAW) images:

Option	Description
<b>NEF (Raw)</b> (default)	NEF images are not compressed.
<b>Comp. NEF (Raw)</b>	NEF images are compressed, reducing file size by about 40–50% percent with almost no effect on image quality.

1 Highlight **Raw compression** in the shooting menu (166) and press the multi selector to the right.

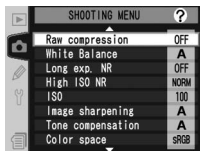

2 Highlight the desired option and press the multi selector to the right. The shooting menu will be displayed. The selected option takes effect whenever image quality is set to **NEF (Raw) + JPEG Fine, NEF (Raw) + JPEG Normal, NEF (Raw) + JPEG Basic, or NEF (Raw)**.



## Image Size

Image size is measured in pixels. Smaller sizes produce smaller files, making them suited to distribution via e-mail or inclusion in web pages. Conversely, the larger the image, the larger the size at which it can be printed without becoming noticeably “grainy.” Choose image size according to the space available on the memory card and the task at hand (note that image size varies depending on the setting selected for **Hi-speed Crop**; 41).

Option	Hi-speed crop: Off		Hi-speed crop: On	
	Size (pixels)	Print size (cm)*	Size (pixels)	Print size (cm)*
<b>Large</b>	4,288 × 2,848	54.5 × 36.2 (21" × 14")	3,216 × 2,136	40.8 × 27.1 (16" × 11")
<b>Medium</b>	3,216 × 2,136	40.8 × 27.1 (16" × 11")	2,400 × 1,600	30.5 × 20.3 (12" × 8")
<b>Small</b>	2,144 × 1,424	27.2 × 18.1 (11" × 7")	1,600 × 1,064	20.3 × 13.5 (8" × 5")

\* Approximate size when printed at 200 dpi.

Image size can be set using the **Image size** option in the shooting menu or by pressing the **QUAL** button and rotating the sub-command dial. Note that the option selected does not affect the size of NEF (RAW) images. When opened in PictureProject or Nikon Capture 4 version 4.2 or later, NEF images are 4,288×2,848 (high-speed crop off) or 3,216×2,136 (high-speed crop on) pixels in size.

### The Image Size Menu

- 1 Highlight **Image size** in the shooting menu (166) and press the multi selector to the right.
- 2 Highlight the desired option and press the multi selector to the right (note that the pixel size listed will vary to reflect the option currently selected for **Hi-speed Crop**). The shooting menu will be displayed.

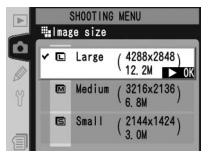
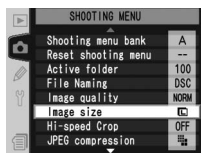

### The QUAL Button

Image size can also be set by pressing the **QUAL** button and rotating the sub-command dial. Image size is displayed in the rear control panel and in the viewfinder sidebar:

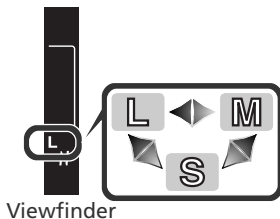
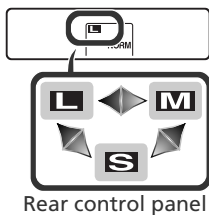
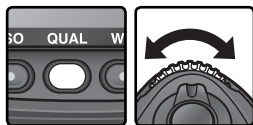

## Memory Card Capacity and Image Quality/Size

The following table shows the approximate number of pictures that can be stored on a 1 GB card at different image quality and size settings.

Image quality	Image size	Hi-speed crop: Off			Hi-speed crop: On		
		File size <sup>1</sup>	No. of images <sup>1</sup>	Buffer capacity <sup>2</sup>	File size <sup>1</sup>	No. of images <sup>1</sup>	Buffer capacity <sup>2</sup>
NEF + JPEG Fine <sup>3, 4, 5</sup>	L <sup>6</sup>	25.1 MB	36	16	14.2 MB	64	28
	M <sup>6</sup>	22.6 MB	41	16	12.8 MB	72	28
	S <sup>6</sup>	20.7 MB	45	16	11.8 MB	79	28
NEF + JPEG Normal <sup>3, 4, 5</sup>	L <sup>6</sup>	22.2 MB	41	16	12.6 MB	73	28
	M <sup>6</sup>	20.9 MB	44	16	11.9 MB	78	28
	S <sup>6</sup>	20.0 MB	47	16	11.4 MB	82	28
NEF + JPEG Basic <sup>3, 4, 5</sup>	L <sup>6</sup>	20.7 MB	45	16	11.8 MB	79	28
	M <sup>6</sup>	20.1 MB	47	16	11.4 MB	82	28
	S <sup>6</sup>	19.6 MB	48	16	11.2 MB	84	28
NEF (Raw) <sup>4</sup>	—	19.2 MB	49	17	10.9 MB	86	29
TIFF (RGB)	L	36.5 MB	26	16	20.5 MB	46	28
	M	21.2 MB	46	16	11.9 MB	83	28
	S	10.3 MB	104	16	5.8 MB	183	28
JPEG Fine <sup>5</sup>	L	5.9 MB	138	22	3.3 MB	244	35
	M	3.3 MB	244	22	1.9 MB	433	35
	S	1.5 MB	538	22	0.84 MB	919	35
JPEG Normal <sup>5</sup>	L	2.9 MB	274	22	1.7 MB	473	35
	M	1.7 MB	473	22	0.95 MB	822	35
	S	0.76 MB	1000	22	0.44 MB	1700	35
JPEG Basic <sup>5</sup>	L	1.5 MB	538	22	0.85 MB	919	35
	M	0.85 MB	919	22	0.49 MB	1500	35
	S	0.39 MB	1900	22	0.23 MB	3100	35

1 All figures are approximate. Size of JPEG files varies with scene recorded.

2 Maximum number of frames that can be stored in memory buffer. Drops when **Long Exp. NR** is on, when sensitivity is set to **HI-1** or **HI-2**, or when **High ISO NR** is on and Custom Setting b1 (**ISO auto**) is on or sensitivity is ISO 400 or higher.

3 Total for NEF and JPEG images.

4 Figures assume **Raw compression** is set to **NEF (Raw)**. Selecting **Comp. NEF (Raw)** decreases file size of NEF (RAW) images by approximately forty to fifty percent; although number of exposures remaining does not change, number of images that can be recorded increases.

5 Figures assume **JPEG compression** is set to **Size priority**. Selecting **Optimal quality** increases file size of JPEG images by up to eighty percent; number of images and buffer capacity drop accordingly.

6 Applies to JPEG images only. File size of NEF (RAW) images can not be changed.



### Number of Exposures Remaining

The number of exposures remaining shown in the exposure count displays in the control panel and viewfinder is only an approximation. The number of compressed NEF or JPEG images that can be stored on a memory card depends on the subject and composition of each photograph. In general, the more detailed the image, the larger the resulting file and the fewer the images that can be stored.

### Large-Capacity Memory Cards

When enough memory remains on the memory card to record a thousand or more pictures at current settings, the number of exposures remaining will be shown in thousands, rounded down to the nearest hundred (e.g., if there is room for approximately 1,260 exposures, the exposure count display will show 1.2 K).

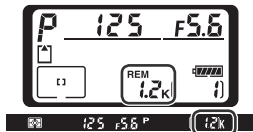

### d2—Maximum Shots 194

The maximum number of photographs that can be taken in a single burst can be limited to any amount between one and thirty-five.

# Sensitivity (ISO Equivalency)

Reacting Faster to Light

“Sensitivity” is the digital equivalent of film speed. The higher the sensitivity, the less light needed to make an exposure, allowing higher shutter speeds or smaller apertures.

Sensitivity can be set between values roughly equivalent to ISO 100 and ISO 800 in steps equivalent to  $\frac{1}{3}$ EV. Settings of **HI-1** and **HI-2** (respectively 1 EV and 2 EV over ISO 800) are available where high sensitivity is a priority. Sensitivity can be adjusted using the **ISO** option in the shooting menu or by pressing the **ISO** button and rotating the main command dial.

## The ISO Menu

1 Highlight **ISO** in the shooting menu (📷 166) and press the multi selector to the right.

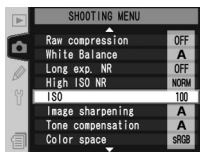

2 Highlight the desired option and press the multi selector to the right. The shooting menu will be displayed.

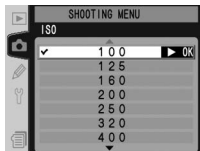

## The ISO Button

Sensitivity can also be set by pressing the **ISO** button and rotating the main command dial. Sensitivity is displayed in the control panels and viewfinder sidebar:



Top control panel



Rear control panel

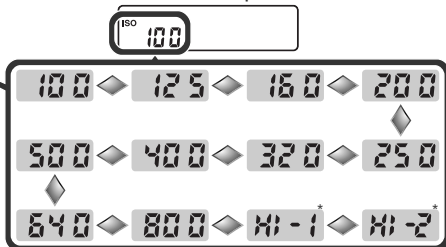

Viewfinder



\* Viewfinder display shows **H-1** and **H-2**.

**HI-1/HI-2**

The higher the sensitivity, the more likely pictures are to be subject to “noise” in the form of randomly-spaced, brightly-colored pixels. Photos taken at **HI-1** or **HI-2** will likely contain appreciable amounts of noise.

**High ISO NR (173)**

This option can be used to reduce noise at sensitivities of ISO 400 or more (this reduces the capacity of the memory buffer). Note that although noise reduction is always in effect at sensitivities of **HI-1** and **HI-2**, selecting **On** for **High ISO NR** will increase the amount of noise reduction performed.

**b1—ISO Auto (188)**

When **On** is selected for Custom Setting b1 (**ISO auto**), the camera will automatically vary sensitivity from the value selected by the user to help ensure optimum exposure. Sensitivity can not be set to **HI-1** or **HI-2** while **ISO auto** is on, and **On** can not be selected for **ISO auto** is when ISO is set to **HI-1** or **HI-2**.

**b2—ISO Step Value (189)**

Depending on the option selected for Custom Setting b2, sensitivity can also be set in increments equivalent to ½ or 1 EV.

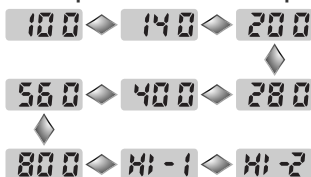







**ISO step value set to 1/2 step****ISO step value set to 1 step**

If possible, the current sensitivity setting is maintained when the step value is changed. If the current sensitivity setting is not available at the new step value, sensitivity will be rounded up to the nearest available setting.

**d5—Cntrl Panel/Finder>Rear Control Panel (196)**

If **Exposures remaining** is selected for **Cntrl panel/finder>Rear control panel** (Custom Setting d5), sensitivity will only be displayed in the rear control panel while the **ISO** button is pressed. If **ISO** is selected, sensitivity will be displayed except during voice memo recording and playback.

The color of light reflected from an object varies with the color of the light source. The human brain is able to adapt to changes in the color of the light source, with the result that white objects appear white whether seen in the shade, direct sunlight, or under incandescent lighting. Unlike the film used in film cameras, digital cameras can mimic this adjustment by processing images according to the color of the light source. This is known as “white balance.” For natural coloration, choose a white balance setting that matches the light source before shooting. The following options are available:

	Option	Approximate color temperature	Description
<b>A</b>	<b>Auto</b>	3,500–8,000 K	White balance adjusted automatically using color temperature measured by 1,005-pixel RGB sensor, image sensor, and ambient light sensor. For best results, use type G or D lens. With SB-800 or SB-600 Speedlight, white balance reflects conditions in effect when Speedlight fires.
	<b>Incandescent</b>	3,000 K	Use under incandescent lighting.
	<b>Fluorescent</b>	4,200 K	Use under fluorescent lighting.
	<b>Direct sunlight</b>	5,200 K	Use with subjects lit by direct sunlight.
	<b>Flash</b>	5,400 K	Use with Nikon Speedlights.
	<b>Cloudy</b>	6,000 K	Use in daylight under overcast skies.
	<b>Shade</b>	8,000 K	Use in daylight with subjects in the shade.
	<b>Choose color temp.</b>	2,500–10,000 K	Choose color temperature from list of values (  58).
<b>PRE</b>	<b>White balance preset</b>	—	Use subject, light source, or existing photograph as reference for white balance (  59).

Auto white balance is recommended with most light sources. If the desired results can not be achieved with auto white balance, choose an option from the list above or use preset white balance.

White balance can be set using the **White Balance** option in the shooting menu or by pressing the **WB** button and rotating the main command dial.

### The White Balance Menu

- 1 Highlight **White Balance** in the shooting menu (📷 166) and press the multi selector to the right.
- 2 Highlight the desired option and press the multi selector to the right. Selecting **Choose color temp.** displays a menu of color temperatures (📷 58), **White balance preset** a preset white balance menu (📷 59), other options a fine-tuning dialog (📷 56).

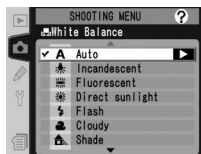
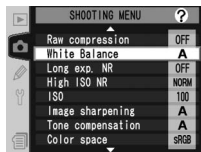

### The WB Button

White balance can also be set by pressing the **WB** button and rotating the main command dial. White balance is displayed in the rear control panel and viewfinder sidebar:

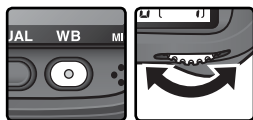

Rear control panel



Viewfinder



### 🔪 Studio Strobe Lighting

Auto white balance may not produce the desired results with studio strobe lighting. Choose a color temperature, use preset white balance, or set white balance to **Flash** and use fine tuning to adjust white balance.

### CSM e5—Auto BKT Set (📷 200)

When **WB bracketing** is selected for custom setting e5 (**Auto BKT set**), the camera will create several images each time the shutter is released. White balance will be varied with each image, “bracketing” the value currently selected for white balance.

## Fine-Tuning White Balance

At settings other than **☑** (**Choose color temp.**) and **PRE** (preset), white balance can be “fine tuned” to compensate for variations in the color of the light source or to introduce a deliberate “warm” or “cold” cast into an image. Higher settings can be used to lend images a bluish tinge or to compensate for light sources with a yellow or red cast, while lowering white balance can make photographs appear slightly more yellow or red or compensate for light sources with a blue cast. Adjustments can be made in the range +3 to -3 in increments of one. Except in **Fluorescent** mode, each increment is equivalent to about 10 mired.

White balance is fine tuned using the **White Balance** option in the shooting menu or by pressing the **WB** button and rotating the sub-command dial.

### The White Balance Menu

- 1 In the white balance menu (☰ 54), highlight an option other than **Choose color temp.** or **White balance preset** and press the multi selector to the right.
- 2 Press the multi selector up or down to choose the desired value and press the multi selector to the right. The shooting menu will be displayed.

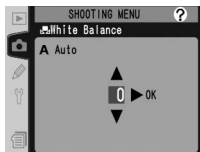

## Color Temperature

The perceived color of a light source varies with the viewer and other conditions. Color temperature is an objective measure of the color of a light source, defined with reference to the temperature to which an object would have to be heated to radiate light in the same wavelengths. While light sources with a color temperature in the neighborhood of 5,000–5,500 K appear white, light sources with a lower color temperature, such as incandescent light bulbs, appear slightly yellow or red. Light sources with a higher color temperature appear tinged with blue.

## The WB Button

Press the **WB** button and rotate the sub-command dial until the desired value is displayed in the rear control panel. At settings other than  $\pm 0$ , a  $\blacktriangleleft$  icon appears in the rear control panel and viewfinder sidebar.

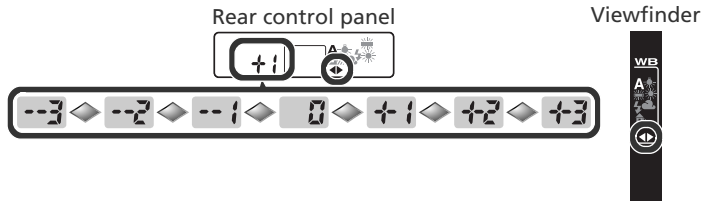

## Fine-Tuning and Color Temperature

Approximate color-temperatures for settings other than **A** (auto) are given below (values may differ from color temperatures given by photo color meters):

	Incandescent	Fluorescent*	Direct sunlight	Flash	Cloudy (daylight)	Shade (daylight)
+3	2,700K	2,700K	4,800K	4,800K	5,400K	6,700K
+2	2,800K	3,000K	4,900K	5,000K	5,600K	7,100K
+1	2,900K	3,700K	5,000K	5,200K	5,800K	7,500K
$\pm 0$	3,000K	4,200K	5,200K	5,400K	6,000K	8,000K
-1	3,100K	5,000K	5,300K	5,600K	6,200K	8,400K
-2	3,200K	6,500K	5,400K	5,800K	6,400K	8,800K
-3	3,300K	7,200K	5,600K	6,000K	6,600K	9,200K

\* The size of the increments for **Fluorescent** reflects the wide variations in color temperature among the many different types of fluorescent light source, ranging from low-temperature stadium lighting to high-temperature mercury-vapor lamps.

## "Mired"

Any given change in color temperature produces a greater difference in color at low color temperatures than it would at higher color temperatures. For example, a change of 1000K produces a much greater change in color at 3000K than at 6000K. Mired, calculated by multiplying the inverse of the color temperature by  $10^6$ , is a measure of color temperature that takes such variation into account, and as such is the unit used in color-temperature compensation filters. E.g.:

- 4000K – 3000K (a difference of 1000K) = 83 mired
- 7000K – 6000K (a difference of 1000K) = 24 mired

## Choosing a Color Temperature

Choose a setting of **[K] (Choose color temp.)** to select the color temperature from thirty-one predetermined values ranging from 2,500K to 10,000K in increments of roughly 10 mired (note that the desired results will not be obtained with flash or fluorescent lighting). Color temperature can be selected in the white-balance menu or with the **WB** button and sub-command dial.

### The White Balance Menu

- In the white balance menu (**[K] 54**), highlight an **Choose color temp.** and press the multi-selector to the right.
- Highlight the desired color temperature and press the multi-selector to the right. The shooting menu will be displayed.

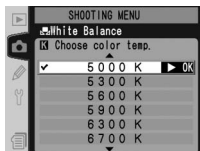
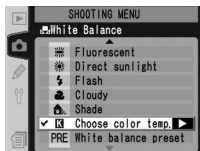

### The WB Button

At a setting of **[K] (Choose color temp.)**, color temperature can be selected by pressing the **WB** button and rotating the sub-command dial. The color temperature is displayed in the rear control panel:

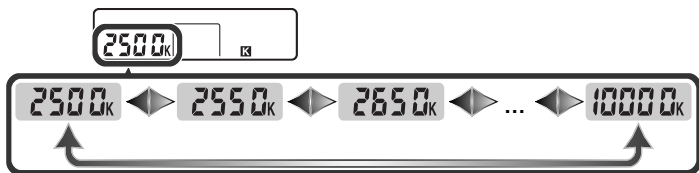
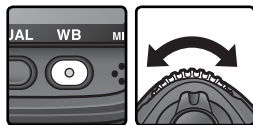

### Take Test Shots

Take a test shot to determine if the selected value is appropriate to the light source.



## Preset White Balance

Preset white balance is used to record and recall custom white balance settings for shooting under mixed lighting or to compensate for light sources with a strong color cast. Four options are available for setting preset white balance:

### Recording New Values with the Camera

- (1) Frame a neutral gray or white object and press the shutter-release button to measure a value for white balance (📷 60).
- (2) Measure white balance with the ambient light sensor (📷 60).

### Copying Values from Existing Photographs

- (3) Copy white balance from another image on the memory card (📷 65).
- (4) Copy white balance from Nikon Capture 4 version 4.2 or later (📷 66).

The camera can store up to five values for preset white balance in presets d-0–d-4. White balance values recorded with options (1) and (2) are stored in preset d-0. To prevent this value from being replaced the next time white balance is measured, the value stored in d-0 can be copied to presets d-1–d-4 for long-term storage (📷 66). White balance values copied using options (3) and (4) are also stored in presets d-1–d-4. A descriptive comment can be added to any white balance preset (📷 64).

**d-0**



Stores last value measured for white balance (📷 60).

**d-1–d-4**

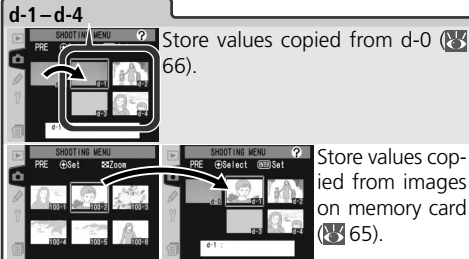

Store values copied from d-0 (📷 66).

Store values copied from images on memory card (📷 65).

Store values created in Nikon Capture 4 version 4.2 or later (available separately; 📷 66).

### White Balance Presets

Changes to white balance presets apply to all shooting menu banks (📷 167). A confirmation dialog will be displayed if the user attempts to change a white balance preset created in another shooting menu bank (no warning is displayed for preset d-0).

## Measuring a Value for White Balance

White balance can be measured with reference to a neutral gray object or by measuring the color of the light source. The new value for white balance is automatically stored in preset d-0.

Reference	Description
Neutral gray object	Neutral gray or white object is placed under lighting that will be used in final photograph and white balance is measured using both 1,005-pixel RGB sensor and main image sensor. Use for flash photography or when the subject and camera are under different lighting. In studio settings, 18% diffusion panel can be used to make reference object appear gray.
Light source	Color of light source is measured by sensor on camera pentaprism and white balance adjusted to produce natural coloration without reference object. Use when subject is under same lighting as camera.

- 1 Press the **WB** button and rotate the main command dial until **PRE** is displayed in the rear control panel or viewfinder sidebar.



If the new value for preset white balance will be used immediately, select preset d-0 by pressing the **WB** button and rotating the sub-command dial until d-0 is displayed in the rear control panel (63). Otherwise there is no need to select d-0 when measuring a new value for white balance.

- 2 Release the **WB** button briefly and then press the button until the **PRE** icon in the rear control panel and viewfinder sidebar start to flash. A blinking **P-r-E** will also appear in the top control panel and viewfinder frame-count displays.

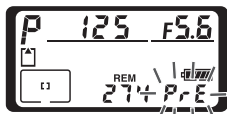

Top control panel

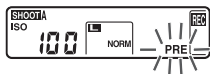

Rear control panel



Viewfinder

- 3 To measure white balance using a neutral gray or white object...  
 ...frame the reference object so that it fills the viewfinder and press the shutter-release button all the way down. The camera will measure a value for white balance and store it in preset d-0. No photograph will be recorded; white balance can be measured accurately even when the camera is not in focus.



#### To measure the color of the light source...

...make sure that the ambient light sensor is lit by the light source and press the FUNC. button. The camera will calculate a value for white balance and store it in preset d-0.



To exit without measuring a new value for white balance, press the **WB** button.

#### Exposure Mode

Preset white balance can be measured in all exposure modes. When using a reference object to set white balance, do not alter exposure from the value suggested by the camera.

4 If the camera was able to measure a value for white balance, **Good** will flash for about three seconds in the control panels, while the viewfinder will show a flashing **Gd**.

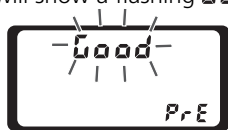

Top control panel



Rear control panel



Viewfinder

If lighting is too dark or too bright, or if some types of artificial lighting are used when measuring white balance using the ambient light sensor, the camera may be unable to measure white balance. A flashing **noGd** will appear in the control panels and viewfinder for about three seconds. Return to Step 3 and measure white balance again. If the camera is unable to measure white balance using the ambient light sensor, try measuring white balance using a neutral gray or white reference object.

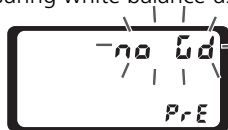

Top control panel



Rear control panel



Viewfinder

The new value for white balance will be stored in preset d-0, automatically replacing the previous value for this preset (no confirmation dialog will be displayed). If white balance was set using a reference object, a thumbnail will be displayed in the preset white balance list. Presets measured using the ambient light sensor are marked by a  icon.



To use the new value for white balance, select preset d-0 (if no value has been measured for white balance before d-0 is selected, white balance will be set to a color temperature of 5,200K, the same as **Direct sunlight**). The new white balance value will remain in preset d-0 until white balance is measured again. By copying preset d-0 to one of the other presets before measuring a new value for white balance, up to five white balance values can be stored ( 66).

## Selecting a White Balance Preset

To set white balance to a preset value:

- 1 Highlight **White balance preset** in the white balance menu (54) and press the multi-selector to the right. The menu shown at right will be displayed. (To return to the shooting menu, press the MENU button.)
- 2 Presets are identified by an icon or thumbnail, a name (d-0–d-4), and a comment. Press the multi-selector up, down, left, or right to highlight the desired preset. To select the highlighted preset and return to shooting mode without completing steps 3–5, press the **EXIT** button.
- 3 Press the center of the multi-selector to display the menu shown at right. To view options for other presets, highlight the name of the current preset (d-0–d-4) and press the multi-selector right.

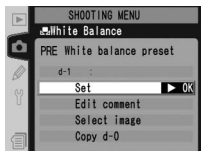

### Selecting a White Balance Preset: the WB Button

At a setting of **PRE (White balance preset)**, presets can also be selected by pressing the **WB** button and rotating the sub-command dial. The current preset is displayed in the rear control panel while the **WB** button is pressed.

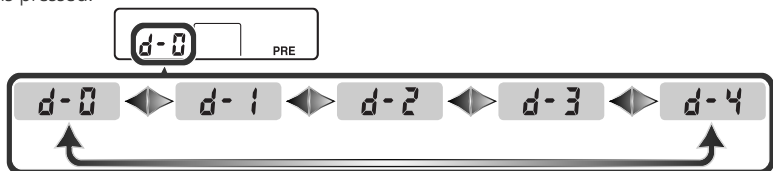

4 Press the multi selector up or down to highlight **Set**.

5 Press the multi selector to the right to set white balance to the value stored in the selected preset and return to the shooting menu.

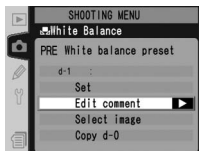
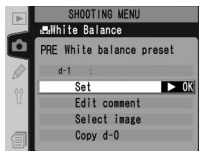
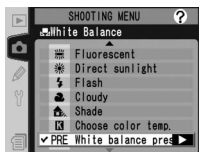
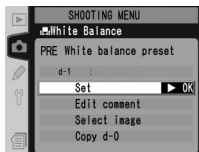

### Entering a Comment

To enter a descriptive comment of up to thirty-six characters for a selected white balance preset, highlight the preset in the thumbnail display and press the center of the multi selector as described in steps 1–3 on the previous page. The menu shown at right will be displayed.



1 Press the multi selector up or down to highlight **Edit comment**.

2 Press the multi selector to the right to display the text edit dialog. Edit the comment as described on page 213.

3 Press the **ENTER** button to return to the thumbnail display.

## Copying White Balance from a Photograph (d-1–d-4 Only)

To copy a value for white balance from a photograph on the memory card to a selected preset (d-1–d-4 only), highlight the preset in the thumbnail display and press the center of the multi-selector as described in steps 1–3 on page 63. The menu shown at right will be displayed.

- 1 Press the multi selector up or down to highlight **Select image**.
- 2 Press the multi selector to the right to display the photographs on the memory card. Only photographs taken with the D2X will be displayed; other images can not be selected.
- 3 Press the multi selector up, down, left, or right to highlight the desired image. To view the highlighted image full frame, press the  button. Press the  button again to return to the thumbnail list.
- 4 Press the center of the multi selector to copy the white balance value for the highlighted photograph to the selected preset and return to the thumbnail display. If the highlighted photograph has a comment, the comment will be copied to the comment for the selected preset.

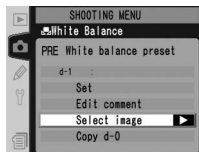
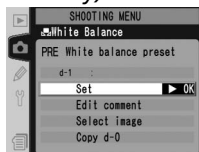

## Copying White Balance from d-0 to Presets d-1–d-4

To copy a measured value for white balance from d-0 to any of the other presets (d-1–d-4), highlight the destination preset in the thumbnail display and press the center of the multi selector as described in steps 1–3 on page 63. The menu shown at right will be displayed.

- 1 Press the multi selector up or down to highlight **Copy d-0**.
- 2 Press the multi selector to the right to copy white balance from d-0 to the selected preset and return to the thumbnail display. If comment has been created for d-0, the comment will be copied to the comment for the selected preset.

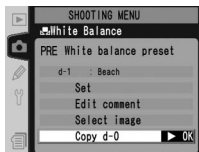
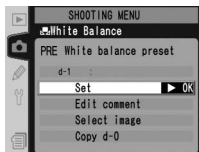

### Nikon Capture 4

Nikon Capture 4 version 4.2 or later (available separately) can be used to edit white balance when RAW photographs taken with the D2X are displayed on a computer. The edited value can be copied directly to a white balance preset while the camera is connected to a computer, or the image can be saved to the camera memory card and the white balance value copied using the **Select image** option in the preset menu. Any comments created with Nikon Capture 4 will also be copied to the comment for the selected preset. See the Nikon Capture 4 manual for details.



This section describes settings that can only be adjusted from the shooting menu (📷 166).

### Making Edges More Distinct: *Image Sharpening*

When a photograph is taken, the camera automatically processes the image to increase the distinction between light and dark areas, making the picture appear sharper. The **Image sharpening** menu controls the amount of sharpening performed.

Option	Description
<b>A</b> Auto (default)	The camera automatically adjusts sharpening according to the subject and how other camera settings are adjusted. Amount of sharpening varies from shot to shot, even in scenes of same type; to take multiple shots with same sharpening, choose different setting. For best results, use a type G or D lens.
◊0 <b>Normal</b>	Camera sharpens all images the same standard amount.
◊-2 <b>Low</b>	Images are sharpened less than the standard amount.
◊-1 <b>Medium low</b>	Images are sharpened slightly less than the standard amount.
◊+1 <b>Medium high</b>	Images are sharpened slightly more than the standard amount.
◊+2 <b>High</b>	Images are sharpened more than the standard amount.
📷 <b>None</b>	Images are not sharpened.

**1** Highlight **Image sharpening** in the shooting menu (📷 166) and press the multi selector to the right.

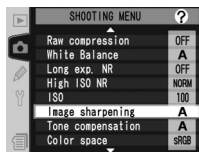

**2** Highlight the desired option and press the multi selector to the right. The shooting menu will be displayed.

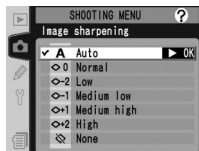

## Adjusting Contrast: Tone Compensation

As photographs are saved to the memory card, they are processed to adjust the distribution of tones in the image, enhancing contrast. Tone compensation is performed by means of tone curves that define the relationship between the distribution of tones in the original image and the compensated result. The **Tone compensation** menu controls the type of curve used.

Option	Description
<b>A</b> <b>Auto</b> (default)	Camera automatically optimizes contrast by selecting the appropriate curve. Curve varies from shot to shot, even in scenes of same type; to take multiple shots with same curve, choose different setting. For best results, use a type G or D lens.
<b>0</b> <b>Normal</b>	Camera uses same standard curve for all images. Suited to most scenes, whether dark or bright.
<b>-</b> <b>Less contrast</b>	Produces “softer” images. Prevents highlights on portrait subjects from being “washed out” in direct sunlight.
<b>+</b> <b>More contrast</b>	Choose this curve to preserve detail in misty landscapes and other low-contrast subjects.
<b>Ⓢ</b> <b>Custom</b>	Nikon Capture 4 version 4.2 or later (available separately) can be used to define a custom tone curve and download it to the camera. Choose <b>Custom</b> to select this user-defined curve. If no custom curve has been created, this option is equivalent to <b>Normal</b> .

**1** Highlight **Tone compensation** in the shooting menu (166) and press the multi selector to the right.

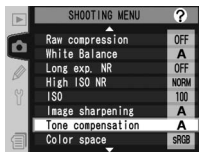

**2** Highlight the desired option and press the multi selector to the right. The shooting menu will be displayed.



## Suiting Colors to a Workflow: Color Space

The color space determines the gamut of colors available for color reproduction. Choose a color space according to how photographs will be processed on leaving the camera.

Option	Description
sRGB sRGB (default)	Choose for photographs that will be printed or used “as is,” with no further modification. Color mode II is not available (🔥 70).
Adobe AdobeRGB	This color space is capable of expressing a wider gamut of colors than sRGB, making it the preferred choice for images that will be extensively processed or retouched.

1 Highlight **Color space** in the shooting menu (🔍 166) and press the multi selector to the right.

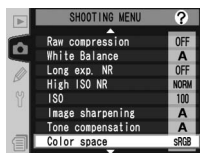

2 Highlight the desired option and press the multi selector to the right. The shooting menu will be displayed.

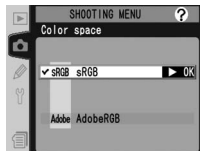

### Color Space

sRGB is recommended when taking photographs that will be printed without modification or viewed in applications that do not support color management, or when taking photographs that will be printed with ExifPrint, the direct printing option on some household printers, or kiosk printing or other commercial print services. Adobe RGB photographs can also be printed using these options, but colors will not be as vivid.

JPEG photographs taken in the Adobe RGB color space are Exif 2.21 and DCF 2.0 compliant; applications and printers that support Exif 2.21 and DCF 2.0 will select the correct color space automatically. If the application or device does not support Exif 2.21 and DCF 2.0, select the appropriate color space manually. An ICC color profile is embedded in TIFF photographs taken in the Adobe RGB color space, allowing applications that support color management to automatically select the correct color space. For more information, see the documentation provided with the application or device.

## Matching Colors to the Subject: *Color Mode*

Much as film cameras offer a choice of films for different subjects, the D2X offers a choice of color modes with subtly different palettes.

Option	Description
<b>I</b> (default)	Choose for portrait shots.
<b>II</b>	Choose for photographs that will be extensively processed or retouched. This option is available only when <b>AdobeRGB</b> is selected for <b>Color space</b> .
<b>III</b>	Choose for nature or landscape shots.

**1** Highlight **Color mode** in the shooting menu (166) and press the multi selector to the right.

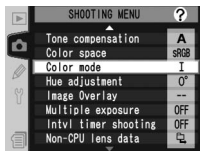

**2** Highlight the desired option and press the multi selector to the right. The shooting menu will be displayed.

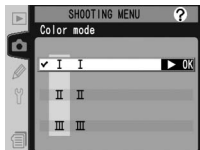

### Mode II

If **sRGB** is chosen for **Color space** when **Color mode** is set to Mode II, **Color mode** will be reset to the mode in effect when **sRGB** was last selected.

### Nikon Software

Nikon Capture 4 version 4.2 or later (available separately) and PictureProject automatically select the correct color space when opening photographs created with the D2X.

## Controlling Color: Hue Adjustment

Hue can be adjusted in the range about  $-9^\circ$  to  $+9^\circ$  in increments of  $3^\circ$ . If red is taken as the starting color, raising hue above  $0^\circ$  (the default setting) would introduce a yellow cast, making colors that would be red at a setting of  $0^\circ$  appear increasingly orange. Lowering hue below  $0^\circ$  would introduce a blue cast, making colors that would be red at a setting of  $0^\circ$  appear increasingly purple.

- 1 Highlight **Hue adjustment** in the shooting menu (📷 166) and press the multi selector to the right.
- 2 Highlight the desired option and press the multi selector to the right. The shooting menu will be displayed.



### 📷 Hue

The RGB color model used in digital photographs reproduces colors using differing amounts of red, green, and blue light. By mixing two colors of light, a variety of different colors can be produced. For example, red combined with a small amount of green light produces orange. If red and green are mixed in equal amounts, yellow results, while a smaller amount of red produces a yellow green. Mixing different amounts of red and blue light produces colors ranging from a reddish purple through purple to navy, while mixing different amounts of green and blue light produces colors ranging from emerald to turquoise. (Adding a third color of light results in lighter hues; if all three mixed in equal amounts, the results range from white through gray.) When this progression of hues is arranged in a circle, the result is known as a color wheel.

This section describes the options that control how your camera focuses: focus mode, focus-area selection, and AF-area mode.

## Focus Mode

Focus mode is controlled by the focus mode selector on the front of the camera. There are two *autofocus* (AF) modes, in which the camera focuses automatically when the shutter-release button is pressed halfway, and one *manual* focus mode, in which focus must be adjusted manually using the focusing ring on the lens:

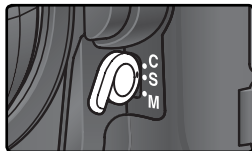

Option	Description
<b>S</b> Single-servo AF	Camera focuses when shutter-release button is pressed halfway. Focus locks when in-focus indicator (●) appears in viewfinder, and remains locked while shutter-release button is pressed halfway ( <i>focus lock</i> ). Shutter can only be released when in-focus indicator is displayed ( <i>focus priority</i> ). If subject was moving when shutter-release button was pressed halfway, camera will track subject until focusing is complete and the shutter can be released ( <i>predictive focus tracking</i> ; 73). If subject stops moving before shutter is released, in-focus indicator will appear in viewfinder and focus will lock at this distance.
<b>C</b> Continuous- servo AF	Camera focuses continuously while shutter-release button is pressed halfway. If subject moves, focus will be adjusted to compensate ( <i>predictive focus tracking</i> ; 73). Photographs can be taken whether or not camera is in focus ( <i>release priority</i> ).
<b>M</b> Manual	Camera does not focus automatically; focus must be adjusted manually using the lens focusing ring. If maximum aperture of lens is f/5.6 or faster, viewfinder focus indicator can be used to confirm focus ( <i>electronic range finding</i> ), but photographs can be taken at any time, whether or not camera is in focus.

Choosing single-servo AF ensures a sharp, focused image. Continuous-servo AF may be a better choice with erratically-moving subjects. Manual focus is recommended when the camera is unable to focus using autofocus.

## The AF-ON Buttons

For the purpose of focusing the camera, pressing either of the **AF-ON** buttons has the same effect as pressing the shutter-release button halfway (the **AF-ON** button for vertical shooting can only be used when the shutter-release button for vertical shooting is unlocked).

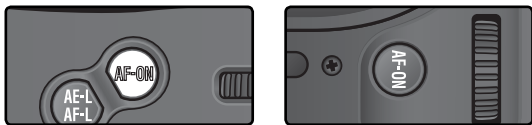

## Predictive Focus Tracking

If the camera autofocus system detects that the subject is moving when the shutter-release button is pressed halfway, it will automatically initiate predictive focus tracking. If the subject is moving toward or away from the camera, the camera will track focus while attempting to predict where the subject will be when the shutter is released. In single-servo autofocus, the camera will initiate predictive focus tracking if the subject was moving when the shutter-release button was pressed halfway. Focus will lock when the subject stops moving. In continuous-servo AF, the camera will also initiate predictive focus tracking if the subject starts moving after the shutter-release button is pressed halfway. Focus will not lock when the subject stops moving.

Predictive focus tracking is not available in manual focus mode.

## a1—AF-C Mode Priority 182)

If **Focus** is selected for Custom Setting a1 (**AF-C mode priority**), photographs can be taken in continuous servo-AF only when the camera is in focus. Select **FPS rate + AF** for improved focus during continuous shooting.

## a2—AF-S Mode Priority 182)

If **Release** is selected for Custom Setting a2 (**AF-S mode priority**), photographs can be taken in single servo-AF even when the camera is not in focus.

## a5—AF Activation 185)

If **AF-ON only** is selected for Custom Setting a5 (**AF activation**), the camera will only focus when one of the **AF-ON** buttons is pressed, not when the shutter-release button is pressed halfway.



## a8—Vertical AF-ON 187)

Custom Setting a8 (**Vertical AF-ON**) controls whether the **AF-ON** button for vertical shooting is used to initiate autofocus, select the focus area, or both.

## c2—AE-L/AF-L 192)

If desired, the **AE-L/AF-L** button can perform the same function as the **AF-ON** button.

## Focus Area Selection

The D2X offers a choice of eleven focus areas that together cover a wide area of the frame. The focus area can be selected manually, allowing photographs to be composed the main subject positioned almost anywhere in the frame, or automatically to ensure that the subject closest to the camera is always in focus regardless of where it is the frame (closest-subject priority;  77). Group dynamic-AF can be used to focus on the closest subject in a selected area of the frame ( 77).

To select the focus area, rotate the focus selector lock. The multi selector can then be used to select the focus area. The selected focus area is displayed in the top control panel and is highlighted briefly in the viewfinder.

To select the center focus area (or focus area group) at any time, press the center of the multi selector.

The focus selector lock can be rotated to the locked position following selection to prevent the selected focus area from changing when the multi selector is pressed.

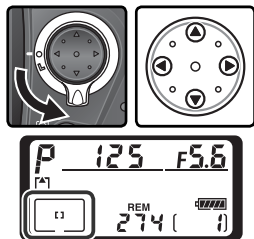

### High-Speed Crop

The two focus areas outside the high-speed crop are not available when high-speed crop is on ( 41).

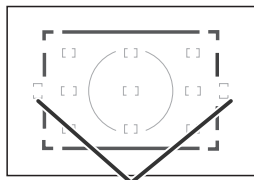

Focus areas not available when high-speed crop is on

### Focus Area Selection

The focus area can not be changed during playback or while menus are displayed.



## Focus Area Selection for Portrait (Tall) Orientation Photographs

If the shutter-release button for vertical shooting is unlocked, the focus area can also be selected by pressing the **AF-ON** button for vertical shooting and rotating the sub-command dial for vertical shooting. The selected focus area is displayed in the top control panel and is highlighted briefly in the viewfinder.

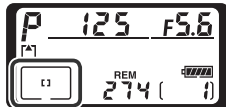

	10	
8	9	11
7	1	2
6	4	3
	5	

Rotate the sub-command dial clockwise to cycle endlessly through focus areas in the order shown at right, counter-clockwise to cycle through focus areas in the reverse order. Focus areas 5 and 10 are not available when high-speed crop is on.

### **a6—Focus Area Illum** 186

Custom Setting a6 (**Focus area illum**) controls how long the focus area is illuminated in the viewfinder after selection and whether focus areas are displayed in manual focus mode or continuous shooting mode.

### **a7—Focus Area** 187

This option can be used to set focus area selection to “wrap around.”

### **a8—Vertical AF-ON** 187

Custom Setting a8 (**Vertical AF-ON**) controls whether the **AF-ON** button for vertical shooting is used to initiate autofocus, select the focus area, or both.

### **f1—Center Button > Shooting Mode** 202

Depending on the option selected for **Center button > Shooting mode** (Custom Setting f1), pressing the center of the multi selector will have no effect or will illuminate the selected focus area.

## Autofocus

When the focus mode selector is set to **S** (single-servo autofocus) or **C** (continuous-servo autofocus), the camera focuses automatically when the shutter-release button is pressed halfway. This section describes focus options that are only available in single- and continuous-servo AF.

### AF-Area Mode

AF-area mode determines how the focus area is selected in autofocus mode. To select the AF-area mode, rotate the AF-area mode selector. The selected mode is shown by an icon in the top control panel (see following page).



### Manual Focus

Single-area AF is automatically selected when manual focus is used.

### The Top Control Panel

The selected focus area or group of focus areas is shown in the top control panel in single-area AF, dynamic-area AF, and group dynamic-AF. The illustrations in the “Icon” column show the display when the center focus area or focus area group is selected. The top control panel display does not show the focus area selected by the camera for dynamic-area AF with closest subject priority.

### CSM a1—AF-C Mode Priority (182)

In focus mode **C** (continuous-servo autofocus) photographs can be taken even when the camera is not in focus (*release priority*). To ensure that the camera is in focus when the picture is taken, choose **Focus** for Custom Setting a1 (**AF-C mode priority**). Select **FPS rate + AF** for improved focus during continuous shooting.

### CSM a2—AF-S Mode Priority (182)















In focus mode **S** (single-servo autofocus) photographs can be taken only when the camera is in focus (*focus priority*). To allow photographs to be taken regardless of whether or not the camera is in focus, choose **Release** for Custom Setting a2 (**AF-S mode priority**).

### CSM a3—Group Dynamic AF (183)









This option controls how focus areas are grouped in group dynamic-AF mode and whether the camera tracks the subject in the center focus area of the selected group.

### CSM a4—Lock-On (185)

This option controls whether the camera immediately adjusts focus to track a subject when the distance to the subject changes drastically.

Mode	Icon	Description
 Single-area AF		User selects focus area manually; camera focuses on subject in selected focus area only. Use for relatively static compositions with subjects that will stay in selected focus area. Focus areas outside high-speed crop can not be selected when high-speed crop is on (41).
 Dynamic-area AF		User selects focus area manually, but camera uses information from multiple focus areas to determine focus. If subject leaves selected focus area even briefly, camera will focus based on information from other focus areas (focus area selected in viewfinder does not change). Use when following erratically moving subjects and in other situations in which it is difficult to keep subject in selected focus area. <ul style="list-style-type: none"> <li>When high-speed crop is on (41), focus areas outside high-speed crop can not be selected, and camera will not use these areas to determine focus.</li> </ul>
 Group dynamic-AF		User chooses focus area group (see right). Camera focuses on center of selected group; if subject leaves focus area even briefly, camera focuses based on information from other focus areas in same group. Use when subject is moving erratically but place of subject in overall composition is known. <div style="display: flex; justify-content: space-around; align-items: center;"> <div style="text-align: center;">                           Top                     </div> <div style="text-align: center;">                           Left                     </div> <div style="text-align: center;">                           Center                     </div> <div style="text-align: center;">                           Right                     </div> </div> <div style="text-align: center; margin-top: 10px;">                           Bottom                     </div> <ul style="list-style-type: none"> <li>When high-speed crop is on (41), left and right focus-area groups do not include focus areas outside high-speed crop.</li> </ul> <div style="display: flex; justify-content: space-around; align-items: center; margin-top: 10px;"> <div style="text-align: center;">                           Left                     </div> <div style="text-align: center;">                           Right                     </div> </div>
 Dynamic-area AF with closest subject priority		Camera automatically selects focus area containing subject closest to camera. Prevents out-of-focus shots when photographing erratically moving subjects. Focus area can not be selected manually, and focus areas are not displayed in viewfinder or top control panel. Camera may be unable to select focus area containing closest subject when telephoto lens is used or subject is poorly lit. Single-area AF is recommended in these cases. <ul style="list-style-type: none"> <li>When high-speed crop is on (41), camera will not select focus areas outside high-speed crop.</li> </ul>

 Summary of Autofocus Options

Focus mode	AF-area mode	Control-panel display	Focus-area selection
AF-S	Single-area AF		Manual
	Dynamic-area AF		Manual
	Group dynamic-AF		Manual (camera focuses on center focus area of selected group)
	Dynamic-area AF with closest-subject priority		Automatic
AF-C	Single-area AF		Manual
	Dynamic-area AF		Manual
	Group dynamic-AF		Manual (camera focuses on center focus area of selected group)
	Dynamic-area AF with closest-subject priority		Automatic



How it works	When to use it
Camera focuses on subject in selected focus area. Focus will remain locked while shutter-release button is pressed halfway.	Use with static subjects when time is available to compose photo.
Camera focuses on subject in selected focus area. If subject moves before camera has focused, camera will focus based on information from other focus areas. Focus will remain locked while shutter-release button is pressed halfway.	Use with static subjects when time is available to compose photo.
As above, except camera focuses on subject in center focus area of selected group. If subject moves before camera has focused, camera will focus based on information from other focus areas in same group.	Use when sure of subject's place in overall composition but unsure of its exact position.
As above, except that camera selects focus area containing subject closest to camera. If subject moves before camera has focused, camera will focus based on information from other focus areas.	Use when sure that subject will be closest object to camera but unsure where it will appear in final composition.
Camera continues to focus on subject in selected focus area while shutter-release button is pressed halfway.	Use with moving subjects that can be continuously framed in single focus area.
Camera focuses on subject in selected focus area. While shutter-release button is pressed halfway, camera tracks subject as it moves from one focus area to the next.	Use with subjects that are moving unpredictably.
As above, except camera focuses on subject in center focus area of selected group.	Use when sure of moving subject's place in overall composition but unsure of its exact position.
As above, except that camera selects focus area containing subject closest to camera.	Use with erratically moving subjects when you know subject will be closest object to camera.

## Focus Lock

Focus lock can be used to change the composition after focusing, making it possible to focus on a subject that will not be in a focus area in the final composition. It can also be used when the autofocus system is unable to focus (👁 82).

In single-servo AF, focus locks automatically when the in-focus indicator (●) appears in the viewfinder. In continuous-servo AF, focus must be locked manually using the **AE-L/AF-L** button. To recompose a photograph using focus lock:

- 1 Position the subject in the selected focus area and press the shutter-release button halfway to initiate focus.

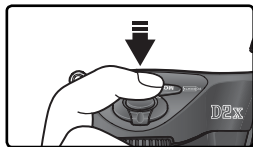
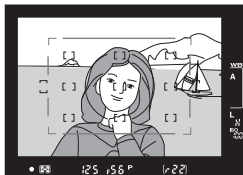

- 2 Check that the in-focus indicator (●) appears in the viewfinder.

### Single-servo AF

Focus will lock automatically when the in-focus indicator appears, and remain locked until you remove your finger from the shutter-release button. Focus can also be locked by pressing the **AE-L/AF-L** button (see below).

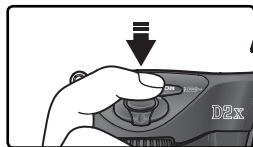

### Continuous-servo AF

Press the **AE-L/AF-L** button to lock both focus and exposure. Focus will remain locked while the **AE-L/AF-L** button is pressed, even if you later remove your finger from the shutter-release button.

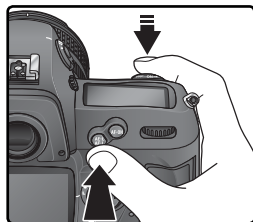

### 3 Recompose the photograph and shoot.

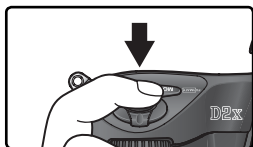
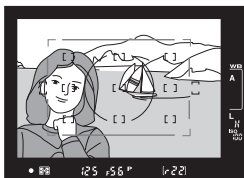

In single-servo AF, focus will remain locked between shots as long as the shutter-release button is kept pressed halfway, allowing several photographs in succession to be taken at the same focus setting. Focus will also remain locked between shots while the **AE-L/AF-L** button is pressed.

Do not change the distance between the camera and the subject while focus lock is in effect. If the subject moves, focus again at the new distance.

#### **c2—AE-L/AF-L** **192**

This option controls whether the **AE-L/AF-L** button locks focus and exposure (the default setting), focus only, or exposure only.

## Getting Good Results with Autofocus

Autofocus does not perform well under the conditions listed below. If the camera is unable to focus using autofocus, use manual focus (M 83) or use focus lock (L 80) to focus on another subject at the same distance and then recompose the photograph.

*There is little or no contrast between the subject and the background*

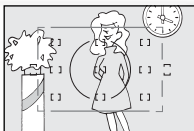

Example: subject is the same color as the background.

*The focus area contains objects at different distances from the camera*

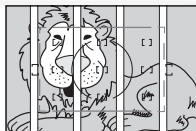

Example: subject is inside a cage.

*The subject is dominated by regular geometric patterns*

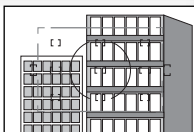

Example: a row of windows in a skyscraper.

*The focus area contains areas of sharply contrasting brightness*



Example: subject is half in the shade.

*The subject appears smaller than the focus area*

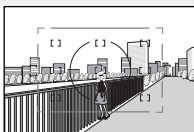

Example: focus area contains both foreground subject and distant buildings.

*The subject many contains fine details*

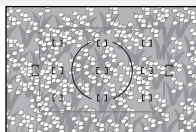

Example: a field of flowers or other subjects that are small or lack variation in brightness.

### AF-Assist Illuminators

If the subject is dark, a Speedlight with an AF-assist illuminator can be used to assist the autofocus.



## Manual Focus

Manual focus is available for lenses that do not support autofocus (non-AF Nikkor lenses) or when the autofocus does not produce the desired results (82). To focus manually, set the focus-mode selector to **M** and adjust the lens focusing ring until the image displayed on the clear matte field in the viewfinder is in focus. Photographs can be taken at any time, even when the image is not in focus.

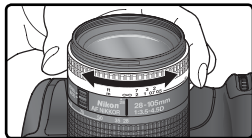
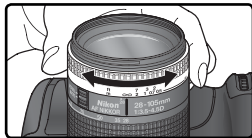
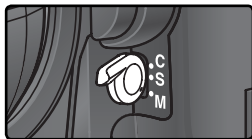

### *The Electronic Range Finder*

If the lens has a maximum aperture of  $f/5.6$  or faster, the viewfinder focus indicator can be used to confirm whether the subject in the selected focus area is in focus. After positioning the subject in the active focus area, press the shutter-release button halfway and rotate the lens focusing ring until the in-focus indicator (●) is displayed.

### **A-M Selection/Autofocus with Manual Priority**

When using a lens that offers A-M selection, select M when focusing manually. With lenses that support M/A (autofocus with manual priority), focus can be adjusted manually with the lens set to M or M/A. See the documentation provided with your lens for details.



### **Focal Plane Position**

To determine the distance between your subject and the camera, measure from the focal plane mark on the camera body. The distance between the lens mounting flange and the focal plane is 46.5mm (1.83").



### Metering

The metering method determines how the camera sets exposure:

Method	Description
 3D color matrix II / Color matrix II / Color matrix	1,005-pixel RGB sensor sets exposure based on variety of information from all areas of frame. With type G or D lens, camera uses <i>3D color matrix metering II</i> for natural results even when frame is dominated by bright (white or yellow) or dark (black or dark green) colors. With other CPU lenses, 3D range information is not included; instead, camera uses <i>color matrix metering II</i> . <i>Color matrix metering</i> is available when focal length and maximum aperture of non-CPU lens are specified using <b>Non-CPU lens data</b> item in shooting menu (📷 128; center-weighted metering is used if focal length or aperture is not specified). Matrix metering will not produce desired results with autoexposure lock (📷 95) or exposure compensation (📷 97), but is recommended in most other situations.
 Center-weighted	Camera meters entire frame but assigns greatest weight to area in center of frame 8mm (0.31") in diameter, shown by corresponding 8-mm reference circle in viewfinder. Classic meter for portraits; recommended when using filters with an exposure factor (filter factor) over 1 × (📷 245).*
 Spot	Camera meters circle 3mm (0.12") in diameter (approximately 2% of frame). Circle is centered on current focus area (in group dynamic AF, on center focus area of current group; 📷 76), making it possible to meter off-center subjects (if non-CPU lens is used or if dynamic-area AF with closest subject priority is in effect, camera will meter center focus area). Ensures that subject will be correctly exposed, even when background is much brighter or darker.*

\* For improved precision with non-CPU lenses, specify lens focal length and maximum aperture in **Non-CPU lens data** menu (📷 128).

Before shooting, press the metering selector lock button and rotate the metering selector to choose a method suited to the composition and lighting conditions, and confirm your selection in the viewfinder.

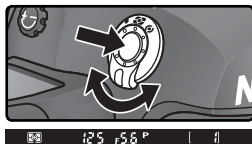

#### **b6—Center Weight (📷 191)**

This option controls the size of the area assigned the greatest weight in center-weighted metering.

## Exposure Mode

Exposure mode determines how the camera sets shutter speed and aperture when adjusting exposure. Four modes are available: programmed auto (**P**), shutter-priority auto (**S**), aperture-priority auto (**A**), and manual (**M**).

### CPU Lenses

When using a CPU lens equipped with an aperture ring, lock the aperture ring at the minimum aperture (highest f-number). At other settings, the shutter release will be disabled and a blinking **fE E** will appear in the aperture displays in the top control panel and viewfinder. Type G lenses are not equipped with an aperture ring.

### Depth-of-Field Preview

To preview the effects of aperture, press and hold the depth-of-field preview button. The lens will be stopped down to the aperture value selected by the camera (modes **P** and **S**) or the value chosen by the user (modes **A** and **M**), allowing depth of field to be previewed in the viewfinder (if an optional SB-800 or SB-600 Speedlight is attached, a modeling flash will be emitted).



### **b1—ISO Auto** 188

When **On** is selected for Custom Setting b1 (**ISO auto**), the camera automatically varies sensitivity in the range 100–800 (ISO equivalent) to help ensure optimum exposure when the limits of the camera exposure metering system are exceeded (exposure modes **P**, **S**, and **A**) or optimum exposure can not be achieved at the shutter-speed and aperture selected by the user (exposure mode **M**). When sensitivity is altered from the value selected by the user, **ISO-AUTO** will flash in the rear control panel and a flashing **ISO-A** will be displayed in the viewfinder. In the camera photo information display for pictures taken at altered sensitivities, the ISO value will also be displayed in red. Note that noise is more likely to appear in photographs taken at higher sensitivities.

**On** can not be selected for **ISO auto** when sensitivity is set to **HI-1** or **HI-2**; similarly, **HI-1** or **HI-2** can not be selected when **ISO auto** is on. If a flash is used when **ISO auto** is on, ISO will be fixed at the value selected by the user. If **ISO auto** is on when autoexposure bracketing is selected in exposure mode **M**, sensitivity will vary around the value selected by the user as required by the bracketing program.

### **b7—Fine-Tune Exposure** 191

Optimal exposure can be fine-tuned separately for each metering method (note that the exposure compensation icon is not displayed when exposure is fine-tuned).

### **e4—Modeling Flash** 199

If **Off** is selected for Custom Setting e4 (**Modeling flash**), the optional SB-800 and SB-600 will not emit a modeling flash when the depth-of-field preview button is pressed.

## P: Programmed Auto

In this mode, the camera automatically adjusts shutter speed and aperture according to a built-in program (see below) for optimal exposure in most situations. This mode is recommended for snapshots and other situations in which you want to leave the camera in charge of shutter speed and aperture. Adjustments can be made using flexible program, exposure compensation (📷 97), and auto exposure bracketing (📷 98). Programmed auto is only available with CPU lenses.

To take photographs in programmed auto:

- 1 Press the **MODE** button and rotate the main command dial until **P** is displayed in the viewfinder and top control panel.

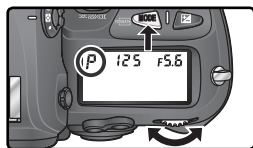

- 2 Frame a photograph, focus, and shoot.

### 🔪 Non-CPU Lenses



Exposure mode **A** (aperture-priority auto) is automatically selected when a non-CPU lens is attached. The exposure mode indicator (**P**) in the top control panel will blink and **A** will be displayed in the viewfinder. For more information, see “Aperture-Priority Auto” (📷 90).

### 🔪 Exposure Warning

If the limits of the exposure metering system are exceeded, one of the following indicators will be displayed in the control panel and viewfinder:

Indicator	Description
Hi	Subject too bright. Use optional Neutral Density (ND) filter or lower sensitivity (ISO equivalency; 📷 52).
Lo	Subject too dark. Use optional Speedlight or raise sensitivity (ISO equivalency; 📷 52).

### Flexible Program

In programmed auto, different combinations of shutter speed and aperture can be selected by rotating the main command dial (“flexible program”). All combinations produce the same exposure. While flexible program is in effect, an asterisk (“\*”) appears next to the exposure-mode indicator in the top control panel. To restore default shutter speed and aperture settings, rotate the main command dial until the indicator is no longer displayed. Default settings can also be restored by turning the camera off, selecting another exposure mode, performing a two-button reset ( 133), or choosing another setting for Custom Setting b3 (**EV step**;  189).

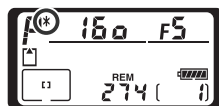

### Exposure Program

The exposure program for programmed auto is shown in the following graph:

ISO 100; lens with maximum aperture of f/1.4 and minimum aperture of f/16 (e.g., AF 50 mm f/1.4 D)

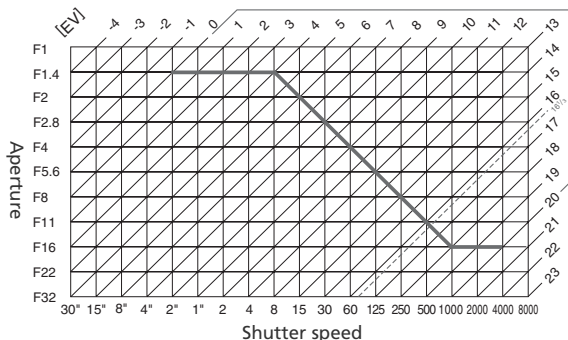

The maximum and minimum values for EV vary with sensitivity (ISO equivalency); the above graph assumes a sensitivity of ISO 100 equivalent. When matrix metering is used, values over 16⅓ EV are reduced to 16⅓ EV.

## S: Shutter-Priority Auto

In shutter-priority auto, you choose the shutter speed while the camera automatically selects the aperture that will produce the optimal exposure. Shutter speed can be set to values between 30s and  $\frac{1}{8,000}$ s. Use slow shutter speeds to suggest motion by blurring moving objects, high shutter speeds to “freeze” motion. Shutter-priority auto is only available with CPU lenses.

To take photographs in shutter-priority auto:

- 1 Press the **MODE** button and rotate the main command dial until **S** is displayed in the viewfinder and top control panel.
- 2 Rotate the main command dial to choose the desired shutter speed.
- 3 Frame a photograph, focus, and shoot.

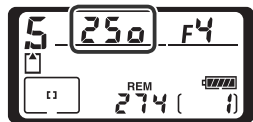

 **Non-CPU Lenses**



Exposure mode **A** (aperture-priority auto) is automatically selected when a non-CPU lens is attached. The exposure mode indicator (**S**) in the top control panel will blink and **A** will be displayed in the viewfinder. For more information, see “Aperture-Priority Auto” (📖 90).

 **Changing from Manual to Shutter-Priority Auto**

If you select a shutter speed of **b u l b** in manual exposure mode and then select shutter-priority auto without changing the shutter speed, the **b u l b** indicator in the shutter-speed display will flash and the shutter can not be released. Rotate the main command dial to select a different shutter speed before shooting.

 **Exposure Warning**

If the camera is unable to produce the correct exposure at the selected shutter speed, the electronic analog exposure display (📖 93) in the viewfinder will show the amount of under- or over-exposure and one of the following indicators will be displayed in the control panel and viewfinder aperture displays:

Indicator	Description
	Subject too bright. Choose faster shutter speed or lower sensitivity (ISO equivalency; 📖 52), or use optional Neutral Density (ND) filter.
	Subject too dark. Choose slower shutter speed or higher sensitivity (ISO equivalency; 📖 52), or use optional Speedlight.

 **Shutter-Speed Lock**

Shutter speed can be locked at the selected setting (📖 94).

 **Long Exp. NR (📖 173)**

To reduce noise at shutter speeds of about 1/2 s or slower, select **On** for the **Long exp. NR** option in the shooting menu. Note that noise and color distortion increase with temperature.

 **b3—EV Step (📖 189)**

This option controls whether changes to shutter speed and aperture are made in increments equivalent to 1/3 EV (the default setting), 1/2 EV, or 1 EV.

 **f5—Command Dials > Change Main/Sub (📖 206)**

This option can be used to reverse the roles of the command dials so that the sub-command dial controls shutter speed, while the main command dial controls aperture.

## A: Aperture-Priority Auto

In aperture-priority auto, you choose the aperture while the camera automatically selects the shutter speed that will produce the optimal exposure. Small apertures (high f/-numbers) increase depth of field, bringing both the main subject and background into focus. Large apertures (low f/-numbers) soften background details and let more light into the camera, increasing the range of the flash and making photographs less susceptible to blurring.

To take photographs in aperture-priority auto:

- 1 Press the **MODE** button and rotate the main command dial until **A** is displayed in the viewfinder and top control panel.
- 2 Rotate the sub-command dial to choose the desired aperture.
- 3 Frame a photograph, focus, and shoot.

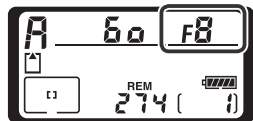



## Non-CPU Lenses

If the maximum aperture of the lens has been specified using the **Non-CPU lens data** item in shooting menu (128) when a non-CPU lens is attached, the current f-number will be displayed in the viewfinder and top control panel, rounded to the nearest full stop. Otherwise the aperture displays will show only the number of stops ( $\Delta F$ , with maximum aperture displayed as  $\Delta F_0$ ) and the f-number must be read from the lens aperture ring.

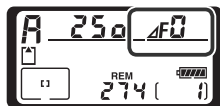

## Exposure Warning

If the camera is unable to produce the correct exposure at the selected aperture, the electronic analog exposure display (93) in the viewfinder will show the amount of under- or over-exposure and one of the following indicators will be displayed in the control panel and viewfinder shutter-speed displays:

Indicator	Description
$\times i$	Subject too bright. Choose smaller aperture (larger f-number) or lower sensitivity (ISO equivalency; 52), or use optional Neutral Density (ND) filter.
$\downarrow a$	Subject too dark. Choose larger aperture (smaller f-number) or higher sensitivity (ISO equivalency; 52), or use optional Speedlight.

## Aperture Lock

Aperture can be locked at the selected setting (94).

## b3—EV Step (189)

This option controls whether changes to shutter speed and aperture are made in increments equivalent to  $\frac{1}{3}$  EV (the default setting),  $\frac{1}{2}$  EV, or 1 EV.

## f5—Command Dials (206)

**Command dials > Change Main/Sub** and **Command dials > Aperture setting** control whether aperture is assigned with the main command dial, the sub-command dial, or the lens aperture ring. Regardless of the settings chosen, the command dials are always used with type G lenses, the lens aperture ring with non-CPU lenses.

## M: Manual

In manual exposure mode, you control both shutter speed and aperture. Shutter speed can be set to values between 30s and  $\frac{1}{8,000}$ s, or the shutter can be held open indefinitely for a long time-exposure (**b u l b**). Aperture can be set to values between the minimum and maximum values for the lens. Using the electronic analog exposure display in the viewfinder, you can adjust exposure according to shooting conditions and the task at hand.

To take photographs in manual exposure mode:

- 1 Press the **MODE** button and rotate the main command dial until **M** is displayed in the viewfinder and top control panel.

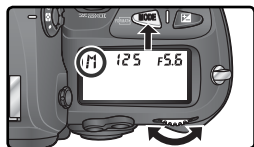

- 2 Rotate the main command dial to choose a shutter speed, and the sub-command dial to set aperture. Check exposure in the electronic analog exposure displays (see right), and continue to adjust shutter speed and aperture until the desired exposure is achieved.

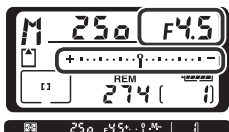
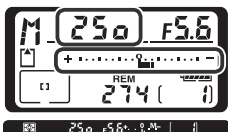

- 3 Frame a photograph, focus, and shoot.

### Long Time-Exposures

At a shutter speed of **b u l b**, the shutter will remain open while the shutter-release button is held down. Nikon recommends using a fully-charged EN-EL4 battery or an optional EH-6 AC adapter to prevent loss of power while the shutter is open. Note that if the shutter is open for more than approximately  $\frac{1}{2}$ s at any setting, "noise" in the form of randomly-spaced, brightly-colored pixels may appear in the final photograph.

### AF Micro Nikkor Lenses

*Provided that an external exposure meter is used*, the exposure ratio need only be taken into account when the lens aperture ring is used to set aperture.

## Non-CPU Lenses

If the maximum aperture of the lens has been specified using the **Non-CPU lens data** item in shooting menu (128) when a non-CPU lens is attached, the current f-number will be displayed in the viewfinder and top control panel, rounded to the nearest full stop. Otherwise the aperture displays will show only the number of stops ( $\Delta F$ , with maximum aperture displayed as  $\Delta F0$ ) and the f-number must be read from the lens aperture ring.

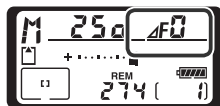

## Electronic Analog Exposure Displays

The electronic analog exposure displays in the top control panel and viewfinder show whether the photograph would be under- or over-exposed at current settings. Depending on the option chosen for Custom Setting b3 (**EV step**), the amount of under- or over-exposure is shown in increments of  $\frac{1}{3}$  EV,  $\frac{1}{2}$  EV, or 1 EV. If the limits of the exposure metering system are exceeded, the displays will flash.

"EV step" set to "1/3 step"		"EV step" set to "1/2 step"		"EV step" set to "1 step"	
Top control panel	Viewfinder	Top control panel	Viewfinder	Top control panel	Viewfinder
Optimal exposure					
Underexposed by $\frac{1}{3}$ EV		Underexposed by $\frac{1}{2}$ EV		Underexposed by 1 EV	
Overexposed by more than 3 EV *					

\* At **1/3 step**,  appears in the viewfinder when overexposure exceeds 2 EV.

## Long Exp. NR (173)

To reduce noise at shutter speeds of about  $\frac{1}{2}$ s or slower, select **On** for the **Long exp. NR** option in the shooting menu. Note that noise and color distortion increase with temperature.

## b3—EV Step (189)

This option controls whether changes to shutter speed and aperture are made in increments equivalent to  $\frac{1}{3}$  EV (the default setting),  $\frac{1}{2}$  EV, or 1 EV.

## f5—Command Dials (206)

**Command dials > Change Main/Sub** and **Command dials > Aperture setting** control whether aperture is assigned with the main command dial, the sub-command dial, or the lens aperture ring. Regardless of the settings chosen, the command dials are always used with type G lenses, the lens aperture ring with non-CPU lenses.

## Shutter-Speed and Aperture Lock

The **L** button can be used to lock shutter speed at the value selected in shutter-priority auto or manual exposure mode, or to lock aperture at the value selected in aperture-priority auto and manual exposure modes. Lock is not available in programmed auto.

### Shutter-Speed Lock

To lock shutter speed at the selected value, press the **L** button and rotate the main command dial until shutter-speed lock icons appear in the viewfinder and the top control panel.



To unlock shutter speed, press the **L** button and rotate the main command dial until the lock icons disappear from the displays.

### Aperture Lock

To lock aperture at the selected value, press the **L** button and rotate the sub-command dial until aperture lock icons appear in the viewfinder and the top control panel.

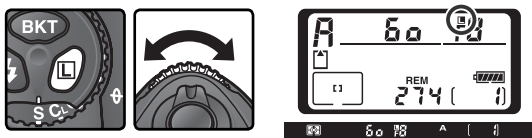

To unlock aperture, press the **L** button and rotate the sub-command dial until the lock icons disappear from the displays.

## Autoexposure Lock

When center-weighted metering is used, an area in the center of the frame is assigned the greatest weight when determining exposure. Similarly, when spot metering is used, exposure is based upon lighting conditions in the selected focus area. If the subject is not in the metered area when the picture is taken, exposure will be based on lighting conditions in the background, and the main subject may be under- or over-exposed. To prevent this, use autoexposure lock:

- 1 Select center-weighted or spot metering. If using center-weighted metering, select the center focus area with the multi selector (74).



- 2 Position the subject in the selected focus area and press the shutter-release button halfway. With the shutter-release button pressed halfway and the subject positioned in the focus area, press the **AE-L/AF-L** button to lock exposure (and focus, except in manual focus mode). Confirm that the in-focus indicator (●) appears in the viewfinder.

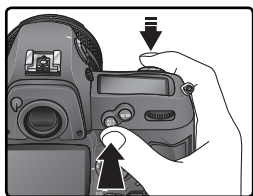
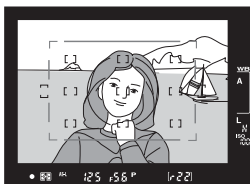

While exposure lock is in effect, an **AE-L** indicator will appear in the viewfinder.

**3** Keeping the **AE-L/AF-L** button pressed, recompose the photograph and shoot.

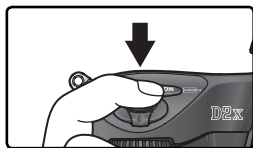
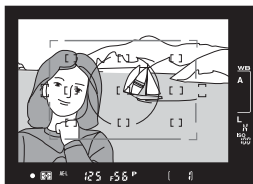

### Metered Area

In spot metering, exposure will be locked at the value metered in a 3-mm (0.12") circle centered on the selected focus area. In center-weighted metering, exposure will be locked at the value metered in an 8-mm (0.31") circle at the center of the viewfinder.

### Adjusting Shutter Speed and Aperture

While exposure lock is in effect, the following settings can be changed without altering the metered value for exposure:

Exposure mode	Settings
Programmed auto	Shutter speed and aperture (flexible program;  87)
Shutter-priority auto	Shutter speed
Aperture-priority auto	Aperture

The new values can be confirmed in the viewfinder and control panel. Note that the metering method can not be changed while exposure lock is in effect (changes to metering take effect when the lock is released).

### c1—AE Lock ( 192)



If **+Release Button** is selected for **AE lock**, exposure will lock when the shutter-release button is pressed halfway.



### c2—AE-L/AF-L ( 192)

Depending on the option selected, the **AE-L/AF-L** button locks both focus and exposure (the default setting), only focus, or only exposure. Options are available for keeping exposure locked until the **AE-L/AF-L** button is pressed a second time, the shutter is released, or exposure meters turn off.

## Exposure Compensation

To obtain the desired results with certain subject compositions, it may be necessary to use exposure compensation to alter exposure from the value suggested by the camera. As a rule of thumb, positive compensation may be needed when the main subject is darker than the background, negative values when the main subject is brighter than the background.

- 1 Pressing the  button, rotate the main command dial and confirm exposure compensation in the top control panel or the viewfinder (in the viewfinder, positive values are shown by a  icon, negative values by a  icon). Exposure compensation can be set to values between  $-5$  EV (underexposure) and  $+5$  EV (overexposure) in increments of  $\frac{1}{3}$  EV.

At values other than  $\pm 0$ , the 0 at the center of the electronic analog exposure displays will flash and a  icon will be displayed in the control panel and viewfinder after you release the  button. The current value for exposure compensation can be confirmed in the electronic analog exposure display or by pressing the  button.

- 2 Frame the photograph, focus, and shoot.

Normal exposure can be restored by setting exposure compensation to  $\pm 0$  or performing a two button reset ( 133). Exposure compensation is not reset when the camera is turned off.

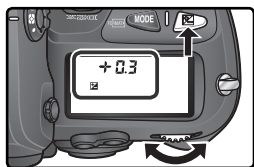

 12.5 f/5.6  0.0  
 $\pm 0$  EV ( button pressed)

 16.0 f/5.6  0.3  
 $-0.3$  EV

 6.0 f/4  2.0  
 $+2.0$  EV

### b4—Exposure Comp. EV ( 189)



Use this option to set the increments for exposure compensation to  $\frac{1}{2}$  or 1 EV.

### b5—Exposure Comp. ( 190)

If desired, exposure compensation can be set without pressing the  button.

## Bracketing



The D2X offers three types of bracketing: exposure bracketing, flash bracketing, and white balance bracketing. In exposure bracketing, the camera varies exposure compensation with each shot, while in the case of flash bracketing, flash level is varied with each shot (i-TTL and auto aperture flash control modes only;  107, 109). Only one photograph is produced each time the shutter is released, meaning that several shots (up to nine) are required to complete the bracketing sequence. Exposure and flash bracketing are recommended in situations in which it is difficult to set exposure and there is not enough time to check results and adjust settings with each shot.

In white balance bracketing, the camera creates multiple images each time the shutter is released, each with a different white balance adjustment ( 103). Only one shot is required to complete the bracketing sequence. White balance bracketing is recommended when shooting under mixed lighting or experimenting with different white balance settings. White balance bracketing is not available at white-balance settings of  (**Choose color temp.**) or **PRE** (preset) or at image qualities of **NEF (Raw)**, **NEF+JPEG Fine**, **NEF+JPEG Normal**, or **NEF+JPEG Basic**.

### Exposure and Flash Bracketing

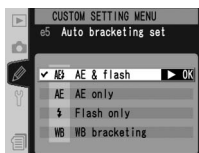
**1** Select the type of bracketing to be performed using Custom Setting e5 (**Auto BKT set**;  200). Choose **AE & flash** to vary both exposure and flash level (the default setting), **AE only** to vary only exposure, or **Flash only** to vary only flash level.



**2** Pressing the  button, rotate the main command dial to choose the number of shots in the bracketing sequence ( 100–102). At settings other than zero, a **BKT** icon and bracketing indicator will be displayed in the top control panel, and a **BKT** icon will appear in the viewfinder.





- 3 Pressing the **BKT** button, rotate the sub-command dial to choose the exposure increment (100–102).



- 4 Compose a photograph, focus, and shoot. The camera will vary exposure and/or flash level shot-by-shot according to the bracketing program selected. Modifications to exposure are added to those made with exposure compensation (97), making it possible to achieve exposure compensation values of more than 5EV.

While bracketing is in effect, a bracketing progress indicator will be displayed in the top control panel. A segment will disappear from the indicator after each shot.

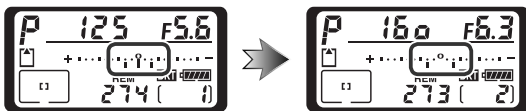

To cancel bracketing, press the **BKT** button and rotate the main command dial until the number of shots in the bracketing sequence is zero and **BKT** is no longer displayed in the control panel on top of the camera. The program last in effect will be restored the next time bracketing is activated. Bracketing can also be cancelled by performing a two-button reset (133), although in this case the bracketing program will not be restored the next time bracketing is activated. Selecting **WB bracketing** for Custom Setting e5 cancels the current the bracketing program.

### Shooting Mode



















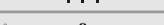
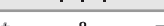
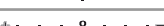
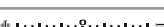

In single frame and self-timer modes, one shot will be taken each time the shutter-release button is pressed. In continuous low speed and continuous high speed modes, shooting will pause after the number of shots specified in the bracketing program have been taken. Shooting will resume the next time the shutter-release button is pressed.

### e8—Auto BKT Selection (202)

If desired, the main command dial can be used to turn bracketing on and off and the sub-command dial to select both the number of shots and the exposure increment.

The bracketing programs available depend on the option selected for Custom Setting b3 (**EV step**;  189).

### 1/3 Step Selected for EV Step

Control panel display	No. of shots	Exposure increment	Bracketing order (EVs)
+3F 0.3 	3	+1/3 EV	+0.3, 0, +0.7
+3F 0.7 	3	+2/3 EV	+0.7, 0, +1.3
+3F 1.0 	3	+1 EV	+1.0, 0, +2.0
--3F 0.3 	3	-1/3 EV	-0.3, -0.7, 0
--3F 0.7 	3	-2/3 EV	-0.7, -1.3, 0
--3F 1.0 	3	-1 EV	-1.0, -2.0, 0
+2F 0.3 	2	+1/3 EV	0, +0.3
+2F 0.7 	2	+2/3 EV	0, +0.7
+2F 1.0 	2	+1 EV	0, +1.0
--2F 0.3 	2	-1/3 EV	0, -0.3
--2F 0.7 	2	-2/3 EV	0, -0.7
--2F 1.0 	2	-1 EV	0, -1.0
3F 0.3 	3	±1/3 EV	0, -0.3, +0.3
3F 0.7 	3	±2/3 EV	0, -0.7, +0.7
3F 1.0 	3	±1 EV	0, -1.0, +1.0
5F 0.3 	5	±1/3 EV	0, -0.7, -0.3, +0.3, +0.7
5F 0.7 	5	±2/3 EV	0, -1.3, -0.7, +0.7, +1.3
5F 1.0 	5	±1 EV	0, -2.0, -1.0, +1.0, +2.0
7F 0.3 	7	±1/3 EV	0, -1.0, -0.7, -0.3, +0.3, +0.7, +1.0
7F 0.7 	7	±2/3 EV	0, -2.0, -1.3, -0.7, +0.7, +1.3, +2.0
7F 1.0 	7	±1 EV	0, -3.0, -2.0, -1.0, +1.0, +2.0, +3.0
9F 0.3 	9	±1/3 EV	0, -1.3, -1.0, -0.7, -0.3, +0.3, +0.7, +1.0, +1.3
9F 0.7 	9	±2/3 EV	0, -2.7, -2.0, -1.3, -0.7, +0.7, +1.3, +2.0, +2.7
9F 1.0 	9	±1 EV	0, -4.0, -3.0, -2.0, -1.0, +1.0, +2.0, +3.0, +4.0



## 1/2 Step Selected for EV Step

Control panel display	No. of shots	Exposure increment	Bracketing order (EVs)
+ 3F 0.5	3	+½ EV	+0.5, 0, +1.0
+ 3F 1.0	3	+1 EV	+1.0, 0, +2.0
-- 3F 0.5	3	-½ EV	-0.5, -1.0, 0
-- 3F 1.0	3	-1 EV	-1.0, -2.0, 0
+ 2F 0.5	2	+½ EV	0, +0.5
+ 2F 1.0	2	+1 EV	0, +1.0
-- 2F 0.5	2	-½ EV	0, -0.5
-- 2F 1.0	2	-1 EV	0, -1.0
3F 0.5	3	±½ EV	0, -0.5, +0.5
3F 1.0	3	±1 EV	0, -1.0, +1.0
5F 0.5	5	±½ EV	0, -1.0, -0.5, +0.5, +1.0
5F 1.0	5	±1 EV	0, -2.0, -1.0, +1.0, +2.0
7F 0.5	7	±½ EV	0, -1.5, -1.0, -0.5, +0.5, +1.0, +1.5
7F 1.0	7	±1 EV	0, -3.0, -2.0, -1.0, +1.0, +2.0, +3.0
9F 0.5	9	±½ EV	0, -2.0, -1.5, -1.0, -0.5, +0.5, +1.0, +1.5, +2.0
9F 1.0	9	±1 EV	0, -4.0, -3.0, -2.0, -1.0, +1.0, +2.0, +3.0, +4.0

## 1 Step Selected for EV Step

Control panel display	No. of shots	Exposure increment	Bracketing order (EVs)
+3F 1.0	3	+1 EV	+1.0, 0, +2.0
--3F 1.0	3	-1 EV	-1.0, -2.0, 0
+2F 1.0	2	+1 EV	0, +1.0
--2F 1.0	2	-1 EV	0, -1.0
3F 1.0	3	±1 EV	0, -1.0, +1.0
5F 1.0	5	±1 EV	0, -2.0, -1.0, +1.0, +2.0
7F 1.0	7	±1 EV	0, -3.0, -2.0, -1.0, +1.0, +2.0, +3.0
9F 1.0	9	±1 EV	0, -4.0, -3.0, -2.0, -1.0, +1.0, +2.0, +3.0, +4.0

### Resuming Exposure or Flash Bracketing

If the memory card fills before all shots in the sequence when shooting auto, the camera can be resumed from the next shot in the sequence after the memory card has been replaced or shots have been deleted to make room on the memory card. If the camera is turned off before all shots in the sequence have been taken, bracketing will resume from the next shot in the sequence when the camera is turned on.

### Exposure Bracketing

The camera modifies exposure by varying shutter speed and aperture (programmed auto), aperture (shutter-priority auto), or shutter speed (aperture-priority auto, manual exposure mode). When **On** is selected for Custom Setting b1 (**ISO auto**) and no Speedlight is attached, the camera will automatically vary sensitivity for optimum exposure when the limits of the camera exposure system are exceeded in programmed auto, shutter-priority auto, or aperture-priority exposure mode. If Custom Setting e5 (**Auto BKT set**) is set **AE only** or to **AE & Flash** with no Speedlight attached and **On** is selected for Custom Setting b1 (**ISO auto**), the camera will vary sensitivity without varying shutter speed or aperture, regardless of the setting chosen for Custom Setting e6 (see below).

### e6—Manual Mode Bkting 201

This option controls how the camera performs exposure and flash bracketing in manual exposure mode. Bracketing can be performed by varying flash level together with shutter speed and/or aperture, or by varying flash level alone.

### e7—Auto BKT Order 201

This option can be used to change the bracketing order.

## White Balance Bracketing

- 1 Choose **WB bracketing** for Custom Setting e5 (**Auto BKT set**; 200).

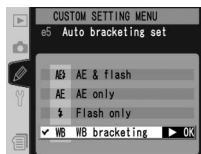

- 2 Pressing the **BKT** button, rotate the main command dial to choose the number of shots in the bracketing sequence ( 105). At settings other than zero, a **WB-BKT** icon and bracketing indicator will appear in the top control panel. The rear control panel will show **WB-BKT** and the viewfinder **BKT**.

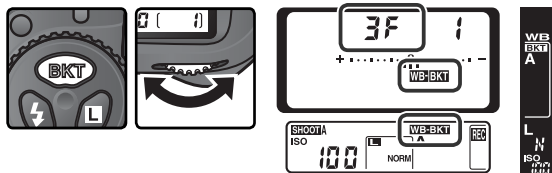

If the number of shots in the bracketing program is greater than the number of exposures remaining, a flashing icon will appear in the top control panel and the frame count and number of exposures remaining will flash. A flashing indicator will appear in the viewfinder and the shutter release will be disabled. Shooting can begin when a new memory card is inserted.

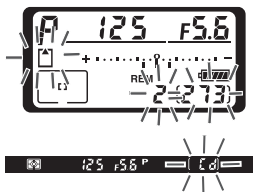

- 3 Pressing the **BKT** button, rotate the sub-command dial to choose the white balance adjustment ( 105). Each increment is roughly equivalent to 10 mired.



**4** Compose a photograph, focus, and shoot. Each shot will be processed to create the number of copies specified in the bracketing program, and each copy will have a different white balance. Modifications to white balance are added to the white balance adjustment made with white balance fine-tuning (🔍 56).

To cancel bracketing, press the **BKT** button and rotate the main command dial until the number of shots in the bracketing sequence is zero and white-balance bracketing indicators are no longer displayed in the control panels and viewfinder. The program last in effect will be restored the next time bracketing is activated. Bracketing can also be cancelled by performing a two-button reset (🔍 133), although in this case the bracketing program will not be restored the next time bracketing is activated.

### 🔍 White Balance Bracketing

White balance bracketing is not available at white-balance settings of **K** (Choose color temp.) or **PRE** (preset) or at an image quality of NEF (RAW). Selecting **NEF (Raw)**, **NEF+JPEG Fine**, **NEF+JPEG Normal**, or **NEF+JPEG Basic** cancels white balance bracketing.

### 🔍 Shooting Mode

In single frame and self-timer modes, the number of copies specified in the white balance program will be created each time the shutter is released. In continuous low speed and continuous high speed modes, only one shot will be taken each time the shutter-release button is pressed. Each shot will be processed to create the number of copies specified in the bracketing program.

### 🔍 Turning the Camera Off

If the camera is turned off while the camera while the memory card access lamp is lit, the camera will power off only after all photographs in the sequence have been recorded. To turn the camera off without recording the remaining photographs, press the **🔍** button while turning the camera off (keep the **🔍** button pressed for at least one second after turning the camera off).

### 🔍 e8—Auto BKT Selection (🔍 202)

If desired, the main command dial can be used to turn bracketing on and off and the sub-command dial to select both the number of shots and the white-balance increment.





The number of shots, white balance (WB) increment, and bracketing order for each of the possible white-balance bracketing programs is shown below.

Control panel display	No. of shots	WB increment	Bracketing order
+3F 1	3	+1	+1, 0, +2
+3F 2	3	+2	+2, 0, +4
+3F 3	3	+3	+3, 0, +6
--3F 1	3	-1	-1, -2, 0
--3F 2	3	-2	-2, -4, 0
--3F 3	3	-3	-3, -6, 0
+2F 1	2	+1	0, +1
+2F 2	2	+2	0, +2
+2F 3	2	+3	0, +3
--2F 1	2	-1	0, -1
--2F 2	2	-2	0, -2
--2F 3	2	-3	0, -3
3F 1	3	±1	0, -1, +1
3F 2	3	±2	0, -2, +2
3F 3	3	±3	0, -3, +3
5F 1	5	±1	0, -2, -1, +1, +2
5F 2	5	±2	0, -4, -2, +2, +4
5F 3	5	±3	0, -6, -3, +3, +6
7F 1	7	±1	0, -3, -2, -1, +1, +2, +3
7F 2	7	±2	0, -6, -4, -2, +2, +4, +6
7F 3	7	±3	0, -9, -6, -3, +3, +6, +9
9F 1	9	±1	0, -4, -3, -2, -1, +1, +2, +3, +4
9F 2	9	±2	0, -8, -6, -4, -2, +2, +4, +6, +8
9F 3	9	±3	0, -12, -9, -6, -3, +3, +6, +9, +12

#### e7—Auto BKT Order 201

This option can be used to change the bracketing order.

The D2X supports flash photography when an optional Speedlight is mounted on the camera's accessory shoe. A flash can be used not only when natural lighting is inadequate, but also to fill in shadows, illuminate back-lit subjects, and even to add a catch light to the eyes of a portrait subject.

When used with an SB-800 or SB-600 Speedlight (available separately;  245), the D2X supports the full range of options available with the Nikon Creative Lighting System (CLS), including Advanced Wireless Lighting, i-TTL flash control ( 107), FV Lock ( 114), Flash Color Information Communication ( 54), and Auto FP High-Speed Sync. See the Speedlight manual for details.

### Modeling Illumination

SB-800 and SB-600 Speedlights emit a modeling flash when the camera depth-of-field preview button is pressed. This feature can be used with Advanced Wireless Lighting to preview the total lighting effect achieved with multiple flash units. Modeling illumination can be turned off using Custom Setting e4 (**Modeling flash**;  199).



## TTL Flash Control

TTL flash control is available only with optional SB-series 800, 600, 80DX, 28DX, and 50DX Speedlights.

### **SB-800, SB-600: i-TTL Flash Control**

When the SB-800 or SB-600 is set to TTL, the camera automatically selects one of the following types of flash control:

**i-TTL Balanced Fill-Flash for Digital SLR:** Speedlight emits series of nearly invisible preflashes (monitor preflashes) immediately before main flash. Preflashes reflected from objects in all areas of frame are picked up by five-segment TTL flash control sensor or 1,005-pixel RGB sensor and are analyzed in combination with information from matrix metering system to adjust flash output for natural balance between main subject and ambient background lighting. If type G or D lens is used, distance information is included when calculating flash output. Precision of calculation can be increased for non-CPU lenses by providing lens data (focal length and maximum aperture;  128–131). Not available when spot metering is used.

**Standard i-TTL Flash for Digital SLR:** Flash output adjusted to bring lighting in frame to standard level; brightness of background is not taken into account. Recommended for shots in which main subject is emphasized at expense of background details, or when exposure compensation is used. Standard i-TTL flash for digital SLR is activated automatically when spot metering is selected.



**SB-80DX, SB-28DX, SB-50DX: D-TTL Flash Control**

The type of flash control used with the SB-80DX, SB-28DX, and SB-50DX depends on the lens attached:

Lens	Description
Type G or D lens	<b>3D Multi-Sensor Balanced Fill-Flash for Digital SLR:</b> Speedlight emits series of nearly invisible preflashes (monitor preflashes) immediately before main flash. Preflashes reflected from objects in all areas of frame are picked up by five-segment TTL flash control sensor and analyzed in combination with range information from lens to adjust flash output for natural balance between main subject and ambient background lighting. Not available when spot metering is used.
Other lenses	<b>Multi-Sensor Balanced Fill-Flash for Digital SLR:</b> As above, except that range information is not included in regulating flash output. Precision of calculation can be increased for non-CPU lenses by providing lens data (focal length and maximum aperture;  128–131). Not available when spot metering is used.
All types	<b>Standard TTL Flash for Digital SLR:</b> Flash output adjusted to bring lighting in frame to standard level; brightness of background is not taken into account. Recommended for shots in which main subject is emphasized at expense of background details, or when exposure compensation is used. Standard TTL flash for digital SLR is activated automatically when spot metering is selected.

## Compatible Speedlights

The following Speedlights support TTL flash control:

Speedlight Flash mode/feature		SB-800	SB-600	Advanced Wireless Lighting		SB-80DX	SB-50DX
				SB-800	SB-600 <sup>1</sup>	SB-28DX	
TTL	i-TTL <sup>2</sup>	✓	✓	✓	—	—	—
	D-TTL <sup>3</sup>	—	—	—	—	✓	✓
AA	Auto aperture <sup>4</sup>	✓ <sup>5</sup>	—	✓	—	✓ <sup>6</sup>	—
A	Non-TTL auto	✓ <sup>5</sup>	—	✓ <sup>7</sup>	—	✓ <sup>8</sup>	—
GN	Range-priority manual	✓	—	—	—	—	—
M	Manual	✓	✓	✓	✓	✓	✓
	FP high-speed sync	—	—	—	—	✓ <sup>9</sup>	—
	Repeating flash	✓	—	✓	✓	✓	—
REAR	Rear-curtain sync	✓	✓	✓	✓	✓	✓
	Red-eye reduction	✓	✓	✓	✓	✓	—
Flash Color Information Communication		✓	✓	✓ <sup>10</sup>	—	—	—
Auto FP High-Speed Sync <sup>11</sup>		✓	✓	✓	✓	—	—
FV Lock		✓	✓	✓	✓	—	—
AF-assist for multi-area AF <sup>12</sup>		✓	✓	✓	✓	—	—

1 Functions as remote flash only.

2 Standard i-TTL for Digital SLR is used with spot metering or when selected with Speedlight. When using non-CPU lens with i-TTL Balanced Fill-Flash for Digital SLR, improved precision can be obtained if lens data are specified in **Non-CPU lens data** menu.

3 Standard TTL Flash for Digital SLR is used with spot metering. In other metering modes, flash control depends on lens type:

- **Type G or D Nikkor** (excluding IX Nikkor): 3D Multi Sensor Balanced Fill-Flash for Digital SLR
- **Other Nikkor** (excluding AF Nikkor lenses for F3AF): Multi Sensor Balanced Fill-Flash for Digital SLR (when using non-CPU lens, specify lens data in **Non-CPU lens data** menu for improved precision)

4 Not available with non-CPU lenses unless lens data have been specified using **Non-CPU lens data**.

5 Use Speedlight controls to select flash mode.

6 Select **On** for Custom Setting e3 (**AA flash mode**;  199).

7 Available only if non-CPU lens is used without specifying lens data in **Non-CPU lens data** menu.

8 Select **Off** for Custom Setting e3 (**AA flash mode**;  199).



9 Set Speedlight to mode M and select FP high-speed sync manually.

10 Only available when SB-800 is used as master flash.

11 Select **1/250 (Auto FP)** for Custom Setting e1 (**Flash sync speed**;  198).

12 Available with AF CPU lenses only.

The following Speedlights can be used in non-TTL auto and manual modes. If they are set to TTL, the camera shutter-release button will lock and no photographs can be taken.

Speedlight		SB-28		SB-27 <sup>2</sup>		SB-25		SB-24		SB-23 SB-29 <sup>3</sup> SB-21B <sup>3</sup> SB-29S <sup>3</sup>		SB-30 SB-22S SB-22 SB-20 SB-16B		SB-11 <sup>4</sup> SB-14 <sup>4</sup>	
		SB-26 <sup>1</sup>													
Flash mode															
A	Non-TTL auto	✓	✓	✓	✓	✓	✓	✓	✓	—	✓	✓	✓	✓	✓
M	Manual	✓	✓	✓	✓	✓	✓	✓	✓	✓	✓	✓	✓	✓	✓
	FP high-speed sync	✓ <sup>5</sup>	—	✓ <sup>5</sup>	—	—	—	—	—	—	—	—	—	—	—
	Repeating flash	✓	—	✓	✓	✓	✓	✓	✓	—	—	—	—	—	—
REAR	Rear-curtain sync	✓	✓	✓	✓	✓	✓	✓	✓	✓	✓	✓	✓	✓	✓
	Red-eye reduction	✓	✓	✓	✓	✓	—	—	—	—	—	—	—	—	—

1 The SB-26 can be set to remote mode for wireless remote flash photography. When the wireless remote selector is set to D, shutter speed will be set to under  $\frac{1}{200}$ s.

2 When an SB-27 is mounted on the D2X, the flash mode is automatically set to TTL, and the shutter-release will be disabled. Set the SB-27 to A (non-TTL auto flash).

3 Autofocus is only available with AF-Micro lenses (60 mm, 105 mm, 200 mm, or 70–180 mm).

4 When using the SB-11 or SB-14 in A or M mode, use the SU-2 with an SC-13 sync cable. Although SC-11 and SC-15 sync cables can be used, the flash-ready indicator will not appear in the viewfinder and shutter speed will not be adjusted automatically.

5 Set Speedlight to mode M and select FP high-speed sync manually.

### ✓ Use Only Nikon Flash Accessories

Use only Nikon Speedlights. Negative voltages or voltages over 250V applied to the accessory shoe could not only prevent normal operation, but damage the sync circuitry of the camera or flash. Before using a Nikon Speedlight not included in the list on these pages, contact a Nikon-authorized service representative for more information.

### ISO Auto

If a Speedlight is used when Custom Setting b1 (**ISO auto**) is on, sensitivity (ISO equivalency) will be fixed at the value selected by the user.

## Notes on Optional Speedlights

Refer to the Speedlight manual for detailed instructions. If the Speedlight supports i-TTL or D-TTL flash control, refer to the entry for cameras that support the Creative Lighting System (CLS) or for digital SLR cameras in the table of camera types.

If Auto FP High-Speed Sync is not used, the shutter will synchronize with an external flash at speeds of  $\frac{1}{250}$ s or slower.

If the flash-ready indicator blinks for about three seconds after a photograph is taken with i-TTL or D-TTL flash control, the flash has fired at full power and the photograph may be underexposed.

The SB-28DX displays exposure in increments of  $\frac{1}{3}$  EV. If the camera is set to control exposure in increments of  $\frac{1}{2}$  EV using Custom Setting b2, the SB-28DX exposure display will not show the correct ISO value. The actual exposure value is not affected.

i-TTL and D-TTL flash control can be used to adjust flash output at sensitivity (ISO equivalency) settings between 100 and 800. At settings of HI-1 and HI-2, the desired results may not be achieved at some ranges or aperture settings.

The AF-assist illuminator on SB-series 80DX, 28DX, 28, 27, 26, and 24 Speedlights will only light if all of the following conditions are met: focus mode is set to single-servo auto, an AF-Nikkor lens is used, the subject is poorly lit, and the center focus area is selected or dynamic-area AF is used in combination with closest-subject priority.

In programmed auto, the maximum aperture (minimum f-number) is limited according to sensitivity (ISO equivalency), as shown below:

Maximum aperture at ISO equivalent of:									
100	125	160	200	250	320	400	500	640	800
4	4.2	4.5	4.8	5	5.3	5.6	6	6.3	6.7

For each one-step increase in sensitivity (e.g., from 200 to 400), aperture is stopped down by half an f-stop. If the maximum aperture of the lens is smaller than given above, the maximum value for aperture will be the maximum aperture of the lens.







When an SC-series 17, 28, or 29 sync cable is used for off-camera flash photography, correct exposure may not be achieved in i-TTL or D-TTL mode. We recommend that you choose spot metering to select standard i-TTL or D-TTL flash control. Take a test shot and view the results in the monitor.

In i-TTL or D-TTL mode, use the flash panel or bounce adapter provided with your Speedlight. Do not use other panels such as diffusion panels, as this may produce incorrect exposure.

D-TTL flash control can not be used for multi-flash photography.

## Flash Sync Modes

The D2X supports the following flash sync modes:

Flash sync mode	Description
 Front-curtain sync	This mode is recommended for most situations. In programmed auto and aperture-priority auto modes, shutter speed will automatically be set to values between $\frac{1}{60}$ and $\frac{1}{250}$ s ( $\frac{1}{60}$ to $\frac{1}{8,000}$ s with Auto FP High-Speed Sync).
 Slow sync	Flash is combined with speeds as slow as 30s to capture both subject and background at night or under dim light. This mode is only available in programmed auto and aperture-priority auto exposure modes. Use of tripod is recommended to prevent blurring caused by camera shake.
 Rear-curtain sync	In shutter-priority auto or manual exposure mode, flash fires just before the shutter closes, creating effect of a stream of light behind moving objects. In programmed auto and aperture-priority auto, slow rear-curtain sync is used to capture both subject and background. Use of tripod is recommended to prevent blurring caused by camera shake.
 Slow rear-curtain sync	
 Red-eye reduction	In this mode (available only with SB-series 800, 600, 80DX, 28DX, 28, 27, 26, and 25 Speedlights), red-eye reduction pre-flash lights for approximately one second before main flash. Pupils in subject's eyes to contract, reducing "red-eye" effect sometimes caused by flash.
 Red-eye reduction with slow sync	Combines red-eye reduction with slow sync. This mode is only available with SB-series 800, 600, 80DX, 28DX, 28, 27, 26, and 25 Speedlights in programmed auto and aperture-priority auto exposure modes. Use of a tripod is recommended to prevent blurring caused by camera shake.

### SB-Series 26, 25, and 24 Speedlights





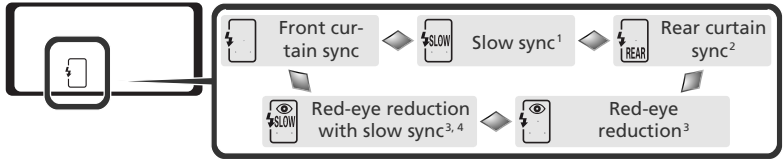

Front- and rear-curtain sync modes for SB-series 26, 25, and 24 Speedlights are set using the sync mode selector on the optional Speedlight. Camera red-eye reduction settings take priority over mode selected with SB-26 and SB-25.

### Studio Flash Systems

Rear-curtain sync can not be used with studio flash systems, as the correct synchronization can not be obtained.

To choose the flash sync mode, press the  button and rotate the main command dial until the desired flash sync mode is selected in the top control panel:



- 1 Available only in exposure modes **P** and **A**. In modes **S** and **M**,  (front-curtain sync) is selected when  button is released.
- 2 In exposure modes **P** and **A**, flash-sync mode will be set to  (slow rear-curtain sync) when the  button is released.
- 3  icon blinks if Speedlight does not support red-eye reduction.
- 4 Red-eye reduction with slow sync is available only in exposure modes **P** and **A**. In modes **S** and **M**,  (red-eye reduction) is selected when the  button is released.

### Shutter Speed and Aperture

Shutter speed and aperture can be set as follows when a Speedlight is used:

Exposure mode	Shutter speed	Aperture	
Programmed auto	Set automatically by camera <sup>1, 2</sup>	Set automatically by camera	86
Shutter-priority auto	1/250 s–30 s <sup>2</sup>		88
Aperture-priority auto	Set automatically by camera <sup>1, 2</sup>	Value selected by user <sup>3</sup>	90
Manual	1/250 s–30 s <sup>2</sup>		92

- 1 Set automatically in the range 1/250 s–1/60 s, or 1/250 s–30 s at flash sync settings of slow sync, slow rear-curtain sync, and red-eye reduction with slow sync.
- 2 If **1/250 (Auto FP)** is selected for Custom Setting e1 (**Flash sync speed**) when an optional SB-800 or SB-600 Speedlight is used, shutter speeds may be as fast as 1/8,000 s.
- 3 Flash range varies with aperture. When setting aperture in exposure modes **A** and **M**, consult the table of flash ranges provided with optional Speedlight.

#### e1—Flash Sync Speed ( 198)

This option can be used to enable Auto FP High-Speed Sync or limit the fastest sync speed to a speed slower than 1/250 s. To fix shutter speed at the sync speed limit in exposure modes **S** and **M**, select the setting after the slowest possible shutter speed (30 s or **b** **w** **l** **b**). An X will be displayed in the flash sync indicator in the top control panel.

#### e2—Flash Shutter Speed ( 198)

This option can be used to limit the slowest shutter speed possible when using an optional Speedlight in programmed auto and aperture-priority auto exposure modes.

## FV Lock

This feature is used to lock flash output, allowing photographs to be re-composed without changing the flash level and ensuring that flash output is appropriate to the subject even when the subject is not positioned in the center of the frame. Flash output is adjusted automatically for any changes in sensitivity (ISO equivalency), aperture, and Speedlight zoom head position. FV lock is available with SB-800 and SB-600 Speedlights only.

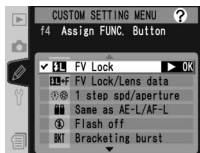

To use FV lock:

- 1 Select **FV Lock** or **FV Lock/Lens data** for Custom Setting f4 (**FUNC. button**;  205).

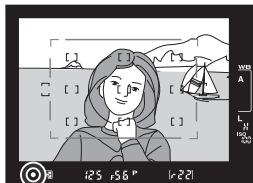

- 2 Mount an SB-800 or SB-600 Speedlight on the camera accessory shoe.
- 3 Turn the Speedlight on and set the flash mode to TTL or AA (see the Speedlight instruction manual for details).
- 4 Position the subject in the center of the frame and press the shutter-release button halfway to focus.



- 5 Press the camera **FUNC.** button. The Speedlight will emit a monitor preflash to determine the appropriate flash level. Flash output will be locked at this level and FV lock icons ( **LOCK** and  **L**) will appear in the control panel and viewfinder.

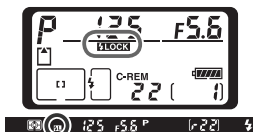



6 Recompose the photograph and press the shutter-release button the rest of the way down to shoot. If desired, additional pictures can be taken without releasing FV lock.

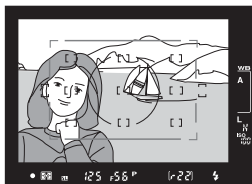

7 Press the camera FUNC. button to release FV lock and confirm that the FV lock icons (⚡LOCK and ⚡L) are no longer displayed in the control panel and viewfinder.

### Metering

The metering areas for FV lock are as follows:

Speedlight	Flash mode	Metered area
Stand-alone flash unit	TTL	5-mm circle in center of frame
	AA	Area metered by Speedlight exposure meter
Used with other flash units (Advanced Wireless Lighting)	TTL	Entire frame
	AA	Area metered by Speedlight exposure meter
	AA (master flash)	

## Flash Contacts and Indicators

The D2X is equipped with an accessory shoe for attaching Speedlights directly to the camera and a sync terminal that allows Speedlights to be connected via a sync cable. When a Speedlight is connected, the flash-ready indicator in the viewfinder shows whether the flash is fully charged and ready for use.

### *The Accessory Shoe*

SB-series Speedlights, including the SB-800, 600, 80DX, 28DX, 50DX, 27, 23, 22s, and 29s, can be mounted directly on the camera accessory shoe without a sync cable. The accessory shoe is equipped with a safety lock for Speedlights with a locking pin (e.g., SB-series 80DX and 27).



### *The Sync Terminal*

A sync cable can be connected to the sync terminal as required. Do not connect another Speedlight via a sync cable when performing rear-curtain sync flash photography with an SB-series Speedlights such as the 800, 600, 80DX, 28DX, 50DX, 27, 23, 22s, or 29s mounted on the camera accessory shoe.

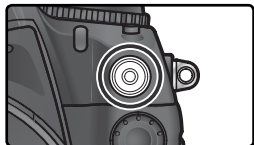

### *The Flash-Ready Indicator*

When an SB-series Speedlight such as the 800, 600, 80DX, 28DX, 50DX, 27, 23, 22s, or 29s is connected, the flash-ready indicator will light when the flash is fully charged and ready for use. If the indicator blinks for approximately three seconds after a photograph is taken in i-TTL or D-TTL modes, the flash has fired at full output and the photograph may be underexposed. Check the results in the monitor. If the photograph is underexposed, adjust the distance to the subject, aperture, or flash range and try again.



# Overlay/Multiple Exposure

*Combining Multiple Exposures in a Single Frame*

The following options are available for combining multiple exposures in a single frame:

- **Image overlay:** two existing RAW photographs are combined to form a single picture which is saved separately from the originals. The originals must be on the same memory card.
- **Multiple exposure:** a series of two to ten exposures is recorded as a single photograph. The individual exposures are not saved separately.

## Image Overlay

Overlays are created using the **Image Overlay** option in the shooting menu.

- 1 The new picture is saved at current image quality and size settings. Before creating an overlay, set image quality and size (45).
- 2 Highlight **Image Overlay** in the shooting menu (166) and press the multi selector to the right.

A preview will be displayed with **Image 1** highlighted.

- 3 Press the **ENTER** button to view the RAW images on the memory card. Press the multi selector left or right to highlight images. To zoom in on the highlighted image, press the **+** button.
- 4 Press the **ENTER** button to select the highlighted image and return to the preview display. The selected image will appear as **Image 1**.

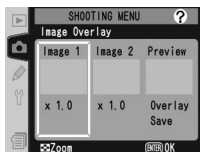
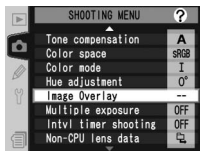

**5** Press the multi selector up or down to select a value for gain between 0.1 and 2.0. The default value is 1.0; selecting 0.5 cuts gain in half, while selecting 2.0 doubles gain. The effects of gain are visible in the preview image.

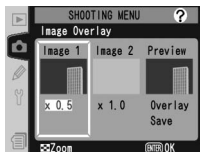

**6** Press the multi selector left or right to highlight **Image 2**. Repeat steps 3–5 to select the second image and adjust gain.

**7** Press the multi selector left or right to highlight **Overlay** and press the **ENTER** button to display a confirmation dialog (to save the new image without displaying the confirmation dialog, highlight **Save** and press the **ENTER** button). Press the **ENTER** button to save the new image, or the **BACK** button to return to the preview dialog.



### Selecting Photographs for Image Overlay

Only RAW photographs taken with the D2X can be selected for image overlay. Other images are not displayed in the thumbnail list. The two originals must be the same size: if **On** is selected for **Hi-speed Crop**, only RAW photographs taken with high-speed crop on will be displayed; if **Off** is selected, only RAW photographs taken with high-speed crop off will be displayed ( 41). Hidden images are not displayed and can not be selected.

### Image Overlay

The new image is recorded at current image quality, image size, and file name settings under a file name assigned by adding one to the largest file number in the current folder. White balance, sharpening, color space, color mode, and hue settings are copied from the photograph selected for **Image 1**, as are the date of recording, metering, shutter speed, aperture, exposure mode, exposure compensation, focal length, orientation, and other photo information. Voice memos are not copied and must be recorded separately for the new image.

## Multiple Exposure

To create a multiple exposure:

- 1 Highlight **Multiple exposure** in the shooting menu (168) and press the multi selector to the right.
- 2 Press the multi selector up or down to highlight **Number of shots** and press the multi selector to the right.
- 3 Press the multi selector up or down to choose the number of exposures that will be combined to form a single photograph. Press the multi selector to the right to return to the multiple exposure menu.
- 4 Press the multi selector up or down to highlight **Auto gain** and press the multi selector to the right.
- 5 Press the multi selector up or down to highlight one of the following options and then press the multi selector to the right.

Option	Description
<b>On</b> (default)	Gain adjusted according to number of exposures actually recorded (gain for each exposure is set to $\frac{1}{2}$ for 2 exposures, $\frac{1}{3}$ for 3 exposures, etc.).
<b>Off</b>	Gain is not adjusted when recording multiple exposure.

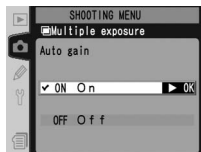
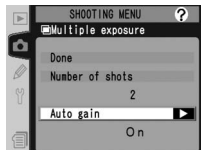
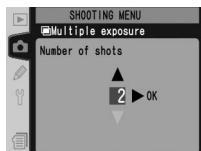
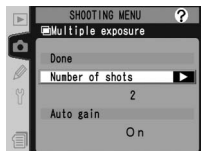
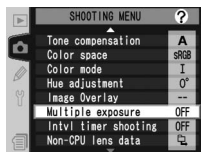

6 Press the multi selector up or down to highlight **Done** and press the multi selector to the right. A  icon will be displayed in the top control panel.

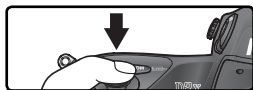
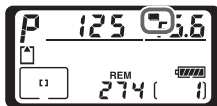
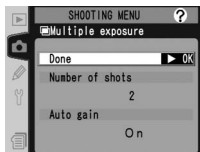



7 Frame a photograph, focus, and shoot. In continuous high-speed or continuous low-speed mode (43), the camera will record all exposures in a single burst. In single-frame shooting mode, one photograph will be taken each time the shutter-release button is pressed; continue shooting until all exposures have been recorded. Shooting will end automatically if:

- No operations are performed for 30s during shooting, or for 30s after the monitor has turned off during playback or menu operations
- The user selects **Reset** or **Cancel** in the multiple exposure menu and presses the multi selector to the right
- The camera is turned off
- The battery is exhausted
- Pictures are deleted



If shooting ends before the specified number of exposures have been taken, a multiple exposure will be created from the exposures that have been recorded to that point. If **Auto gain** is on, gain will be adjusted to reflect the number of exposures actually recorded. To end shooting without creating a multiple exposure, press the  button while turning the camera off.

The  icon will blink until shooting ends. When shooting ends, multiple exposure mode will end and the  icon will no longer be displayed. Repeat steps 1–7 to take additional multiple exposures.

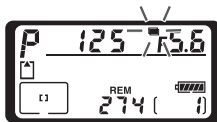

### Exchanging Memory Cards

Do not remove or replace the memory card while recording a multiple exposure.

### Photo Info

The information listed in the playback photo information display (including date of recording and camera orientation) is for the first shot in the multiple exposure.

### Voice Memos

The camera stores only the last voice memo created during a multiple exposure.



### Auto Meter Off

Unless **No limit** is selected for Custom Setting c3 (**Auto meter-off**;  193) or the camera is powered by an AC adapter, shooting will end and a multiple exposure will be recorded if no operations are performed for 30s. To prevent the exposure meters from turning off before the 30s limit has expired, 30s are added to the auto meter-off delay when shooting starts. The existing meter-off delay is restored when shooting ends.

### White Balance ( 54)

If **Auto** is selected for white balance, white balance will be fixed at a value equivalent to **Direct sunlight** while multiple exposure mode is in effect. Only use **Auto** if the subject is in direct sunlight.

### Interval Timer Photography

If interval timer photography is activated before the first exposure is taken, the camera will record exposures at the selected interval until the number of exposures specified in the multiple exposure menu have been taken (the number of shots listed in the interval timer shooting menu is ignored). These exposures will then be recorded as a single photograph and multiple exposure mode and interval timer shooting will end. Note that unless **No limit** is selected for Custom Setting c3 (**Auto meter-off**;  193) or the camera is powered by an AC adapter, shooting will end automatically if no operations are performed for 30s; when recording a multiple exposure using the interval timer, choose an interval of less than 30s, select **No limit** for Custom Setting c3 (**Auto meter-off**;  193), or use an AC adapter. Cancelling multiple exposure cancels interval timer shooting.

### Bracketing and Other Settings

Bracketing is cancelled when multiple exposure is selected and can not be restored until shooting has ended. While multiple exposure mode is in effect, memory cards can not be formatted and the following can not be changed: shooting menu options other than **Intvl timer shooting** (**Intvl timer shooting** can only be adjusted before the first exposure is taken), high-speed crop, and **Dust Off ref photo**.

### Two Button Reset ( 133)

Multiple exposure settings are not affected when a two-button reset is performed. Performing a two-button reset does not cancel multiple exposure mode.

# Interval Timer Photography

Taking Photographs at Preset Intervals

The D2X is equipped to take photographs automatically at preset intervals.

1 Highlight **Intvl timer shooting** in the shooting menu (166) and press the multi selector to the right.

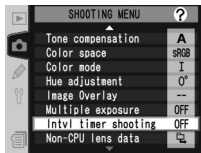

2 Press the multi selector left or right to highlight options and press the multi selector up or down to change interval timer settings. The selected option is highlighted in blue. The following options are available:



Option	Description
<b>Start</b>	Choose starting for interval timer photography from: <ul style="list-style-type: none"><li>• <b>Now</b>: Shooting begins about 3s after this option is selected</li><li>• <b>Start time</b>: Shooting begins at <b>Start time</b></li></ul>
<b>Start time</b>	Enter start time for interval timer photography when <b>Start time</b> is selected for <b>Start</b> . Press multi selector left or right to highlight starting hour or minute, press up or down to change. Not available when <b>Now</b> is selected for <b>Start</b> .
<b>Interval</b>	Enter time between shots. Press multi selector left or right to highlight hour, minute, or second, press up or down to change. Note that camera will not be able to take photographs at specified interval if interval is shorter than shutter speed or time required to record images.
<b>Select intvl*no. of shots</b>	Choose number of intervals and number of shots taken at each interval. Press multi selector left or right to highlight number of intervals or number of shots, press up or down to change. Total number of shots that will be taken appears to right.
<b>Remaining (intvl*shots)</b>	Shows number of intervals and total shots remaining in current interval program. This item can not be edited.
<b>Start</b>	Choose <b>Off</b> to exit without starting interval timer. To start interval timer, select <b>On</b> and press <b>ENTER</b> . Shooting will start at selected start time and will continue for specified number of intervals.



**3** Highlight **Start** at the bottom of the interval timer menu and press the multi selector up or down to select **On**, then press the **ENTER** button. The first series of shots will be taken at the specified starting time. Shooting will continue at the selected interval until all shots have been taken. If shooting can not proceed at current settings (for example, if a shutter speed of **1/1000** is currently selected in manual exposure mode, or the starting time is less than one minute from the current time), a warning will appear and the interval timer menu will be displayed again.

Use of a tripod is recommended.

### **Take a Test Shot**

Before beginning interval timer photography, take a test shot at current settings and view the results in the monitor. Remember that the camera will focus before each shot—no shots will be taken if the camera is unable to focus in single-servo AF.

### **Use a Reliable Power Source**

To ensure that shooting is not interrupted, be sure the battery is fully charged. If in doubt, charge the battery before shooting or use an optional EH-6 AC adapter.

### **Check the Time**

Before choosing a starting time, select **World Time** in the setup menu and make sure that the camera clock is set to the correct time and date ( 18).

### **Out of Memory**

If the memory card is full, the interval timer will remain active but no pictures will be taken. Delete some pictures or turn the camera off and insert another memory card. When the camera is turned on, interval timer photography will be paused. See “Pausing Interval Timer Photography” on the following page for information on resuming interval timer photography.

### **Bracketing**

Adjust bracketing settings before starting interval timer photography. If exposure and/or flash bracketing is active while interval timer photography is in effect, the camera will take the number of shots in the bracketing program at each interval, regardless of the number of shots specified in the interval timer menu. If white balance bracketing is active while interval timer photography is in effect, the camera will take the number of shots specified in the interval timer menu and process each shot to create the number of copies specified in the bracketing program.

### **The Viewfinder Eyepiece**

In exposure modes other than manual, close the viewfinder eyepiece shutter to prevent light entering via the viewfinder from interfering with exposure.



## During Shooting

During interval timer photography, the **INTERVAL** icon in the top control panel will blink. Immediately before the next shooting interval begins, the shutter speed display will show the number of intervals remaining, and the aperture display will show the number of shots remaining in the current interval. At other times, the number of intervals remaining and the number of shots in each interval can be viewed by pressing the shutter-release button halfway (once the button is released, the shutter speed and aperture will be displayed until the exposure meters turn off).

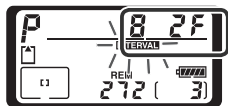

To view current interval timer settings, select **Intvl timer shooting** between shots. While interval timer photography is in progress, the interval timer menu will show the starting time, the current time, the shooting interval, the selected number of intervals and number of shots, and the number of intervals and shots remaining. None of these items can be changed while interval timer photography is in progress.

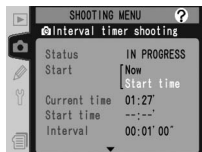

## During Shooting

Shooting and menu settings can be adjusted freely while interval timer photography is in progress. Note the following:

- Performing a two-button reset (🔍 133) or changing bracketing settings (🔍 98) will cancel interval timer photography.
- If shutter speed is set to **b** **1/3** (manual exposure mode) after the timer has started, subsequent photographs will be taken at a shutter speed of  $\frac{1}{3}$  s.
- The monitor will turn off about four seconds before each interval.
- If voice memos are recorded automatically after shooting, voice memos will end two seconds before the next photograph is taken.

## Maximum shots

If the number of shots per interval is greater than the limit specified in Custom Setting d2 (**Maximum shots**), only the number of shots specified in Custom Setting d2 will be taken at each interval.

## Pausing Interval Timer Photography

To pause interval timer photography:

- 1 Press the multi selector left or right to highlight **Start** at the bottom of the interval timer menu.
- 2 Press the multi selector up or down to select **Pause** and press the **ENTER** button.

Interval time photography can also be paused by:

- Pressing the **ENTER** button between intervals.
- Turning the camera off (if desired, the memory card can be replaced while the camera is off).

Interval timer photography will be paused when the camera is turned on.

When shooting is paused, the start time will be reset to **Now**. A new starting time can be selected as described in Step 2 of “Interval Timer Photography” (📷 122). The interval, number of intervals, and number of shots can not be changed. If interval timer photography is paused during shooting, any shots remaining in the current interval will be cancelled.

- 1 Press the multi selector left or right to highlight **Start** at the bottom of the interval timer menu (see above).
- 2 Press the multi selector up or down to select **Restart** and press the **ENTER** button.

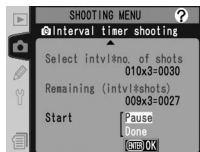

### No Photograph

Photographs will not be taken if the self-timer is in operation or the previous photograph has yet to be taken, the memory buffer or memory card is full, or the camera is unable to focus in single-servo AF (note that the camera focuses again before each shot).

### Multiple Exposure



Interval timer shooting can be used to create a multiple exposure (📷 119).

## Interrupting Interval Timer Photography

To interrupt interval timer photography:



- 1 Press the multi selector left or right to highlight **Start** at the bottom of the interval timer menu (see previous page).
- 2 Press the multi selector up or down to select **Done** and press the  button.

Interval timer photography will also be interrupted if:



- A two button reset is performed ( 133).
- **Reset shooting menu** is selected in the shooting menu ( 169).
- Bracketing settings are changed ( 98).
- The battery is exhausted.

Normal shooting will resume when interval timer photography ends.

### Shooting Mode

Regardless of the shooting mode selected, the camera will take the specified number of shots at each interval. In **CH** (continuous high speed) mode, photographs will be taken at a rate of five shots per second (eight shots per second when high-speed crop is on). In **S** (single frame), **CL** (continuous low-speed), and **M-UP** (mirror up) modes, photographs will be taken at the rate chosen for Custom Setting d1 (**Shooting speed**;  194). In  (self-timer) mode, the shutter-release delay applies to each photograph taken. In **M-UP** mode, the mirror will be raised automatically immediately before each shot.

### Shooting Menu Banks



Changes to interval timer settings apply to all shooting menu banks ( 167). If shooting menu settings are reset using the **Reset shooting menu** item in the shooting menu ( 169), interval timer settings will be reset as follows:

- Start time: **Now**
- Interval: 00:01'00"
- Number of intervals: 1
- Number of shots: 1
- Start: **Off**

# Self-Timer Mode

Delaying Shutter Release

The self-timer can be used to reduce camera shake or for self-portraits. To use the self-timer:

- 1 Mount the camera on a tripod (recommended) or place the camera on a stable, level surface.
- 2 Press the shooting mode dial lock release and rotate the shooting mode dial to select  (self-timer mode).
- 3 Frame the photograph and focus. If autofocus is in effect, be sure not to block the lens when activating the self-timer. In single-servo autofocus ( 72), photographs can only be taken if the in-focus () indicator appears in the viewfinder.

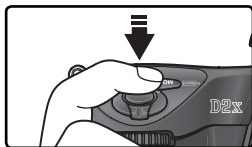

## Close the Viewfinder Eyepiece Shutter

In exposure modes other than manual, close the viewfinder eyepiece shutter after focusing. This prevents light entering via the viewfinder from interfering with exposure.



- 4 Press the shutter-release button all the way down to start the self-timer. The self-timer lamp will start to blink, stopping two seconds before the photograph is taken.

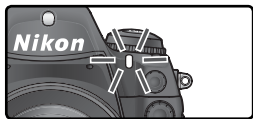
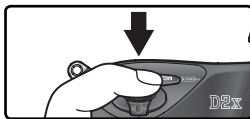

To turn the self-timer off before a photograph is taken, turn the mode dial to another setting.

## bulb

In self-timer mode, a shutter speed of **bulb** is equivalent to approximately  $\frac{1}{3}$ s.

## c4—Self-timer ( 193)

Self-timer delay can be set to 2s, 5s, 10s (the default setting), or 20s.

By specifying lens data (lens focal length and maximum aperture), the user can gain access to a variety of CPU lens functions when using a non-CPU lens. If the focal length of the lens is known:

- Automatic power zoom can be used with attached Speedlights
- Lens focal length is listed (with an asterisk) in the playback photo info display

When the maximum aperture of the lens is known:

- The aperture value is displayed in the top control panel and viewfinder
- Flash level is adjusted for changes in aperture
- Aperture is listed (with an asterisk) in the playback photo info display

Specifying both the focal length and maximum aperture of the lens:

- Enables color matrix metering (note that it may be necessary to use center-weighted or spot metering to achieve accurate results with some lenses, including Reflex-Nikkor lenses)
- Improves the precision of center-weighted and spot metering, i-TTL Balanced Fill-Flash for Digital SLR, and Multi-Sensor Balanced Fill-Flash for Digital SLR

### Specifying Lens Focal Length

Lens focal length can be specified using the **Non-CPU lens data** option in the shooting menu or by pressing the FUNC. button and rotating the main command dial. The following settings are available:

- 6–45 mm: 6, 8, 13, 15, 16, 18, 20, 24, 25, 28, 35, 43, and 45 mm
- 50–180 mm: 50, 55, 58, 70, 80, 85, 86, 100, 105, 135, and 180 mm
- 200–4000 mm: 200, 300, 360, 400, 500, 600, 800, 1000, 1200, 1400, 1600, 2000, 2400, 2800, 3200, and 4000 mm

#### The Non-CPU Lens Data Menu

- 1 Highlight **Non-CPU lens data** in the shooting menu (👁 166) and press the multi selector to the right.

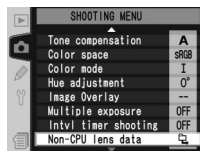

#### Focal Length Not Listed

If the correct focal length is not listed, choose the closest value greater than the actual focal length of the lens.

2 Highlight **Focal length** and press the multi selector to the right.

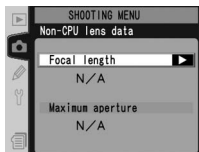

3 Select the group to which the lens belongs from **6-45**, **50-180**, **200-4000** and press the multi selector to the right.

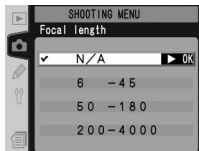

4 Select the lens focal length (in mm) and press the multi selector to the right.



### The FUNC. Button

1 Select **FV Lock/Lens data** for Custom Setting f4 (**FUNC. Button**; 205).

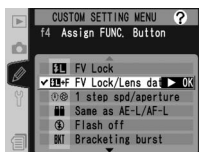

2 Press the FUNC. button and rotate the main command dial. Focal length is displayed in the top control panel:

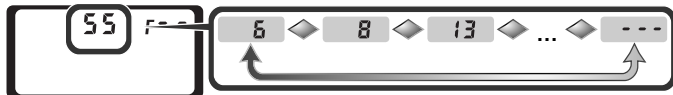

### Default Maximum Aperture

Selecting a focal length sets **Maximum aperture** to the last value selected at that focal length.

## Specifying Maximum Aperture

Lens maximum aperture can be specified using the **Non-CPU lens data** option in the shooting menu or by pressing the FUNC. button and rotating the sub-command dial. The following f/-numbers are available:

- 1.2, 1.4, 1.8, 2, 2.5, 2.8, 3.3, 3.5, 4, 4.5, 5, 5.6, 6.3, 7.1, 8, 9.5, 11, 13, 15, 16, 19, 22

### The Non-CPU Lens Data Menu

- 1 Highlight **Non-CPU lens data** in the shooting menu (166) and press the multi selector to the right.
- 2 Highlight **Maximum aperture** and press the multi selector to the right.
- 3 Select the f/-number corresponding to the maximum lens aperture and press the multi selector to the right.

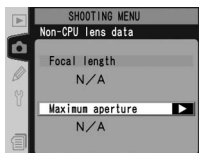
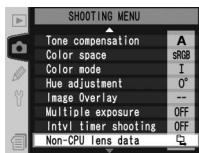

### SB-800/SB-600

If an SB-800 or SB-600 Speedlight is mounted on the camera, turn the Speedlight off before using the FUNC. button to specify lens data.

### Zoom Lenses

Lens data are not adjusted when non-CPU lenses are zoomed in or out. After changing the zoom position, select new values for lens focal length and maximum aperture.



## The FUNC. Button



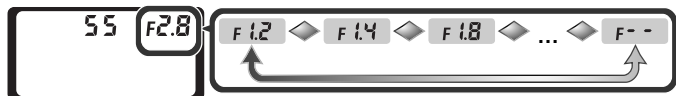
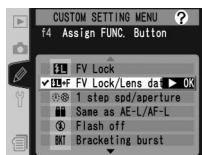

- 1 Select **FV Lock/Lens data** for Custom Setting f4 (**FUNC. Button**;  205).
- 2 Press the FUNC. button and rotate the sub-command dial. Maximum aperture is displayed in the top control panel:



Garmin and Magellan GPS units that conform to version 2.01 of the National Marine Electronics Association NMEA0183 protocol can be connected to the camera's ten-pin remote terminal using an MC-35 GPS adapter cord (available separately;  247), allowing information on the camera's current position to be recorded when photographs are taken. Operation has been confirmed with the following devices:

- Garmin eTrex series
- Magellan SporTrak series

These devices connect to the MC-35 using the cable provided by the manufacturer of the GPS device. See the MC-35 instruction manual for details. Before turning the camera on, set the GPS device to NMEA mode.



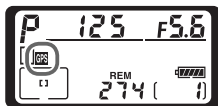

When the camera establishes communication with a GPS device, a  icon will be displayed in the top control panel. The exposure meters will not turn off while this icon is displayed. Photo information for pictures taken while the  icon is displayed will include an additional page ( 138) recording the current latitude, longitude, altitude, and Coordinated Universal Time (UTC). If no data are received from the GPS unit for two seconds, the  icon will clear from the display and the camera will stop recording GPS information.



### Coordinated Universal Time (UTC)

UTC data is provided by the GPS device and is independent of the camera clock.

### GPS Data

GPS data are only recorded when the  icon is displayed. Confirm that the  icon is displayed in the top control panel before shooting. A flashing  icon indicates that the GPS device is searching for a signal; pictures taken while the  icon is flashing will not include GPS data.

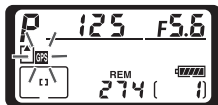

# Two-Button Reset

## Restoring Default Settings

The camera settings listed below can be restored to default values by holding the **WB** and **ISO** buttons down together for more than two seconds (these buttons are marked by a green dot). The control panels turn off briefly while settings are reset. Custom Settings are not affected.



Option	Default
Focus area	Center*
Exposure mode	Programmed auto
Flexible program	Off
Exposure compensation	±0
AE hold	Off†

\* If AF-area mode is set to group dynamic-AF, center group will be selected.

† Custom Setting c2 (**AE-L/AF-L**) is unaffected.

Option	Default
Aperture lock	Off
Shutter-speed lock	Off
Bracketing	Off‡
Flash sync mode	Front-curtain sync

‡ Number of shots is reset to zero. Bracketing increment is reset to 1 EV (exposure/flash bracketing) or 1 (white balance bracketing).

The following shooting-menu options will also be reset. Only settings in the bank currently selected using the **Shooting menu bank** option will be reset (167). Settings in the remaining banks are unaffected.

Option	Default
Image quality	JPEG Normal
Image size	Large

Option	Default
White bal.	Auto*
ISO	100

\* Fine tuning reset to 0.

### Reset Shooting Menu (169)

Other shooting menu options for the current shooting menu bank can be reset by selecting **Yes** for the **Reset shooting menu** option in the shooting menu.

### R—Menu Reset (180)

Custom Settings for the current custom settings bank can be restored to default values by selecting **Yes** for Custom Setting R (**Menu Reset**).



---

# ***More About Playback***

*Playback Options*



---

This section details the operations that can be performed during playback, including thumbnail playback, playback zoom, and photo information display.

## Single-Image Playback

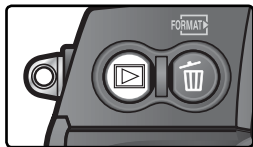
To play photographs back, press the  button. The most recent photograph will be displayed in the monitor.



To end playback and return to shooting mode, press the  button or press the shutter-release button halfway. To view camera menus ( 39), press the  button.

### Using the Multi Selector

The multi selector can be used at any time when the monitor is on. The focus selector lock switch only takes effect when the monitor is off.

### Image Review ( 164)

When **On** is selected for **Image review** in the playback menu, photographs are automatically displayed in the monitor as they are being recorded to the memory card. In single-frame, self-timer, and mirror-up modes, photographs are displayed one at a time as they are taken. In continuous shooting mode, display begins when shooting ends, with the first photograph in the current series displayed. Playback will be interrupted when the shutter-release button is pressed, and resume when the button is released after shooting.

### Rotate Tall ( 165)

This playback menu option controls whether portrait-orientation photographs taken with **On** selected for the **Auto image rotation** option in the setup menu are automatically rotated during playback.

### c5—Monitor Off ( 193)

The monitor will turn off automatically to save power if no operations are performed for the time specified in Custom Setting c5 (**Monitor off**). Press the  button again to return to playback mode.

## Photo Information

Photo information is superimposed on images displayed in single-image playback. There are up to eight pages of information for each photo. Press the multi-selector left or right to cycle through photo information as follows: (Page 5) ↔ (Page 4) ↔ (Page 3) ↔ Page 2 ↔ Page 1 ↔ (Page 6) ↔ (Page 7) ↔ (Page 8) ↔ (Page 5).

### Page 1

- |                           |                                         |
|---------------------------|-----------------------------------------|
| 1 Voice memo icon ... 147 | 3 Folder number/frame number* ..... 156 |
| 2 Protect status..... 143 |                                         |

\*Displayed in yellow if photo was taken with high-speed crop on.

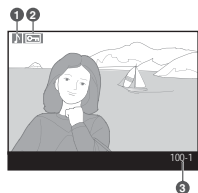

### Page 2

- |                                             |                                          |
|---------------------------------------------|------------------------------------------|
| 1 Voice memo icon ... 147                   | 7 Image size ..... 48                    |
| 2 Protect status..... 143                   | 8 Image quality ..... 45                 |
| 3 Focus brackets* ..... 74                  | 9 Date of recording..... 18              |
| 4 Frame number/total number of frames.. 156 | 10 Time of recording .... 18             |
| 5 File name..... 171                        | 11 High-speed crop ..... 41              |
| 6 Folder name ..... 156                     | 12 Folder number/frame number† ..... 156 |

\*If **Focus area** is selected for **Display mode** (164), active focus area is highlighted in red (in photos taken using single-servo AF with dynamic-area AF, group dynamic-AF, or closest-subject priority, area where focus first locked is highlighted).

†Displayed in yellow if photo was taken with high-speed crop on.

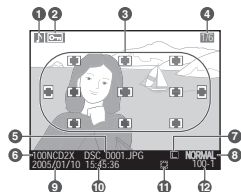

### Page 3 (Shooting Data 1)\*

- |                           |                                          |
|---------------------------|------------------------------------------|
| 1 Voice memo icon ... 147 | 8 Exposure compensation ..... 97         |
| 2 Protect status..... 143 | 9 Focal length ..... 242                 |
| 3 Camera name             | 10 High-speed crop ..... 41              |
| 4 Metering method .... 84 | 11 Folder number/frame number† ..... 156 |
| 5 Shutter speed ..... 85  |                                          |
| 6 Aperture ..... 85       |                                          |
| 7 Exposure mode ..... 85  |                                          |

\*Displayed only if **Data** is selected for **Display mode** (164).

†Displayed in yellow if photo was taken with high-speed crop on.

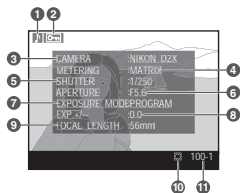

## Page 4 (Shooting Data 2)\*

- |                                            |                                             |
|--------------------------------------------|---------------------------------------------|
| 1 Voice memo icon ... 147                  | 6 Tone compensation .. 68                   |
| 2 Protect status..... 143                  | 7 Sharpening ..... 67                       |
| 3 Sensitivity<br>(ISO equivalency)† ... 52 | 8 Color mode ..... 70                       |
| 4 White balance ..... 54                   | 9 Image comment ..... 213                   |
| 5 White balance<br>adjustment ..... 56     | 10 High-speed crop ..... 41                 |
|                                            | 11 Folder number/frame<br>number+ ..... 156 |

\*Displayed only if **Data** is selected for **Display mode** (132).

†Displayed in red if photo was taken with auto ISO on.

‡Displayed in yellow if photo was taken with high-speed crop on.

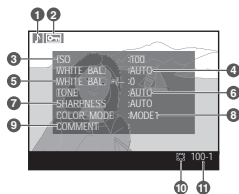

## Page 5 (GPS Data)\*

- |                           |                                            |
|---------------------------|--------------------------------------------|
| 1 Voice memo icon ... 147 | 6 Coordinated Universal<br>Time (UTC)      |
| 2 Protect status..... 143 | 7 High-speed crop ..... 41                 |
| 3 Latitude                | 8 Folder number/frame<br>number+ ..... 156 |
| 4 Longitude               |                                            |
| 5 Altitude                |                                            |

\*Displayed only if GPS device was used when photo was taken (132).

†Displayed in yellow if photo was taken with high-speed crop on.

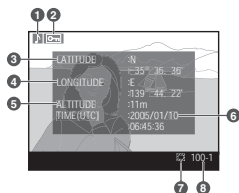

## Page 6 (Histogram)\*

- |                                                                                                                                                                                |
|--------------------------------------------------------------------------------------------------------------------------------------------------------------------------------|
| 1 Voice memo icon ..... 147                                                                                                                                                    |
| 2 Protect status..... 143                                                                                                                                                      |
| 3 Histogram showing the distribution of tones in the image. Horizontal axis corresponds to pixel brightness, vertical axis shows number of pixels of each brightness in image. |
| 4 Folder number/frame number+ ..... 156                                                                                                                                        |

\*Displayed only if **Histogram** is selected for **Display mode** (132).

†Displayed in yellow if photo was taken with high-speed crop on.

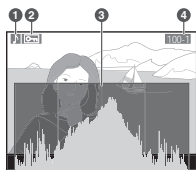



## Page 7 (Highlights)\*

- 1 Voice memo icon ..... 147
- 2 Protect status..... 143
- 3 Image highlights (areas of image that may be overexposed) are marked by a flashing border†
- 4 Current channel
- 5 Folder number/frame number† ..... 156

\*Displayed only if **Highlights** is selected for **Display mode** (164).

†Highlights can be displayed separately for each color channel. Press multi selector left or right while pressing  button to cycle through channels as follows: **RGB** (all channels) ↔ **R** (red) ↔ **G** (green) ↔ **B** (blue) ↔ **RGB**.

‡Displayed in yellow if photo was taken with high-speed crop on.

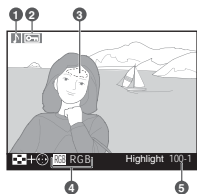

## Page 8 (RGB Histogram)\*

- 1 Voice memo icon ... 147
- 2 Protect status..... 143
- 3 Image highlights (areas of image that may be overexposed) are marked by a flashing border†
- 4 Folder number/frame number† ..... 156
- 5 Current channel
- 6 Histogram (RGB channel). In all histograms, horizontal axis gives pixel brightness, vertical axis number of pixels.
- 7 Histogram (red channel)
- 8 Histogram (green channel)
- 9 Histogram (blue channel)

\*Displayed only if **RGB histogram** is selected for **Display mode** (164).

†Highlights can be displayed separately for each color channel. Press multi selector left or right while pressing  button to cycle through channels as follows: **RGB** (all channels) ↔ **R** (red) ↔ **G** (green) ↔ **B** (blue) ↔ highlight display off ↔ **RGB**.

‡Displayed in yellow if photo was taken with high-speed crop on.

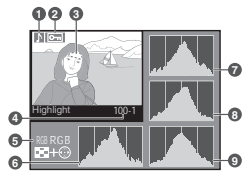

## Histograms

Camera histograms are for use only as a guide and may differ from those displayed in imaging applications.

















## f3—Photo Info/Playback (164)

The roles of the multi selector buttons can be reversed, so that the left and right buttons display other images and the up and down buttons control photo information.

## Viewing Multiple Images: Thumbnail Playback

To display images in “contact sheets” of four or nine images, press the  button and rotate the main command dial. The following operations can be performed while thumbnails are displayed:













To	Press and/or rotate	Description
Change number of images displayed	  	Press  button and rotate main command dial to change the number of images displayed as follows: single image ↔ four thumbnails ↔ nine thumbnails ↔ single image.
Toggle full frame playback		Press center of multi selector to switch back and forth between full frame and thumbnail playback.
Highlight images		Press multi selector up, right, left, or down to highlight thumbnails.
Page through images	  	Press  button and rotate sub-command dial to scroll through images a page at a time.
Delete images		Confirmation dialog will be displayed. Press  again to delete photo. To exit without deleting photo, press multi selector left or right.
Zoom in on highlighted photo	 	Press  for enlarged view of highlighted photo (  142).



### f1—Center Button > Playback Mode 202

Instead of toggling between full-frame and thumbnail playback, the center of the multi selector can be used to toggle playback zoom or display a histogram.

To	Press and/or rotate	Description
Record/ play voice memo		If voice memo has not been recorded for highlighted photo, voice memo will be recorded while  button is pressed (📖 146). If voice memo has been recorded for highlighted image, pressing  button will start playback. Press again to pause playback (📖 150).
Change protect status of highlighted photo		Images marked by  icon can not be deleted using  button or <b>Delete</b> option in playback menu (note that protected images <i>will</i> be deleted when memory card is formatted). To protect image, or to remove protection from protected image, press  button (📖 143).
Display menus		Press  button to display camera menus (📖 39).
Return to shooting mode	Shutter-release/ 	To end playback and return to shooting mode, press  button or press shutter-release button halfway.

## Using the Multi Selector

The multi selector can be used at any time when the monitor is on. The focus selector lock switch only takes effect when the monitor is off.

## Image Review (📖 164)











When **On** is selected for **Image review** in the playback menu, photographs are automatically displayed in the monitor as they are being recorded to the memory card. In single-frame and self-timer modes, photographs are displayed one at a time as they are taken. In continuous shooting mode, display begins when shooting ends. Thumbnail playback is only available in continuous shooting mode.

## c5—Monitor Off (📖 193)



The monitor will turn off automatically to save power if no operations are performed for the time specified in Custom Setting c5 (**Monitor off**). Press the  button again to return to playback mode.

## Taking a Closer Look: Playback Zoom



Press the  button to zoom in on the image displayed in single-image playback or on the image currently highlighted in thumbnail playback. The following operations can be performed while zoom is in effect:

To	Use	Description
Cancel/resume zoom	 (Q)	Press  to cancel zoom and return to single-image or thumbnail playback. Press again to zoom image in.
Select area displayed		Press  button to display frame showing area currently zoomed in. While  button is pressed, multi selector can be used to move frame and main command dial can be used to control size of frame—rotate dial counterclockwise to zoom out, clockwise to zoom in to maximum of approximately 27× (large images), 20× (medium images), or 13× (small images). Release  button to magnify selected area to fill monitor. 
View other images		Rotate main command dial to view same area of other images at current zoom ratio.
View other areas of image		Use multi selector to view area not visible in monitor. Hold multi selector down to scroll rapidly to other areas of frame. 

## Protecting Photographs from Deletion

In full-frame, zoom, and thumbnail playback, the  button can be used to protect photographs from accidental deletion. Protected files can not be deleted using the  button or the **Delete** option in the playback menu, and have DOS “read-only” status when viewed on a Windows computer. Note that protected images *will* be deleted when the memory card is formatted.

To protect a photograph:

- 1 Display the image in full-frame playback or highlight it in the thumbnail list.
- 2 Press the  button. The photograph will be marked with a .





To remove protection from the photograph so that it can be deleted, display the photograph or highlight it in the thumbnail list and then press the  button.

### Voice Memos

Changes to the protect status of images also apply to any voice memos that may have been recorded with the images. Voice memo overwrite status can not be set separately.

### Removing Protection from All Images

To remove protection from all images in the folder or folders currently selected in the **Playback folder** menu, press the  and  buttons together for about two seconds.

## Deleting Individual Photographs

To delete a photograph displayed in single-image or zoom playback, or the photograph highlighted in thumbnail playback, press the  button. Once deleted, photographs can not be recovered.

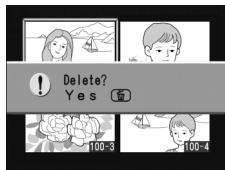

- 1 Display the image or highlight it in the thumbnail list.
- 2 Press the  button. A confirmation dialog will be displayed.



- 3 To delete the photograph, press the  button again. To exit without deleting the photograph, press the multi selector left or right.

### Voice Memos

If a voice memo has been recorded with the selected image, the confirmation dialog shown at right will be displayed when the  button is pressed.

- **Image/Sound:** Select this option and press the  button to delete both photo and voice memo.
- **Sound only:** Select this option and press the  button to delete only the voice memo.



To exit without deleting either voice memo or photo, press multi selector left or right.

### Protected and Hidden Images

Images marked with a  icon are protected and can not be deleted. Hidden images are not displayed in single-image or thumbnail playback and can not be selected for deletion.

#### Delete 154

To delete multiple images, use the **Delete** option in the playback menu.

#### After Delete 165

The **After delete** option in the playback menu determines whether the next image or the previous image is displayed after an image is deleted.

---



# **Voice Memos**

*Recording and Playback*

---

The D2X is equipped with a built-in microphone, allowing voice memos to be added to photographs. Voice memos can be played back over the camera's built-in speaker.

## Recording Voice Memos

Voice memos up to sixty seconds long can be added to photographs using the built-in microphone. In shooting mode, a voice memo can be added to the most recent photograph. In playback mode, voice memos can be added to photographs displayed in single-image playback or selected in the thumbnail list.

1 Ready the camera for recording.

### *Shooting Mode*

At default settings, voice memos can not be recorded in shooting mode. To enable automatic or manual voice memo recording, select the appropriate option for **Voice memo** in the camera setup menu (📷 209). Voice memos can only be added to the last photograph taken.

### *Playback Mode*

Display the photograph to which the memo is to be added (single-image playback) or highlight the photograph in the thumbnail list (thumbnail playback). Only one voice memo can be recorded per image; additional voice memos can not be recorded for images already marked with a 🎵 icon.

2 Press and hold the 🗣️ button. A voice memo will be recorded while the button is held down (note that no voice memo will be recorded if the 🗣️ button is not held down for at least one second).



### *🗣️ Automatic Recording (Shooting Mode)*

If **On (auto and manual)** is selected for **Voice memo**, a voice memo will be recorded for the last photograph taken when the shutter-release button is released after shooting. Recording will end when the 🗣️ button is pressed or after the specified recording time has ended.



### *🔪 Dust Off Ref Photos*

Voice memos can not be recorded for Image Dust Off reference data (📷 217).



## ✎ Interrupting Recording

Recording will end automatically if:

- The  button is pressed to display the menus
- The  button is pressed
- The shutter-release button is pressed halfway
- The camera is turned off

During interval timer photography, recording will end automatically about two seconds before the next photograph is taken.

## ✎ During Recording

During recording, the  icons in the rear control panel and viewfinder sidebar will blink. A countdown timer in the rear control panel shows the length of the voice memo that can be recorded (in seconds).

In playback mode, a  icon is displayed in the monitor during recording.

Rear control panel      Viewfinder



Monitor



Rear control panel      Viewfinder



Viewfinder



Monitor



## ✎ After Recording

If a voice memo has been recorded for the most recent photograph, a  icon will be displayed in the rear control panel and viewfinder sidebar.

If a voice memo exists for the photograph currently selected in playback mode, a  icon will be displayed in the monitor.

## 📁 Voice Memo File Names

Voice memos are stored as WAV files with names of the form "xxxxnnnn.WAV," where "xxxxnnnn" is a file name copied from the image with which the voice memo is associated. For example, the voice memo for the image "DSC\_0002.JPG" would have the file name "DSC\_0002.WAV." Voice memo file names can be viewed on a computer.



## Voice Memo Recording Options

Three setup menu options control voice memo recording: **Voice memo**, **Voice memo overwrite**, and **Voice memo button**.

### Voice Memo

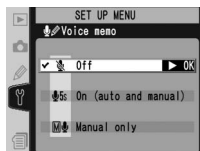
To choose a voice memo option for shooting mode, highlight **Voice memo** in the setup menu (209) and press the multi selector to the right. The following options are available:



Option	Description
<b>Off</b> (default)	Voice memos can not be recorded in shooting mode.
<b>On</b> (auto and manual)	Selecting this option displays menu shown at right; select maximum recording time from 5, 10, 20, 30, 45, or 60s. Unless <b>On</b> is selected for <b>Image review</b> in playback menu, recording will begin when shutter-release button is released after shooting. Recording ends when  button is pressed or after specified recording time has ended.
<b>Manual only</b>	Memo can be recorded for most recent photograph by pressing and holding  button (146).

### Voice Memo

The option selected for **Voice memo** is indicated by an icon in the rear control panel.



On (auto and manual)



Manual only

### Voice Memo Overwrite

This option controls whether the voice memo for the most recent photograph can be overwritten in shooting mode. Highlight **Voice memo overwrite** in the setup menu (🔑 209) and press the multi selector to the right. The following options are available:

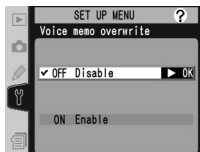

Option	Description
<b>Disable</b> (default)	Voice memo can not be recorded in shooting mode if one already exists for most recent image.
<b>Enable</b>	Voice memo can be recorded in shooting mode even if one already exists for most recent image. Existing memo will be deleted and replaced by new memo. Voice memos can not be overwritten in playback mode.

### Voice Memo Button

This option controls manual recording. Highlight **Voice memo button** in the setup menu (🔑 209) and press the multi selector to the right. The following options are available:

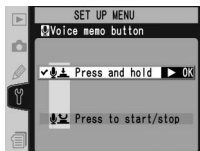







Option	Description
<b>Press and hold</b> (default)	Voice memo is recorded while 🗣️ button is held down. Recording will end automatically after 60s.
<b>Press to start/ stop</b>	Recording begins when 🗣️ button is pressed and ends when 🗣️ button is pressed again. Recording will end automatically after 60s.

## Playing Voice Memos



Voice memos can be played back over the camera's built-in speaker when the associated image is viewed in single-frame playback or highlighted in the thumbnail list. The presence of a voice memo is indicated by an  icon.



To	Press	Description
Start/end playback		Press  to start playback. Playback will end when  button is pressed again or entire memo has been played back.
Delete voice memo		Confirmation dialog will be displayed. Press multi selector up or down to highlight option, press  to select. <ul style="list-style-type: none"> <li>• <b>Image/Sound:</b> Delete both photo and voice memo.</li> <li>• <b>Sound only:</b> Delete voice memo only.</li> </ul> To exit without deleting image or voice memo, press multi selector left or right. 

### Interrupting Playback

Playback will end automatically if:



- The  button is pressed to display the menus
- The monitor is turned off by pressing the  button or by pressing the shutter-release button halfway
- The camera is turned off
- Another image is displayed (single-image playback) or another thumbnail is highlighted (thumbnail playback)

## Voice Memo Playback Options

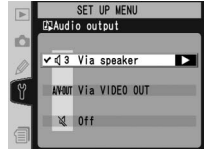
The **Audio output** option in the setup menu controls whether voice memos are played back over the camera's built-in speaker or by a device to which the camera is connected via the EG-D2 audio/video cable. When sound is played back over the built-in speaker, the **Audio output** option also controls playback volume.



Highlight **Audio output** in the setup menu (209) and press the multi selector to the right. The following options are available:

Option	Description
<b>Via speaker</b> (default)	Voice memos are played back over built-in speaker. Selecting this option displays menu shown at right. Press multi selector up or down to change volume. Beep will sound when option is selected. Press multi selector to right to make selection and return to setup menu. 
<b>Via VIDEO OUT</b>	Audio signal output to A/V-OUT terminal.
<b>Off</b>	Video memos are not played back.  icon is displayed when photo for which voice memo exists is viewed in monitor.



# Menu Guide

*Index to Menu Options*

The Playback Menu

 154–165



The Shooting Menu

 166–175



Custom Settings

 176–208



The Setup Menu

 209–227



Changes to a variety of camera settings are made with the help of menus that appear in the camera monitor. This chapter covers:

### *The Playback Menu*

The playback menu contains options for managing the images stored on memory cards, and for playing pictures back in automated slide shows.

### *The Shooting Menu*

The shooting menu contains advanced shooting options, such as image sharpening and tone compensation.

### *Custom Settings*

The CSM (Custom Settings) menu controls fine details of camera operation.

### *The Setup Menu*

This menu is used for basic camera setup operations, including formatting memory cards and setting the time and date.

The playback menu contains the following options:

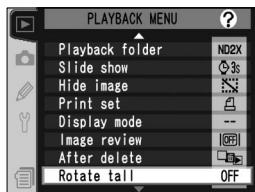
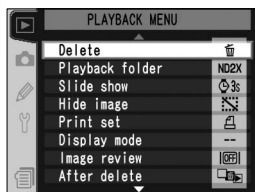

Option	Page
Delete	154–155
Playback folder	156
Slide show	157–158
Hide image	159–160
Print set	161
Display mode	164
Image review	164
After delete	165
Rotate tall	165

The playback menu is only displayed if there is a memory card in the camera.

## Delete

To display the delete menu, highlight **Delete** and press the multi selector to the right. Press the multi selector up or down to highlight an option, then press to the right to make a selection.



Option	Description
<b>Selected</b>	Delete selected photographs.
<b>All</b>	Delete all photographs.

### High-Capacity Memory Cards

If the memory card contains a large number of files or folders and the number of pictures to be deleted is very large, deletion can sometimes take more than half an hour.

### Protected and Hidden Images

Images marked with a icon are protected and can not be deleted. Hidden images ( 159) are not displayed in the thumbnail list and can not be selected for deletion.

### Using the Multi Selector

The multi selector can be used at any time when the monitor is on. The focus selector lock switch only takes effect when the monitor is off.



## Deleting Selected Photographs: *Selected*

Choosing **Selected** displays the photographs in the folder or folders selected in the **Playback folder** menu (156) as small thumbnail images.

1

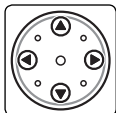

Highlight image. (To view highlighted image full screen, press . Press again to return to thumbnail list.)

2

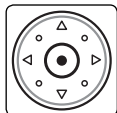

Select highlighted image. Selected image marked by icon.

3

Repeat steps 1 and 2 to select additional pictures. To deselect picture, highlight and press center of multi selector. To exit without deleting pictures, press button.

4

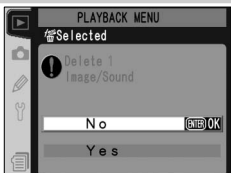

Confirmation dialog displayed. Press multi selector up or down to highlight option, press to select.

- **Yes:** delete selected pictures and any associated voice memos
- **No:** exit without deleting images

## Deleting All Photographs: *All*

Choosing **All** displays the confirmation dialog shown at right. Press the multi selector up or down to highlight an option, then press the button to make a selection.

- **Yes:** delete all images in the folder or folders selected in the **Playback folder** menu (156), together with any associated voice memos. Pictures that are protected or hidden will not be deleted.
- **No:** exit without deleting images.



## Playback Folder

To display the playback folder menu, highlight **Playback folder** in the playback menu (154) and press the multi-selector to the right. Press the multi-selector up or down to highlight an option, then press to the right to make a selection.

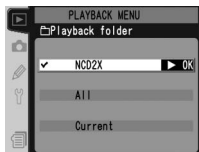

Option	Description
<b>NCD2X</b>	Images in all folders created by the D2X will be visible during playback.
<b>All</b>	Images in all folders created by cameras that conform to the Design Rule for Camera File System (DCF)—all Nikon digital cameras and most other makes of digital camera—will be visible during playback.
<b>Current</b>	Only images in the current folder will be visible during playback.

### Selecting a Folder for Storage

The **Active folder** option in the shooting menu is used to create new folders and to select the folder in which subsequent photographs will be stored (170).

### "Current"

If multiple folders are created using the **Active folder**>**New** option in the shooting menu (170), only photographs in the folder selected in the **Active folder** menu will be played back when **Current** is selected for **Playback folder**. To view photographs in other folders, select **NCD2X** or **All**.

## Slide Show

To play images back one after the other in an automated “slide show,” highlight **Slide show** in the playback menu (📄 154) and press the multi selector to the right. Press the multi selector up or down to highlight an option, then press to the right to make a selection.



Option	Description
<b>Start</b>	Start slide show.
<b>Frame interval</b>	Choose how long each picture will be displayed.
<b>Audio playback</b>	Display menu of voice memo playback options.

### Starting the Slide Show: Start

To start the slide show, highlight **Start** and press the multi selector to the right. All photographs in the folder or folders selected in the **Playback folder** menu (📄 156) will be played back in the order recorded, with a pause between each image. Hidden photographs (📄 159) will not be played back. The following operations can be performed during a slide show:

To	Press	Description
Go forward or back one frame		Press multi selector up to return to previous frame, down to skip to next frame.
View photo info		Press multi selector left or right to change photo info displayed during slide show.
Pause		Press <b>ENTER</b> to pause slide show (📄 158).
Exit to playback menu		Press <b>MENU</b> to end slide show and display playback menu.
Exit to playback mode		Press <b>▶</b> to end slide show and return to playback with current image displayed in monitor.
Exit to shooting mode	Shutter release	Press shutter-release button halfway to end slide show, turn monitor off, and return to shooting mode (voice memo playback will not be interrupted).

The dialog shown at right is displayed when the show ends or when the **ENTER** button is pressed to pause playback. Press the multi selector up or down to highlight an option, then press to the right to make a selection.



- **Restart:** Resume slide show.
- **Frame interval:** Change the length of time each picture is displayed.
- **Audio playback:** Display a menu of voice memo playback options.

To exit the slide show and return to the playback menu, press the multi selector to the left or press the **MENU** button.

### Changing the Display Interval: *Frame Interval*

To change the time each image is displayed, highlight **Frame interval** in the **Slide show** or pause menu and press the multi selector right. Press the multi selector up or down to highlight the appropriate option and then press the multi selector to the right to return to the previous menu.

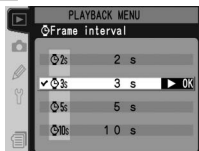

### Voice Memo Playback Options: *Audio Playback*

Selecting **Audio playback** in the **Slide show** or pause menu displays the menu shown at right. Press the multi selector up or down to highlight an option, then press to the right to make a selection.



Option	Description
<b>Off</b>	Voice memos are not played back during slide shows.
<b>On</b>	<p>Voice memos are played back during slide shows. Menu shown at right will be displayed; press multi selector up or down to highlight option, press to right select.</p> <ul style="list-style-type: none"> <li>• <b>Frame interval:</b> Playback ends when next frame is displayed, even if entire memo has not been played.</li> <li>• <b>Length of voice memo:</b> Next frame is not displayed until entire memo has been played, even if frame interval is shorter than voice memo.</li> </ul>

## Hide Image

The **Hide image** option is used to hide or reveal selected photographs. Hidden images are visible only in the **Hide image** menu, and can only be deleted by formatting the memory card.

Highlight **Hide image** in the playback menu (154) and press the multi selector to the right. Press the multi selector up or down to highlight an option, then press right to make a selection.

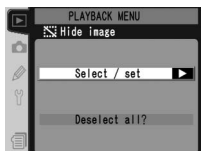



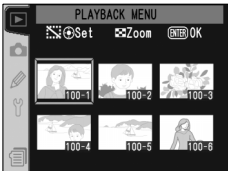

Option	Description
<b>Select/set</b>	Hide or reveal selected photographs.
<b>Deselect all?</b>	Reveal all photographs.

### Hiding Selected Photographs: *Select/Set*

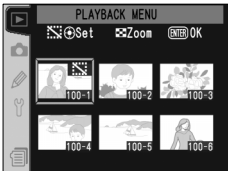
Choosing **Select/set** displays the photographs in the folder or folders selected in the **Playback folder** menu (156) as small thumbnail images.

- 

Highlight image. (To view highlighted image full screen, press **ENTER**. Press again to return to thumbnail list.)
- 

Select highlighted image. Selected image marked by  icon.
- Repeat steps 1 and 2 to select additional pictures. To deselect picture, highlight and press center of multi selector. To exit without changing hidden status of pictures, press **ENTER** button.
- 

Complete operation and return to playback menu.

## Revealing All Photographs: *Deselect All*

Choosing **Deselect all?** displays the confirmation dialog shown at right. Press the multi selector up or down to highlight an option, then press the **ENTER** button to make a selection.

- **Yes:** reveal all images in the folder or folders selected in the **Playback folder** menu (156). The monitor will briefly show the message “Hide image done,” and then the playback menu will be displayed.
- **No:** exit to the playback menu without changing the hidden status of images.

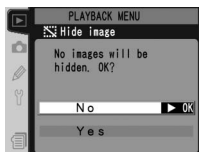

### File Attributes for Hidden Images

Hidden images have “hidden” and “read-only” status when viewed on a Windows computer. In the case of “NEF+JPEG” images, this marking applies to both the NEF (RAW) and JPEG image.

### Protected and Hidden Images

Removing protection from an image that is both hidden and protected will simultaneously reveal the image.

## Print Set

**Print set** is used to create a digital “print order” that lists the photographs to be printed, the number of copies, and the information to be included on each print. This information is stored on the memory card in Digital Print Order Format (DPOF). The card can then be removed from the camera and used to print the selected images printed on any DPOF-compatible device.

Highlight **Print set** in the playback menu (🔍 154) and press the multi selector to the right. Press the multi selector up or down to highlight an option, then press to the right to make a selection.

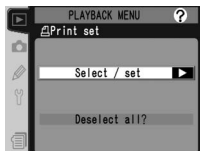

Option	Description
<b>Select/set</b>	Select photographs for printing.
<b>Deselect all?</b>	Remove all images from print order.

### 🔍 Print Set

**Print set** will not be available if there is not enough space on the memory card to record the print order. Delete unwanted pictures and try again.

### 🔍 NEF Images

Images created at image quality settings of **NEF (Raw)** (🔍 45) can not be selected for printing using this option.

### 🔍 Taking Pictures for Direct Printing

When taking images to be printed without modification, set the **Color space** option in the shooting menu to **sRGB** (🔍 69).

### 🔍 DPOF/PictBridge

Digital Print Order Format (DPOF) is an industry-wide standard that allows pictures to be printed from print orders stored on the memory card. Before printing, check that the printer or print service supports DPOF. Pictures selected using **Print set** can also be printed on PictBridge printers via direct USB connection (🔍 234). When a PictBridge printer is connected to the camera using the supplied UC-E4 USB cable, a menu will be displayed in the camera monitor; select **Print (DPOF)** to print the current print order. Note that the date and shooting information will not be printed.

## Modifying the Print Order: *Select/Set*

Choosing **Select/set** displays the photographs in the folder or folders selected in the **Playback folder** menu (156) as small thumbnail images.

1

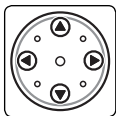

Highlight image. (To view highlighted image full screen, press . Press again to return to thumbnail list.)

2

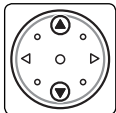

Press button and press multi selector up or down to specify number of prints (up to 99), or press center of multi selector to select image and set number of prints to 1. Selected images are marked by icon.

3

Repeat steps 1 and 2 to select additional pictures. To deselect picture, highlight and press center of multi selector. To exit without changing print order, press button.

4

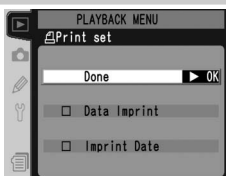

Complete print order and display menu of print options. Press multi selector up or down to highlight option.

- To print shutter speed and aperture on all pictures in print order, highlight **Data imprint** and press multi selector to right. ✓ will appear next to item.
- To print date of recording on all pictures in print order, highlight **Imprint date** and press multi selector to right. ✓ will appear next to item.
- To deselect checked item, highlight and press multi selector to right.

To complete print order and return to playback menu, highlight **Done** and press multi selector to right. To exit without altering print order, press button.



## Removing All Images from the Print Order: *Deselect All*

Choosing **Deselect all?** displays the confirmation dialog shown at right. Press the multi selector up or down to highlight an option, then press the **ENTER** button to make a selection.



- **Yes:** remove all images from the print order. The monitor will briefly show the message "Print set done," and then the playback menu will be displayed.
- **No:** exit to the playback menu without changing the print order.

### **After Creating a Print Order**

After creating a print order, do not change the hidden status of images in the print order or use a computer or other device to delete images. Either action could cause problems during printing.

### **Exif version 2.21**

The D2X supports Exif (Exchangeable Image File Format for Digital Still Cameras) version 2.21, a standard that allows information stored with photographs to be used for optimal color reproduction when images are output on Exif-compliant printers.

## Display Mode

To choose the information listed in the photo-information display (📷 137), highlight **Display mode** in the playback menu (📷 154) and press the multi-selector to the right. Press the multi-selector up or down to highlight options, then press to the right to make a selection. A ✓ appears next to selected items; to deselect, highlight and press the multi-selector to the right. To return to the playback menu, highlight **Done** and press the multi-selector to the right.



Option	Description
<b>Data*</b>	Shooting data appears in photo information display.
<b>Histogram</b>	Histogram appears in photo information display.
<b>Highlights*</b>	Highlight page appears in photo information display.
<b>RGB histogram*</b>	Histogram appears in photo information display.
<b>Focus area</b>	Active focus area (if single-servo AF is used with dynamic-area AF, group dynamic-AF, or closest-subject priority, area where focus first locked) is shown in red in photo information display.

\* Default selection.

## Image Review

**Image review** controls whether or not photographs are displayed in the monitor immediately after shooting. Highlight **Image review** in the playback menu (📷 154) and press the multi-selector to the right. Press the multi-selector up or down to highlight an option, then press to the right to make a selection.



Option	Description
<b>Off</b>	Photographs are not automatically displayed after shooting.
<b>On</b>	Photographs are automatically displayed after shooting.

## After Delete

To choose whether the following or previous picture is displayed after an image is deleted, highlight **After delete** in the playback menu (🔍 154) and press the multi selector to the right. Press the multi selector up or down to highlight an option, then press to the right to make a selection.

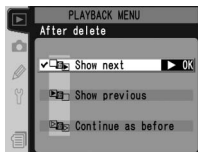

Option	Description
<b>Show next</b> (default)	After image is deleted, following image is displayed or highlighted in thumbnail list. If deleted image was last frame in memory, previous frame will be displayed or highlighted.
<b>Show previous</b>	After image is deleted, previous image is displayed or highlighted in thumbnail list. If deleted image was first frame in memory, following frame will be displayed or highlighted.
<b>Continue as before</b>	If user was scrolling through images in order recorded before deletion, following image will be displayed or highlighted (if deleted image was last frame in memory, previous frame will be displayed or highlighted). If user was scrolling through images in reverse order, previous image will be displayed or highlighted (if deleted image was first frame in memory, following frame will be displayed or highlighted).

## Rotate Tall

To choose whether photographs taken in “tall” (portrait) orientation are automatically rotated for display in the monitor, highlight **Rotate tall** in the playback menu (🔍 154) and press the multi selector to the right. Press the multi selector up or down to highlight an option, then press to the right to make a selection.

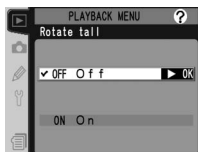

Option	Description
<b>Off</b> (default)	“Tall” (portrait) orientation photos are not displayed in tall orientation.
<b>On</b>	“Tall” (portrait) orientation photos taken with <b>On</b> selected for <b>Auto image rotation</b> (🔍 214) are displayed in tall orientation during playback (tall orientation images are displayed at 2/3 size of other images to fit monitor).

# The Shooting Menu

Shooting Options

The shooting menu contains three pages of options:

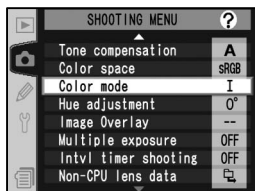
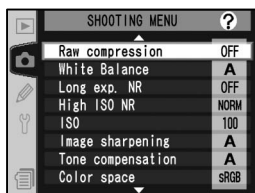
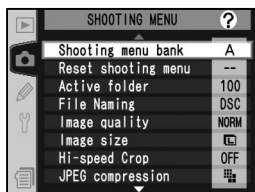

Option	
Shooting menu bank	167–168
Reset shooting menu	169
Active folder	170
File Naming	171
Image quality*	45–46
Image size*	48–49
Hi-speed Crop	41–42
JPEG compression	47
Raw compression	48
White Balance*	54–66
Long exp. NR	173
High ISO NR	173
ISO*	52–53
Image sharpening	67
Tone compensation	68
Color space	69
Color mode	70
Hue adjustment	71
Image Overlay	117–118
Multiple exposure	119–121
Intvl timer shooting	122–126
Non-CPU lens data	128–131

\* Reset to defaults when a two-button reset is performed (133).

Press the multi selector up or down to scroll between pages.

## Using the Multi Selector

The multi selector can be used at any time when the monitor is on. The focus selector lock switch only takes effect when the monitor is off.

## Shooting Menu Bank

All shooting menu options except interval timer and multiple exposure settings are stored in one of four banks. Changes to settings in one bank have no effect on the others. To store a particular combination of frequently-used settings, select one of the four banks and set the camera to these settings. The new settings will be stored in the bank even when the camera is turned off, and will be restored the next time the bank is selected. Different combinations of settings can be stored in the other banks, allowing the user to switch instantly from one combination to another by selecting the appropriate bank from the bank menu.

The default names for the four shooting menu banks are A, B, C, and D. A descriptive caption can be added using the **Rename** option.

To display the bank menu, highlight **Shooting menu bank** in the shooting menu (166) and press the multi selector to the right. Press the multi selector up or down to highlight an option, then press to the right to make a selection.

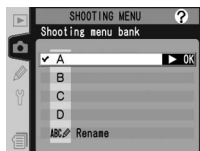

Option	Description
<b>A*</b> (default)	Select bank A.
<b>B*</b>	Select bank B.
<b>C*</b>	Select bank C.
<b>D*</b>	Select bank D.
<b>Rename</b>	Rename selected bank.

\* Descriptive caption will also be displayed if bank has been renamed.

### Sensitivity (ISO Equivalency)

If a bank in which ISO has been set to **HI-1** or **HI-2** is chosen after **On** is selected for Custom Setting b1 (**ISO auto**; 188), sensitivity (ISO equivalency) will not be adjusted automatically.

### Shooting Menu Bank

The rear control panel shows the bank currently selected in the shooting menu bank menu.



## Renaming Shooting Menu Banks

1 Highlight **Rename** and press the multi selector to the right.

2 A list of shooting menu banks will be displayed. Highlight the desired bank and press the multi selector to the right.

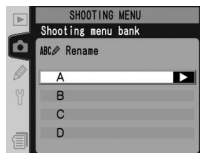

3 The following dialog will be displayed. Enter a name as described below.

### Keyboard area

Use multi selector to highlight letters, press center of multi selector to select.



### Name area

Name appears here. To move cursor, press button and use multi selector.

To move the cursor in the name area, press the button and use the multi selector. To enter a new letter at the current cursor position, use the multi selector to highlight the desired character in the keyboard area and press the center of the multi selector. To delete the character at the current cursor position, press the button. To return to the shooting menu without changing the bank name, press the button.

Bank names can be up to twenty characters long. Any characters after the twentieth will be deleted.

4 After editing the name, press to return to the bank menu.

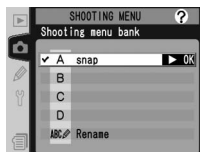

## Reset Shooting Menu

To restore default settings for the current shooting menu bank (👁 167), highlight **Reset shooting menu** in the shooting menu (👁 166) and press the multi selector to the right. Press the multi selector up or down to highlight an option, then press to the right to make a selection.

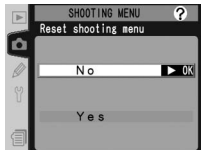

Option	Description
<b>No</b>	Exit menu, leaving settings unchanged.
<b>Yes</b>	Restore settings to default values.

The following settings are affected:

Option	Default
File naming	DSC
Image quality*	JPEG Normal
Image size*	Large
Hi-speed crop	Off
JPEG compression	Size priority
Raw compression	NEF (Raw)
White balance.*	Auto†
Long exp. NR	Off
High ISO NR	On (Normal)
ISO*	100
Image sharpening	Auto
Tone compensation	Auto
Color space	sRGB
Color mode	I

\* Defaults can also be restored by performing two-button reset (👁 133).

† Fine tuning reset to 0.

Option	Default
Hue	0
Multiple exposure†	
Number of shots	2
Auto gain	On
Interval timer shooting†	
Start time	Now
Interval	00:01:00"
No. of intervals	1
No. of shots	1
Start	Off
Non-CPU lens data	
Focal length	N/A
Maximum aperture	N/A

† Applies to all banks. Shooting ends when reset is performed.

## Active Folder

To select the folder in which subsequent images will be stored, highlight **Active folder** in the shooting menu (166) and press the multi selector to the right. Press the multi selector up or down to highlight an option, then press to the right to make a selection.

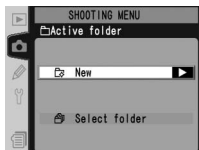

Option	Description
<b>New</b>	Dialog shown at right will be displayed; press multi selector up or down to choose number for new folder. Press multi selector to right to create new folder and return to shooting menu. Subsequent photographs will be stored in new folder.
<b>Select folder</b>	List of existing folders will be displayed; press multi selector up or down to highlight folder, press to right to select and return to shooting menu. Subsequent photographs will be stored in selected folder.



### Number of Folders

Additional time will be required for recording and playback if the memory card contains a very large number of folders.

### Automatic Folder Creation

If the current folder contains 999 files, or if sequential file numbering (196) is on and the current folder contains a picture numbered 9999, the camera will automatically create a new folder for the next picture by adding one to the current folder number. If the memory card already contains a folder numbered 999, the shutter release will be disabled. If sequential file numbering is on, the shutter release will also be disabled if the current folder is numbered 999 and contains a picture numbered 9999. To continue shooting, create a folder with a number less than 999, or select an existing folder with a number less than 999 and less than 999 images.

### Creating a Folder at Startup

If the button is pressed when the camera is turned on, a new folder will be created by adding one to the current folder number if no empty folders already exist.



## File Naming

Photographs are saved using file names consisting of “DSC\_” or “\_DSC\_” followed by a four-digit file number and a three-letter extension (e.g., “DSC\_0001.JPG”). The **File Naming** option is used to change the “DSC” portion of the file name.

Highlight **File Naming** in the shooting menu (▶ 166) and press the multi selector to the right. The menu shown at right will be displayed; press the multi selector to the right to display the following dialog.

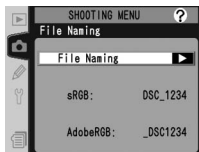

### Keyboard area

Use multi selector to highlight letters, press center of multi selector to select.

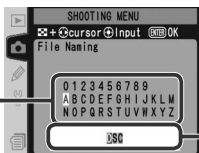

### Prefix area

File name prefix appears here. To move cursor left or right, press and use multi selector.

To move the cursor left or right in the prefix area, press the button and use the multi selector. To enter a new letter at the current cursor position, use the multi selector to highlight the desired character in the keyboard area and press the center of the multi selector. To delete the character at the current cursor position, press the button. To return to the shooting menu without changing the file naming rule, press the button.

After editing the file name prefix, press to return to the shooting menu. New photographs will be saved using the new file naming rule.

## Image Quality

Eight options are available for image quality. See “Taking Photographs: Image Quality and Size” (▶ 45).

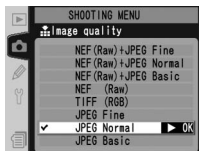

## Image Size

Image size can be selected from **Large**, **Medium**, and **Small**. See “Taking Photographs: Image Quality and Size” (📷 48).

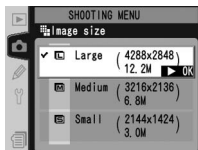

## Hi-Speed Crop

Select **On** to shoot only the area in the viewfinder high-speed crop, increasing the frame advance rate to up to 8fps and allowing more images to be stored in the memory buffer. See “Taking Photographs: High-Speed Crop” (📷 41).

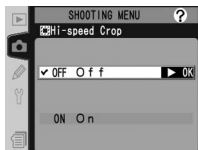

## JPEG Compression

Choose whether to compress JPEG images to a fixed size or to vary file size for improved image quality. See “Taking Photographs: Image Quality and Size” (📷 47).

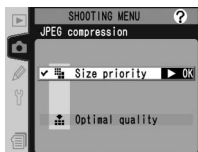

## Raw Compression

Choose whether to compress NEF (RAW) images created at image-quality settings of **RAW+JPEG (Fine)**, **RAW+JPEG (Normal)**, **RAW+JPEG (Basic)**, and **NEF (Raw)**. See “Taking Photographs: Image Quality and Size” (📷 48).

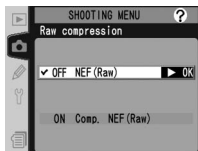

## White Balance

Nine options are available for white balance. See “Taking Photographs: White Balance” (📷 54).



## Long Exp. NR

Photographs taken at shutter speeds of 1/2s or slower can be processed to reduce “noise” in the form of randomly-spaced, brightly-colored pixels. Highlight **Long exp. NR** in the shooting menu (📷 166) and press the multi selector to the right. Press the multi selector up or down to highlight an option, then press to the right to make a selection.



Option	Description
<b>Off</b> (default)	Noise reduction off; camera functions normally.
<b>On</b>	Noise reduction takes effect at shutter speeds of about 1/2s or slower. Time needed to process images more than doubles and number of images that can be stored in memory buffer is halved. During processing, <b>Job nr</b> blinks in shutter-speed/aperture displays. Next photo can be taken when <b>Job nr</b> is no longer displayed. Note that if photographs are played back during processing, the image displayed in the monitor may not show the effects of noise reduction.

## High ISO NR

Photographs taken at high sensitivities can be processed to reduce “noise.” Highlight **High ISO NR** in the shooting menu (📷 166) and press the multi selector to the right. Press the multi selector up or down to highlight an option, then press to the right to make a selection.

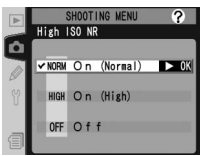

Option	Description
<b>On (Normal)</b> (default)	Noise reduction takes effect at sensitivities of ISO 400–800 or if sensitivity is raised to 400 or higher when <b>On</b> is selected for Custom Setting b1 ( <b>ISO auto</b> ), increasing processing time and reducing capacity of memory buffer. Increased noise reduction is performed at sensitivities of <b>HI-1</b> and <b>HI-2</b> or when <b>On (High)</b> is selected.
<b>On (High)</b>	
<b>Off</b>	Noise reduction turns off except at sensitivities of <b>HI-1</b> and <b>HI-2</b> .

## ISO

Sensitivity (ISO equivalency) can be increased from the default value (100). Settings of **HI-1** and **HI-2** are only available when Custom Setting b1 (**ISO auto**) is off. See “Taking Photographs: Sensitivity (ISO Equivalency)” (👁 52).



## Image Sharpening

Seven options are available for image sharpening. See “Taking Photographs: Image Adjustment” (👁 67).



## Tone Compensation

Five options are available for controlling image contrast. See “Taking Photographs: Image Adjustment” (👁 68).



## Color Space

Choose from sRGB and Adobe RGB color spaces. See “Taking Photographs: Image Adjustment” (👁 69).

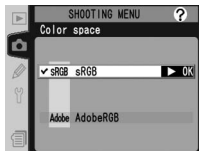

## Color Mode

Choose from three color modes. See “Taking Photographs: Image Adjustment” (👁 70).

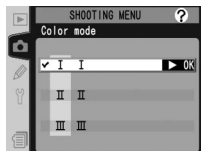

## Hue Adjustment

Hue can be set to values between approximately  $-9^\circ$  and  $+9^\circ$  in seven increments of roughly  $3^\circ$ . See “Taking Photographs: Image Adjustment” (71).

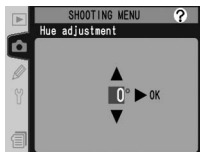

## Image Overlay

Create a new image by superimposing two existing RAW photographs. The RAW photographs must have been created using the D2X and be on the same memory card. See “Taking Photographs: Overlay/Multiple Exposure” (117).

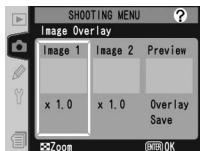

## Multiple Exposure

Create a single photograph from two to ten exposures. See “Taking Photographs: Overlay/Multiple Exposure” (119).

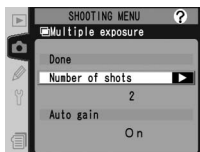

## Interval Timer Shooting

Take photographs automatically at pre-selected intervals. See “Taking Photographs: Interval Timer Photography” (122).



## Non-CPU Lens Data

Specifying the focal length and maximum aperture allows such features as color matrix metering, aperture value display, and balanced fill flash to be used with non-CPU lenses. See “Taking Photographs: Non-CPU Lenses” (128).

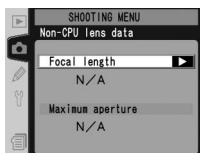

Custom settings are used to fine-tune a variety of camera settings to suit the user's preferences, creating combinations of settings that differ from the factory defaults in effect at the time your camera was purchased. In addition to Custom Settings C (**Bank select**) and R (**Menu reset**), settings in the CSM (Custom Settings) menu are divided into the following six groups:

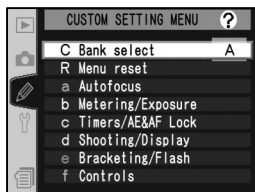

Group	Custom Settings
a <b>Autofocus</b>	a1–a8
b <b>Metering/Exposure</b>	b1–b7
c <b>Timers/AE&amp;AF Lock</b>	c1–c5
d <b>Shooting/Display</b>	d1–d6
e <b>Bracketing/Flash</b>	e1–e8
f <b>Controls</b>	f1–f7

Press the multi selector up or down to highlight the desired group and then press the multi selector to the right. The full list of Custom Settings a1–f7 will be displayed, starting with the settings in the selected group. To select a setting in a different group, press the multi selector up or down scroll until the desired setting is displayed, or press the multi selector to the left to return the top menu and select a different group. Custom Setting a1 (**AF-C mode priority**) and f7 (**No CF card?**) are linked: pressing the multi selector up when Custom Setting a1 is highlighted displays Custom Setting f7, while pressing the multi selector down while Custom Setting f7 is highlighted displays Custom Setting a1.

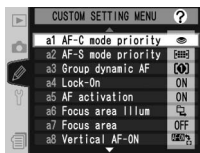

### Using the Multi Selector

The multi selector can be used at any time when the monitor is on. The focus selector lock switch only takes effect when the monitor is off.

The following Custom Settings are available:

Options			
C	Bank select	Custom setting bank	179
R	Menu reset	Reset CSM menu	180–181
a	<b>Autofocus</b>		
a1	AF-C mode priority	AF-C priority selection	182
a2	AF-S mode priority	AF-S priority selection	182
a3	Group dynamic AF	Pattern selection in Group Dynamic AF	183–184
a4	Lock-On	Focus Tracking with Lock-On	185
a5	AF activation	AF activation	185
a6	Focus area Illum	Focus area Illumination	186
a7	Focus area	Focus area select	187
a8	Vertical AF-ON	Vertical AF-ON button function	187
b	<b>Metering/Exposure</b>		
b1	ISO auto	ISO auto control	188
b2	ISO step value	ISO step value	189
b3	EV step	EV steps for exposure control	189
b4	Exposure comp. EV	EV steps for exposure compensation	189
b5	Exposure comp.	Easy exposure compensation	190
b6	Center weight	Center weight area	191
b7	Fine tune exposure	Fine tune optimal exposure	191
c	<b>Timers/AE&amp;AF Lock</b>		
c1	AE Lock	AE Lock buttons	192
c2	AE-L/AF-L	Assignment of AE-L/AF-L button	192
c3	Auto meter-off	Auto meter-off delay	193
c4	Self-timer	Self-timer delay	193
c5	Monitor off	Monitor off delay	193

Options			
<b>d</b>	<b>Shooting/Display</b>		
d1	Shooting speed	CL-Mode shooting speed	194
d2	Maximum shots	Max No. of shots taken in continuous shooting	194–195
d3	Exp. delay mode	Exposure delay mode	195
d4	File No. Seq.	File number sequence	196
d5	Cntrl panel/finder	Control panel/viewfinder display	196–197
d6	Illumination	LCD Illumination	197
<b>e</b>	<b>Bracketing/Flash</b>		
e1	Flash sync speed	Flash sync speed setting	198
e2	Flash shutter speed	Slowest speed when using flash	198
e3	AA flash mode	AA flash mode	199
e4	Modeling flash	Preview button activates modeling flash	199
e5	Auto BKT set	Auto bracketing set	200
e6	Manual mode bkting	Auto bracketing in M exposure mode	201
e7	Auto BKT Order	Auto bracketing order	201
e8	Auto BKT selection	Auto Bracketing Selection method	202
<b>f</b>	<b>Controls</b>		
f1	Center button	Multi selector center button	202–203
f2	Multi selector	When multi selector is pressed:	204
f3	PhotoInfo/Playback	Role of multi selector in Full-Frame Playback	204
f4	FUNC. button	Assign FUNC. Button	205
f5	Command dials	Customize command dials	206–207
f6	Buttons and dials	Setting method for buttons and dials	208
f7	No CF card?	Disable shutter if no CF card	208



## Custom Setting C: Custom Setting Bank

Custom Settings are stored in one of four banks. Changes to settings in one bank have no effect on the others. To store a particular combination of frequently-used settings, select one of the four banks and set the camera to these settings. The new settings will be stored in the bank even when the camera is turned off, and will be restored the next time the bank is selected. Different combinations of settings can be stored in the other banks, allowing the user to switch instantly from one combination to another by selecting the appropriate bank from the bank menu.

The default names for the four Custom Settings banks are A, B, C, and D. A descriptive caption can be added using the **Rename** option as described in “The Shooting Menu: Shooting Menu Bank” (167).

To display the bank menu, highlight **Bank select** in the top level of the CSM menu (176) and press the multi selector to the right. Press the multi selector up or down to highlight an option, then press to the right to make a selection.



Option	Description
<b>A*</b> (default)	Select bank A.
<b>B*</b>	Select bank B.
<b>C*</b>	Select bank C.
<b>D*</b>	Select bank D.
<b>Rename</b>	Rename selected bank.

\* Descriptive caption will also be displayed if bank has been renamed.

### Sensitivity (ISO Equivalency)

If a bank in which **On** is selected for Custom Setting b1 (**ISO auto**; 188) is chosen after ISO has been set to **HI-1** or **HI-2**, sensitivity (ISO equivalency) will not be adjusted automatically.

## Custom Setting R: Reset CSM Menu

To restore default settings for the current Custom Settings bank (179), highlight **Menu reset** in the top level of the CSM menu (176) and press the multi selector to the right. Press the multi selector up or down to highlight an option, then press to the right to make a selection.

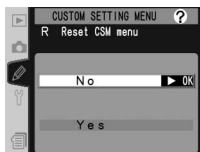

Option	Description
No	Exit menu, leaving settings unchanged.
Yes	Restore settings to default values.

### Two-Button Reset

Custom Settings are not reset when a two-button reset is performed (133).

### Custom Settings Bank

If settings in the current bank have been modified from default values, the rear control panel display will show **CUSTOM** and the letter of the bank. An asterisk will be displayed next to the altered settings in the second level of the Custom Settings menu.



Default settings are listed below.

Option	Default
a1 AF-C mode priority	FPS rate
a2 AF-S mode priority	Focus
a3 Group dynamic AF	Pattern 1/ Center area
a4 Lock-On	On
a5 AF activation	Shutter/AF-ON
a6 Focus area illum	
Manual focus mode	On
Continuous mode	On
When selected	0.2 s
a7 Focus area	No wrap
a8 Vertical AF-ON	AF-ON+Focus area
b1 ISO auto	Off
b2 ISO step value	1/3 step
b3 EV step	1/3 step
b4 Exposure comp. EV	1/3 step
b5 Exposure comp.	Off
b6 Center weight	φ 8 mm
b7 Fine tune exposure	0*
c1 AE Lock	AE-L/AF-L button
c2 AE-L/AF-L	AE/AF Lock
c3 Auto meter-off	6 s
c4 Self-timer	10 s
c5 Monitor off	20 s
d1 Shooting speed	3 fps
d2 Maximum shots	35

\* Applies to all metering methods.

Option	Default
d3 Exp. delay mode	Off
d4 File No. Seq.	Off
d5 Cntrl panel/finder	
Rear control panel	ISO
Viewfinder display	Frame count
d6 Illumination	Lamp on switch
e1 Flash sync speed	1/250
e2 Flash shutter speed	1/60
e3 AA flash mode	On
e4 Modeling flash	On
e5 Auto BKT set	AE & flash
e6 Manual mode bkting	Flash/speed
e7 Auto BKT order	MTR>Under>Over
e8 Auto BKT selection	Manual value select
f1 Center button	
Shooting mode	Center AF area
Playback mode	Thumbnail on/off
f2 Multi selector	Do nothing
f3 PhotoInfo/Playback	Info ◀▶/PB ▲▼
f4 FUNC. button	FV Lock
f5 Command dials	
Rotate direction	Normal
Change Main/Sub	Off
Aperture setting	Sub-command dial
Menus and Playback	Off
f6 Buttons and dials	Default
f7 No CF card?	On

## Custom Setting a1: AF-C Priority Selection

This option controls whether photographs can be taken whenever the shutter-release button is pressed (*release priority*) or only when the camera is in focus (*focus priority*) in continuous-servo AF. Highlight **a1 AF-C mode priority** in the second level of the CSM menu (177) and press the multi selector to the right. Press the multi selector up or down to highlight an option, then press to the right to make a selection.

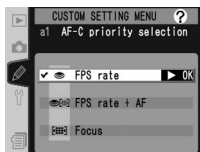

Option	Description
<b>FPS rate</b> (default)	Photos can be taken whenever shutter-release button is pressed.
<b>FPS rate + AF</b>	Photos can be taken even when camera is not in focus. In continuous mode, frame rate slows for improved focus if subject is dark or low contrast.
<b>Focus</b>	Photos can only be taken when in-focus indicator (●) is displayed.

## Custom Setting a2: AF-S Priority Selection

This option controls whether photographs can be taken only when the camera is in focus (*focus priority*) or whenever the shutter-release button is pressed (*release priority*) in single-servo AF. Highlight **a2 AF-S mode priority** in the second level of the CSM menu (177) and press the multi selector to the right. Press the multi selector up or down to highlight an option, then press to the right to make a selection.

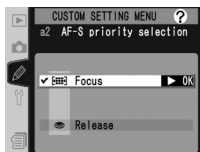

Option	Description
<b>Focus</b> (default)	Photos can only be taken when in-focus indicator (●) is displayed.
<b>Release</b>	Photos can be taken whenever shutter-release button is pressed.

### Custom Setting a3: *Pattern Selection in Group Dynamic AF*

This option controls how focus areas are grouped in group dynamic-AF (📷 77) and whether the camera gives priority to the subject in the center focus area of the selected group. Highlight **a3 Group dynamic AF** in the second level of the CSM menu (📷 177) and press the multi selector to the right. Press the multi selector up or down to highlight an option, then press to the right to make a selection.

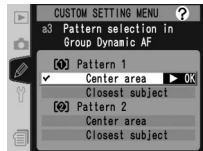

Option	Description
<b>Pattern 1/ Center area</b> (default)	Focus areas are grouped in pattern 1 (📷 184). Camera focuses on subject in center focus area of selected group. Because camera does not have to select focus area, less time is required for focus operation. If subject moves out of center focus area, camera will focus based on information from other focus areas in same group. Center focus area of selected group is highlighted in top control panel.
<b>Pattern 1/ Closest subject</b>	Focus areas are grouped in pattern 1 (📷 184). Camera automatically selects focus area containing subject closest to camera in current focus area group. If subject moves out of selected focus area, camera will focus based on information from other focus areas in same group.
<b>Pattern 2/ Center area</b>	As for <b>Pattern 1/Center area</b> , except that focus areas are grouped in pattern 2 (📷 184).
<b>Pattern 2/ Closest subject</b>	As for <b>Pattern 1/Closest subject</b> , except that focus areas are grouped in pattern 2 (📷 184).

Focus areas are grouped as follows (illustrations show the display in the top control panel):

	Pattern 1	Pattern 2*
Center area	<p>Top</p> <p>Left† Center Right†</p> <p>Bottom</p>	<p>Top</p> <p>Left† Center1 Center2 Right†</p> <p>Bottom</p>
Closest subject	<p>Top</p> <p>Left† Center Right†</p> <p>Bottom</p>	<p>Top</p> <p>Left† Center1 Center2 Right†</p> <p>Bottom</p>

\* The center focus-area group is selected by pressing the center of the multi selector once to activate the current center focus-area group and then pressing the center of the multi selector to toggle between "center 1" and "center 2." "Center 2" is only available when **Center AF area** (the default option) is selected for **Center button** (Custom Setting f1) > **Shooting mode**.

† The focus areas outside the high-speed crop are not displayed when high-speed crop is on.

### Custom Setting a4: Focus Tracking with Lock-On

This option controls how autofocus adjusts to sudden large changes in the distance to the subject. Highlight **a4 Lock-On** in the second level of the CSM menu (👁 177) and press the multi selector to the right. Press the multi selector up or down to highlight an option, then press to the right to make a selection.

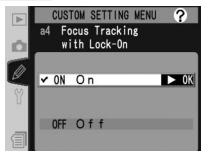

Option	Description
<b>On</b> (default)	Camera waits before adjusting focus when distance to subject changes abruptly. Prevents camera from refocusing when subject is briefly obscured by objects passing through frame.
<b>Off</b>	Camera immediately adjusts focus when distance to subject changes abruptly. Use when photographing series of subjects at varying distances in quick succession.

### Custom Setting a5: AF Activation

This option controls whether both the shutter-release button and the **AF-ON** buttons can be used to initiate autofocus or whether autofocus is only initiated when one of the **AF-ON** buttons is pressed. Highlight **a5 AF activation** in the second level of the CSM menu (👁 177) and press the multi selector to the right. Press the multi selector up or down to highlight an option, then press to the right to make a selection.

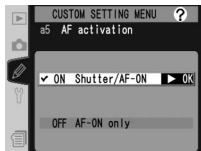

Option	Description
<b>Shutter/AF-ON</b> (default)	Autofocus can be performed with <b>AF-ON</b> buttons or by pressing shutter-release button halfway.
<b>AF-ON only</b>	Autofocus can only be performed using <b>AF-ON</b> buttons.

## Custom Setting a6: Focus Area Illumination

The options in this menu control when the focus areas are illuminated and for how long. Highlight **a6 Focus area illum** in the second level of the CSM menu (177) and press the multi selector to the right. Press the multi selector up or down to highlight an option, then press the multi selector to the right.

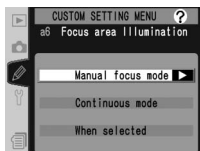

Option	Description
<b>Manual focus mode</b>	<p>Controls whether active focus area is displayed in manual focus mode. Press multi selector up or down to highlight option, press to right to select:</p> <ul style="list-style-type: none"> <li>• <b>On</b> (default): Active focus area displayed when shutter-release button is pressed halfway.</li> <li>• <b>Off</b>: Focus areas not displayed in manual focus mode.</li> </ul>
<b>Continuous mode</b>	<p>Controls whether active focus area is displayed in <b>CH</b> (continuous high-speed) or <b>CL</b> (continuous low-speed) mode. Press multi selector up or down to highlight option, press to right to select:</p> <ul style="list-style-type: none"> <li>• <b>On</b> (default): Active focus area displayed in continuous mode.</li> <li>• <b>Off</b>: Focus areas not displayed in continuous mode.</li> </ul>
<b>When selected</b>	<p>Determines how long active focus area is displayed when selected. Press multi selector up or down to highlight option, press to right to select:</p> <ul style="list-style-type: none"> <li>• <b>0.2s</b> (default): Active focus area displayed for 0.2s.</li> <li>• <b>1s</b>: Active focus area displayed for 1s.</li> </ul>

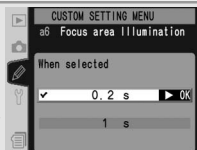
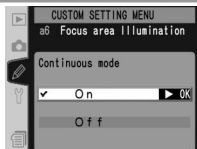
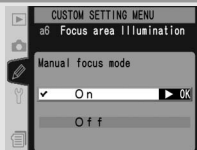



## Custom Setting a7: Focus Area Select

By default, the focus-area display is bounded by the four outer focus areas so that, for example, pressing the multi selector up when the top focus area is selected has no effect. Focus-area selection can be changed to “wrap around.” Highlight **a7 Focus area** in the second level of the CSM menu

( 177) and press the multi selector to the right. Press the multi selector up or down to highlight an option, then press to the right to make a selection.

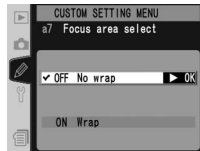

Option	Description
<b>No wrap</b> (default)	Wrap-around disabled.
<b>Wrap</b>	Focus-area selection “wraps around” from top to bottom, bottom to top, right to left, and left to right.

## Custom Setting a8: Vertical AF-ON Button Function

This option determines what functions are assigned to the **AF-ON** button for vertical shooting. Highlight **a8 Vertical AF-ON** in the second level of the CSM menu ( 177) and press the multi selector to the right. Press the multi selector up or down to highlight an option, then press to the right to make a selection.

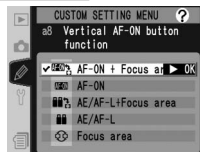

Option	Description
<b>AF-ON+ Focus area</b> (default)	Pressing vertical <b>AF-ON</b> button initiates autofocus. Focus area can be selected by pressing vertical <b>AF-ON</b> button and rotating sub-command dial.
<b>AF-ON</b>	Pressing vertical <b>AF-ON</b> button initiates autofocus.
<b>AE/AF-L+ Focus area</b>	As for <b>AF-ON+Focus area</b> , except that pressing vertical <b>AF-ON</b> button locks focus and exposure.
<b>AE/AF-L</b>	Pressing vertical <b>AF-ON</b> button locks focus and exposure.
<b>Focus area</b>	Focus area can be selected by pressing vertical <b>AF-ON</b> button and rotating sub-command dial. Button can not be used for other functions.

## Custom Setting b1: ISO Auto Control

If **On** is selected for this option, the camera will automatically adjust sensitivity (ISO equivalency) when necessary to help ensure optimal exposure. This option is not available at sensitivities of **HI-1** or **HI-2**.

Highlight **b1 ISO auto** in the second level of the CSM menu (177) and press the multi selector to the right. Press the multi selector up or down to highlight an option, then press to the right to make a selection.

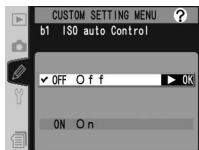

Option	Description
<b>Off</b> (default)	Sensitivity remains fixed at value selected by user, regardless of whether optimal exposure can be achieved at current exposure settings.
<b>On</b>	If optimal exposure can not be achieved at sensitivity selected by user, sensitivity is adjusted to compensate, to minimum approximately equivalent to ISO 100 and maximum approximately equivalent to ISO 800. Sensitivity can not be set to <b>HI-1</b> or <b>HI-2</b> while this option is in effect. Sensitivity remains fixed at value selected by user when flash is used.

When **On** is selected, the rear control-panel display shows **ISO-AUTO** and **ISO-A** appears in the viewfinder sidebar. These indicators flash when sensitivity is altered from the value selected by the user.

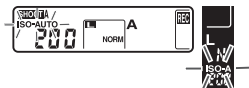

### Bank Select

If a shooting menu bank in which ISO has been set to **HI-1** or **HI-2** is chosen after **On** is selected for Custom Setting b1, sensitivity (ISO equivalency) will not be adjusted automatically. Sensitivity will also not be adjusted automatically if a Custom Settings bank in which **On** is selected for Custom Setting b1 is chosen after ISO has been set to **HI-1** or **HI-2**.

### High ISO NR (173)

Noise is more likely to appear in photographs taken at higher sensitivities. To reduce noise at sensitivities of ISO 400 equivalent and above, turn on the **High ISO NR** option in the shooting menu.

### Custom Setting b2: ISO Step Value

This option determines whether adjustments to sensitivity (ISO equivalency) are made in increments equivalent to  $\frac{1}{3}$ EV (**1/3 step**, the default option),  $\frac{1}{2}$ EV (**1/2 step**), or 1 EV (**1 step**). Highlight **b2 ISO step value** in the second level of the CSM menu (📷 177) and press the multi selector to the right. Press the multi selector up or down to highlight an option, then press to the right to make a selection.

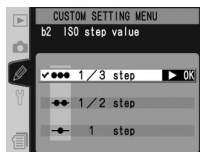

### Custom Setting b3: EV Steps for Exposure Control

This option determines whether adjustments to shutter speed, aperture, and bracketing are made in increments equivalent to  $\frac{1}{3}$ EV (**1/3 step**, the default option),  $\frac{1}{2}$ EV (**1/2 step**), or 1 EV (**1 step**). Highlight **b3 EV step** in the second level of the CSM menu (📷 177) and press the multi selector to the right. Press the multi selector up or down to highlight an option, then press to the right to make a selection.

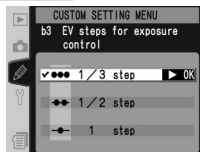

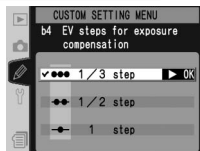

### Custom Setting b4: EV Steps for Exposure Compensation

This option determines whether adjustments to exposure compensation are made in increments equivalent to  $\frac{1}{3}$ EV (**1/3 step**, the default option),  $\frac{1}{2}$ EV (**1/2 step**), or 1 EV (**1 step**). Highlight **b4 Exposure comp. EV** in the second level of the CSM menu (📷 177) and press the multi selector to the right. Press the multi selector up or down to highlight an option, then press to the right to make a selection.



## Custom Setting b5: Easy Exposure Compensation

This option controls whether the  button is needed to set exposure compensation ( 97). If **On** is selected, the 0 at the center of the exposure display will blink even when exposure compensation is set to  $\pm 0$ .

Highlight **b5 Exposure comp.** in the second level of the CSM menu ( 177) and press the multi selector to the right. Press the multi selector up or down to highlight an option, then press to the right to make a selection.

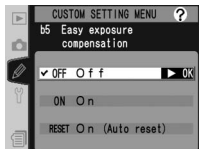

Option	Description			
<b>Off</b> (default)	Exposure compensation set by pressing  button and rotating main command dial.			
<b>On</b>	Exposure compensation set by rotating command dial only. Dial used depends on option selected for Custom Setting f5 > <b>Change Main/Sub</b> .			
	<b>Command dials (Custom Setting f5) &gt; Change Main/Sub</b>			
		<b>Off</b>	<b>On</b>	
	Exposure mode	P	Sub-command dial	Sub-command dial
		S	Sub-command dial	Main command dial
A		Main command dial	Sub-command dial	
M	N/A			

## Custom Setting b6: Center Weight Area

When calculating exposure, center-weighted metering assigns the greatest weight to a circle in the center of the frame. The diameter ( $\phi$ ) of this circle can be selected from 6, 8, 10, and 13mm (the default option is 8mm; note that the diameter is fixed at 8mm when a non-CPU lens is used, regardless of the setting selected for **Non-CPU lens data** in the shooting menu). Highlight **b6 Center weight** in the second level of the CSM menu (🔍 177) and press the multi selector to the right. Press the multi selector up or down to highlight an option, then press to the right to make a selection.

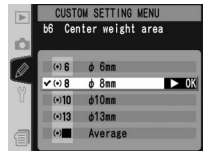

## Custom Setting b7: Fine Tune Optimal Exposure

Use this option to fine-tune the exposure value selected by the camera. Exposure can be fine-tuned separately for each metering method by from +1 to -1 EV in steps of  $\frac{1}{6}$ EV. Highlight **b7 Fine tune exposure** in the second level of the CSM menu (🔍 177) and press the multi selector to the right. A message will be displayed warning that the  icon does not appear when exposure is altered; press the multi selector up or down to highlight **Yes** and press the multi selector to the right (select **No** to exit without altering exposure). Press the multi selector up or down to highlight a metering method and press the multi selector to the right to display a list of exposure values. Press the multi selector up or down to highlight an option, then press to the right to make a selection.

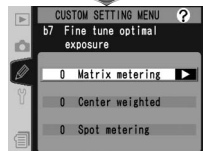
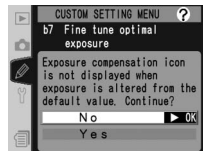

### Fine-Tuning Exposure

Exposure can be fine-tuned separately for each Custom Settings bank. Note that as the exposure compensation icon () is not displayed, the only way to determine whether exposure has been altered is to view the fine-tuning menu. Exposure compensation (🔍 97) is recommended in most situations.

## Custom Setting c1: AE Lock Buttons

This option determines what controls lock exposure. Highlight **c1 AE Lock** in the second level of the CSM menu (177) and press the multi selector to the right. Press the multi selector up or down to highlight an option, then press to the right to make a selection.

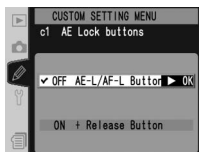

Option	Description
<b>AE-L/AF-L Button</b> (default)	Exposure can only be locked by pressing <b>AE-L/AF-L</b> button.
<b>+Release Button</b>	Exposure can be locked by pressing <b>AE-L/AF-L</b> button or by pressing shutter-release button halfway.

## Custom Setting c2: Assignment of AE-L/AF-L Button

This option controls the behavior of the **AE-L/AF-L** button. Highlight **c2 AE-L/AF-L** in the second level of the CSM menu (177) and press the multi selector to the right. Press the multi selector up or down to highlight an option, then press to the right to make a selection.

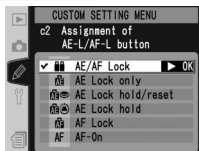

Option	Description
<b>AE/AF Lock</b> (default)	Both focus and exposure lock while <b>AE-L/AF-L</b> button is pressed.
<b>AE Lock only</b>	Exposure locks while <b>AE-L/AF-L</b> button is pressed. Focus is unaffected.
<b>AE Lock hold/reset</b>	Exposure locks when <b>AE-L/AF-L</b> button is pressed and remains locked until button is pressed again, shutter is released or exposure meters turn off.
<b>AE Lock hold</b>	Exposure locks when <b>AE-L/AF-L</b> button is pressed and remains locked until button is pressed again or exposure meters turn off.
<b>AF Lock</b>	Focus locks while <b>AE-L/AF-L</b> button is pressed. Exposure is unaffected.
<b>AF-On</b>	<b>AE-L/AF-L</b> button performs same function as <b>AF-ON</b> button.

### Custom Setting c3: Auto Meter-off Delay

This option controls how long the camera continues to meter exposure when no operations are performed: 4s, 6s (the default option), 8s, or 16s or until the camera is turned off (**No limit**). Highlight **c3 Auto meter-off** in the second level of the CSM menu (177) and press the multi selector to the right. Press the multi selector up or down to highlight an option, then press to the right to make a selection. Choose a shorter meter-off delay for longer battery life.

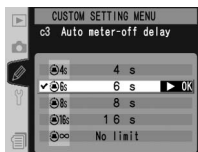

### Custom Setting c4: Self-Timer Delay

This option controls the length of the shutter-release delay in self-timer mode. Shutter-release can be delayed by approximately 2s, 5s, 10s (the default option), or 20s. Highlight **c4 Self-timer** in the second level of the CSM menu (177) and press the multi selector to the right. Press the multi selector up or down to highlight an option, then press to the right to make a selection.

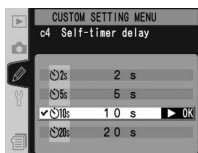

### Custom Setting c5: Monitor off Delay

This option controls how long the monitor remains on when no operations are performed: 10s, 20s (the default option), 1 minute, 5 minutes, or 10 minutes. Highlight **c5 Monitor off** in the second level of the CSM menu (177) and press the multi selector to the right. Press the multi selector up or down to highlight an option, then press to the right to make a selection. Choose a shorter monitor-off delay for longer battery life.

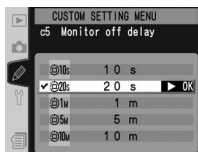

### The EH-6 AC Adapter

When the camera is powered by an optional EH-6 AC adapter, exposure meters will not turn off and the monitor will only power off after ten minutes, regardless of the options chosen for Custom Settings c3 (**Auto meter-off**) and c5 (**Monitor off**).

## Custom Setting d1: CL-Mode Shooting Speed

This option determines the rate at which photographs can be taken in CL (continuous low-speed) mode (during interval timer photography, this setting also determines the frame advance rate for single-frame and mirror-up modes). Shooting speed can be set to values between 1 and 7 frames per second (fps); the default value is 3 fps. Regardless of the setting chosen, the maximum speed when **Hi-speed Crop** is **Off** is 4 fps (41). The frame advance rate may drop at slow shutter speeds.

Highlight **d1 Shooting speed** in the second level of the CSM menu (178) and press the multi selector to the right. Press the multi selector up or down to highlight an option, then press to the right to make a selection.

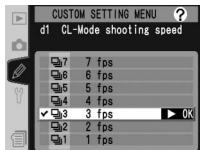

## Custom Setting d2: Max No. of shots taken in continuous shooting

The maximum number of shots that can be taken in a single burst in continuous mode can be set to any value between 1 and 35. Regardless of the setting chosen, the maximum number of shots that can be taken in a single burst can not exceed the following values:

Image quality	High-speed crop: Off	High-speed crop: On
Uncompressed NEF (RAW)+JPEG *	16	28
Compressed NEF (RAW)+JPEG *	16	28
Uncompressed NEF (RAW)	17	29
Compressed NEF (RAW)	17	29
TIFF (RGB)	16	28
JPEG *	22	35

\* Assumes **JPEG compression** is set to **Size priority**. When **Optimal quality** is selected, file size of JPEG images increases by up to about eighty percent and number of images that can be taken in one burst drops accordingly.



Highlight **d2 Maximum shots** in the second level of the CSM menu (🔍 178) and press the multi selector to the right. Press the multi selector up or down to choose the number of shots, then press to the right to make a selection.

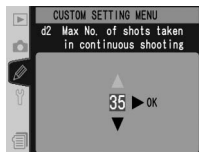

### Custom Setting d3: *Exposure Delay Mode*

Shutter release can be delayed until about 0.4s after the shutter-release button is pressed, reducing camera shake in situations in which the least camera movement could result in blurred photographs (for example, microscope photography). Highlight **d3 Exp. delay mode** in the second level of the CSM menu (🔍 178) and press the multi selector to the right. Press the multi selector up or down to highlight an option, then press to the right to make a selection.

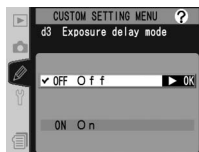

Option	Description
<b>Off</b> (default)	Shutter is released when shutter-release button is pressed.
<b>On</b>	Shutter is released about 0.4s after shutter-release button is pressed.

## Custom Setting d4: File Number Sequence

When a photograph is taken, the camera names the file new by adding one to the last file number used. This option controls whether file numbering continues from the last number used when a new folder is created, the memory card is formatted, or a new memory card is inserted in the camera.

Highlight **d4 File No. Seq.** in the second level of the CSM menu (178) and press the multi selector to the right. Press the multi selector up or down to highlight an option, then press to the right to make a selection.

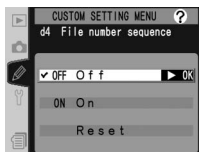



Option	Description
<b>Off</b> (default)	File numbering reset to 0001 when new folder is created, memory card is formatted or new memory card is inserted in camera.
<b>On</b>	When new folder is created, memory card is formatted, or new memory card inserted in camera, file numbering continues from last number used or from largest number in current folder, whichever is higher. If photograph is taken when current folder contains photograph numbered 9999, new folder will be created automatically and file numbering will begin again from 0001.
<b>Reset</b>	As for <b>On</b> , except that next photograph taken is assigned file number by adding one to largest file number in current folder. If selected folder contains no photographs, file numbering reset to 0001.

## Custom Setting d5: Control Panel/Viewfinder Display

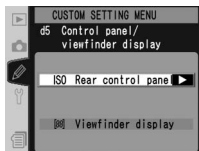
The options in this menu control the information displayed in the viewfinder and rear control panel. Highlight **d5 Cntrl panel/finder** in the second level of the CSM menu (178) and press the multi selector to the right. Press the multi selector up or down to highlight an option, then press the multi selector to the right.



Option	Description
<b>Rear control panel</b>	Controls whether rear control panel shows sensitivity (ISO equivalency) or number of exposures remaining. Press multi selector up or down to highlight option, press to right to select: <ul style="list-style-type: none"> <li>• <b>ISO</b> (default): Rear panel shows sensitivity.</li> <li>• <b>Exposures remaining</b>: Rear panel shows number of exposures remaining. Sensitivity displayed only while <b>ISO</b> button is pressed.</li> </ul> 
<b>Viewfinder display</b>	Controls whether viewfinder shows frame count or number of exposures remaining (note that regardless of option selected, number of frames that can be stored in memory buffer will be shown while shutter-release button is pressed). Press multi selector up or down to highlight option, press to right to select: <ul style="list-style-type: none"> <li>• <b>Frame count</b> (default): Viewfinder shows frame count.</li> <li>• <b>Exposures remaining</b>: Viewfinder shows number of exposures remaining.</li> </ul> 

### Custom Setting d6: LCD Illumination

This option controls the control panel backlights (LCD illuminators). Highlight **d6 Illumination** in the second level of the CSM menu (178) and press the multi selector to the right. Press the multi selector up or down to highlight an option, then press to the right to make a selection.



Option	Description
<b>Lamp on switch</b> (default)	Control panels illuminate only while power switch is rotated to  position.
<b>Any button</b>	Control panels illuminate whenever exposure meters are active (note that this increases drain on battery).

## Custom Setting e1: Flash Sync Speed Setting

This option controls flash sync speed. Options range from  $\frac{1}{250}$ s (**1/250**, the default setting) and  $\frac{1}{60}$ s (**1/60**). To enable auto FP high-speed sync when using an SB-800 or SB-600 Speedlight, select **1/250 (Auto FP)** (if an SB-800 or SB-600 is not attached when this option is selected, flash sync speed will be set to  $\frac{1}{250}$ s). When the camera shows a shutter speed of  $\frac{1}{250}$ s in exposure mode **P** or **A**, Auto FP High-Speed Sync will be activated if the actual shutter speed is faster than  $\frac{1}{250}$ s.

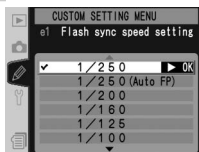

Highlight **e1 Flash sync speed** in the second level of the CSM menu (178) and press the multi selector to the right. Press the multi selector up or down to highlight an option, then press to the right to make a selection.

## Custom Setting e2: Slowest Speed When Using Flash

This option determines the slowest shutter speed possible when using front- or rear-curtain sync or red-eye reduction in programmed auto or aperture-priority auto exposure mode (regardless of the setting chosen, shutter speeds can be as slow as 30s in shutter-priority auto and manual exposure modes or when the flash is set to slow sync, slow rear-curtain sync, or red-eye reduction with slow sync). Options range from  $\frac{1}{60}$ s (**1/60**, the default setting) and 30s (**30"**).

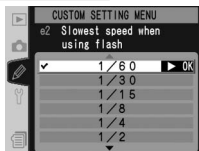

Highlight **e2 Flash shutter speed** in the second level of the CSM menu (178) and press the multi selector to the right. Press the multi selector up or down to highlight an option, then press to the right to make a selection.

## Fixing Shutter Speed at the Flash Sync Speed Limit

To fix shutter speed at the sync speed limit in shutter-priority auto or manual exposure modes, select the shutter speed after the slowest possible shutter speed (30s or **30" & b**). An X will be displayed in the flash sync indicator in the top control panel.

### Custom Setting e3: AA Flash Mode

This option controls whether flash level is automatically adjusted for aperture when an external exposure meter is used with an SB-80DX or SB-28DX Speedlight (in the case of the SB-800, the flash mode chosen with the Speedlight is used regardless of the option chosen for Custom Setting e3). Highlight **e3 AA flash mode** in the second level of the CSM menu (📷 178) and press the multi selector to the right. Press the multi selector up or down to highlight an option, then press to the right to make a selection.

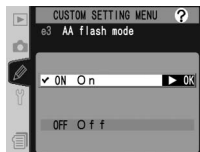

Option	Description
<b>On</b> (default)	Flash level automatically adjusted for aperture when external exposure meter is used with SB-80DX or SB-28DX Speedlight (auto aperture).*
<b>Off</b>	Aperture specified manually using Speedlight controls (non-TTL auto).

\* To use auto aperture with non-CPU lenses, specify maximum aperture of lens using **Non-CPU lens data** option in shooting menu.

### Custom Setting e4: Preview Button Activates Modeling Flash

This option determines whether the SB-800 and SB-600 emit a modeling flash when the depth-of-field preview button is pressed. Highlight **e4 Modeling flash** in the second level of the CSM menu (📷 178) and press the multi selector to the right. Press the multi selector up or down to highlight an option, then press to the right to make a selection.

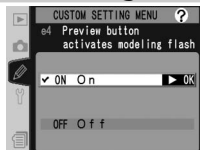

Option	Description
<b>On</b> (default)	Modeling flash is emitted when depth-of-field is previewed (📷 85).
<b>Off</b>	No modeling flash emitted when depth-of-field preview button is pressed.

## Custom Setting e5: Auto Bracketing Set

This option controls what settings are affected when auto bracketing is in effect. Highlight **e5 Auto BKT set** in the second level of the CSM menu (178) and press the multi selector to the right. Press the multi selector up or down to highlight an option, then press to the right to make a selection.

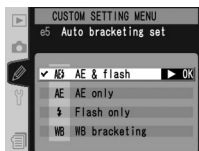

Option	Description
<b>AE &amp; flash</b> (default)	Camera performs exposure and flash-level bracketing.
<b>AE only</b>	Camera performs exposure bracketing only.
<b>Flash only</b>	Camera performs flash-level bracketing only.
<b>WB bracketing</b>	Camera performs white balance bracketing.

### White Balance Bracketing

White balance bracketing is not available at image quality settings of NEF (RAW) or NEF+JPEG.

## Custom Setting e6: Auto Bracketing in M Exposure Mode

This option controls what settings are affected when **AE & flash** or **AE only** is selected for Custom Setting e5 in manual exposure mode. Highlight **e6 Manual mode bkting** in the second level of the CSM menu (🔍 178) and press the multi selector to the right. Press the multi selector up or down to highlight an option, then press to the right to make a selection.

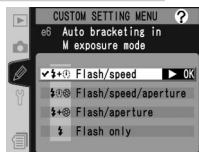

Option	Description
<b>Flash/speed</b> (default)	Camera varies shutter speed (Custom Setting e5 set to <b>AE only</b> ) or shutter speed and flash level (Custom Setting e5 set to <b>AE &amp; flash</b> ).
<b>Flash/speed/aperture</b>	Camera varies shutter speed and aperture (Custom Setting e5 set to <b>AE only</b> ) or shutter speed, aperture, and flash level (Custom Setting e5 set to <b>AE &amp; flash</b> ).
<b>Flash/aperture</b>	Camera varies aperture (Custom Setting e5 set to <b>AE only</b> ) or aperture and flash level (Custom Setting e5 set to <b>AE &amp; flash</b> ).
<b>Flash only</b>	Camera varies flash level only (Custom Setting e5 set to <b>AE &amp; flash</b> ).

- If no flash is attached when Custom Setting b1 (**ISO auto**) is on, camera will vary sensitivity only, regardless of setting selected.
- Flash bracketing performed only with i-TTL, D-TTL, or AA flash control.

## Custom Setting e7: Auto Bracketing Order

This option controls the order in which bracketing is performed. Highlight **e7 Auto BKT Order** in the second level of the CSM menu (🔍 178) and press the multi selector to the right. Press the multi selector up or down to highlight an option, then press to the right to make a selection.

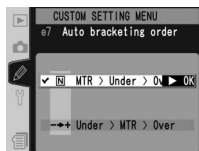

Option	Description
<b>MTR&gt;Under&gt;Over</b> (default)	Bracketing performed in order described in “Bracketing” (🔍 98).
<b>Under&gt;MTR&gt;Over</b>	Bracketing proceeds in order from lowest to highest value.

## Custom Setting e8: Auto Bracketing Selection Method

This option controls how the bracketing program is selected. Highlight **e8 Auto BKT selection** in the second level of the CSM menu (178) and press the multi selector to the right. Press the multi selector up or down to highlight an option, then press to the right to make a selection.

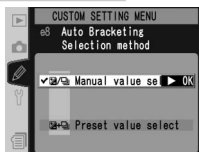

Option	Description
<b>Manual value select</b> (default)	Pressing <b>BKT</b> button, rotate main command dial to select number of shots, sub-command dial to select bracketing increment.
<b>Preset value select</b>	Press <b>BKT</b> button and rotate main command dial to turn bracketing on and off. Press <b>BKT</b> button and rotate sub-command dial to select number of shots and bracketing increment.

## Custom Setting f1: Multi Selector Center Button

This option determines what operations can be performed by pressing the center of the multi selector. Highlight **f1 Center button** in the second level of the CSM menu (178) and press the multi selector to the right. Press the multi selector up or down to highlight an option, then press the multi selector to the right.



### Shooting Mode

This option controls what operation can be performed by pressing the center of the multi selector when the camera is in shooting mode.

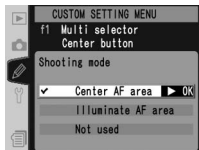

### Using the Multi Selector

The multi selector can be used at any time when the monitor is on. The focus selector lock switch only takes effect when the monitor is off.



Press the multi selector up or down to highlight an option, then press to the right to make a selection.

Option	Description
<b>Center AF area</b> (default)	Pressing center of multi selector selects center focus area or center focus-area group (group dynamic-AF). If <b>Pattern 2</b> is selected for Custom Setting a3 ( <b>Group dynamic AF</b> ), center of multi selector can be used to toggle between center focus area groups.
<b>Illuminate AF area</b>	Pressing center of multi selector illuminates active focus area or focus-area group (group dynamic-AF) in viewfinder.*
<b>Not used</b>	Pressing center of multi selector has no effect when camera is in shooting mode.*

\* Center of multi selector can not be used to toggle between center focus-area groups when **Pattern 2** is selected for Custom Setting a3 (**Group dynamic AF**).

### Playback Mode

This option controls what operation is performed when the center of the multi selector is pressed in playback mode. Press the multi selector up or down to highlight an option, then press to the right to make a selection.

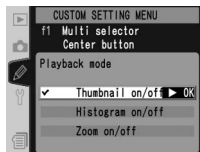

Option	Description
<b>Thumbnail on/off</b> (default)	Press center of multi selector to toggle between single-image and thumbnail playback.
<b>Histogram on/off</b>	Press center of multi selector to turn histogram display on and off.
<b>Zoom on/off</b>	Press center of multi selector to zoom in on image, press again to return to full-frame display or thumbnail playback. When this option is selected, menu of zoom settings shown at right is displayed. Choose from <b>Low magnification</b> , <b>Medium magnification</b> , and <b>High magnification</b> .

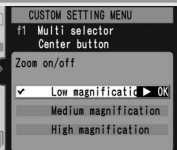

## Custom Setting f2: When Multi Selector Is Pressed

If desired, the multi selector can be used to activate the exposure meters or initiate autofocus. Highlight **f2 Multi selector** in the second level of the CSM menu (178) and press the multi selector to the right. Press the multi selector up or down to highlight an option, then press to the right to make a selection.

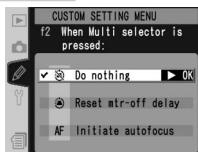

Option	Description
<b>Do nothing</b> (default)	Multi selector does not activate exposure meters or initiate autofocus.
<b>Reset mtr-off delay</b>	Pressing multi selector activates exposure meters.
<b>Initiate autofocus</b>	In AF-S or AF-C mode, pressing multi selector activates exposure meters. Camera focuses while multi selector is pressed.

## Custom Setting f3: Role of Multi Selector in Full-Frame Playback

By default, pressing the multi selector up or down during playback displays the other images on the memory card, while pressing the multi selector left or right changes the photo information displayed. These roles can be reversed using Custom Setting f3. Highlight **f3 PhotoInfo/Playback** in the second level of the CSM menu (178) and press the multi selector to the right. Press the multi selector up or down to highlight an option, then press to the right to make a selection.

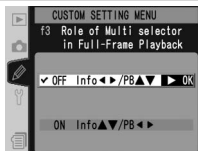

Option	Description
<b>Info ◀▶/PB▲▼</b> (default)	Press multi selector up or down to display additional images, left or right to change photo info displayed.
<b>Info ▲▼/PB▶◀</b>	Press multi selector up or down to change photo info displayed, left or right to display additional images.

## Custom Setting f4: Assign FUNC. Button

This option controls the function performed by the FUNC. button. Highlight **f4 FUNC. Button** in the second level of the CSM menu (📷 178) and press the multi selector to the right. Press the multi selector up or down to highlight an option, then press to the right to make a selection.

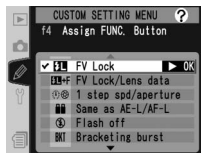

Option	Description
<b>FV Lock</b> (default)	If SB-800 or SB-600 Speedlight is attached, flash value locks when FUNC. button is pressed. Press again to cancel FV lock.
<b>FV Lock/ Lens data</b>	As above, except that when SB-800 or SB-600 is off or not attached, FUNC. button and command dials can be used to specify focal length and aperture of non-CPU lenses (📷 128).
<b>1 step spd/ aperture</b>	If FUNC. button is pressed when rotating command dials, changes to shutter speed (exposure modes S and M) and aperture (exposure modes A and M) are made in increments of 1 EV.
<b>Same as AE-L/AF-L</b>	FUNC. button performs same functions as <b>AE-L/AF-L</b> button.
<b>Flash off</b>	Flash will not fire in photos taken while FUNC. button is pressed.
<b>Bracketing burst</b>	While FUNC. button is pressed, all shots in exposure or flash bracketing program will be taken each time shutter-release button is pressed. In continuous high-speed and continuous low-speed modes, camera will repeat bracketing burst while shutter-release button is held down. If white-balance bracketing is selected, camera will take photos at up to 8 fps (single or continuous high-speed mode) or 1–7 fps (continuous low-speed mode) and perform white balance bracketing on each frame.
<b>Matrix metering</b>	Matrix metering activated while FUNC. button is pressed.
<b>Center-weighted</b>	Center-weighted metering activated while FUNC. button is pressed.
<b>Spot metering</b>	Spot metering activated while FUNC. button is pressed.
<b>Hi-speed Crop</b>	FUNC. button and main command dial can be used to turn high-speed crop mode on and off (📷 41). Hi-speed crop mode can not be changed after first shot in multiple exposure.

## Custom Setting f5: *Customize Command Dials*

This option controls the operation of the main and sub-command dials. Highlight **f5 Command dials** in the second level of the CSM menu (178) and press the multi selector to the right. Press the multi selector up or down to highlight an option, then press the multi selector to the right.

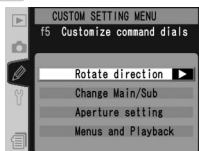

Option	Description
<b>Rotate direction</b>	<p>Controls direction of command dials when setting flexible program, shutter speed, easy exposure compensation, exposure mode, exposure compensation value, bracketing increment, and flash sync mode. Press multi selector up or down to highlight option, press to right to select:</p> <ul style="list-style-type: none"> <li>• <b>Normal</b> (default): Normal command dial operation.</li> <li>• <b>Reverse</b>: Reverses rotation of command dials.</li> </ul>
<b>Change Main/Sub</b>	<p>Exchanges functions of main and sub-command dials when setting shutter speed and aperture. Press multi selector up or down to highlight option, press to right to select:</p> <ul style="list-style-type: none"> <li>• <b>Off</b> (default): Main command dial controls shutter speed, sub-command dial controls aperture.</li> <li>• <b>On</b>: Main command dial controls aperture, sub-command dial controls shutter speed.</li> </ul>
<b>Aperture setting</b>	<p>Controls whether changes to aperture are made using lens aperture ring or command dials. Regardless of setting chosen, lens ring must be used to set aperture for non-CPU lenses, command dials to set aperture for type G lenses not equipped with aperture ring. Press multi selector up or down to highlight option, press to right to select:</p> <ul style="list-style-type: none"> <li>• <b>Sub-command dial</b> (default): Aperture can only be adjusted with sub-command dial (or main command dial if <b>Change Main/Sub</b> is <b>On</b>).</li> <li>• <b>Aperture ring</b>: Aperture can only be adjusted using lens aperture ring. Camera aperture display shows aperture in increments of 1 EV. This option is selected automatically when non-CPU lens is attached.</li> </ul>

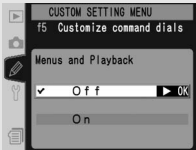
Option	Description
<b>Menus and Playback</b>	<p>Controls functions performed by command dials during playback or when menus are displayed. Press multi selector up or down to highlight option, press to right to select:</p> <ul style="list-style-type: none"> <li>• <b>Off</b> (default): Multi selector used to choose picture displayed, highlight thumbnails, and navigate menus.</li> <li>• <b>On</b>: Main command dial performs same function as pressing multi selector left or right. Sub-command dial performs same function as pressing multi selector up or down. Note that this option has no effect on the roles played by the command dials during playback zoom.</li> </ul> <p><b>Single-image playback:</b> main command dial is used to choose picture displayed, sub-command dial to display additional photo information.</p> <p><b>Thumbnail playback:</b> main command dial moves cursor left or right, sub-command dial moves cursor up or down.</p> <p><b>Menu navigation:</b> main command dial moves highlight bar up or down. Rotate sub-command dial to right to display sub-menu, to left to return to previous menu. To make selection, press multi selector to right, press center of multi selector, or press  button.</p> 

## Custom Setting f6: Setting Method for Buttons and Dials

This option allows adjustments that are normally made by holding a button and rotating a command dial to be made by rotating the command dial after the button is released. Highlight **f6 Buttons and dials** in the second level of the CSM menu (178) and press the multi selector to the right. Press the multi selector up or down to highlight an option, then press to the right to make a selection.



Option	Description
<b>Default</b> (default)	Changes to settings made by rotating command dial while button is held down.
<b>Hold</b>	Settings can be changed by rotating command dial after button is released. To exit, press button again, press shutter-release button halfway, press <b>MODE</b> , <b>ISO</b> , <b>QUAL</b> , or <b>WB</b> button, or (except when <b>No limit</b> is selected for Custom Setting c3 or optional adapter is used) wait for about 20s.

## Custom Setting f7: Disable Shutter If No CF Card

This option can be used to enable the shutter release when no memory card is inserted in the camera. Note that when photographs are being captured to a computer using Nikon Capture 4 Camera Control, photographs are not recorded to the camera memory card and the shutter release will be enabled regardless of the setting chosen for this option.

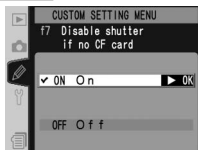

Highlight **f7 No CF card?** in the second level of the CSM menu (178) and press the multi selector to the right. Press the multi selector up or down to highlight an option, then press to the right to make a selection.

Option	Description
<b>On</b> (default)	Shutter-release button disabled when no memory card is inserted.
<b>Off</b>	Shutter-release button enabled even when no memory card is inserted.

The setup menu contains three pages of options:

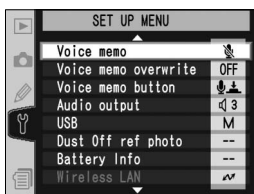

Option	
Format	210
LCD brightness	211
Mirror Lock-up*	211
Video mode	212
World Time	18
Language	17
Image comment	213
Auto image rotation	214
Voice memo	148
Voice memo overwrite	149
Voice memo button	149
Audio output	151
USB	216
Dust Off ref photo	217–218
Battery Info	219
Wireless LAN†	219–227
Firmware Version	227

\* Available only when optional EH-6 AC adapter is connected.

† Available only when optional WT-2/2A or WT-1/1A wireless transmitter is connected.

## Using the Multi Selector

The multi selector can be used at any time when the monitor is on. The focus selector lock switch only takes effect when the monitor is off.

## Format

Memory cards must be formatted before first use. Formatting memory cards is also an effective way of deleting all pictures on the card. To format a memory card, highlight **Format** in the setup menu (209) and press the multi selector to the right. Press the multi selector up or down to highlight one of the following options and then press the **ENTER** button:

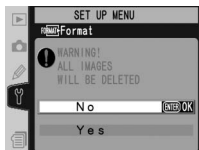

Option	Description
No	Exit without formatting memory card.
Yes	Format memory card. Message shown at right displayed while formatting is in progress. <i>Do not turn the camera off, remove the batteries or memory card, or unplug the AC adapter (available separately) until formatting is complete and setup menu is displayed.</i>



### ✓ During Formatting

*Do not remove the memory card, remove the battery, or unplug the AC adapter (available separately) while formatting is in progress.*

### ✍ Before Formatting

*Formatting memory cards permanently deletes all data they contain, including hidden and protected pictures and any other data that may be on the card.* Before formatting, be sure to transfer to a computer any pictures you would like to keep.

### ✍ FAT 32

The D2X supports FAT 32, allowing use of memory cards with capacities of over 2 GB. FAT 16 is used when reformatting cards already formatted in FAT 16.

### 🔍 Two-Button Format

Memory cards can also be formatted with the **FORMAT**, **MODE** and **DISK** buttons (23).



## LCD Brightness

To adjust monitor brightness, highlight **LCD brightness** in the setup menu (📷 209) and press the multi selector to the right. The menu shown at right will be displayed. Press the multi selector up to increase brightness, down to decrease. The number to the right of the display indicates the current brightness level, with +2 the brightest setting and -2 the darkest. Press the multi selector to the right to complete the operation and return to the setup menu.



## Mirror Lock-up

This option is used to lock the mirror in the up position to allow inspection or cleaning of the low-pass filter that protects the image sensor. See “Technical Notes: Caring for the Camera” (📷 252). When an optional EH-6 AC adapter is connected, **Mirror Lock-up** will be available in the setup menu (📷 209). Highlighting this option and pressing the multi selector to the right displays the menu shown above. If the multi selector is pressed to the right again, a row of dashes (“---- --”) will be displayed in the top control panel. To raise the mirror, press the shutter-release button. The mirror will be locked in the up position the row of dashes will blink. The mirror will be lowered when the camera is turned off.



## Video Mode

Before connecting your camera to a video device such as a television or VCR (📺 230), choose a video mode setting that matches the video standard used in the device. Highlight **Video mode** in the setup menu (📺 209) and press the multi selector to the right. Press the multi selector up or down to highlight an option, then press to the right to make a selection.

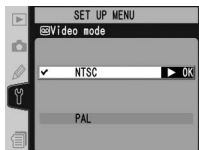

Option	Description
<b>NTSC</b>	Use when connecting camera to NTSC devices.
<b>PAL</b>	Use when connecting camera to PAL devices. Note that number of pixels in output is selectively reduced, causing drop in resolution.

## World Time

**World Time** is used to set the camera clock to the current date and time. See “First Steps: Step 3—Basic setup” (📺 17).



## Language

Choose the language for camera menus and messages from 中文(简体) (Chinese), **Deutsch** (German), **English**, **Español** (Spanish), **Français** (French), 한글 (Korean), **Italiano** (Italian), 日本語 (Japanese), **Nederlands** (Dutch), and **Svenska** (Swedish). See “First Steps: Step 3—Basic setup” (📺 18).



### Video Mode

The default video standard varies with the country or region of purchase.

## Image Comment

Using this option, brief texts comment can be added to photographs as they are taken. Comments can be viewed when the photographs are displayed using PictureProject or Nikon Capture 4 version 4.2 or later. The first twelve letters of the comment are also visible on the fourth page of the photo information display (📷 138).

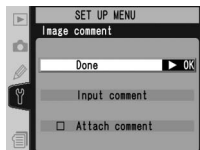

Highlight **Image comment** in the setup menu (📷 209) and press the multi selector to the right. Press the multi selector up or down to highlight an option, then press to the right to make a selection.

**Done:** Save changes and return to the setup menu.

**Input comment:** The following dialog will be displayed. Enter a comment as described below.

Keyboard area

Use multi selector to highlight letters, press center of multi selector to select.



Comment area

Comment appears here. To move cursor, press 📷 button and use multi selector.

To move the cursor in the comment area, press the 📷 button and use the multi selector. To enter a new letter at the current cursor position, use the multi selector to highlight the desired character in the keyboard area and press the center of the multi selector. To delete the character at the current cursor position, press the 🗑️ button. To return to the setup menu without changing the comment, press the 📄 button.

Comments can be up to thirty-six characters long. Any characters after the thirty-sixth will be deleted.

After editing the comment, press 📄 to return to the image comment menu.



**Attach comment:** A comment is added to all photographs taken when this option is checked (✓). Highlight this option and press the multi selector to the right to toggle the check mark on or off.

## Auto Image Rotation

The D2X is equipped with a built-in sensor that detects camera orientation. Information from this sensor can be embedded in photographs as they are taken, allowing portrait (tall) orientation photos to be rotated automatically during playback or when the pictures are displayed in PictureProject or Nikon Capture 4 version 4.2 or later (available separately).

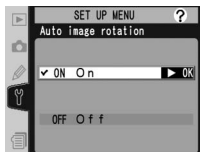
Highlight **Auto image rotation** in the setup menu (209) and press the multi selector to the right. Press the multi selector up or down to highlight an option, then press to the right to make a selection.



Option	Description
<b>On</b> (default)	Camera records whether shots are in landscape (wide) orientation, portrait (tall) orientation with the camera rotated 90° clockwise, or portrait orientation with the camera rotated 90° counter-clockwise.* If <b>On</b> is selected for <b>Rotate tall</b> during playback (165), portrait orientation photos will be displayed in portrait orientation in camera monitor. <div style="display: flex; justify-content: space-around; align-items: center; margin-top: 10px;"> <div style="text-align: center;">               Landscape (wide) orientation           </div> <div style="text-align: center;">               Camera rotated 90° clockwise           </div> <div style="text-align: center;">               Camera rotated 90° counter-clockwise           </div> </div>
<b>Off</b>	Camera orientation not recorded. PictureProject and Nikon Capture 4 version 4.2 or later display all photographs in landscape (wide) orientation. Choose this option when taking pictures with lens pointing up or down.

\* In CH (continuous high speed) and CL (continuous low speed) modes (43), orientation recorded for first shot applies to all images in same burst, even if camera orientation is changed during shooting.

## Voice Memo

**Voice memo** contains options for recording voice memos in shooting mode. See “Voice Memos” (148).

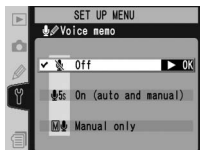

## Voice Memo Overwrite

The option selected for **Voice memo overwrite** determines whether the voice memo for the last photograph recorded can be overwritten when the camera is in shooting mode. See “Voice Memos” (149).

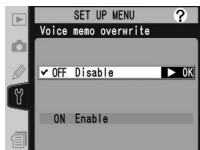

## Voice Memo Button

This option controls operation of the  button. See “Voice Memos” (149).

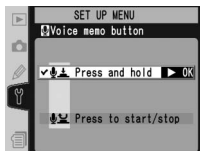

## Audio Output

This menu contains output options for voice memos. See “Voice Memos” (151).

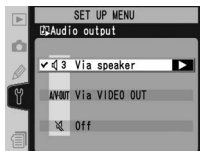

## USB

Before connecting the camera to a computer via USB (231), select the appropriate USB option as determined by the computer operating system and whether the camera is being controlled from Nikon Capture 4 version 4.2 or later (available separately) or photographs are being transferred to the computer using PictureProject.

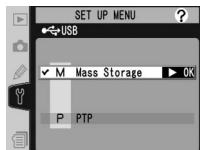

Operating system	PictureProject Transfer	Nikon Capture 4 Camera Control
Windows XP Home Edition Windows XP Professional	Choose <b>PTP</b> or <b>Mass Storage</b>	Choose <b>PTP</b>
Mac OS X		
Windows 2000 Professional Windows Millennium Edition (Me) Windows 98 Second Edition (SE)	Choose <b>Mass Storage</b>	
Mac OS 9	Not supported	

The default setting for **USB** is **Mass Storage**. To change the USB setting, highlight **USB** in the setup menu (209) and press the multi selector to the right. Press the multi selector up or down to highlight the desired option, then press the multi selector to the right.

## Dust Off Ref Photo

This option is used to acquire reference data for the Image Dust Off function in Nikon Capture 4 version 4.2 or later (available separately; for more information, see the *Nikon Capture 4 User's Manual*).

- Dust Off ref photo** is only available when a CPU lens is mounted on the camera. We recommend using a lens with a focal length of at least 50mm. If using a zoom lens, zoom in to the maximum telephoto position.
- Highlight **Dust Off ref photo** in the setup menu (209) and press the multi selector to the right. The menu shown at right will be displayed.
- Press the multi selector to the right. Camera settings will be adjusted automatically. The message shown at right will be displayed, and **rEF** will be displayed in the viewfinder and control panels.

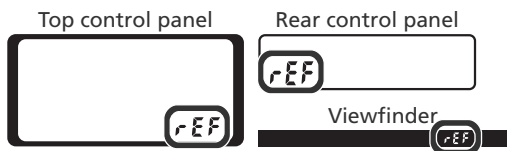

To cancel the operation and return to the setup menu, press the **MENU** button or press the multi selector to the left. The operation will also be cancelled when the camera or monitor is turned off.

## Image Dust Off

The Image Dust Off feature in Nikon Capture 4 version 4.2 or later (available separately) processes NEF (RAW) photographs to remove the effects of dust in the camera imaging system by comparing the images to the data acquired with **Dust Off ref photo**. It is not available with TIFF (RGB) or JPEG images. The same reference data can be used for NEF (RAW) photographs taken with different lenses or at different apertures.

**4** With the lens ten centimeters (four inches) from a bright, featureless white object, frame the object so that nothing else is visible in the viewfinder and press the shutter-release button halfway. In autofocus mode, focus will automatically be set to infinity; in manual focus mode, set focus to infinity manually before pressing the shutter-release button. If using the aperture ring to set aperture, choose the minimum setting (largest f/-number).

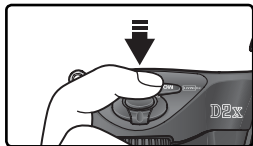

**5** Press the shutter-release button the rest of the way down to acquire Image Dust Off reference data (note that noise reduction turns on automatically when the subject is poorly lit, increasing the amount of time needed to record the data). The monitor turns off when the shutter-release button is pressed.

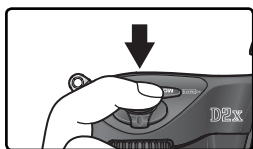

If the reference object is too bright or too dark, the camera may be unable to acquire Image Dust Off reference data and the message shown at right will be displayed. Choose another reference object and repeat the process from Step 3.



### Image Dust Off Reference Data

Image Dust Off reference data are recorded to the memory card at an image quality of JPEG Fine and an image size of Large. When the resulting image is played back on the camera, a grid pattern is displayed and voice memos can not be recorded. Files created with **Dust Off ref photo** can not be viewed using computer imaging software.

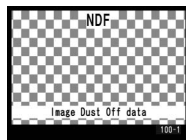



## Battery Info

To view information on the EN-EL4 rechargeable Li-ion battery currently inserted in the camera, highlight **Battery Info** in the setup menu (209) and press the multi selector to the right.

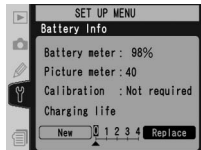

Option	Description
<b>Battery meter</b>	Current battery level expressed as a percentage (27).
<b>Picture meter</b>	Number of times shutter has been released with current battery since battery was last charged. Note that camera may sometimes release shutter without recording photograph, for example when measuring value for preset white balance.
<b>Calibration</b>	<ul style="list-style-type: none"> <li>• <b>Required:</b> due to repeated use and recharging, calibration is required to ensure that battery level can be measured accurately; recalibrate battery before charging (see MH-21 Quick Charger instructions for details).</li> <li>• <b>Not required:</b> calibration not required.</li> </ul>
<b>Charging life</b>	Five-level display showing battery age. 0 ( <b>New</b> ) indicates that battery performance has not been affected; 4 ( <b>Replace</b> ) indicates that battery has reached end of charging life and should be replaced.

## Wireless LAN

This option is only available when an optional WT-2/2A or WT-1/1A wireless transmitter is attached. To adjust wireless LAN settings, highlight **Wireless LAN** in the setup menu (209) and press the multi selector to the right. Press the multi selector up or down to highlight an option and then press the multi selector to the right. The options available vary depending on whether the WT-2/2A or WT-1/1A is attached. See the manual provided with the wireless transmitter for details.

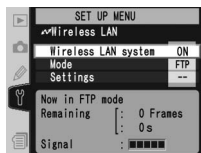

WT-2/2A

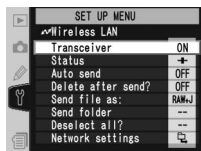

WT-1/1A

## Wireless LAN Options for the WT-2/2A

Settings for the WT-2/2A differ depending on whether the transmitter is being used to send data to an ftp server or to connect to a computer running Nikon Capture 4 Camera Control (available separately; Nikon Capture 4 version 4.2 or later required).

Option		FTP	Camera Control	
<b>Wireless LAN system</b>		Choose <b>On</b>	Choose <b>On</b>	
<b>Mode</b>		Choose <b>FTP</b>	Choose <b>PTP/IP</b>	
<b>Settings</b>	<b>Network settings</b>	<b>Wireless</b>	Required	
		<b>TCP/IP</b>	Required	
		<b>FTP</b>	Required	
	<b>Pairing options</b>		Not available	Required
	<b>Auto send</b>		Available	Not available
	<b>Delete after send?</b>		Available	Not available
	<b>Send file as</b>		Available	Not available
	<b>Send folder</b>		Available	Not available
	<b>Deselect all?</b>		Available	Not available

### Settings for the WT-2/2A and WT-1/1A

Even where the same options are available for both devices, wireless LAN settings must be adjusted separately for the WT-2/2A and WT-1/1A.

### USB

When using a wireless transmitter, set the **USB** option in the camera setup menu to **PTP** (📷 216).

## Wireless LAN system

Turn the WT-2/2A on or off. Press the multi selector up or down to highlight an option and then press the multi selector to the right.

Option	Description
<b>Off</b> (default)	WT-2/2A off; wireless link unavailable.
<b>On</b>	WT-2/2A off; wireless link available.

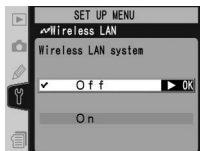

## Mode

Press the multi selector up or down to highlight **FTP** or **PTP/IP** and then press the multi selector to the right.

Option	Description
<b>FTP</b> (default)	Use when connecting to ftp server.
<b>PTP/IP</b>	Use when controlling camera remotely. Requires Nikon Capture 4 version 4.2 or later (available separately).

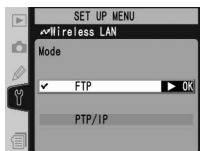

## Settings

The settings menu contains the options listed below. Press the multi selector up or down to highlight an option and then press the multi selector to the right.

Option	
<b>Network settings</b>	222
<b>Pairing options</b>	222
<b>Auto send</b>	223
<b>Delete after send?</b>	223

Option	
<b>Send file as</b>	224
<b>Send folder</b>	224
<b>Deselect all?</b>	224

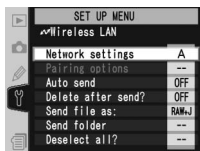

**Network settings:** Adjust settings for connection to a wireless network. Press the multi selector up or down to highlight an option and then press the multi selector to the right.

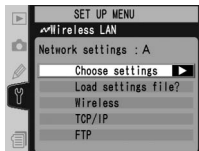

Option	Description
<b>Choose settings</b>	<b>Wireless, TCP/IP, and FTP</b> settings are stored in one of four banks (A, B, C, and D). Store settings for different networks in different banks and switch between them using this menu. Descriptive captions can be added to bank names as described on page 168.
<b>Load settings file?</b>	Load <b>Wireless, TCP/IP, and FTP</b> settings from camera memory card.
<b>Wireless</b>	Adjust SSID, ad hoc, encryption, and compatibility settings for connection to wireless network.
<b>TCP/IP</b>	Adjust or view TCP/IP settings, including IP address, DNS, and gateway settings.
<b>FTP</b>	Enter password and user ID and adjust settings for connection to ftp server.

**Pairing options:** Pair the camera with computers running Nikon Capture 4 Camera Control (requires Nikon Capture 4 version 4.2 or later, available separately). Once paired with the camera, the computer will automatically connect when Camera Control is started, allowing the camera to be controlled remotely from the computer. The camera can store up to ten pairs of connections (note that each computer can control only one camera at a time, and that each camera can be controlled by only one computer at a time). Before pairing the camera with a computer, adjust wireless network settings appropriately.



Press the multi selector up or down to highlight an option and then press the multi selector to the right.

Option	Description
<b>Camera</b>	Assign name to camera. Camera will be registered with computer under this name when pairing begins.
<b>Edit connection list</b>	Edit list of computers with which camera is paired. Computers can be deleted from list or pairing can be suspended by selecting <b>Disable</b> (remember to enable pairing before reconnecting).

**Auto send:** Choose whether to transmit photographs to the server as they are taken. Press the multi selector up or down to highlight an option and then press the multi selector to the right.

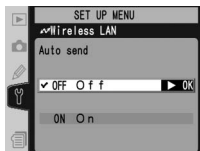

Option	Description
<b>Off</b> (default)	Photos are not transmitted automatically after shooting. Photos can be selected for transmission in playback mode.
<b>On</b>	Photos transmitted to server automatically after recording.

**Delete after send:** Choose whether to delete photographs after transmission. Press the multi selector up or down to highlight an option and then press the multi selector to the right.

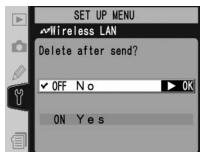

Option	Description
<b>No</b> (default)	Photos are not deleted after transmission.
<b>Yes</b>	Photos deleted after transmission. Regardless of setting selected for Custom Setting d4 ( <b>File No. Seq.</b> ), file numbering continues from last number used when new folder is created or memory card inserted.

**Send file as:** When sending images taken at settings of **NEF (Raw) + JPEG Fine**, **NEF (Raw) + JPEG Normal**, or **NEF (Raw) + JPEG Basic**, choose whether to send both NEF and JPEG files or only the JPEG files. Press the multi selector up or down to highlight an option and then press the multi selector to the right.

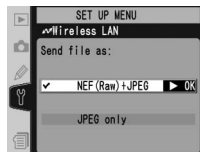

Option	Description
<b>NEF(Raw)+JPEG</b> (default)	Send both NEF and JPEG files.
<b>JPEG only</b>	Send JPEG files only.

**Send folder:** Entire folders can be selected for transmission to the server. Press the multi selector up or down to highlight a folder and then press the multi selector to the right to begin transmission of the selected folder and all files it contains.



**Deselect all:** Remove “send,” “sending,” and “sent” marking from all images on the memory card. Press the multi selector up or down to highlight an option, then press the multi selector to the right.



Option	Description
<b>No</b>	Exit without removing “send,” “sending,” and “sent” marking.
<b>Yes</b>	Remove “send,” “sending,” and “sent” marking from all images.

## Wireless LAN Options for the WT-1/1A

The following options are available when the WT-1/1A is connected.

### Transceiver

Turn the WT-1/1A transceiver on or off. Press the multi selector up or down to highlight an option and then press the multi selector to the right.



Option	Description
<b>Off</b> (default)	Transceiver off. Camera can not communicate with server.
<b>On</b>	Transceiver on. Camera can communicate with server.

### Status

Shows the current status of the link between the WT-1/1A and the server. Press the multi selector to the right to return to the wireless LAN menu.

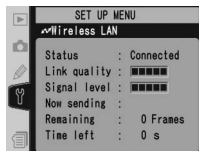

Option	Description
<b>Status</b>	Status of server link.
<b>Link quality</b>	Five-level indicator of link quality.
<b>Signal level</b>	Five-level indicator of signal strength.
<b>Now sending</b>	Name of file currently being sent.
<b>Remaining</b>	Number of frames yet to be sent.
<b>Time left</b>	Estimated time needed to send remaining data.

### Auto Send

Choose whether to transmit photographs to the server as they are taken. See “Auto send” (223).



### Delete After Send?

Choose whether to delete photographs after transmission. See “Delete after send” (📷 223).

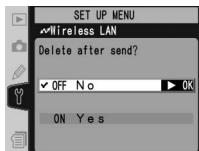

### Send File As

When sending images taken at settings of **NEF (Raw) + JPEG Fine**, **NEF (Raw) + JPEG Normal**, or **NEF (Raw) + JPEG Basic**, choose whether to send both NEF and JPEG files or only the JPEG files. See “Send file as” (📷 224).

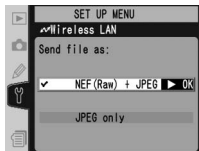

### Send Folder

Entire folders can be selected for transmission to the server. See “Send folder” (📷 224).



### Deselect All?

Remove “send,” “sending,” and “sent” marking from all images on the memory card. See “Deselect all” (📷 224).

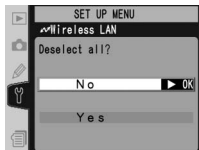

### Settings for the WT-2/2A and WT-1/1A

Even where the same options are available for both devices, wireless LAN settings must be adjusted separately for the WT-2/2A and WT-1/1A.

### USB

When using a wireless transmitter, set the **USB** option in the camera setup menu to **PTP** (📷 216).



## Network Settings

Adjust network settings for connection to the server. Press the multi selector up or down to highlight an option and then press the multi selector to the right.

Option	Description
<b>Load settings file?</b>	Load <b>Wireless</b> , <b>TCP/IP</b> , and <b>FTP</b> settings from camera memory card.
<b>Wireless</b>	Adjust settings for connection to wireless network.
<b>TCP/IP</b>	Adjust TCP/IP settings, including IP address, DNS, and gateway settings.
<b>FTP</b>	Enter password and user ID and adjust settings for connection to ftp server

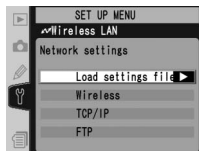

## Firmware Version

To display the current camera firmware version, highlight **Firmware Version** in the setup menu (209) and press the multi selector to the right. Press the multi selector to the left to return to the setup menu.

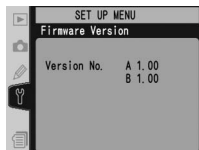



# Connections

*Connecting to External Devices*

Television Playback



230



Connecting to a Computer



231–233



Connecting to a Printer



234–238



Photographs and camera menus can be displayed on a television screen or recorded to video tape. If the supplied software is installed, the camera can be connected to a computer and photographs copied to disk for editing, viewing, printing, or long-term storage. When the camera is connected to a PictBridge-compatible printer, pictures can be printed directly from the camera.

## ***Television Playback***

Read this section for information on connecting the camera to a television or VCR.

## ***Connecting to a Computer***

This section describes how to connect the camera to a computer.

## ***Connecting to a Printer***

Read this section for information on connecting the camera to a PictBridge-compatible printer.

# Television Playback

Connecting the Camera to a Video Device

The supplied EG-D2 audio/video (A/V) cable can be used to connect the D2X to a television or VCR for playback or recording.

**1** Turn the camera off.

 **The EG-D2**

Turn the camera off before connecting or disconnecting the EG-D2.

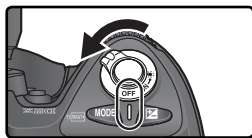

**2** Open the cover protecting the A/V-out and DC-in connectors.

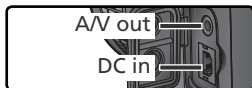

**3** Connect the EG-D2. Insert the black plug to the camera A/V-out connector. Connect the yellow plug to the video-in jack on the television or VCR and the white plug to the audio-in jack.

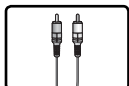

Connect to video device

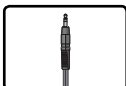
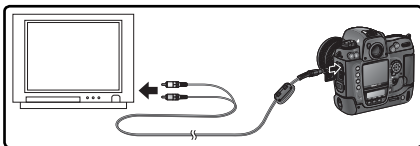

Connect to camera

**4** Tune the television to the video channel.

**5** Turn the camera on. During playback, images will be displayed on the television screen or recorded to video tape; the camera monitor will remain off. Note that the television may not be able to display the entire image when pictures are played back.

 **Use an AC Adapter**

Use of an EH-6 AC adapter (available separately) is recommended for extended playback. When the EH-6 is connected, the camera monitor-off delay will be fixed at ten minutes and the exposure meters will no longer turn off automatically.

 **Video Mode (212)**

Be sure that the video standard matches the standard used in the video device. Note that resolution will drop when images are output on a PAL device.

 **Audio Output (151)**

Set **Via VIDEO OUT** to play back or record voice memos on the video device.

# Connecting to a Computer

## Data Transfer and Camera Control

The supplied UC-E4 USB cable can be used to connect the camera to a computer. Once the camera is connected, PictureProject can be used to copy photographs to the computer, where they can be browsed, viewed, and retouched. The camera can also be used with Nikon Capture 4 version 4.2 or later (available separately), which supports batch processing and more advanced image editing options and can be used to control the camera directly from the computer.

### Before Connecting the Camera

Install the necessary software after reading the manuals and reviewing the system requirements. To ensure that data transfer is not interrupted, be sure the camera battery is fully charged. If in doubt, charge the battery before use or use an EH-6 AC adapter (available separately).

Before connecting the camera, set the USB option in the setup menu (216) according to the computer operating system and whether the camera is being controlled from Nikon Capture 4 version 4.2 or later (available separately) or photographs are being transferred to the computer using PictureProject:



Operating system	PictureProject Transfer	Nikon Capture 4 Camera Control
Windows XP Home Edition Windows XP Professional	Choose <b>PTP</b> or <b>Mass Storage</b>	Choose <b>PTP</b>
Mac OS X		
Windows 2000 Professional Windows Millennium Edition (Me) Windows 98 Second Edition (SE)	Choose <b>Mass Storage</b> *	
Mac OS 9	Not supported	

\* Do NOT select **PTP**. If **PTP** is selected when the camera is connected, the Windows hardware wizard will be displayed. Click **Cancel** to exit the wizard, and then disconnect the camera. Be sure to select **Mass storage** before reconnecting the camera.

## Connecting the USB Cable

- 1 Turn the computer on and wait for it to start up.
- 2 Turn the camera off. 
- 3 Connect the UC-E4 USB cable as shown. Connect the camera directly to the computer; do not connect the cable via a USB hub or keyboard.

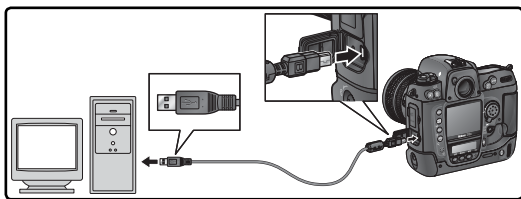

- 4 Turn the camera on. If **Mass Storage** is selected for **USB**, **PC** will be displayed in the rear control panel and viewfinder. The aperture display in the top control panel will also show **PC**, and the PC mode indicator will flash (if **PTP** is selected, the camera displays will only change when Nikon Capture 4 Camera Control is running). Photographs can be transferred to the computer as described in the *PictureProject Reference Manual* (on CD).



If Nikon Capture 4 Camera Control is running, the top control panel will show **PC** in place of the number of exposures remaining. Any photographs taken will be recorded to the computer hard disk rather than the camera memory card. See the *Nikon Capture 4 User's Manual* for more information.

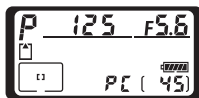

### ✓ Do Not Turn the Camera Off

Do not turn the camera off while transfer is in progress.

## Disconnecting the Camera

If **PTP** is selected for **USB** (see 216), the camera can be turned off and the USB cable disconnected once transfer is complete. If the **USB** option in the camera setup menu is still at its default setting of **Mass storage**, the camera must first be removed from the system as described below.

### Windows XP Home Edition/Windows XP Professional

Click the “Safely Remove Hardware” icon (🔌) in the taskbar and select **Safely remove USB Mass Storage Device** from the menu that appears.



### Windows 2000 Professional

Click the “Unplug or Eject Hardware” icon (🔌) in the taskbar and select **Stop USB Mass Storage Device** from the menu that appears.



### Windows Millennium Edition (Me)

Click the “Unplug or Eject Hardware” icon (🔌) in the taskbar and select **Stop USB Disk** from the menu that appears.



### Windows 98 Second Edition (SE)

In My Computer, click with the right mouse button on the removable disk corresponding to the camera and select **Eject** from the menu that appears.

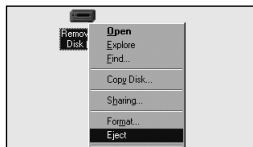

### Macintosh

Drag the camera volume (“NIKON D2X”) into the Trash.

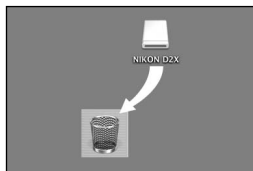

When the camera is connected to a PictBridge-compatible printer via the supplied UC-E4 USB cable, selected JPEG images can be printed directly from the camera. Before connecting the printer, confirm that it supports PictBridge. If possible, connect the camera to an EH-6 AC adapter (available separately) to reduce the drain on the battery.

- 1 Set the **USB** option in the setup menu (P. 216) to **PTP** (photographs can not be printed at the default setting of **Mass Storage**).

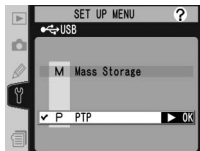

- 2 Turn the printer on.

- 3 Turn the camera off.



- 4 Connect the UC-E4 USB cable as shown. Connect the camera directly to the printer; do not connect the cable via a USB hub.

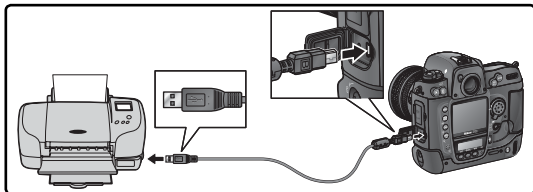

### Taking Pictures for Direct Printing

When taking photographs to be printed without modification, set **Color space** to **sRGB** (P. 69).

### Print Times

Larger images require more time to print.





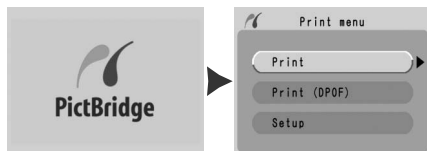

- 5 Turn the camera on. A welcome screen will be displayed in the monitor, followed by a PictBridge menu.



- 6 Press the multi selector up or down to highlight **Setup** and press the multi selector to the right. The menu shown at right will be displayed; press the multi selector up or down to highlight an option, then press the multi selector to the right to make the selection.



Option	Description
<b>Done</b>	Save changes and return to PictBridge menu.
<b>Page size</b>	Choose page size. Press multi selector up or down to highlight  (default size for current printer), <b>3.5" x 5"</b> , <b>5" x 7"</b> , <b>Hagaki</b> , <b>100 mm x 150 mm</b> , <b>4" x 6"</b> , <b>8" x 10"</b> , <b>Letter</b> , <b>A3</b> , or <b>A4</b> , then press to right to select.
<b>Imprint date</b>	Check to print date of recording on each picture.
<b>No border</b>	Check to print pictures without white border (some printers will ignore this option).

- 7 To select photographs for printing or create an index print of all JPEG images on the memory card, highlight **Print** in the PictBridge menu and press the multi selector to the right ( 236–237). To print the print order created with the playback **Print set** option ( 161), highlight **Print (DPOF)** and press the multi selector to the right ( 238).

### Using the Multi Selector

The multi selector can be used at any time when the monitor is on. The focus selector lock switch only takes effect when the monitor is off.

## Printing Selected Photographs

To print selected photos, highlight **Print** in the PictBridge menu and press the multi selector to the right. The menu shown in Step 1 will be displayed.

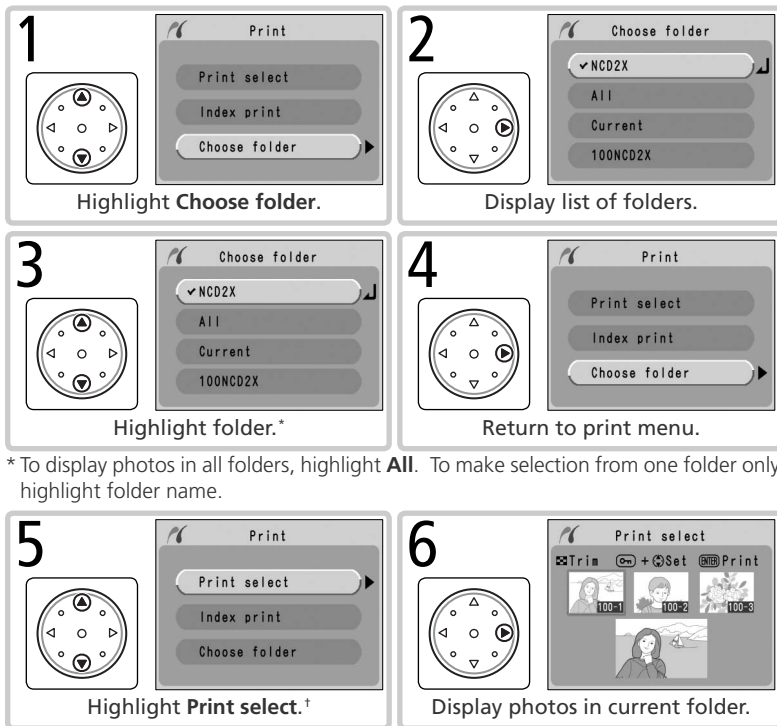

\* To display photos in all folders, highlight **All**. To make selection from one folder only, highlight folder name.

† To create index print listing all JPEG images in current folder as small thumbnail images, highlight **Index print** and press multi selector to right (do not select **Page size** when creating index prints). Photos in current folder will be displayed, with JPEG images marked by  icon. Press **Print** to begin printing. To interrupt printing and exit to PictBridge menu, press **Print** button again.

### Selecting Photographs for Printing

NEF (RAW) and TIFF (RGB) images are not displayed in the **Print select** menu and can not be selected.

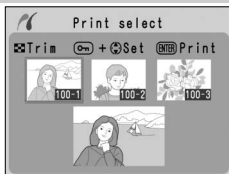
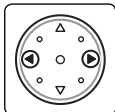

7



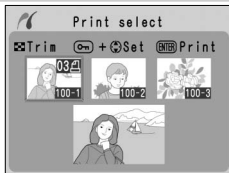
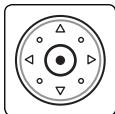

Scroll through photos. Current photo shown at bottom of display.

8



Select photo and set number of prints to 1. Selected photos are marked by  icon. Press  button and press multi-selector up or down to specify number of prints (up to 99).<sup>‡</sup>

<sup>‡</sup>If printer supports cropping, photo can be cropped for printing by pressing  button. Dialog shown at right will be displayed; rotate main command dial to zoom in or out and use multi-selector to scroll to other areas of image (note that prints may become slightly “grainy” when highly enlarged). When desired area is framed in monitor, press  button to return to print selection dialog. Only selected portion of photo will be included when image is printed.



9 Repeat steps 7 and 8 to select additional pictures. To deselect picture, highlight and press center of multi-selector. To exit to PictBridge menu without printing, press  button.

10





Begin printing. To cancel and return to PictBridge menu before all images have been printed, press  button again. Turn camera off and disconnect USB cable when printing is complete.

## Printing the Current Print Order

To print the current print order, highlight **Print (DPOF)** in the PictBridge menu and press the multi selector to the right. This option is only available if a print order is present on the memory card.

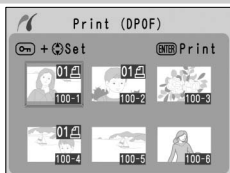
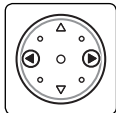
1



View photos in current folder. Pictures in print order are indicated by  icon and number of prints; print order can be changed as described on page 162. To exit to PictBridge menu without printing, press  button.

2



Begin printing. To cancel and return to PictBridge menu before all images have been printed, press  button again. Turn camera off and disconnect USB cable when printing is complete.

### "Data Imprint"/"Imprint Date"

Selecting **Print (DPOF)** resets the **Data imprint** and **Imprint date** options for the current print order ( 162). To print the date of recording on photographs, select **Imprint date** in the PictBridge **Setup** menu.

### Error Messages

If the dialog shown at right is displayed, an error has occurred. After checking the printer and resolving any problems as directed in the printer manual, press the multi selector up or down to highlight **Continue** and press the multi selector to the right to resume printing. Select **Cancel** to exit without printing the remaining images.



### Print Set ( 161)

To create a DPOF print order before printing, use the **Print set** option in the playback menu.

---

# **Technical Notes**

*Camera Care, Options, and Resources*

---

This chapter covers the following topics:

***Optional Accessories***

A list of the lenses and other accessories available for the D2X.

***Caring for the Camera***

Information on storage and maintenance.

***Troubleshooting***

A list of the error messages displayed by your camera and how to deal with them.

***Specifications***

Principal specifications for the D2X.

### Lenses for the D2X

The D2X is compatible with a variety of AF Nikkor lenses for 35-mm film cameras, including wide-angle, telephoto, zoom, micro, defocus image control (DC), and regular lenses with focal lengths of 14–600 mm (📷 242). Note that IX Nikkor CPU lenses can not be used with the D2X.

The lenses that can be used with the D2X are listed below.

Camera setting Lens/accessory		Focus mode			Exposure mode		Metering system		
		S C	M (with electronic range finder)	M	P S	A M	📷		📷 •
							3D	Color	
CPU Lenses <sup>1</sup>	Type G or D AF Nikkor <sup>2</sup> AF-S, AF-I Nikkor	✓	✓	✓	✓	✓	✓	—	✓ <sup>3</sup>
	PC-Micro Nikkor 85 mm f/2.8D <sup>4</sup>	—	✓ <sup>5</sup>	✓	—	✓ <sup>6</sup>	✓	—	✓ <sup>3</sup>
	AF-S/AF-I Teleconverter <sup>7</sup>	✓ <sup>8</sup>	✓ <sup>8</sup>	✓	✓	✓	✓	—	✓ <sup>3</sup>
	Other AF Nikkor (except lenses for F3AF)	✓ <sup>9</sup>	✓ <sup>9</sup>	✓	✓	✓	—	✓	✓ <sup>3</sup>
	AI-P Nikkor	—	✓ <sup>10</sup>	✓	✓	✓	—	✓	✓ <sup>3</sup>
Non-CPU Lenses <sup>11</sup>	AI-, AI-S, or Series E Nikkor <sup>12</sup> AI modified Nikkor	—	✓ <sup>10</sup>	✓	—	✓ <sup>13</sup>	—	✓ <sup>14</sup>	✓ <sup>15</sup>
	Medical Nikkor 120 mm f/4	—	✓	✓	—	✓ <sup>16</sup>	—	—	—
	Reflex Nikkor	—	—	✓	—	✓ <sup>13</sup>	—	—	✓ <sup>15</sup>
	PC-Nikkor	—	✓ <sup>5</sup>	✓	—	✓ <sup>17</sup>	—	—	✓
	AI-type Teleconverter <sup>18</sup>	—	✓ <sup>8</sup>	✓	—	✓ <sup>13</sup>	—	✓ <sup>14</sup>	✓ <sup>15</sup>
	TC-16A AF Teleconverter	✓ <sup>8</sup>	✓ <sup>8</sup>	✓	—	✓ <sup>13</sup>	—	✓ <sup>14</sup>	✓ <sup>15</sup>
	PB-6 Bellows Focusing Attach- ment <sup>19</sup>	—	✓ <sup>8</sup>	✓	—	✓ <sup>20</sup>	—	—	✓
Auto extension rings (PK-series 11A, 12, or 13; PN-11)	—	✓ <sup>8</sup>	✓	—	✓ <sup>13</sup>	—	—	✓	

1 IX-Nikkor lenses can not be used.

2 Vibration Reduction (VR) supported with VR lenses.

3 Spot metering meters selected focus area.

4 The camera's exposure metering and flash control systems do not work properly when shifting and/or tilting the lens, or when an aperture other than the maximum aperture is used.

5 Electronic range finder can not be used with shifting or tilting.

6 Manual exposure mode only.

7 Compatible with AF-I Nikkor lenses and with all AF-S lenses except DX 12–24 mm f/4G ED, 17–35 mm f/2.8D ED, DX 17–55 mm f/2.8G ED, 24–85 mm f/3.5–4.5G ED, VR 24–120 mm f/3.5–5.6G ED, and 28–70 mm f/2.8D ED.

8 With maximum effective aperture of f/5.6 or faster.

9 When focusing at minimum focus distance with AF 80–200 mm

- f/2.85, AF 35–70mm f/2.85, new AF 28–85mm f/3.5–4.5S, or AF 28–85mm f/3.5–4.5S lens at maximum zoom, in-focus indicator may be displayed when image on matte screen in viewfinder is not in focus. Adjust focus manually until image in viewfinder is in focus.
- 10 With maximum aperture of f/5.6 or faster.
  - 11 Some lenses can not be used (see below).
  - 12 Range of rotation for Ai 80–200mm f/2.85 ED tripod mount limited by camera body. Filters can not be exchanged while Ai 200–400mm f/4S ED is mounted on camera.
  - 13 If maximum aperture is specified using **Non-CPU lens data** option in shooting menu, aperture value will be displayed in viewfinder and top control panel.
  - 14 Can be used only if lens focal length and maximum aperture are specified using **Non-CPU lens data** option in shooting menu. Use spot or center-weighted metering if desired results are not achieved.
  - 15 For improved precision, specify lens focal length and maximum aperture using **Non-CPU lens data** option in shooting menu.
  - 16 Can be used at in manual exposure modes at shutter speeds slower than 1/125s. If maximum aperture is specified using **Non-CPU lens data** option in shooting menu, aperture value will be displayed in viewfinder and top control panel.
  - 17 Exposure determined by presetting lens aperture. In aperture-priority auto exposure mode, preset aperture using lens aperture ring before performing AE lock or shifting lens. In manual exposure mode, preset aperture using lens aperture ring and determine exposure before shifting lens.
  - 18 Exposure compensation required when used with AI 28–85mm f/3.5–4.5S, AI 35–105mm f/3.5–4.5S, AI 35–135mm f/3.5–4.5S, or AF-S 80–200mm f/2.8D. See teleconverter manual for details.
  - 19 Requires PK-12 or PK-13 auto extension ring. PB-6D may be required depending on camera orientation.
  - 20 Use preset aperture. In manual exposure mode, set aperture using focusing attachment before determining exposure and taking photograph.
    - PF-4 Reprocopy Outfit requires PA-4 Camera Holder.

## Incompatible Accessories and Non-CPU Lenses

The following accessories and non-CPU lenses can NOT be used with the D2X:

- Non-AI lenses
- Lenses that require the AU-1 focusing unit (400mm f/4.5, 600mm f/5.6, 800mm f/8, 1200mm f/11)
- Fisheye (6mm f/5.6, 8mm f/8, OP 10mm f/5.6)
- 21mm f/4 (old type)
- K2 rings
- ED 180–600mm f/8 (serial numbers 174041–174180)
- ED 360–1200mm f/11 (serial numbers 174031–174127)
- 200–600mm f/9.5 (serial numbers 280001–300490)
- Lenses for the F3AF (80mm f/2.8, 200mm f/3.5, TC-16 Teleconverter)
- PC 28mm f/4 (serial number 180900 or earlier)
- PC 35mm f/2.8 (serial numbers 851001–906200)
- PC 35mm f/3.5 (old type)
- 1000mm f/6.3 Reflex (old type)
- 1000mm f/11 Reflex (serial numbers 142361–143000)
- 2000mm f/11 Reflex (serial numbers 200111–200310)

## Compatible Non-CPU Lenses

If lens data are specified using the **Non-CPU lens data** option in the shooting menu, many of the features available with CPU lenses can also be used with non-CPU lenses. If lens data are not specified, color matrix metering can not be used, and center-weighted metering is used when matrix metering is selected.

Non-CPU lenses can only be used in exposure modes A and M, when aperture must be set using the lens aperture ring. If the maximum aperture has not been specified using **Non-CPU lens data**, the camera aperture display will show the number of stops from maximum aperture; the actual aperture value must be read off the lens aperture ring. Aperture-priority auto will be selected automatically in exposure modes P and S. The exposure-mode indicator in the top control panel will blink, and **A** will be displayed in the viewfinder.

CPU lenses can be identified by the presence of CPU contacts. Type G lenses are marked with a “G” on the lens barrel, type D lenses with a “D.”

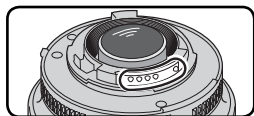

CPU lens

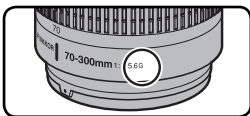

Type G lens



Type D lens

Type G lenses are not equipped with a lens aperture ring. Unlike other CPU lenses, there is no need to lock the aperture ring at the minimum aperture setting (maximum *f*-number) when using a type G lens.

### Picture Angle and Focal Length

The diagonal picture angle of the D2X is less than that of a 35-mm camera. When calculating the focal length of the lenses for the D2X in 35-mm format, multiply the focal length of the lens by about 1.5 (high-speed crop mode off) or 2 (high-speed crop mode on):

Picture angle		Approximate focal length (mm) in 35-mm format (modified for picture angle)							
		17	20	24	28	35	50	60	85
35-mm film camera		17	20	24	28	35	50	60	85
D2X	Hi-speed crop: Off	25.5	30	36	42	52.5	75	90	127.5
	Hi-speed crop: On	34	40	48	56	70	100	120	170
35-mm film camera		105	135	180	200	300	400	500	600
D2X	Hi-speed crop: Off	157.5	202.5	270	300	450	600	750	900
	Hi-speed crop: On	210	170	360	400	600	800	1000	1200

### Calculating Picture Angle

The size of the area exposed by a 35-mm camera is 36 × 24 mm. The size of the area exposed by the D2X, in contrast, is 23.7 × 15.7 mm (high-speed crop off) or 17.7 × 11.7 mm (high-speed crop on). As a result, the picture angle of photographs taken with the D2X differs from the picture angle for 35-mm cameras, even when the focal length of the lens and the distance to the subject are the same.

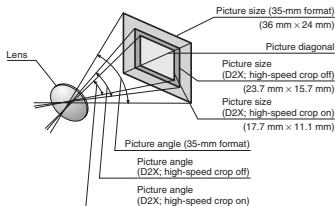





## Other Accessories

At the time of writing, the following accessories were available for the D2X. Contact your retailer or local Nikon representative for details.

<b>Batteries/ Chargers/ AC adapters</b>	<ul style="list-style-type: none"><li>◆ <b>EN-EL4 Rechargeable Li-ion Battery:</b> Additional EN-EL4 batteries are available from local retailers and Nikon service representatives.</li><li>◆ <b>MH-21 Quick Charger:</b> The MH-21 can be used to recharge and calibrate EN-EL4 batteries. It can fully recharge an exhausted EN-EL4 battery in about 100 minutes.</li><li>◆ <b>EH-6 AC Adapter:</b> The EH-6 can be used with AC power sources of 50–60Hz and 100–120V or 200–240V. Separate power cables are available for use in North America, the United Kingdom, continental Europe, Australia, and Japan.</li></ul>
<b>Wireless LAN adapters and antennas</b>	<ul style="list-style-type: none"><li>◆ <b>WT-2/2A and WT-1/1A Wireless Transmitters:</b> These wireless transmitters are mounted on the bottom of the camera and connect via a USB cable. Power is supplied from the camera. The WT-2/2A supports IEEE 802.11g for high-speed wireless transmission, and can be used in combination with Nikon Capture 4 version 4.2 or later (available separately) to control the camera remotely with Nikon Capture 4 Camera Control. Both models support IEEE 802.11b and can be used to upload photographs to an ftp server over a wireless network. See pages 219–227 for more information.</li><li>◆ <b>WA-E1 Extended Range Antenna:</b> Extends line-of-sight range of WT-2/2A and WT-1/1A to a maximum of about 150 m (outdoors, 1 Mbps)</li></ul>

### Use Only Nikon Brand Electronic Accessories

Your Nikon D2X digital camera is designed to the highest standards and includes complex electronic circuitry. Only Nikon brand electronic accessories (including battery chargers, batteries, and AC adapters) certified by Nikon specifically for use with your Nikon digital camera are engineered and proven to operate within the operational and safety requirements of this electronic circuitry.

THE USE OF NON-NIKON ELECTRONIC ACCESSORIES COULD DAMAGE YOUR CAMERA AND MAY VOID YOUR NIKON WARRANTY. The use of third-party rechargeable Li-ion batteries not approved by Nikon could interfere with normal operation of the camera or result in the batteries overheating, igniting, rupturing, or leaking.

For more information about Nikon brand accessories, contact your local authorized Nikon dealer.



## Viewfinder eyepiece accessories

◆ **Focusing Screens:** The focusing screens available for the D2X are listed below. Type B and E screens can also be used with the D2H.

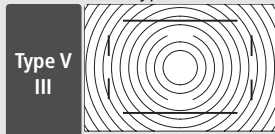
Type V  
III

The D2X comes with a type V clear-matte III focusing screen (for use with the D2X only) which shows the full high-speed crop for enhanced high-speed crop photography.

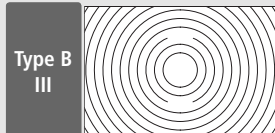
Type B  
III

A type B BriteView III focusing screen is supplied with the camera.

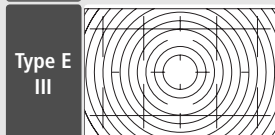
Type E  
III

The type E clear-matte III focusing screen is etched with a grid, making it suitable for copying and architectural photography. Best results are achieved with PC-Nikkor lenses.

◆ **DG-2 Magnifier:** The DG-2 magnifies the scene displayed in the viewfinder. Use for close-up photography, copying, telephoto lenses, and other tasks that call for added precision. DK-7 eyepiece adapter (available separately) required.

◆ **DK-14 and DK-17A Antifog Finder Eyepieces:** These viewfinder eyepieces prevent fogging in humid or cold conditions. The DK-17A is equipped with a safety lock.

◆ **DK-19 Rubber Eyepiece Cup:** The DK-19 makes the image in the viewfinder easier to see, preventing eye fatigue.

◆ **Diopter-Adjustment Viewfinder Lenses:** To accommodate individual differences in vision, viewfinder lenses are available with diopters of  $-3$ ,  $-2$ ,  $0$ ,  $+1$ , and  $+2m^{-1}$ . The DK-17C is equipped with a safety lock.

◆ **DR-5 Right-Angle Magnifying Viewing Attachment/DR-4 Right-Angle Viewing Attachment:** The DR-4 and DR-5 attach to the viewfinder eyepiece at a right angle, allowing the image in the viewfinder to be viewed from above when the camera is in the horizontal shooting position. The DR-5 can also magnify the view through the viewfinder by  $2\times$  for greater precision when framing (note that the edges of the frame will not be visible when the view is magnified).

◆ **DK-7 Eyepiece Adapter:** The DK-7 is used when attaching the DG-2 Magnifier or DR-3 Right-Angle Viewing Attachment to the D2X.

**Filters**

- Nikon filters can be divided into three types: screw-in, drop-in, and rear-interchange. Use Nikon filters; filters manufactured by other makers may interfere with autofocus or electronic range finding.
- The D2X can not be used with linear polarizing filters. Use the C-PL circular polarizing filter instead.
- The NC and L37C filters are recommended for protecting the lens.
- When using an R60 filter, set exposure compensation to +1.
- To prevent moiré, use of a filter is not recommended when the subject is framed against a bright light, or when a bright light source is in the frame.
- Color matrix and 3D color matrix metering may not produce the desired results when used with filters with an exposure factor (filter factor) over  $1 \times$  (Y44, Y48, Y52, O56, R60, X0, X1, C-PL, ND2S, ND4S, ND4, ND8S, ND8, ND400, A2, A12, B2, B8, B12). We recommend center-weighted metering. For details, see the manual provided with the filter.

**Optional Speedlights**

◆ **SB-800:** This high performance Speedlight has a Guide Number of 38/125 (m/ft, 35-mm zoom head position, ISO 100) and supports i-TTL, TTL, auto aperture (AA), non-TTL auto (A), manual, and repeating flash control. Flash sync mode, including slow and rear-curtain sync, can be set from the camera. When used with the D2X, the SB-800 supports Auto FP High-Speed Sync for sync speeds faster than  $\frac{1}{250}$ s (repeating flash mode excluded), Flash Color Information Communication for optimal white balance, FV Lock for recomposing photos without changing flash level, and Advanced Wireless Lighting with support for i-TTL, auto aperture, manual, and repeating flash control. The built-in AF-assist illuminator can be used with all of the D2X's eleven focus areas. For bounce-flash or close-up photography, the flash head can be rotated through  $90^\circ$  above and  $7^\circ$  below the horizontal,  $180^\circ$  left, and  $90^\circ$  right, while soft lighting can be achieved with the supplied SW-10H bounce adapter. Auto power zoom (24–105 mm) ensures that the illuminating is adjusted in accord with lens focal length. The built-in wide panel can be used for illuminating angles of 14 mm and 17 mm. An illuminator is included to assist in adjusting settings in the dark. The SB-800 accepts four AA batteries (five AA batteries when powered by the supplied SD-800 battery pack) or SD-6, SD-7, or SD-8A power sources (available separately; see the Speedlight manual for details). Custom settings are available for fine-tuning all aspects of flash operation.

**Optional Speedlights (continued)**

◆ **SB-600:** This high performance Speedlight has a Guide Number of 30/98 (m/ft, 35-mm zoom head position, ISO 100) and supports i-TTL, TTL, and manual flash control. Flash sync mode, including slow and rear-curtain sync, can be set from the camera. When used with the D2X, the SB-600 supports Auto FP High-Speed Sync for sync speeds faster than  $\frac{1}{250}s$ , Flash Color Information Communication for optimal white balance, and FV Lock for recomposing photos without changing flash level. With an SB-800 acting as a master flash, Advanced Wireless Lighting allows the SB-600 to serve as a remote slave flash in i-TTL and manual flash control modes. The built-in AF-assist illuminator can be used with all of the D2X's eleven focus areas. For bounce-flash or close-up photography, the flash head can be rotated through 90° above the horizontal, 180° left, and 90° right. Auto power zoom (24–85 mm) ensures that the illuminating is adjusted in accord with lens focal length. The built-in wide panel can be used for an illuminating angle of 14 mm. An illuminator is included to assist in adjusting settings in the dark. The SB-600 accepts four AA batteries (see the Speedlight manual for details). Custom settings are available for fine-tuning all aspects of flash operation.

When using the D2X with the SB-800 or SB-600, refer to the listing for CLS- (Creative Lighting System) compatible or digital SLR cameras in the Speedlight manual.

**PC card adapters**

◆ **EC-AD1 PC Card Adapter:** The EC-AD1 PC card adapter allows Type I CompactFlash memory cards to be inserted in PCMCIA card slots.

**Software**

◆ **Nikon Capture 4 (version 4.2 or later):** Nikon Capture 4 version 4.2 or later can be used to capture photos to a computer and to edit and save RAW images in other formats.

**Remote terminal accessories**

The D2X is equipped with a ten-pin remote terminal for remote control and automatic photography. The terminal is provided with a cap, which protects the contacts when the terminal is not in use. The following accessories can be used:

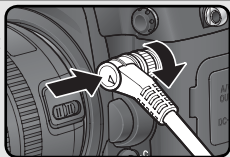

Accessory	Description	Length*
MC-21 Extension Cord	Can be connected to MC-series 22, 25, or 30.	3 m (9'10")
MC-22 Remote Cord	Remote shutter release with blue, yellow, and black terminals for connection to a remote shutter-triggering device, allowing control via sound or electronic signals.	1 m (3'3")
MC-23 Connecting Cord	Connects two cameras for simultaneous operation.	40 cm (1'4")
MC-25 Adapter Cord	Ten-pin to two-pin adapter cord for connection to devices with two-pin terminals, including the MW-2 radio control set, MT-2 intervalometer, and ML-2 modulite control set.	20 cm (8")
MC-30 Remote Cord	Remote shutter release; can be used to reduce camera shake or keep the shutter open during a time exposure.	80 cm (2'7")
MC-35 GPS Adapter Cord	Connects GPS devices to D2X via PC cable supplied by manufacturer of GPS device (📍 132).	—
MC-36 Remote Cord	Remote shutter release; can be used to reduce camera shake or keep the shutter open during a time exposure. Equipped with back-lit control panel, shutter-release lock for use in bulb photography, and timer that beeps at one-second intervals.	85 cm (2'9")
ML-3 Modulite Remote Control Set	Allows infrared remote control at ranges of up to 8 m (26').	—

\* All figures are approximate.

## Approved Memory Cards

The following cards have been tested and approved for use in the D2X:

SanDisk	SDCFB	128 MB, 160 MB, 192 MB, 256 MB, 384 MB, 512 MB, 1 GB
	SDCFB (Type II)	300 MB
	SDCF2B (Type II)	256 MB
	SDCFH (Ultra)	128 MB, 192 MB, 256 MB, 384 MB, 512 MB
	SDCFH (Ultra II)	256 MB, 512 MB, 1 GB
	SDCFX (Extreme III)	1 GB, 2 GB
Lexar Media	4× USB	128 MB, 256 MB, 512 MB
	10× USB	160 MB
	12× USB	128 MB, 192 MB, 256 MB, 512 MB
	16× USB	256 MB, 320 MB, 512 MB, 640 MB, 1 GB
	24× USB	256 MB
	16× WA USB	128 MB, 256 MB, 512 MB
	40× WA USB	256 MB, 512 MB, 1 GB, 2 GB, 4 GB
	80× WA	512 MB, 1 GB, 2 GB, 4 GB
Microdrive		340 MB, 512 MB, 1 GB, 2 GB, 4 GB

Operation is not guaranteed with other makes of card. For more details on the above cards, please contact the manufacturer.

### ✓ Memory Cards

- Memory cards may be hot after use. Observe due caution when removing memory cards from the camera.
- Format memory cards before first use or after data have been written to or deleted from the card by a device other than the camera.
- Turn the power off before inserting or removing memory cards. Do not remove memory cards from the camera, turn the camera off, or remove or disconnect the power source during formatting or while data are being recorded, deleted, or copied to a computer. Failure to observe these precautions could result in loss of data or in damage to the camera or card.
- Do not touch the card terminals with your fingers or metal objects.
- Do not apply force to the card casing. Failure to observe this precaution could damage the card.
- Do not bend, drop, or subject to strong physical shocks.
- Do not expose to water, high levels of humidity, or direct sunlight.

### Storage

When the camera will not be used for an extended period, replace the monitor cover, remove the battery, and store the battery in a cool, dry area with the terminal cover in place. To prevent mold or mildew, store the camera in a dry, well-ventilated area. Do not store your camera with naphtha or camphor moth balls or in locations that:

- are poorly ventilated or damp
- are next to equipment that produces strong electromagnetic fields, such as televisions or radios
- are exposed to temperatures above 50°C/122°F (for example, near a space heater or in a closed vehicle on a hot day) or below -10°C (14°F)
- are subject to humidities of over 60%

See “Caring for the Camera and Battery” (iv–v) for more information.

### Cleaning

<b>Camera body</b>	Use a blower to remove dust and lint, then wipe gently with a soft, dry cloth. After using the camera at the beach or seaside, wipe off sand or salt with a cloth lightly dampened in distilled water and dry thoroughly.
<b>Lens, mirror, and viewfinder</b>	These elements are made of glass and are easily damaged. Remove dust and lint with a blower. If using an aerosol blower, keep the can vertical to prevent the discharge of liquid. To remove fingerprints and other stains, apply a small amount of lens cleaner to a soft cloth and clean with care.
<b>Monitor</b>	Remove dust and lint with a blower. When removing fingerprints and other stains, wipe the surface lightly with a soft cloth or chamois leather. Do not apply pressure, as this could result in damage or malfunction.
<b>Ambient light sensor</b>	Use a blower to remove dust and lint, then wipe gently with a soft, dry cloth. Do not use alcohol or lens cleaning solutions.

### ✓ The Monitor

Should the monitor break, care should be taken to avoid injury caused by broken glass and to prevent liquid crystal from entering your eyes and mouth.

### ✎ The Control Panel

Rarely, static electricity may cause the control panel to brighten or darken. This does not indicate a malfunction; the display will shortly return to normal.

## Replacing the Focusing Screen

A type V clear-matte III focusing screen, which shows the borders of the high-speed crop, is inserted in the camera at shipment. To insert the supplied type B BriteView III or optional type E clear-matte III focusing screen (B 244):

- 1 Turn the camera off and remove the lens.
- 2 Using the tweezers supplied with the focusing screen, pull the focusing screen latch towards you. The screen holder will spring open.
- 3 Remove the existing screen, using the supplied tweezers and being careful to handle the screen by the tab to avoid scratches.
- 4 Using the tweezers and handling the screen by the tab, set the replacement screen in the holder.
- 5 Push the front edge of holder upward until it clicks into place.

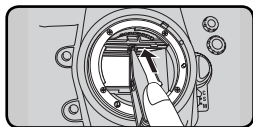
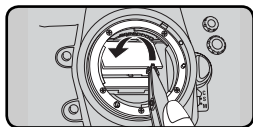
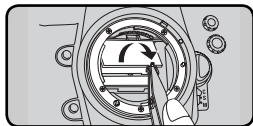
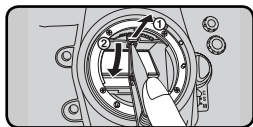
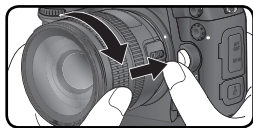

### ✓ Replacing Focusing Screens

Do not touch the surface of the mirror or focusing screens.

### ✓ Focusing Screens

Use only screens designated for use in the D2X or D2H.

### ✎ Framing Grids

The display in type V and E focusing screens may be slightly out of position depending on how the focusing screen is placed.





## Replacing the Clock Battery

The camera clock is powered by a CR1616 lithium battery with a life of about four years. If the **CLOCK** icon is displayed in the top control panel while the exposure meters are on, the battery is running low and needs to be replaced. When the battery is exhausted, the **CLOCK** icon will blink while the exposure meters are on. Photographs can still be taken but will not be stamped with the correct time and date, and interval timer photography will not function correctly. Replace the battery as described below.

- 1 The clock battery chamber is located on the roof of the main battery chamber. Turn the camera off and remove the EN-EL4 battery.
- 2 Slide the clock battery chamber cover toward the front of the main battery chamber.
- 3 Remove the clock battery.
- 4 Insert new CR1616 lithium battery so that the positive side (the side marked with “+” and the battery name) is visible.
- 5 Slide the clock battery chamber cover towards the back of the main battery chamber until it clicks into place.
- 6 Reinsert the EN-EL4.
- 7 Set the camera to the current date and time. Until the date and time have been set, the icon will flash in the top control panel.

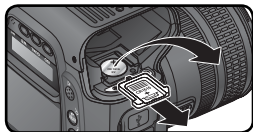

### CAUTION

Use only CR1616 lithium batteries. Using another type of battery could cause an explosion. Dispose of used batteries as directed.

### Inserting the Clock Battery

Insert the clock battery in the correct orientation. Inserting the battery incorrectly could not only prevent the clock from functioning but could damage the camera.

## The Low-Pass Filter

The image sensor that acts as the camera's picture element is fitted with a low-pass filter to prevent moiré. Although this filter prevents foreign objects from adhering directly to the image sensor, under certain conditions dirt or dust on the filter may appear in photographs. If you suspect that dirt or dust inside the camera is affecting your photographs, you can check for the presence of foreign objects on the low-pass filter as described below.

- 1 Turn the camera off and connect an EH-6 AC adapter (available separately). If you do not have access to an EH-6 AC adapter, take the camera to a Nikon-authorized service center.
- 2 Remove the lens and turn the camera on.
- 3 Press the **MENU** button and select **Mirror lock-up** from the setup menu (p. 206). The message shown at right will be displayed.

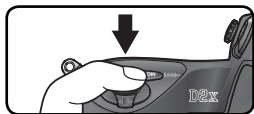
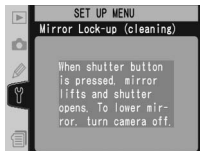

- 4 Press the multi selector to the right. The message shown at right will be displayed in the camera monitor, and a row of dashes will be displayed in the control panel and viewfinder. To return to normal operation without raising the mirror, turn the camera off. Mirror lock-up will also be cancelled if the monitor is allowed to turn off automatically.

- 5 Press the shutter-release button all the way down. The mirror will be raised and the shutter curtain will open, revealing the low-pass filter, and the row of dashes in the control panel will blink. The displays in the viewfinder and rear control panel will turn off.



- 6 Holding the camera so that light falls on the low-pass filter, examine the filter for dust or lint. If there are foreign objects on the filter, the filter requires cleaning. See the following section.

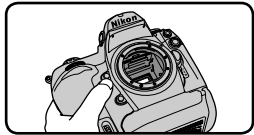

- 7 Turn the camera off. The mirror will return to the down position and the shutter curtain will close. Replace the lens or body cap and disconnect the AC adapter.

### *Cleaning the Low-Pass Filter*

The low-pass filter is extremely delicate and easily damaged. Nikon recommends that filter be cleaned only by Nikon-authorized service personnel. Should you choose to clean the filter yourself, follow the steps below.

- 1 Raise the mirror as described in steps 1–5 on the preceding page.

- 2 Remove dust and lint from the filter with a blower. Do not use a blower-brush, as the bristles could damage the filter. Dirt that can not be removed with a blower can only be removed by Nikon-authorized service personnel. Under no circumstances should you touch or wipe the filter.

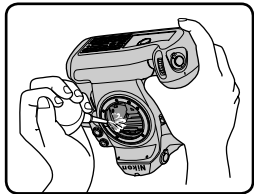

- 3 Turn the camera off. The mirror will return to the down position and the shutter curtain will close. Replace the lens or body cap and disconnect the AC adapter.









### **✓ Servicing the Camera and Accessories**

The D2X is a precision device and requires regular servicing. Nikon recommends that the camera be inspected by the original retailer or Nikon service representative once every one to two years, and that it be serviced once every three to five years (note that fees apply to these services). Frequent inspection and servicing are particularly recommended if the camera is used professionally. Any accessories regularly used with the camera, such as lenses or optional Speedlights, should be included when the camera is inspected or serviced.

# Troubleshooting

## Understanding Error Messages and Displays



This section lists the indicators and error messages that appear in the viewfinder, control panel, and monitor when there is a problem with the camera. Consult the list below before contacting your retailer or Nikon representative.

Indicator		Problem	Solution	
Control panel	Viewfinder			
<b>fE E</b> (blinks)		Lens aperture ring is not set to minimum aperture.	Set ring to minimum aperture (largest f/-number).	20
		Low battery.	Ready a fully-charged spare battery.	27
 (blinks)	 (blinks)	Battery exhausted.	Replace battery.	27
 (blinks)	 (blinks)	Battery can not be used.	Contact Nikon-authorized service representative.	27
<b>ΔF</b>		No lens attached, or non-CPU lens attached without specifying maximum aperture. Aperture shown in stops from maximum aperture.	Aperture value will be displayed if maximum aperture is specified.	130
	 (blinks)	Camera unable to focus using autofocus.	Focus manually.	83
<b>H I</b>		Subject too bright; photo will be overexposed.	<ul style="list-style-type: none"> <li>• Choose a lower sensitivity (ISO equivalency)</li> <li>• Use optional ND filter</li> <li>• In exposure mode:                             <ul style="list-style-type: none"> <li>S Increase shutter speed</li> <li>A Choose a smaller aperture (larger f/-number)</li> </ul> </li> </ul>	52 245 88 90
<b>L o</b>		Subject too dark; photo will be underexposed.	<ul style="list-style-type: none"> <li>• Choose a higher sensitivity (ISO equivalency)</li> <li>• Use optional Speedlight</li> <li>• In exposure mode:                             <ul style="list-style-type: none"> <li>S Lower shutter speed</li> <li>A Choose a larger aperture (smaller f/-number)</li> </ul> </li> </ul>	52 106 88 90



Indicator		Problem	Solution	
Control panel	Viewfinder			
		selected in shutter-priority auto.	Change shutter speed or select manual exposure mode.	88, 92
		Speedlight that does not support D-TTL flash control attached and set to TTL.	Change flash mode setting on optional Speedlight.	110
		Speedlight that does not support red-eye reduction attached and flash sync mode set to red-eye reduction.	Change flash sync mode or use Speedlight that supports red-eye reduction.	110–112
		If indicator blinks for 3s after flash fires, photo may be underexposed.	Check photo in monitor; if underexposed, adjust settings and try again.	116
<i>Err</i>		Camera malfunction.	Release shutter. If error persists or appears frequently, consult with Nikon-authorized service representative.	2
		Memory insufficient to record further photos at current settings, or camera has run out of file or folder numbers.	<ul style="list-style-type: none"> <li>• Reduce quality or size.</li> <li>• Delete photographs.</li> <li>• Insert new memory card.</li> </ul>	45 154 22

Indicator		Problem	Solution	
Monitor	Control panel			
NO CARD PRESENT		Camera cannot detect memory card.	Turn camera off and confirm that card is correctly inserted.	22
CARD IS NOT FORMATTED	<i>For</i>	Memory card has not been formatted for use in D2X.	Format memory card.	23, 210

Indicator		Problem	Solution	
Monitor	Control panel			
THIS CARD CANNOT BE USED	 (blinks)	<ul style="list-style-type: none"> <li>• Error accessing memory card.</li> <li>• Unable to create new folder.</li> <li>• Card has not been formatted for use in D2X.</li> </ul>	<ul style="list-style-type: none"> <li>• Use Nikon-approved card.</li> <li>• Check that contacts are clean. If card is damaged, contact retailer or Nikon representative.</li> <li>• Delete files or insert new memory card.</li> <li>• Format memory card.</li> </ul>	248 2  22, 154 23, 210
FOLDER CONTAINS NO IMAGES		No images on memory card or folder(s) selected for playback contain no images.	Select folder containing images from <b>Playback folder</b> menu or insert different memory card.	22, 156
ALL IMAGES HIDDEN		All photos in current folder are hidden.	No images can be played back until another folder has been selected or <b>Hide image</b> used to allow at least one image to be displayed.	156, 159
FILE DOES NOT CONTAIN IMAGE DATA		File has been created or modified using a computer or different make of camera, or file is corrupt.	Delete file or reformat memory card.	23, 154, 210

### A Note on Electronically-Controlled Cameras

In extremely rare instances, unusual characters may appear in the control panel and the camera may stop functioning. In most cases, this phenomenon is caused by a strong external static charge. Turn the camera off, remove and replace the battery, and turn the camera on again, or, if you are using an AC adapter (available separately), disconnect and reconnect the adapter and turn the camera on again. In the event of continued malfunction, contact your retailer or Nikon representative. Note that disconnecting the power source as described above may result in loss of any data not recorded to the memory card at the time the problem occurred. Data already recorded to the card will not be affected.

# Specifications



Type	Single-lens reflex digital camera with interchangeable lenses
Effective pixels	12.4 million
Image sensor	23.7 × 15.7 mm; total pixels: 12.84 million
Image size (pixels)	4288 × 2848 (L), 3216 × 2136 (M), 2144 × 1424 (S)
High-speed crop on	3216 × 2136 (L), 2400 × 1600 (M), 1600 × 1064 (S)
Lens mount	Nikon F mount (with AF coupling and AF contacts)
Compatible lenses*	
Type G or D AF Nikkor	All functions supported
Micro Nikkor 85 mm F2.8D	All functions supported except autofocus and some exposure modes
Other AF Nikkor†	All functions supported except 3D color matrix metering and 3D multi-sensor balanced fill-flash for digital SLR
AI-P Nikkor	All functions supported except 3D color matrix metering, 3D multi-sensor balanced fill-flash for digital SLR, and autofocus
Non-CPU	Can be used in exposure modes A and M; electronic range finder can be used if maximum aperture is f/5.6 or faster; color matrix metering, multi-sensor balanced fill-flash for digital SLR, and aperture value display supported if user provides lens data

\* IX Nikkor lenses can not be used

† Excluding lenses for F3AF

Picture angle	Equivalent in 35-mm format is approximately 1.5 times lens focal length (2 times when high-speed crop is on)
Viewfinder	Optical fixed eye-level pentaprism
Diopter adjustment	-3 to +1 m <sup>-1</sup>
Eyepoint	19.9 mm (-1.0 m <sup>-1</sup> )
Focusing screen	Ships with type V clear-matte Mark III screen installed
Frame coverage	Approximately 100% of lens (vertical and horizontal)
Magnification	Approximately 0.86x (50-mm lens at infinity; -1.0 m <sup>-1</sup> )
Reflex mirror	Quick return
Lens aperture	Instant return with depth-of-field preview
Focus-area selection	Single area or group can be selected from 11 focus areas (9 focus areas when high-speed crop is on)
Lens servo	Instant single-servo AF (S); continuous-servo AF (C); manual (M); predictive focus tracking automatically activated according to subject status in single- and continuous-servo AF

<b>Autofocus</b>	TTL phase detection by Nikon Multi-CAM2000 autofocus module
<b>Detection range (ISO 100 at 20 °C/68 °F)</b>	-1–+19EV (0–+19EV for two focus areas outside high-speed crop)
<b>AF-area mode</b>	Single-area AF, dynamic-area AF, group dynamic-AF, dynamic-area AF with closest subject priority
<b>Focus lock</b>	Focus can be locked by pressing shutter-release button half-way (single-servo AF) or by pressing <b>AE-L/AF-L</b> button
<b>Exposure</b>	
<b>Metering</b>	Three-mode through-the-lens (TTL) exposure metering
<b>Matrix</b>	3D color matrix metering supported with type G and D lenses; color matrix metering available with other CPU lenses and with non-CPU lenses if user provides lens data
<b>Center-weighted</b>	Weight of 75% given to 6, 8, 10, or 13-mm circle in center of frame, or weighting based on average of entire frame
<b>Spot</b>	Meters 3-mm circle (about 2% of frame) centered on selected focus area (on center focus area when non-CPU lens is used)
<b>Range (ISO 100 equivalent, f/1.4 lens, 20 °C/68 °F)</b>	0–20EV (3D color matrix or center-weighted metering) 2–20EV (spot metering)
<b>Exposure meter coupling</b>	Combined CPU and AI
<b>Exposure control</b>	
<b>Exposure modes</b>	Programmed auto with flexible program; shutter-priority auto; aperture priority auto; manual
<b>Exposure compensation</b>	-5–+5EV in increments of 1/3, 1/2, or 1EV
<b>Bracketing</b>	Exposure and/or flash bracketing (2–9 exposures in increments of 1/3, 1/2, 2/3, or 1EV)
<b>Exposure lock</b>	Luminosity locked at detected value with <b>AE-L/AF-L</b> button
<b>Shutter</b>	
<b>Speed</b>	30–1/8000 s in steps of 1/3, 1/2, or 1EV, bulb
<b>Sensitivity (ISO equivalent)</b>	100–800 in steps of 1/3, 1/2, or 1EV, 1600, 3200; auto gain to 800
<b>White balance</b>	Auto (TTL white-balance with main image sensor, 1,005 pixels RGB sensor, and ambient light sensor), six manual modes with fine-tuning, color temperature setting
<b>Bracketing</b>	2–9 exposures in increments of 1, 2, or 3





<b>Flash</b>	
Sync contact	X-contact only; flash synchronization at up to 1/250s
<b>Flash control</b>	
TTL	TTL flash control by combined five-segment TTL multi sensor with single-component IC and 1,005-pixel AE sensor <ul style="list-style-type: none"> <li>• <b>SB-800, 600:</b> i-TTL balanced fill-flash for digital SLR and standard i-TTL flash for digital SLR</li> <li>• <b>SB-80DX, 28DX, or 50DX with type G or D lens:</b> 3D multi-sensor balanced-fill flash for digital SLR</li> <li>• <b>SB-80DX, 28DX, or 50DX with other lens:</b> multi-sensor balanced-fill flash for digital SLR</li> <li>• <b>SB-80DX, 28DX, or 50DX with spot metering:</b> standard TTL flash for digital SLR</li> </ul>
Auto aperture	Available with SB-800, 80DX, or 28DX and CPU lens
Non-TTL auto	Available with such Speedlights as SB-800, 28, 27, and 22s
Range-priority manual	Available with SB-800
Sync modes	Front curtain sync (normal), slow sync, rear-curtain sync, red-eye reduction, red-eye reduction with slow sync
Flash-ready indicator	Lights when SB-series Speedlight such as 800, 600, 80DX, 28DX, 50DX, 28, 27, or 22s is fully charged; blinks for 3s after flash is fired at full output
Accessory shoe	Standard ISO hot-shoe contact with safety lock
Creative Lighting System	With SB-800 and 600, supports Advanced Wireless Lighting (SB-600 only supports AWL when used as remote flash), Auto FP High-Speed Sync, Flash Color Information Communication, modeling illumination, and FV Lock
<b>Storage</b>	
Media	Type I and II CompactFlash memory cards; Microdrives
File system	Compliant with Design Rule for Camera File System (DCF) and Digital Print Order Format (DPOF)
Compression	<ul style="list-style-type: none"> <li>• <b>Compressed 12-bit NEF (RAW):</b> approximately 50–60%</li> <li>• <b>JPEG:</b> JPEG baseline-compliant, can be selected from <b>Size priority</b> and <b>Optimal quality</b></li> </ul>
Self-timer	Electronically controlled timer with 2–20s duration
Depth-of-field preview	Lens aperture stopped down when depth-of-field preview button is pressed
Monitor	2.5", 232,000-dot, low-temperature polysilicon TFT LCD with brightness adjustment

<b>Video output</b>	Can be selected from NTSC and PAL
<b>External interface</b>	USB 2.0
<b>Tripod socket</b>	¼" (ISO)
<b>Firmware</b>	User upgradeable
<b>Supported languages</b>	Chinese (Simplified), Dutch, English, French, German, Italian, Japanese, Korean, Spanish, Swedish
<b>Power source</b>	<ul style="list-style-type: none"><li>• One 11.1 V EN-EL4 rechargeable Li-ion battery</li><li>• EH-6 AC adapter (available separately)</li></ul>
<b>Dimensions (W × H × D)</b>	Approximately 157.5 × 149.5 × 85.5 mm (6.2" × 5.9" × 3.4")
<b>Weight</b>	Approximately 1070 g (2 lb 6 oz) without battery, memory card, body cap, or monitor cover
<b>Operating environment</b>	
<b>Temperature</b>	0–40 °C (32–104 °F)
<b>Humidity</b>	Less than 85% (no condensation)

- Unless otherwise stated, all figures are for a camera with a fully-charged battery operating at an ambient temperature of 20 °C (68 °F).
- Nikon reserves the right to change the specifications of the hardware and software described in this manual at any time and without prior notice. Nikon will not be held liable for damages that may result from any mistakes that this manual may contain.

## Battery Life

The number of shots that can be taken with an EN-EL4 battery varies with the condition of the battery, temperature, and how the camera is used.

### Case 1

At room temperature (20°C/68°F), approximately 2600 shots can be taken with a fully-charged (1900mAh) EN-EL4 battery and an AF-S VR 70–200 mm f/2.8G IF ED lens (VR off) under the following standard Nikon test conditions: continuous high-speed shooting mode; high-speed crop mode off; continuous-servo autofocus; image quality set to JPEG Normal; image size set to Large; shutter speed  $\frac{1}{250}$ s; shutter-release pressed halfway for three seconds and focus cycled from infinity to minimum range three times; after six shots, monitor turned on for five seconds and then turned off; cycle repeated once exposure meters have turned off.

### Case 2

At room temperature (20°C/68°F), approximately 850 shots can be taken with a fully-charged (1900mAh) EN-EL4 battery and an AF-S VR 24–120 mm f/3.5–5.6G IF ED lens (VR off) under the following standard Nikon test conditions: single-frame shooting mode; high-speed crop mode off; single-servo autofocus; image quality set to JPEG Normal; image size set to Large; shutter speed  $\frac{1}{250}$ s; shutter-release pressed halfway for six seconds and focus cycled from infinity to minimum range once with each shot; after each shot, monitor turned on for two seconds and then turned off; cycle repeated once exposure meters have turned off.

The following can reduce battery life:

- Using the monitor
- Keeping the shutter-release button pressed halfway
- Repeated autofocus operations
- Taking NEF (RAW) or TIFF (RGB) photographs
- Slow shutter speeds
- Using optional WT-2/2A or WT-1/1A wireless transmitters

To ensure that you get the most from rechargeable Nikon EN-EL4 batteries:

- Keep the battery contacts clean. Soiled contacts can reduce battery performance.
- Use batteries immediately after charging. Batteries will lose their charge if left unused.

**Menus****▶ PLAYBACK MENU (154–165)**

Delete, 154–155

Playback folder, 156

Slide show, 157–158

Hide image, 159–160

Print set, 161–163

Display mode, 164

Image review, 164

After delete, 165

Rotate tall, 165

**▶ SHOOTING MENU (166–175)**Shooting menu bank,  
167–168

Reset shooting menu, 169

Active folder, 170

File Naming, 171

Image quality, 45–46

Image size, 48–49

Hi-speed Crop, 41–42

JPEG compression, 47

Raw compression, 48

White bal., 54–66

Long exp. NR, 173

High ISO NR, 173

ISO, 52–53

Image sharpening, 67

Tone compensation, 68

Color space, 69

Color mode, 70

Hue adjustment, 71

Image Overlay, 117–118

Multiple exposure,  
119–121Intvl timer shooting,  
122–126Non-CPU lens data,  
128–131**▶ CSM MENU (176–208)****C:** Bank select, 179**R:** Menu reset, 180–181**a1:** AF-C mode priority,  
182**a2:** AF-S mode priority,  
182**a3:** Group dynamic AF,  
183–184**a4:** Lock-On, 185**a5:** AF activation, 185**a6:** Focus area illum, 186**a7:** Focus area, 187**a8:** Vertical AF-ON, 187**b1:** ISO auto, 188**b2:** ISO step value, 189**b3:** EV step, 189**b4:** Exposure comp. EV,  
189**b5:** Exposure comp., 190**b6:** Center weight, 191**b7:** Fine-tune exposure,  
191**c1:** AE Lock, 192**c2:** AE-L/AF-L, 192**c3:** Auto meter-off, 193**c4:** Self-timer, 193**c5:** Monitor off, 193**d1:** Shooting speed, 194**d2:** Maximum shots,  
194–195**d3:** Exp. delay mode, 195**d4:** File No. Seq., 196**d5:** Cntrl panel/finder,  
196–197**d6:** Illumination, 197**e1:** Flash sync speed, 198**e2:** Flash shutter speed,  
198**e3:** AA flash mode, 199**e4:** Modeling flash, 199**e5:** Auto BKT set, 200**e6:** Manual mode bking,  
201**e7:** Auto BKT Order, 201**e8:** Auto BKT selection,  
202**f1:** Center button, 202–203**f2:** Multi selector, 204**f3:** Photo Info/Playback,  
204**f4:** FUNC. button, 205**f5:** Command dials,  
206–207**f6:** Buttons and dials, 208**f7:** No CF card?, 208**Y SET UP (209–227)**

Format, 210

LCD brightness, 211

Mirror lock-up, 211

Video mode, 212

World Time, 18

Language, 17

Image comment, 213

Auto image rotation, 214

Voice memo, 148

Voice memo overwrite,  
149

Voice memo button, 149

Audio output, 151

USB, 216

Dust Off ref photo,  
217–218

Battery info, 219

Wireless LAN, 219–227

Firmware version, 227

**Symbols**

3D color matrix metering II.

See Metering

3D Multi Sensor Balanced Fill-Flash for Digital SLR, 108

**A**

Advanced Wireless Lighting, 109

AF-area mode, 76

Aperture, 85–94

adjusting, 90

lock, 94

maximum, 84, 91, 93, 107,  
108, 128

minimum, 20, 85

non-CPU lenses and, 128  
value display, 7, 11

Ambient light sensor, 54, 59

Auto meter off, 193

Autoexposure lock, 95

Autofocus, 76

continuous-servo, 72

focus tracking, 73

single-area AF, 76

single-servo, 72

Auto FP high-speed sync,  
109, 245

AV OUT, 151, 230

- B**  
 Backlight, control panel, 3  
 BASIC. See Image quality  
 Battery,  
   inserting, 16  
   life, 261  
   storage, v  
 Blur, reducing, 33, 52–53,  
 88. See also Exposure delay  
 mode; Mirror-up mode 43,  
 195  
 Bulb. See Long time exposures  
 Bracketing, 98–105. See also  
 Exposure bracketing; White  
 balance, bracketing  
 Brightness. See Monitor, bright-  
 ness of
- C**  
 C. See Autofocus, continu-  
 ous-servo  
 Ch. See Shooting mode  
 Cl. See Shooting mode  
 Clock-calendar, 19  
 Closest subject priority. See  
 AF-area mode  
 Color profile. See **SHOOT-  
 ING MENU, Color space**  
 Color temperature. See White  
 balance  
 CompactFlash. See Memory  
 card  
 Computer, 216–231  
 Continuous shooting mode,  
 43, 194  
 Contrast. See **SHOOTING  
 MENU, Tone compensation**  
 CPU lenses, 20, 240–242  
 Creative Lighting System, 106  
 Custom Settings, 176  
   defaults, 180  
   menu banks, 179  
 CSM. See **CSM MENU**;  
 Custom Settings
- D**  
 Daylight saving time, 18  
 DCF version 2.0. See Design  
 rule for Camera File system  
 Deleting, 35, 144, 154–155.  
 See also Memory card,  
 formatting  
   all images, 155  
   playback menu, 154  
   selected images, 155  
   single-frame playback, 35,  
   136  
 Depth-of-field preview, 85  
 Design rule for Camera File  
 system, 156  
 Digital Print Order Format,  
 161  
 Diopter, 31, 244  
 DPOF. See Digital Print Order  
 Format  
 D-TTL flash control, 108
- E**  
 Electronic analog exposure  
 display, 93  
 Electronic range finder, 83  
 Exif version 2.21, 163  
 Exposure bracketing, 98  
 Exposure compensation, 97  
 Exposure delay mode, 195  
 Exposure meters, 84. See also  
 Auto meter off  
 Exposure mode, 85–93  
   aperture-priority auto, 90–91  
   manual, 92–93  
   programmed auto, 86–87  
   shutter-priority auto, 88–89
- F**  
 FINE. See Image quality  
 Flash, 106–116. See also  
 Speedlight  
   bracketing, 98  
 Flash Color Information Com-  
 munication, 54  
 Flash-ready indicator, 116  
 Flash sync mode, 112  
 Flexible program, 87. See  
 also Exposure mode, pro-  
 grammed auto  
 Focal plane mark, 3, 83  
 Focus. See autofocus; focus  
 mode; manual focus  
 Focus area (focus brackets),  
 10, 74–79  
 Focus lock, 80  
 Focus mode, 72–73  
 Focusing screen, 244, 250  
   type B BriteView III, 244  
   type E clear matte III, 244  
   type V clear matte III, 244  
 Folders, 156, 170, 196, 236  
 FV lock, 114, 205
- G**  
 GPS, 132  
   data, 138  
 Group dynamic-AF. See AF-  
 area mode
- H**  
 HI-1/HI-2, 52–53  
 Highlight display, 139, 164  
 High-speed crop, 41–42  
   in viewfinder, 10–11  
   mode, 41–42  
 Histogram, 138, 164  
   RGB, 139, 164
- I**  
 Illuminator. See Backlight,  
 control panel  
 Image dust off, 217–218  
 Image files, 47, 50–51, 196  
 Image overlay, 117–118  
 Image sensor, 252, 257  
 Image size, 48–49  
 Image quality, 45–48  
 ISO. See Sensitivity  
 ISO auto, 188  
 i-TTL flash control, 107
- J**  
 JPEG, 45–47
- L**  
 L. See Image size  
 Lens, 20–21, 240–242  
   attaching, 20  
   compatible, 240–241  
   CPU, 20, 240–242  
   non-CPU, 240–241  
   type D, 20, 240, 242  
   type G, 20, 240, 242

Long time-exposures, 92

Low-pass filter, 252–253

## M

M. See Exposure mode, manual; Manual focus; Image size

Manual focus, 83

Memory buffer, 43–44, 50

Memory card, 22–24

approved, 248

capacity of, 50–51

formatting, 23, 210

Metering, 84

3D color matrix, 84

center-weighted, 84

color matrix, 84

spot, 84

Microdrive. See memory card

Mirror up. See Shooting mode

Monitor, 5, 249

auto off, 193

brightness of, 211

cover, 28

Monitor pre-flashes, 107,

108, 114

Multiple exposures, 119–121

Multi Sensor Balanced Fill-

Flash for Digital SLR, 108

M-up. See Shooting mode

## N

NEF, 41–44

Nikon Capture 4, 45–50, 217

Noise, 45, 231–232, 246

reduction, 173

high sensitivities, 53

slow shutter speeds, 92

NORMAL. See Image quality

## P

PictBridge. See Printing

photographs

PictureProject, 45, 231–232

Picture Transfer Protocol. See PTP.

Photo information, 137–139

Playback, 35, 136

Playback menu, 154–165

PRE. See White balance, preset

Predictive focus tracking, 73

Printing photographs,

234–238. See also Digital

Print Order Format

Protecting images, 143

PTP, 216, 231, 234

## R

RAW, 45–50, 117, 217. See

also Image quality; NEF

Recent Settings, 39

Red-eye reduction, 110–113

## S

S. See Autofocus, single-

servo; Exposure mode, shutter-

priority auto; Image size;

Shooting mode

Self-portraits. See Self-timer

Self-timer, 120, 193

Sensitivity, 52–53. See also 

### SHOOTING MENU, ISO

Sequential file numbering, 196

Setup menu, 209–227

Shutter speed, 85–94

and flash synchronization,

111, 198

Shooting menu, 166–175

banks, 167–168

Shooting mode, 43–44

Single-frame. See Shooting mode

Single-frame playback, 35,

136–139

Size. See Image size

Speedlight, 106–116,

198–199, 245–246. See also

flash compatible, 109–111

sRGB. See  SHOOTING

### MENU, Color space

Standard TTL Flash for Digital

SLR, 108

## T

Television, 230

TIFF-RGB. See Image quality

Time. See **Y SET UP, World**

### Time

Time exposures. See Long time-exposures

Time zone. See **Y SET UP,**

### World Time

Thumbnail playback, 140–141

Two-button reset, 133

## U

USB, 216, 231, 234. See also computer

## V

Video device, 212, 230

Viewfinder, 10, 31

focus. See Diopter

## W

White balance, 54–66

bracketing, 103–105

color temperature, 58

fine-tuning, 56–57

preset, 59–66

Wireless networks, 220–227

# **Nikon**

No reproduction in any form of this manual, in whole or in part (except for brief quotation in critical articles or reviews), may be made without written authorization from NIKON CORPORATION.