

Mamiya

RB67^{PRO}SD



Instructions

Congratulations on your wise decision to purchase the Mamiya RB 67 Professional SD (Pro-SD)

The RB67 Pro-SD is the latest addition to the long-selling RB67 Series which was first released in 1970. Due to its innovative 6x7cm revolving back format, the RB67 has been highly recognized throughout the world as the genesis of the medium format cameras.

Specifically, the camera features an expanded interval lens mount diameter (from 54mm to 61mm, i.e. the same as that of the RZ67), thereby enabling a wider variety of new, high performance lenses, such as the APO series to be used. The newly developed extra bright, ultra low dispersion glass of the APO series lenses and shift lens have gone a long way to improving system configuration.

With a wide spectrum of accessories, photographic excellence is assured in a multitude of applications from commercial to portraiture.

Perusing this manual before attempting to use the Pro-SD will minimize the possibility of malfunctions.

1	Features of the Mamiya RB67 Pro-SD	2
2	Parts and How to Operate	3
3	Specifications	8
4	Attaching and Removing the Lens	9
5	Waist-level Finder Operation	10
6	Shutter Operation	13
7	Attaching and Detaching the Roll Film Holder	14
8	Releasing the Shutter	16
9	Loading the Film Holder	17
10	Operating the Revolving Adapter	20
11	Setting the Shutter Speed and the Aperture	21
12	Focusing and Focusing Knob Fixing	22
13	Taking Photographs	23
14	Testing the Shutter When the Film is Loaded	261
15	Unloading the Film	26
16	Distance Scale	27
17	Depth-of-field	27
18	Time (T) exposures • Flash Photography	28
19	Changing the Focusing Screen	29
20	Mirror Lock-up Photography	30
21	Multiple Exposure Photography	32
22	Close-up Photography	32
23	How to use the Carrying Strap	35
24	Back Locking System	36
25	Lens Mount Adapter Ring	37
26	Trouble Shooting	40
27	Camera Storage and Maintenance	41

1. Features of the Mamiya RB67 Pro-SD

Practical 6x7cm

Since 6x7cm format covers an area 4.5 times the 35mm format, excellent picture quality is assured. In color photography, in particular, it demonstrates superior results. The ratio between the length and width of the 6x7cm format is almost the same as that of large sized printing paper, permitting economical enlargements without cropping.

The revolving adapter allows quick changeover from the vertical or horizontal format

By simply turning the revolving adapter 90°, either a vertical or horizontal format can be selected without moving the camera. Proper picture composition is easily determined by index finder lines interlocked with the revolving adapter.

Bright, parallax-free finder

With the lens aperture open, the subject appearing on the large, bright focusing screen assures speedy focusing and composing. The parallax-free single-lens reflex Pro-SD thus is ideal for instantaneous photos where the utmost in quality is required.

The Pro-SD roll film holders assure excellent film flatness

The Pro-SD roll film holders are designed with the utmost consideration given to film flatness and also feature an interlocked multiple exposure prevention system.

The newly designed dark slide slot accepts the dark slide from either the left or right side.

The 6x8 cm format now possible

The Pro-SD body back is designed to permit 6x8cm photography, thus expanding the photographic scope for studio work and in other fields that use 6x8cm.

Close-up photography through the full use of the bellows

Since the bellows can be extended up to 46mm photographing even the smallest subjects in frame full is possible. When auto extension tubes are used, the subject can be further enlarged. When a standard lens is employed, life-sized (1:1) reproductions are possible only with the tubes.

Excellent heat and cold resistance

The Pro-SD is mechanically advanced so that its components can function over a wide temperature range from approximately -20°C to -50°C.

Enlarged lens mount

Compared to the conventional RB67 Series, the Pro-SD has a lens mount with a diameter 7mm larger, making it possible to accept a new group of high performance sophisticated lenses, such as the APO, shift, and newly designed wide angle lens 75mm. Since the lenses are systematized, a lens suitable for desired composition can be selected. The new lenses are designed with emphasis on color contribution and feature a built-in bulb (B) unit, and the wide-angle lenses have a floating feature to assure improved close-up performance. All Pro-SD lenses use a lens shutter and an electronic flash synchronize for all shutter speeds.

Extensive variety of accessories and interchangeable film holders

Pro-SD accessories are interchangeable with those of the RB67 Series and are available in a diverse variety, thus satisfying every possible photographic need.

A wide variety of film holders are available: 6x7cm format 120/200 roll film holders and 6x4.5cm (semi-format) holders for the Pro-SD, as well as 6x7cm and 6x8cm power drive holders, 70mm holder and sheet film holders. All these assure high quality, sharp images over a large picture area.

2. Parts and How to Operate

Shutter cocking lever

The lever cocks both the shutter and the mirror. Unless they are set, a safety device prevents the shutter release button from being depressed.

Dark slide

When the dark slide is inserted, a safety device prevents the shutter release button from being depressed. (Take the dark slide out before taking a picture and put it into the storing lug.)

Mirror (Never touch it!)

Distance graduation

Focusing knob

Distance scale

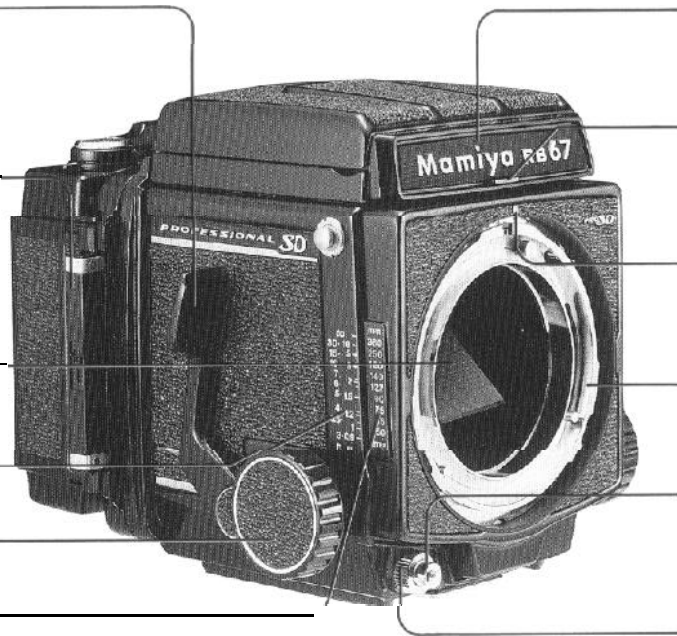

Nameplate

By sliding the nameplate, the focusing hood can be exchanged.

Finder latch

The latch prevents the finder from slipping off if the nameplate is carelessly move.

Lens mounting index mark (red dot)

Lens mount

Shutter release button

A safety device will prevent the shutter from being released if the camera is not completely ready for photography.

Shutter release lock ring

When index mark of the ring is aligned with the red dot, a safety device prevents the shutter release button from being depressed. (Align the index mark with the white dot before taking a picture.)

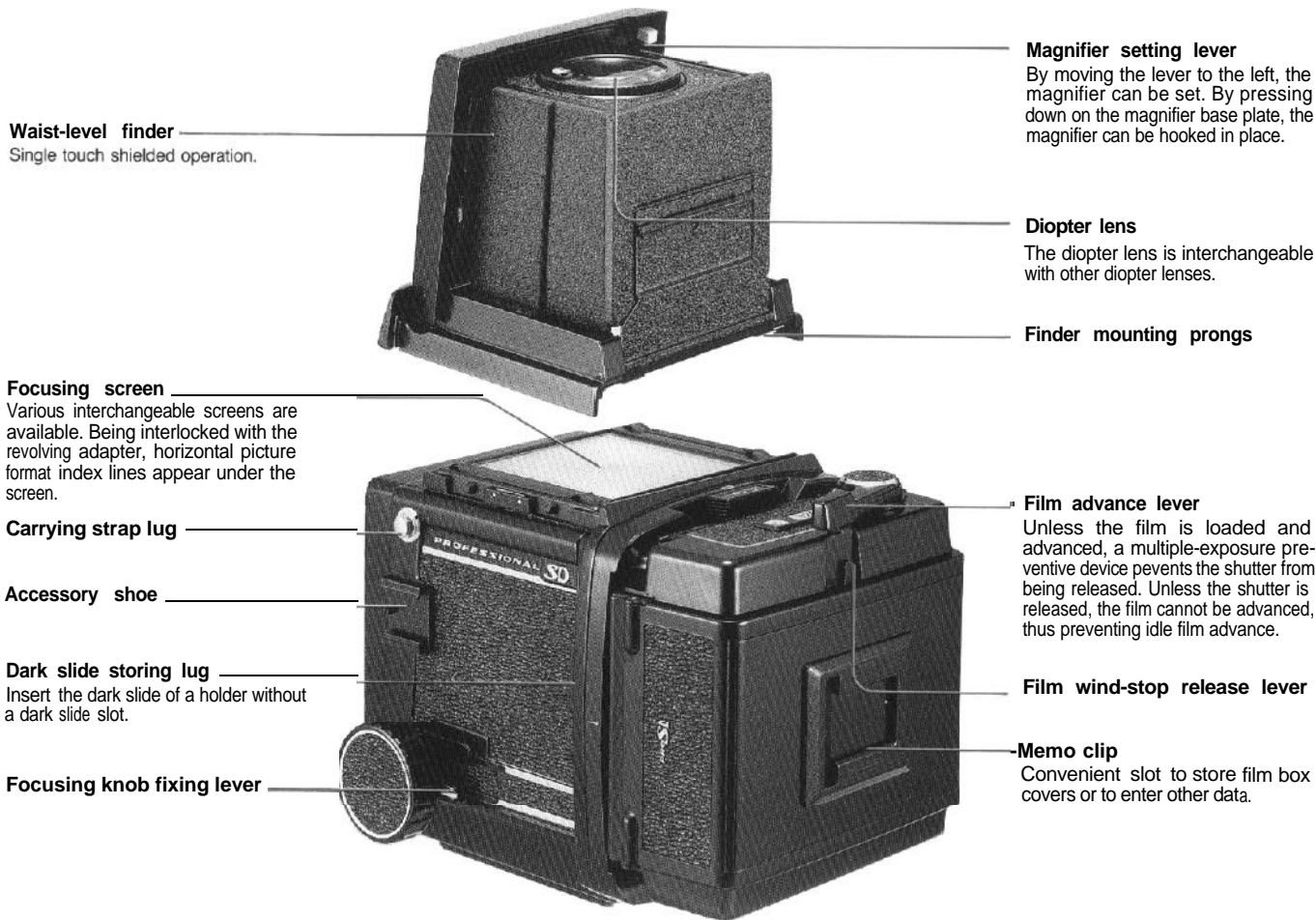

Waist-level finder
Single touch shielded operation.

Magnifier setting lever
By moving the lever to the left, the magnifier can be set. By pressing down on the magnifier base plate, the magnifier can be hooked in place.

Diopter lens
The diopter lens is interchangeable with other diopter lenses.

Finder mounting prongs

Focusing screen
Various interchangeable screens are available. Being interlocked with the revolving adapter, horizontal picture format index lines appear under the screen.

Carrying strap lug

Film advance lever
Unless the film is loaded and advanced, a multiple-exposure preventive device prevents the shutter from being released. Unless the shutter is released, the film cannot be advanced, thus preventing idle film advance.

Accessory shoe

Film wind-stop release lever

Dark slide storing lug
Insert the dark slide of a holder without a dark slide slot.

Memo clip
Convenient slot to store film box covers or to enter other data.

Focusing knob fixing lever

Coupling pin for film wind-stop release

When the shutter is released, the pin will automatically disengage film wind-stop allowing subsequent film advance.

Light baffle

DO NOT touch the baffle with your fingers!

Revolving adapter

Turning this adapter up to 90° permits change-over between the horizontal and vertical picture format.

R-lock lever

Use the lever to attach and detach the revolving adapter.

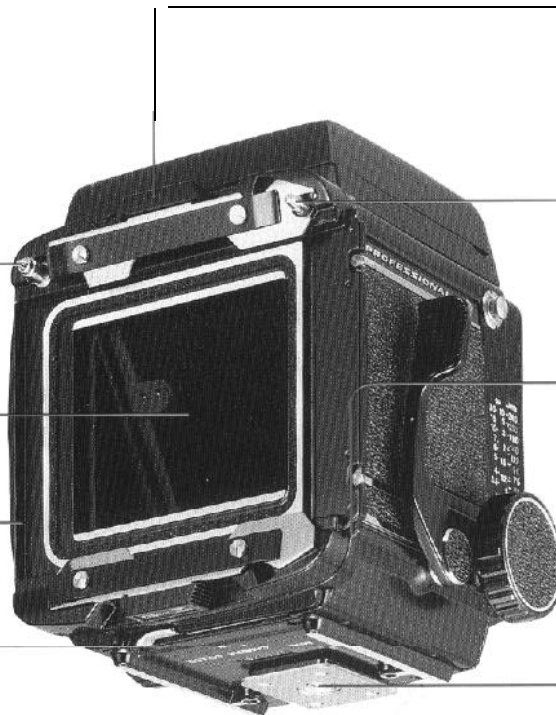

Slide lock for G-lock type holder

Use the lock to attach and detach film holders. When the dark slide is not inserted in the attached roll film holder, a safety device prevents the holder from being detached from the camera body.

Coupling pin for multi-exposure prevention

Release lever for slide lock

When detaching a film holder other than the roll film holder, or when the slide lock is locked, move the slide lock to the left while pressing this release lever.

Tripod socket

The socket fits to a U 1/4-inch tripod screw. By removing the inner socket, a tripod with a 3/8-inch tripod screw can be used.

**Synchroflash terminal
(X contact)**

Synchronized at all speeds.

Shutter speed ring

Bulb (B)

Used to close the shutter when the shutter speed dial has been set at T (time).

Depth-of-field preview lever

Bayonet ring

The bayonet ring clamps the lens to the body. When the mirror is not cocked, a safety device prevents the lens from being removed.

Cocking position marks

Mirror-up socket

Merely screwing a cable release into the mirror-up socket prepares the camera for mirror-up, giving vibration-free photography. Raise the mirror before-hand, then release the shutter just when taking a picture.



Aperture scale ring

Depth-of-field scale

Distance scale for depth-of-field reading

The ring is calibrated in both meters (m) and feet (ft).

Distance scale lever for depth-of-field reading



Shutter release lock pin

The shutter can be released by turning the shutter cocking pin clockwise while pressing the lock pin.

Shutter cocking pin

When cocking the shutter with a finger, turn the cocking pin to the red dot.

Lens mount adapter ring

By removing the KL lens adapter ring, use it with the RB series lens body. (When using with the Pro-SD, attach the adapter ring to its original position.)

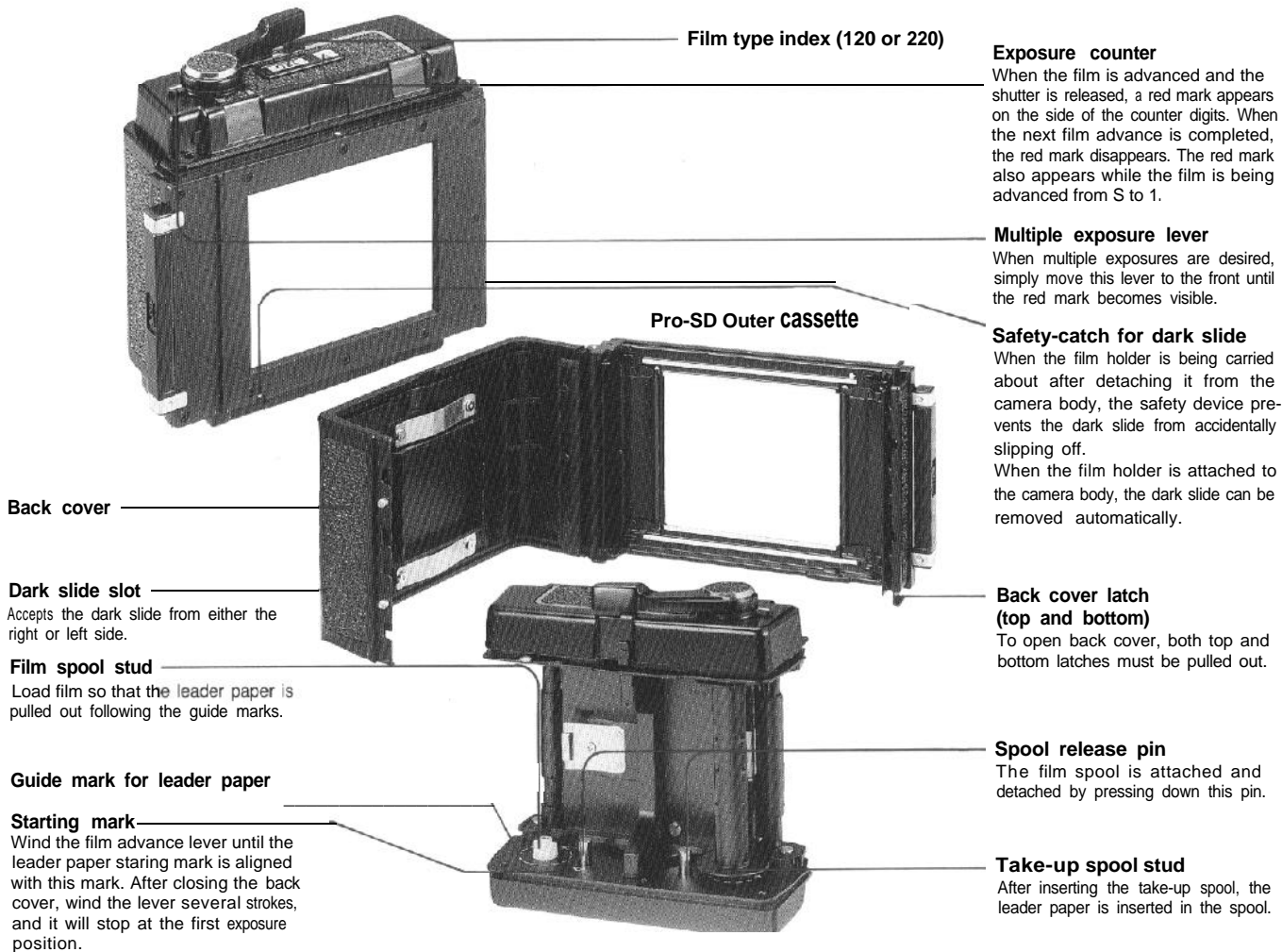

Film type index (120 or 220)

Exposure counter

When the film is advanced and the shutter is released, a red mark appears on the side of the counter digits. When the next film advance is completed, the red mark disappears. The red mark also appears while the film is being advanced from S to 1.

Multiple exposure lever

When multiple exposures are desired, simply move this lever to the front until the red mark becomes visible.

Pro-SD Outer Cassette

Safety-catch for dark slide

When the film holder is being carried about after detaching it from the camera body, the safety device prevents the dark slide from accidentally slipping off.

When the film holder is attached to the camera body, the dark slide can be removed automatically.

Back cover

Dark slide slot

Accepts the dark slide from either the right or left side.

Film spool stud

Load film so that the leader paper is pulled out following the guide marks.

Guide mark for leader paper

Starting mark

Wind the film advance lever until the leader paper starting mark is aligned with this mark. After closing the back cover, wind the lever several strokes, and it will stop at the first exposure position.

Back cover latch (top and bottom)

To open back cover, both top and bottom latches must be pulled out.

Spool release pin

The film spool is attached and detached by pressing down this pin.

Take-up spool stud

After inserting the take-up spool, the leader paper is inserted in the spool.

• Camera Body

Type:

6x7cm lens-shutter single-lens reflex camera: corresponding the 6x8cm format.

Lens mount:

With safety lock ring.

Viewfinder:

Horizontal format index mark interlocks with revolution of revolving adapter (Vertical format based on fixing index line on focusing screen) 96% of the field of view visible.

Waist-level finder:

Single-action opening and closing, with mounting lock.

Interchangeable.

Finder magnification is 3x. Interchangeable, diopter lens.

Focusing screen:

With fresnel lens. Interchangeable. (7 types)

Revolving adapter

Full 90° revolving rotary system; vertical horizontal format indicator interlocking mechanism.

By R-lock interchangeable system with Polaroid pack film holder, etc.

By G-lock revolving adapter system, G-lock-type film holders are attachable.

Focusing:

Bellows extension system with rack and pinions.

Maximum extension 46mm. With focusing knob fixing device.

Shutter and mirror cocking:

Single-action (75°) cocking by lever on the side of the body.

Additional features:

Accessory shoe is provided.

Shutter release button can be locked to prevent releasing the shutter accidentally.

• Standard Lenses:

Lens:

Mamiya KL 127mm f/3.5L with lens hood

Composition:

6 elements in 4 groups

Angle of view:

38°

Filter screw diameter:

77mm

Aperture:

Full automatic diaphragm (with depth-of-field preview lever). f/3.5 to 32 (with click-stops for aperture settings).

Shutter:

Seiko #1 shutter

1 to 1/400 second and T (Time)

Flash synchronization:

X contact

Other features:

Mirror-up photography. Bulb (B) feature.

• Pro-SD 120 Roll Film Holder

Film used:

120 roll film 10 exposures; 6x7cm format
Actual negative size: 56x69.5mm

Film advance:

One-stroke film advance lever (After winding 70° can be wound in several short, definite strokes).

Automatic multiple-exposure prevention.

Film wind-stop automatic release.

Multiple exposures are also an option.

Film counter:

Automatic reset; red index mark disappears upon completion of film winding

Features dark slide dislocation prevention, storing lug and memo clip.

• Dimensions:

(Camera body with roll film holder)

Height: 144mm

Width: 104mm

Length: 233mm (with 127mm f/3.5 lens)

• Weight:

Camera body	1050g
Revolving adapter	200g
Waist-level finder	185g
Pro-SD roll film holder . . .	475g
KL 127mm f/3.5L lens	780g
Total weight	2690g

4. Attaching and Removing the Lens

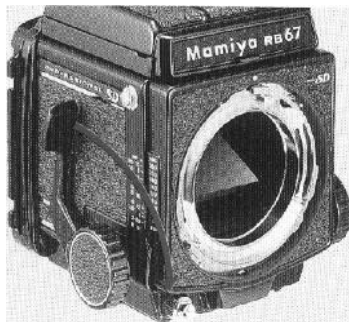

After cocking the mirror and the lens shutter, mount the lens on the camera body.

Cocking the mirror

1. Remove the front body cap from the camera body.
2. Be sure that the mirror is in the cocked, down position in the camera body, shielding the film plane from exposure to light.

If the mirror is up, cock the mirror by fully pushing down the shutter cocking lever toward the front of the camera.



Cocking the lens shutter

1. Remove the rear cap of the lens by turning the bayonet ring clockwise.
2. Cock the lens shutter. Firmly turn the shutter cocking pins with your fingers, to the red dots (A) of the cocking position,
 - If the cocking pins are not fully turned to the red dots (A), the shutter will not be completely cocked.
 - The shutter is always cocked on a lens that has been removed from the body.



Attaching the lens

1. Turn the bayonet ring counterclockwise, and align the white dot on the bayonet ring with the red mark at the center of the lens mount.
2. Mount the lens, keeping the red mark aligned with the red mark on the body; then firmly twist the bayonet ring clockwise. The camera and lens are now set.

NOTE:

Do not place the camera on its back without the rear body cap or film holder being in place. Otherwise the coupling mechanism may be damaged!

5. Waist-level Finder



Removing the lens

1. Set the mirror and cock the shutter by pushing the cocking lever as far as it will go toward the front of the camera body.
 2. Rotate the bayonet ring of the lens counter-clockwise as far as it will go (the white dot on the bayonet ring will align with the central red mark on the body) and remove the lens.
- If the mirror and the shutter are not cocked the safety interlock will interfere with the rotation of the bayonet ring and the lens cannot be removed.



Releasing the shutter on a lens which has been removed from the body

To release the shutter on a lens which has been removed from the camera body, turn the cocking pins (B) clockwise, while pressing the shutter lock pin (A) with a finger. The cocking pins should be turned all the way; do NOT leave the pins turned halfway.

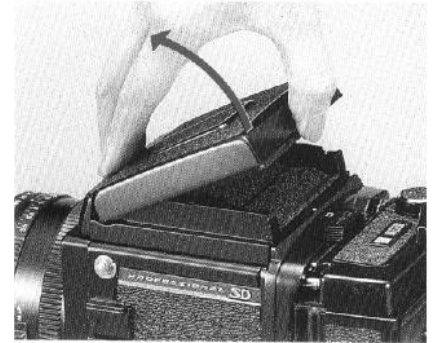

Raising the finder

Merely lift the back of the finder until it opens completely.

Operation

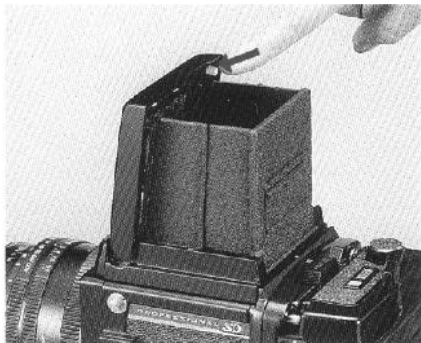

Raising the magnifier

Slide the magnifier release slightly to the left and the magnifier will pop up into position.

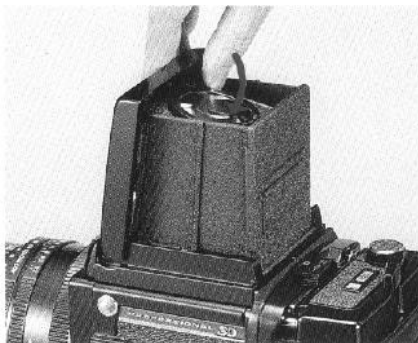

Lowering the magnifier

Gently push the base plate of the magnifier all the way down until it locks in place.

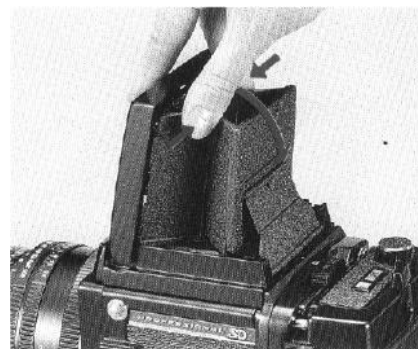

Folding the finder

After lowering the magnifier, gently squeeze the right and left panels of the finder together while closing it.

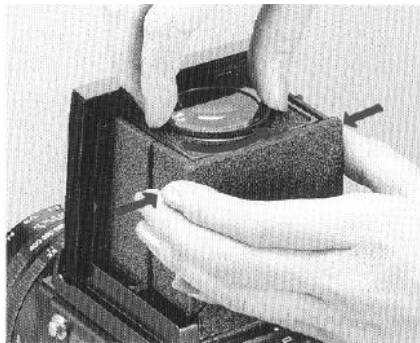

Changing the diopter lens

While holding the diopter lens base plate with both side panels of the finder, turn the diopter lens counterclockwise, and at the point where the white dot on the diopter lens aligns with the white dot on the base plate, remove the diopter lens.

To mount another diopter lens, simply aligns its white dot with that of the base plate and turn clockwise.

- In addition to the standard (-1.5) diopter lens, there are 5 others: +1, 0, -1, -2, and -3.



Detaching the finder

While pressing the finder latch (A), as viewed from the front, slide the nameplate to the right, and while slightly raising the front remove the finder.



Attaching the finder

Insert the two prongs on the back of the finder into the slots on the camera body, and while pressing the front portion of the finder toward the camera body, return the nameplate to its original position. The latch will pop out and the finder will lock automatically.

6. Shutter Operation

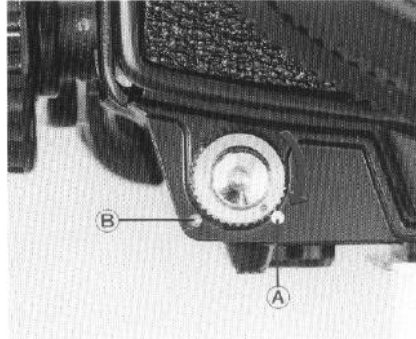

Shutter release button

The shutter release button incorporates a safety mechanism to prevent accidental release of the shutter.

When the shutter release locking ring is turned and the red index dot is aligned with the white dot (A) on the body, the shutter release button can be pressed.

When the red index dot is aligned with the red dot (B) on the body, the shutter release button cannot be pressed.

Releasing the shutter

When the shutter release button is pressed, the mirror is pushed up and the shutter is released.

- If the mirror is not cocked, the shutter release button cannot be depressed.
- The socket inside the shutter release button is threaded so that a cable release or a self-timer can be easily attached.

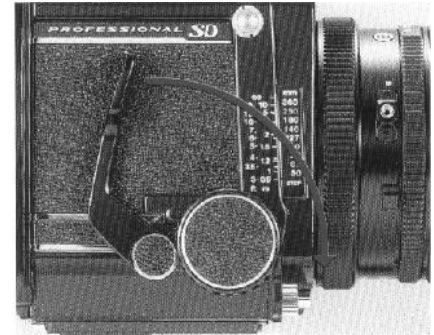

Cocking the shutter

Push the shutter cocking lever forward until it stops. The shutter in the mounted lens and the mirror in the camera body will be cocked simultaneously. The lever will return to its original position automatically.

- When the shutter is not completely cocked the shutter cocking lever will not return to its original position.
- Once the shutter is cocked, the cocking lever will not move until the shutter release button is pushed and the shutter released. Therefore, when the cocking lever does not move, it indicates the shutter is cocked.

7. Attaching and Detaching the Roll Film Holder

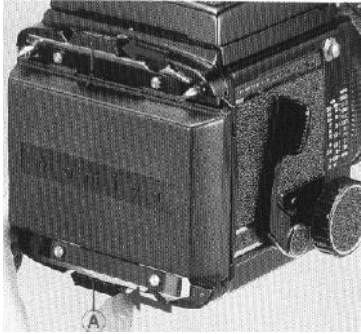

Removing the rear body cap

By moving the slide locks (A) on both sides all the way to the left, the cap be removed.

- Never push the light baffle on the camera back after removing the rear body cap. If the light baffle is forced, light leakage or other malfunctions may occur.

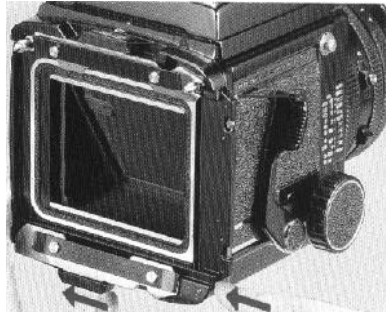

Attaching the roll film holder

1. Slide the upper and lower slide locks (A) on the back the body completely to the left of the indentation.

NOTE:

Should either slide lock be moved to the right while nothing is attached to the revolving adapter, the slide lock release lever (B) will engaged and the slide lock will not move. If this happens, press the release lever (B) and return the slide lock to the open position.

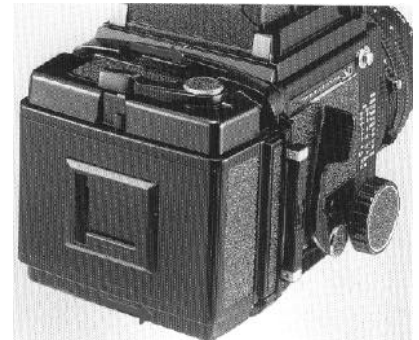

2. Attach the roll film holder to the body and slide both slide locks firmly in the direction of the arrow. (lock)

- If the revolving adapter slide lock is not completely pushed in or pulled out, the shutter safety lock will not release the shutter. Always make sure the slide lock is properly engaged or disengaged.
- The shutter release button can not be depressed if the dark slide is completely inserted or if there is no film in the camera. In addition the Pro-SD roll film coupler prevents multiple exposures. (See pages 16 and 25 for the shutter release test.)

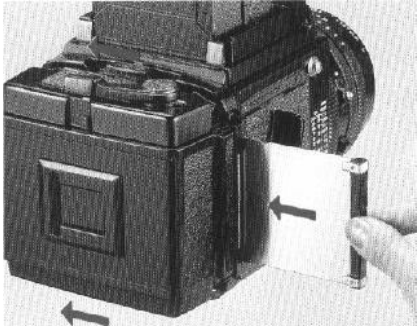

Removing the roll film holder

1. Insert a dark slide in the roll film holder.
 2. Remove the roll film holder by sliding both slide locks in the opposite direction to the arrow (Lock) on the slide lock.
- If the dark slide is not inserted, the slide lock will be locked by the safety device, and the roll film holder cannot be detached.
 - When a dark slide is completely inserted, the slide lock release lever is automatically disengaged, and the slide locks can be moved without pressing the release levers.

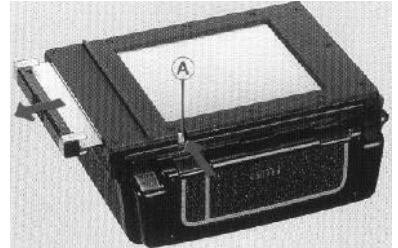

Extracting the dark slide of the roll film holder after it has been detached from the body

When the roll film holder for the Pro-SD[™] is removed from the body, the safety device prevents the dark slide from being pulled out carelessly or accidentally. However, if you desire to pull it out, simply use your fingernail tip to press the dark slide lock release lever (A) on the bottom of the outer cassette.

8. Releasing the Shutter

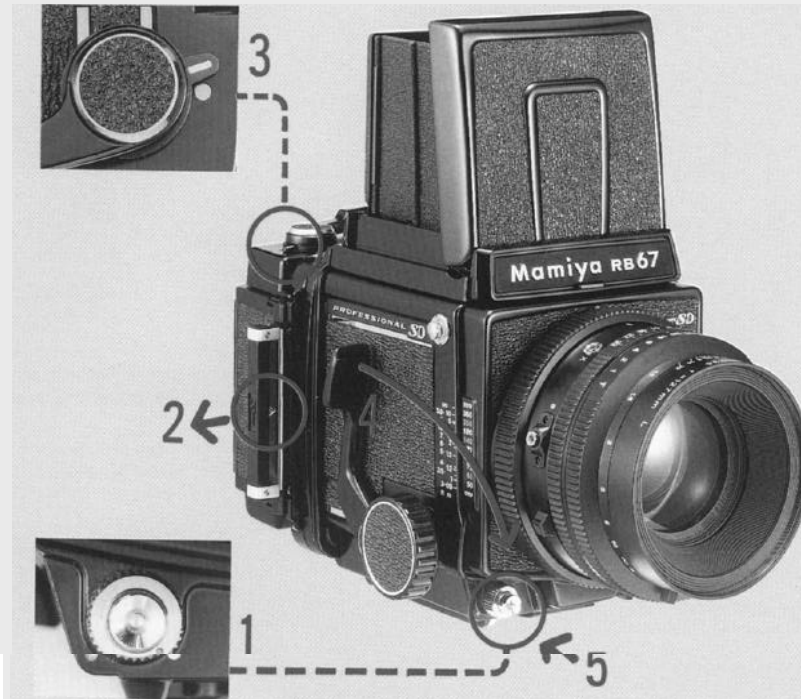

It is best to become acquainted with the method of releasing the shutter before actually putting film in the camera.

1. Rotate the shutter release lock ring until the mark on it is aligned with the white dot on the body.
2. Remove the dark slide or pull it out until all the triangular holes become visible.
3. Push the multiple exposure lever on the roll film holder forward to the multiple exposure position — i.e. until the red mark is visible.
4. Push the cocking lever all the way down.
5. Press the shutter release button.

The first steps can be done in any order. After you are thoroughly familiar with the above steps, return the multiple exposure lever to its normal setting.

9. Loading the Film Holder

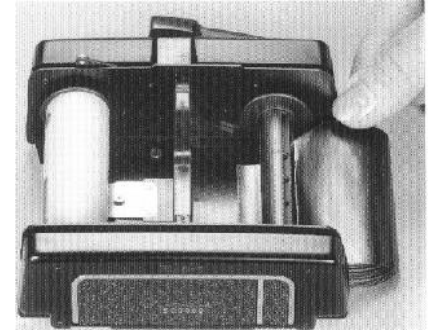
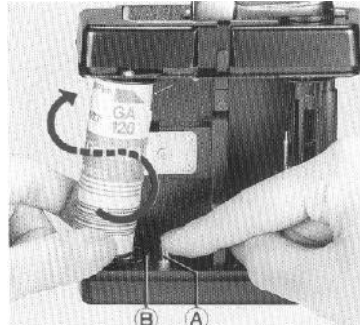
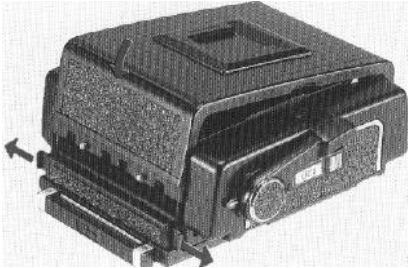

1. While pressing the back cover, pull out the upper and lower back cover latches and the back cover will open. Remove the film insert.
 - When loading film, avoid direct sunlight: either load the film in the shade or turn your body away from the sun and load it in the shade of your own body.
 - Use 120 roll film with the 120 roll film holder and 220 roll film with the 220 roll film holder.

2. While pressing the spool release pin (A) on the left side of the film insert, insert a new roll of film on the film spool stud.

Load the film so that the leader paper can be pulled out along the arrow of the leader paper guide mark (B). Wind the film with the printed side of the leader paper on the holder's pressure plate side. If the printed side does not face the pressure plate side, reload the film, reversing the film position.

3. Pull out the leader paper and insert the tip into the groove of the take-up spool.

* Position the film so that the leader paper winds evenly between the spool flanges-if it is uneven, film and photo malfunctions may occur.

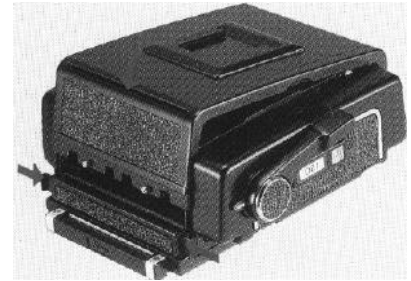
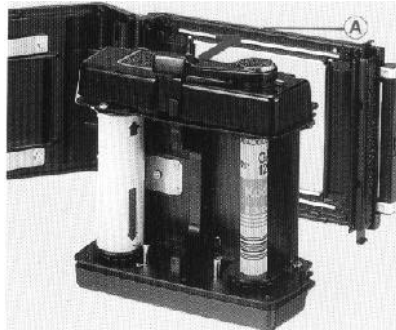
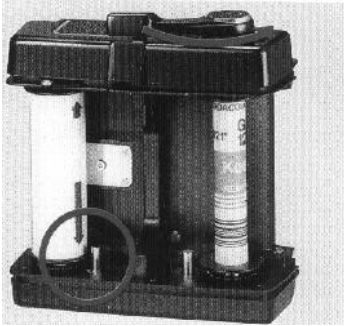

Move the film advance lever gently, until the starting mark (arrow) of the leader paper aligns with the starting mark of the holder. The film advance lever can be moved in several short, definite strokes.

- If the leader paper is pulled too far, the film may become fogged, so be careful not to go beyond the arrow.

1. Put the insert into the cassette, aligning the top side of the insert with the white dot (A) of the cassette.

- If the film insert is attached in reverse, the back cover cannot be closed.

2. While pressing the back cover gently, push the back cover latches (top and bottom) as far as they will go,

Setting Start Mark with 220 Roll Film

- To assure even frame spacing, and prevent overlapping, be sure to wind the film up to the printed arrow start mark, which appears after the dotted line.

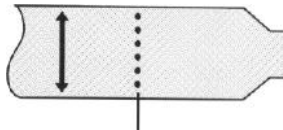

DO NOT use the dotted line for a start mark.

NOTE:

1. The outer cassette of the Pro-SD roll film holder (HA-701) can be used for both 120 and 220 film inserts.
2. The film insert of the Pro-SD roll film holder cannot to be attached to the outer cassette of the Pro-S roll film holder.

Exposure Counter

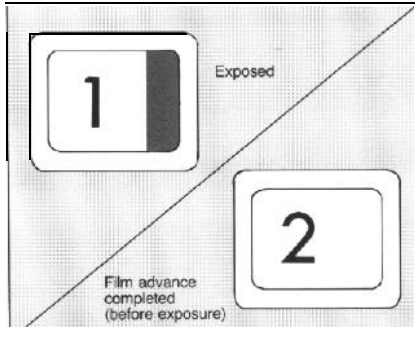
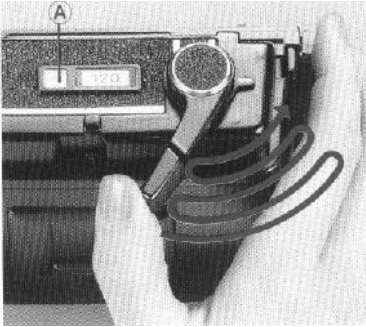

Film winding for first exposure

When the film is completely advanced, the numeral '1' will appear in the exposure counter and the red film-advance warning will disappear indicating that the holder is ready for photography.

- The shutter cannot be released unless the film from S (start) to 1 has been completely advanced with the cocking lever.

10. Operating the Revolving Adapter

(Changing the Picture Format to Horizontal or Vertical)

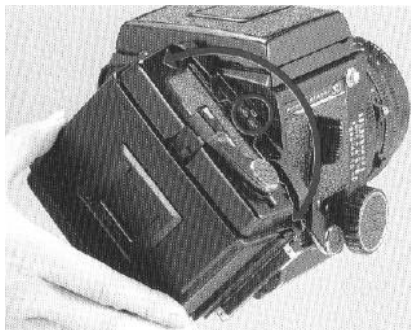

Operating the revolving adapter

When the horizontal format mark of the revolving adapter is facing upward, a horizontal photo will result. For a vertical photograph, turn the revolving adapter clockwise until it stops. To change from vertical to horizontal, turn the revolving adapter counterclockwise.

In either case, be sure to turn the adapter a full 90° until it clicks and stops. If the adapter is stopped midway, the shutter release button cannot be pressed.

- Do NOT turn the revolving adapter while the shutter release button is being pressed. Especially, when a cable release or a self-timer is used, and adjustment of the release tip is improper, the shutter release button will remain depressed after the shutter is released. Please note!

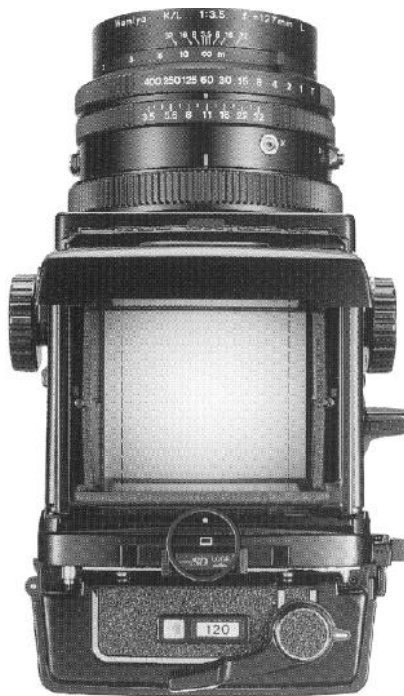

Horizontal picture format

When the revolving adapter is positioned for horizontal format photos, the solid red lines on the ground glass focusing screen indicate the limits of photo composition.



Vertical picture format

When the revolving adapter is positioned for vertical format photos, the broken red lines on the ground glass focusing screen indicate the limits of photo composition.

11 Setting the Shutter Speed and the Aperture

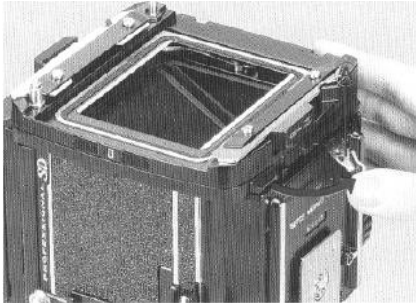

Removing/attaching the revolving adapter

To remove the revolving adapter, pull down the R-lock lever (A) on the back bottom of the camera.

To attach the revolving adapter, position the white dot on the side of the adapter towards the upper side of the camera, and completely push in the R-lock lever while firmly holding the adapter to the camera body.

- The revolving adapter for the Pro-S can also be used.
- **When attaching the revolving adapter, securely hold it to the camera body. A loose attachment may cause incorrect focusing or leakage of light.**



Setting the aperture

Turn the aperture ring until the desired aperture is aligned with the red dot on the center of the lens barrel.

- The fully automatic diaphragm can be easily stopped down.
- The aperture can be set at either full click stops or half graduated stops.

Setting the shutter speed

Align the desired shutter speed with the red dot on the center of the lens barrel.

- Always set the shutter speed to the click stop position: intermediate shutter speeds cannot be used.
- If the speed is changed, after cocking the shutter, do not turn the shutter speed ring rapidly.

12. Focusing and Focusing Knob Fixing

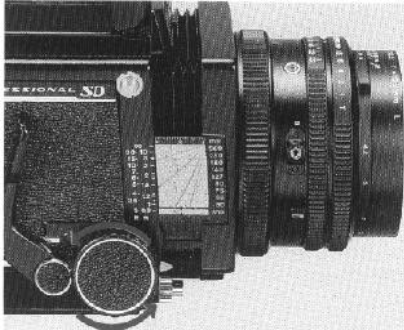

Focusing

When the shutter is cocked, the mirror is cocked simultaneously, and an image is visible on the ground glass focusing screen. By turning either the left or right focusing knob, adjust the focus and compose the picture.

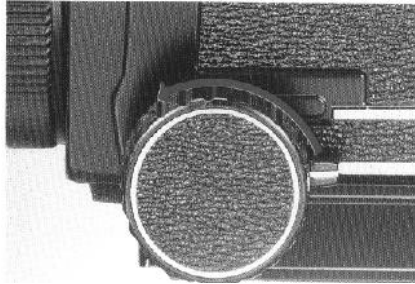

Focusing knob fixing

After adjusting the focus, turn the focusing knob fixing lever forward and clamp it to secure the focusing mechanism.

- Once secured deviations in focusing are prevented-ideal for conditions of continuous photo taking.

13. Taking Photographs

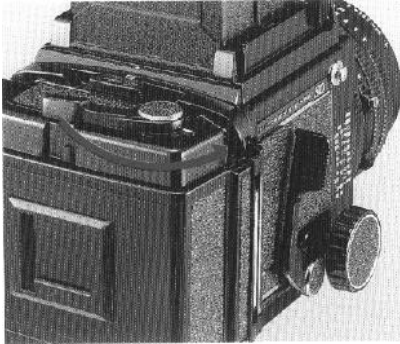

Advancing the film

1. Take out the dark slide and release the shutter. When the shutter is released, the red mark will appear in the exposure counter indicating that the film has been exposed.
2. As the shutter is released, simultaneously the film wind-stop mechanism is automatically disengaged, and the film can be advanced to the next frame. When film is advanced one full frame, the figure in the exposure counter advances and the red mark will disappear.

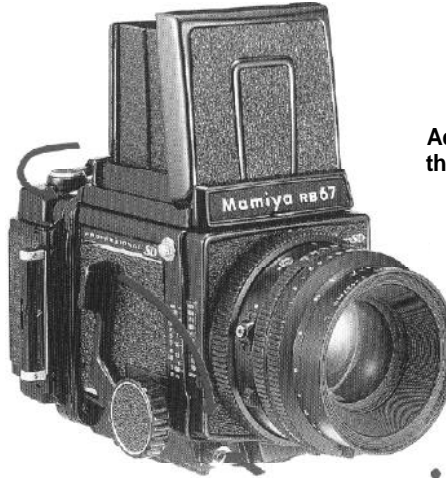

Advancing the film and cocking the shutter

- ① Film advancing
- ② Shutter cocking
- ③ Shutter releasing

However, either advancing the film or cocking the shutter can be conducted first.

- The multiple-exposure coupler will prevent shutter release unless the exposed film frame is advanced.
- A multiple-exposure photographic mode is an added feature.
- Wind the film advance lever in a slow, steady manner to avoid film advance problems.
- Although the film advance lever cannot be reversed until it is wound up to the initial 70° it can be moved in several short, definite strokes thereafter.

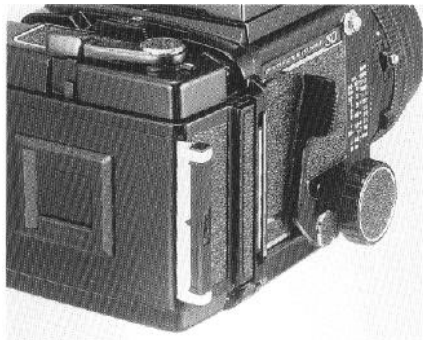

Storing the dark slide

When photographing, the dark slide may be conveniently kept in the storage on the back of the holder. It can be inserted either from the right or left side.

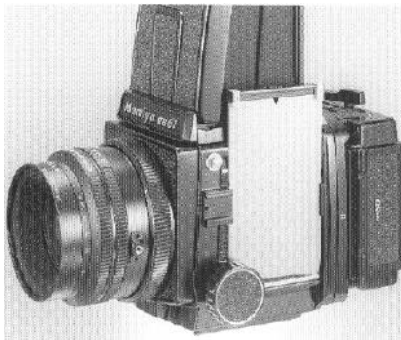

The dark slide can also be stored on the side of the camera body as pictured.

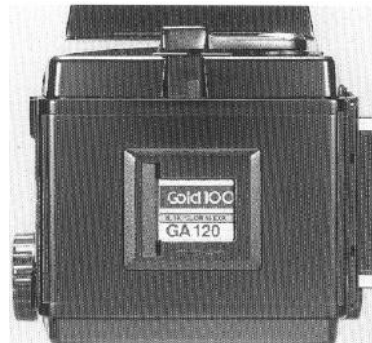

Memo clip

The clip on the back cover can be used for holding the cover of a film box or a slip of paper to record photographic data.

14. Testing the Shutter When the Film is Loaded

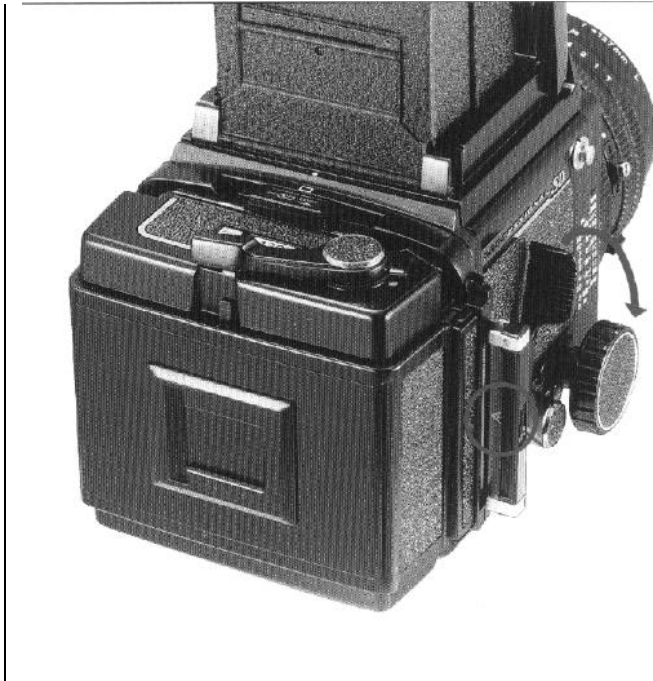

When the shutter is cocked with the darkslide partially pulled out (approx. 5mm) and the shutter release button is pressed, the shutter can be released without exposing the film in the roll film holder to light. This operation can be utilized for testing the shutter prior to photographing.

- When pulling out the dark slide, stop when the entire triangular hole on the dark slide becomes visible. If the shutter is released when the dark slide is pulled out beyond that hole, the film will be exposed to light.
- When the shutter is released, a red mark will appear on the exposure counter.
- When taking the first photograph subsequent to this test, cock the shutter in the multiple exposure mode (see page 32), and pull out the dark slide. After the first photo is taken, move the multiple exposure lever back to its normal position and continue photographing.

15. Unloading the Film

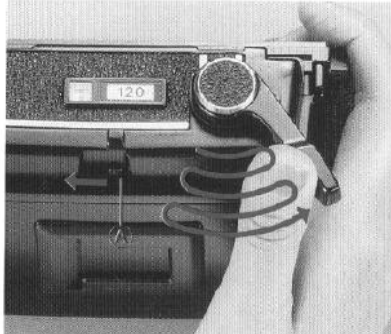

After completing the last exposure, completely wind the backing paper on to the take-up spool.

1. Open the back cover of the holder and remove the film insert. Press the right side spool release pin, remove the full spool, then wrap and seal the film to protect it from loosening.
2. Move the empty spool to the take-up side and the camera is ready for reloading.
 - The exposure counter automatically resets to S (start) as soon as the back cover is opened.
 - When the exposure counter shows other than S, film is in the holder. Be careful not to open the back cover in this mode!

Winding up film when unexposed frames remained in the holder

To wind up unexposed frames, push the film wind-stop release lever (A) to the left and continuously wind the advance lever until all the film is reeled up.

Handling of Exposed Film

- DO NOT remove exposed film from the camera under direct sunlight. Find a shaded area or turn your back to the sun and shade the camera before you open it.
- When removing the exposed film, be careful to prevent it from unraveling on the spool. Gently tighten the paper trailer, moisten the attached seal, and secure the film to prevent light leaks.
- Immediately place exposed film in your camera case or a bag, away from sunlight.

16. Distance Scale

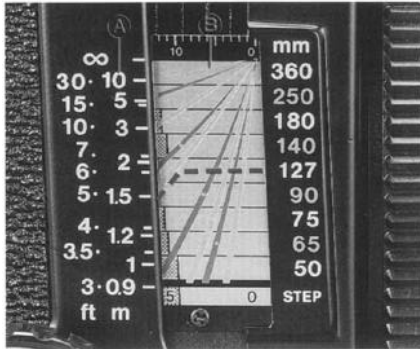

Distance from the film plane to the subject can be determined by the distance scale (A).

Each lens features different distance scale curves as pictured above. The figure on the distance graduation (B) which align with the curve indicates the distance to the subject.

For example, if the distance graduation and the curve are as shown in the photo after focusing with the 127mm lens, distance to the subject is 1.5m (5ft).

The curve for each lens is marked with a white dot. Since the dot coincides with the right-hand lens indicator, use it to quickly find the curve on the scale for the lens used.

17. Depth-of-field



The focusing screen

1. Set the desired aperture by turning the aperture scale ring and then adjust the focus.
2. Depress the depth-of-field preview lever (A) and the depth-of-field can be observed on the ground glass focusing screen.

Upon removing your finger, the lever will return to its original position and the lens aperture will fully reopen.



Using the depth-of-field scale

1. Turn the distance scale lever and align the figure representing the focused distance with the center index on the depth of field scale.
2. The two distances (on both sides of the center index) opposite the same figures as the actual lens aperture on the depth-of-field scale are the near and far limits of depth for a given distance and lens aperture.

For example, when photographing a subject 5 meters away with the 127mm lens at an aperture of $f/32$, objects from about 3 to 13m will be in focus.

18. Time (T) exposures, Flash Photography

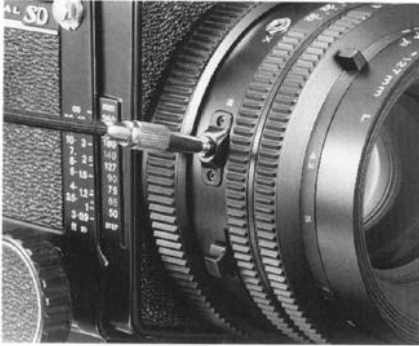

To make a time exposure, first set the shutter speed ring to T and screw a cable release into the bulb socket. After doing so, the shutter will remain open upon depressing the shutter release button.

The shutter will be closed by pressing the plunger of the cable release without giving any shock to the camera.

The shutter can also be closed by following procedures.



1. depressing the bulb socket by finger
2. turning the shutter speed ring toward 1 sec. (1)
3. pressing down on the shutter cocking lever about 30°

- Do not move the shutter cocking lever until just before closing the shutter.
- When the shutter is closed by the shutter cocking lever, the light baffle in the camera body drops down slightly; however no fogging occurs,

When the shutter is closed by the shutter cocking lever, the lever is locked by the reverse motion stopper and does not return to its original position. When the shutter is cocked by further depressing the lever, the lever returns to its original position.

19 Changing the Focusing Screen)

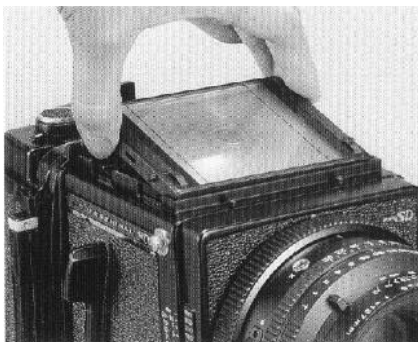
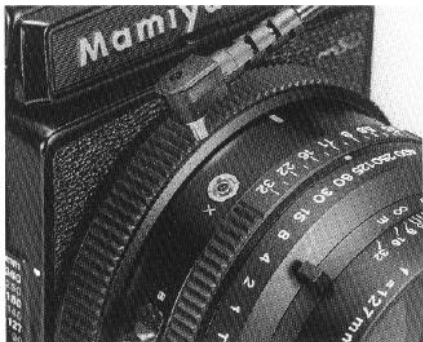

Flash photography

Connect the cord of the flash unit to the synchroflash terminal (X contact).

. The flash unit synchronizes at all shutter speeds.

Determining the aperture

The aperture setting for flash photography is determined by dividing the guide number of the flash unit by the subject distance.

For example, when photographed with ISO100 in m.

$$\frac{(\text{Guide number}) 40}{(\text{Subject distance}) 5 (\text{m})} = (\text{Correct aperture setting}) 8$$

Attaching and detaching

First remove the waist-level finder, then while holding both sides take out the focusing screen.

To attach it, hold each side and insert the focusing screen into the top of the camera body and press down lightly.

NOTE:

When the focusing screen has been detached, do not touch the picture format red rod indicator on the side of the camera body.

Seven types of interchangeable focusing screens are available to meet various photographic applications.

- The focusing screen is made of acrylic resin, and since its surface is soft and susceptible to damage, be carefully so as to not get fingerprints or other foreign matter on it.

When dust is wiped off with a cloth or lens paper, static electricity attracts more dust. So, use a blower brush to remove dust.

20. Mirror Lock-up Photography

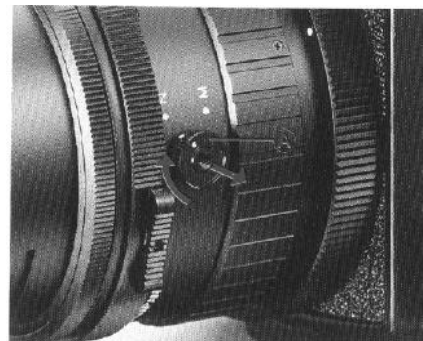
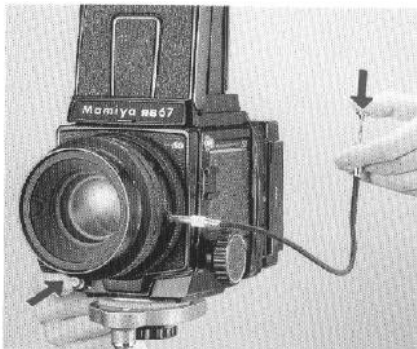
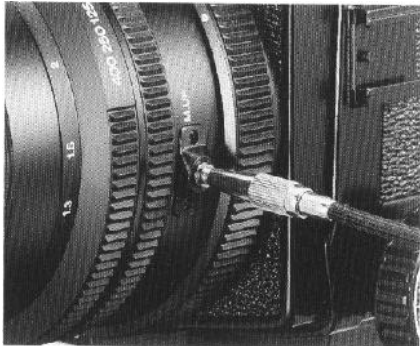

The mirror lock-up technique, whereby the mirror is raised beforehand and only the lens shutter is released is ideal for situations where vibrations must be completely eliminated. Specifically close-up photography, using telephoto lenses and in applications where long or slow exposures are necessary mirror lockup is ideal. With a tripod and cable release, the mirror lock-up mode ensures the utmost in sharpness.

Preparations

1. For mirror lock-up operation, securely screw a cable release into the lens socket as pictured. When the socket slightly elevates the camera will be in the mirror lock-up mode.

2. To cock the shutter and the mirror, press the cocking lever forward as far as it will go.

3. Upon depressing the shutter release button the mirror will rise, but the shutter will remain closed.

4. Press the plunger of the cable release and the shutter will operate.

NOTE:

- Unless the cable release is removed from the mirror lock-up socket, the camera will remain in the mirror lock-up mode and the film

cannot be exposed even when the shutter release button is pressed.

When mirror lock-up photography is completed, be sure to remove the cable release. If the red line around the mirror lock-up socket is still visible, when the cable release is removed, the camera is still in the mirror lock-up mode. So, be sure that the cable socket sinks and the red line disappears.

- As shown in the photo, some lenses use a mirror release operating knob. When using a lens with a knob, pull out the mirror release operating knob (A), turn it clockwise, and screw the cable release into the knob aligning the red dot on the knob with the MIRROR LOCK-UP indicator.

When mirror lock-up photography is completed, be sure to remove the cable release and return the knob to its original position.

Using the Mirror Lock-up Cable Release

1. When exposure is shorter than 1 second:

(1) Screw the short cable into the mirror lock-up socket, and screw the long cable into the shutter release button.

(2) By pressing the cocking lever forward as far as it will go, cock the shutter and the mirror.

(3) The first stroke will make the mirror rise, and the second will release the set speed.

*For lenses which use the mirror lock-up operating knob, align the knob with the MIRROR LOCK-UP indicator, screw in the short cable, and screw the long cable into the shutter button. The first stroke will make the mirror rise, and the second will release the set speed.

2. When exposure is longer than 1 second, it is convenient to integrate with time(T):

(1) Screw the short mirror release cable into the bulb unit of the lens, and screw the long cable into the mirror lock-up socket.

(2) Set the shutter speed ring to T.

(3) Raise the mirror by pressing the shutter release button on the body.

(4) The first stroke of the mirror release will open the shutter and the second stroke of the mirror release will close it.



21 Multiple Exposure Photography



When the multiple exposure lever of the roll film holder is moved forward, the multiple-exposure prevention coupling pin disengages. In this mode the shutter can be cocked and released without limit.

- The multiple exposure lever can be changed over before or after the shutter is cocked, and also before or after the shutter is released for the first multiple exposure photograph.
- When the multiple exposures are completed, never fail to return the multiple exposure lever to its original position; otherwise, subsequent photos will also be multiple exposures.

22 Close-up Photography

Exposure compensation for close-up photography

When the bellows of the camera is extended for close-up photography, and distance between the lens and the film plane increases, image brightness on the film plane decreases, thus requiring an increase in exposure. To adjust the exposure, refer to the exposure compensation scale on the camera body.

When a finder with built-in exposure meter (i.e. PD Prism Finder or PD Magnifying Hood) is used, exposure compensation is unnecessary, since TTL metering takes place.

When making exposure compensation, refer to the exposure compensation scale on the camera body.

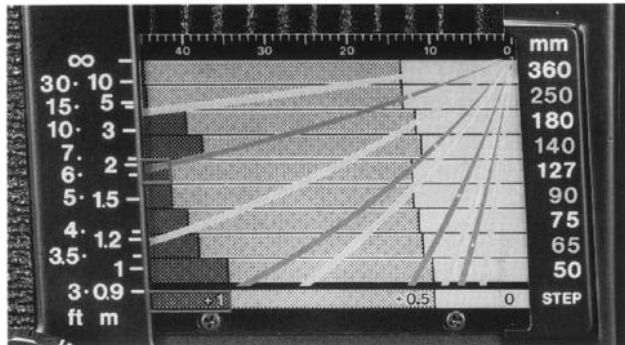

Maximum close-up photography table with belows fully extended.

Lens	Lens-to-subject distance	Magnification	Subject size
Sekor C 50mmf/4.5	49mm	0.88	63× 79mm
KL 65mmf/4	85mm	0.70	80×100mm
KL 75mmf/3.5	125mm	0.61	92×114mm
KL 90mmf/3.5	196mm	0.51	111×138mm
KL127mmf/3.5	408mm	0.36	155×192mm
Macro KL140mmf/4.5	512mm	0.33	173×214mm
KL180mmf/4.5	830mm	0.26	217×270mm
KL250mmf/4.5	1578mm	0.19	299×371mm
KL360mmf/6	3378mm	0.13	432×536mm

1. After focusing the lens, read the exposure compensation factor on the scale.

For example, assuming that the focus was adjusted with the 127mm lens, the result will be as shown in photo above.

Look for the same pattern in the bottom column where the side panel lines meet the 127mm lens scale. The numerical value of that pattern (+1 in this case) is the exposure compensation value.

2. Change either the shutter speed or the aperture for exposure compensation.

When the exposure compensation value is +1, open the aperture one step, or slow the shutter speed 1 step. For a 0.5 step compensation, use the half-stop aperture scale settings.

For example, if your exposure meter shows an exposure setting of (1/60 sec. at f/16), it must be adjusted in the case of the +1 compensation value to (1/30 sec. at f/16) or (1/60 sec. at f/11).

- When using the 50mm and 65mm lenses closer than 1 meter (3¼ft), it is necessary to use a lens aperture of f/16 or smaller to obtain satisfactory lens performance.
- Graduations on the upper side of the distance scale represents the belows extension values (mm).
This scale is used to obtain exposure compensation values for close-up photography with extension tubes.

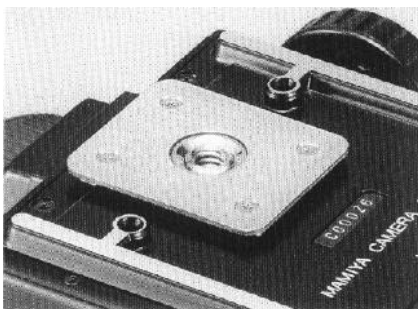

Lens hood

The lens hood attached to the standard 127mm lens can be used for the 90mm lens.

- Screw the attachment ring into the front of the lens mount.
- Pull the folded rubber hood straight out.
- The lens hood may be left on when the camera is being carried — simply push back and turn out the hood while it is attached to the lens.
- A filter can be screwed in between the lens and the hood, or in front of the lens hood.

Using a tripod

The use of a large, sturdy tripod is recommended for optimum picture quality.

1. The standard tripod has a 1/4 inch tripod screw. Simply attach the RB67 Pro-SD as you would any other camera with standard threads.

2. When using a tripod with a 3/8 inch screw, first remove the small screw in the base of the tripod socket by turning it counterclockwise with a coin or an appropriately sized screw driver. Next, remove the 1/4 inch adapter (A) from the tripod socket by rotating it counterclockwise. The camera can then be mounted on a 3/8 inch screw tripod.



Used on 50mm and 65mm lenses (80mmø slip-on type)



Used on 90mm, and 127mm lenses (77mmø screw-in type)



Used on 140mm, 150mm, 180mm, 210mm, 250mm, and 350mm lenses (77mmø, screw-in type)



For the 500mm lens (108mmø)



For the 75mm lens f/3.5 lens (80mmø, slip-on type)



For the 100-200mm zoom lens (60mmø, slip-on type)

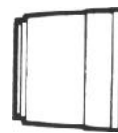

For the 360mm lens (77mmø, screw-in type)

23 How to use the Carrying Strap

Attaching the Strap

Hold the metal clamp of the strap so that the key-hole shaped opening faces the Carrying Strap Lug on the camera body. Gently fit the upper part of the key-hole opening over the lug. Next, gently push the bottom of the metal clamp upwards and it will lock in place with a click.

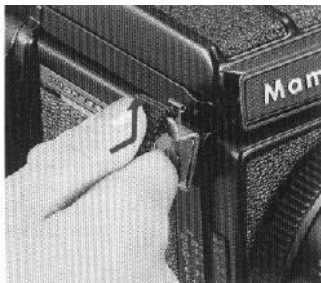

If the clamp is attached to Accessory-shoe side of the camera upside-down, it will be difficult to remove, so be careful to attach the clamp rightside-up.

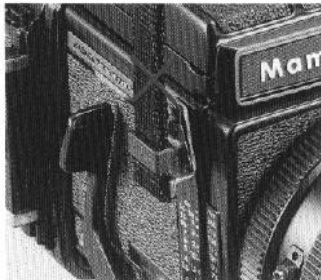

Removing the Strap

Reach behind the strap and while gently squeezing the top of the protruding front plate (leaf spring), slide the clamp downward and off the lug.

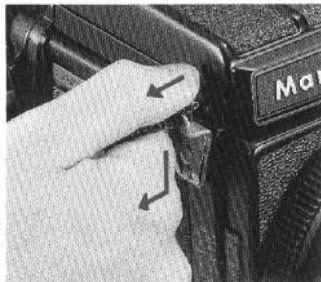

Three Carrying Positions

Depending upon the way the strap is attached to the camera, there are three ways of carrying the camera as shown in the accompanying illustrations. Since the Carrying Strap Lug is not rotary, the carrying strap will not become twisted.

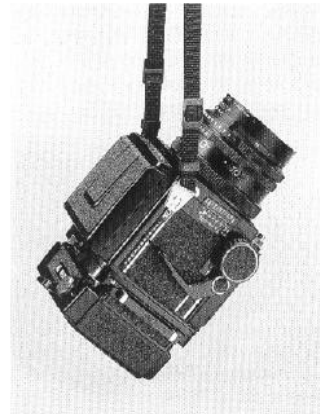

24 Back Locking System

The unique back locking system of the Mamiya Pro-SD is designed to allow it to accept a large variety of film holders. All Pro-SD seies film holders mount and lock directly on the back of the Pro-SD.

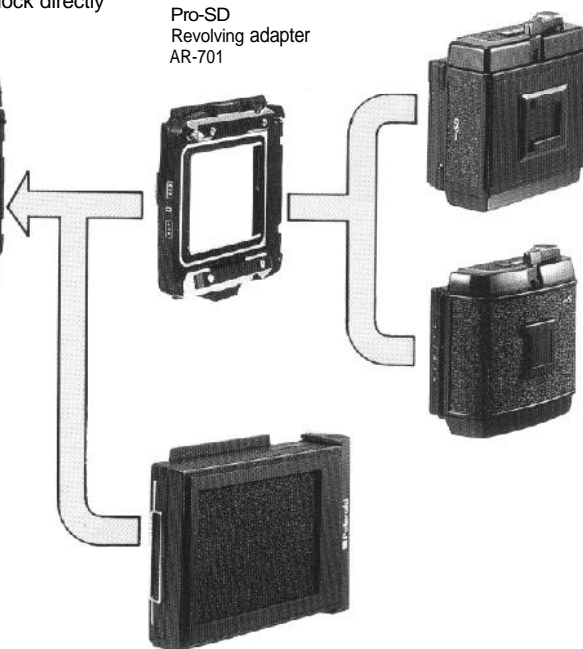

Pro-SD
Revolving adapter
AR-701

Pro-SD
120 Roll film holder HA-701
220 Roll film holder HB-701
6x4.5 Film holder HA-702 (exclusively for 120):
to be released soon.
6x4.5 Film holder HE-704 (exclusively for 220):
to be released soon.





RB
Pro-S 120 Roll film holder
Pro-S 220 Roll film holder
120/220 Power drive roll film holder 6x8
120/220 Power drive roll film holder 6x7
6x4.5 Film holder (exclusive for 120)
Double cut film/plate holder
70mm Film holder

Pro-SD
Polaroid pack film holder
HP-701

25 Lens Mount Adapter Ring

When using Mamiya Sekor C interchangeable lenses with the RB67 Pro-SD, the lens mount adapter ring must be used. It should be attached to the rear lens mount. (When using Mamiya KL lenses with the RB Pro-S and RB67, remove the lens mount adapter ring.)

- The lens mount adapter ring comes with Sekor C lenses.
- For KL lenses it is attached to the rear lens mount.
- Both the 75mm shift and APO 500mm lenses are L lenses.
- Make sure to securely tighten the lens mount adapter ring onto the lens mount.





Body \ Lens	Sekor C	KL	L
RB67 Pro-SD	The lens mount adapter ring should be attached.		
RB67 Pro-S		The lens mount adapter ring should be detached.	

Mamiya RB67 Pro-SD Operation Diagram

Attaching a lens with the shutter released or the mirror raised

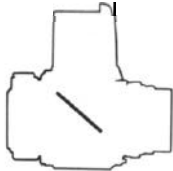
When a lens is removed from the body, the mirror is set (lowered) and the lens shutter cocked. Conversely, when attaching a lens, the same conditions should prevail (mirror set and shutter cocked). However, should a lens be attached with either the mirror raised or shutter released, or both, the camera can be reset by following the procedures outlined below.

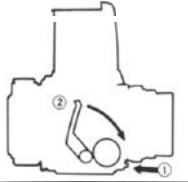
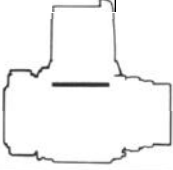
1. If the mirror is raised (regardless of whether the lens shutter is cocked or released), simply depress the Cocking Lever to reset the camera.
2. If the mirror is set and lens shutter released (closed), remove the Dark Slide from the Film Holder and depress the Shutter Release Button (the film will not be exposed). Next, depress the Cocking Lever to reset the camera.

	Mirror condition	Shutter blade condition	Operation
1		 Closed	
2		 Opened or Closed	

1 Shutter setting mode

Shutter blade



Aperture blade

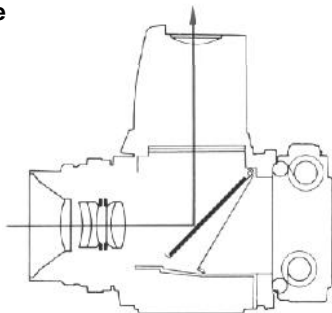

- Both the shutter blade and the aperture blade are opened.
- The mirror and the light baffle are lowered to the set position.

2 Just after pressing the shutter release

Shutter blade



Aperture blade

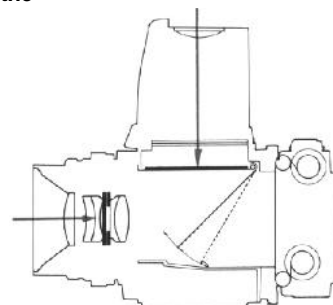

- The Shutter blade is closed and the aperture blade begins stopping down.
- The mirror is raised and the light baffle starts rising.

Mirror-up photography

Shutter blade

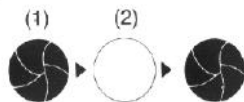

Aperture blade

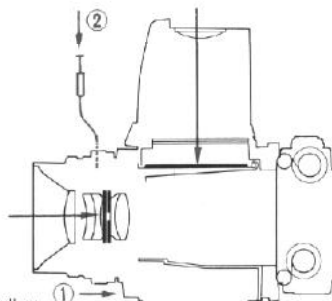

- (1) When pressing the shutter release button:
- The shutter blade is closed and the aperture blade stops down to a preselected aperture.
 - The mirror and the light baffle are raised.
- (2) When releasing the shutter, using the mirror-up release:
- Only the shutter blade operates, closing after being fully opened.

3 Exposure

Shutter blade



Aperture blade

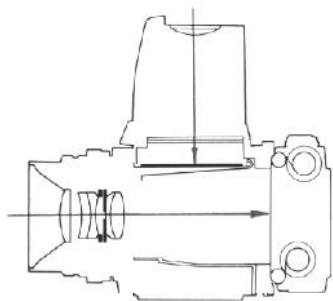

- The light baffle is raised to its limit.
- The aperture blade stops down to a preselected value.
- The shutter blade is closed after being fully opened.

26 Trouble Shooting

Various safety interlocking devices are incorporated in the Mamiya RB67 Pro-SD to eliminate careless operational mistakes. When the shutter is not released, or when the lens or the roll film holder cannot be removed, do not hastily conclude that this indicates a camera malfunction. Check the following conditions: the numbers in parentheses indicate the page number in the Instruction Manual that cover relevant malfunctions.

Shutter release button cannot be depressed

1. Is the shutter release button locked?

Turn the shutter release lock ring counterclockwise and align it with the white dot. (p.13)

2. Is the mirror set?

Set the mirror by pressing the shutter cocking lever down.

3. Is the roll film holder loaded with film and has the film been advanced to the first exposure?

4. After the shutter was released during ordinary exposure (not during multiple exposures), did you advance the film?

5. Was the dark slide pulled out?

Pull out the dark slide.

6. Is the revolving adapter turned to the click stop position?

Turn the adapter until it stops with a click. (p. 20)

7. Has the slide lock on the revolving adapter stopped halfway?

Move the slide lock until it stops. (p.4)

Lens cannot be removed

To remove, press the shutter cocking lever down. Set the mirror and the shutter. (p.10)

When mounting the film holder, won't the slide lock move?

While pressing the side lock release lever, move the slide lock to the left. (p. 14)

Can't the roll film holder be removed?

After inserting the dark slide, the slide lock should operate.

27 Camera Storage and Maintenance

- If the camera is not to be used for a long time, remove the film.
- Do not store the camera at temperature exceeding 40°C or below -10°C. Also avoid storing in a damp or a sea air environment.
- As your camera is a precision instrument, avoid exposing it to vibrations or severe shocks. When handholding your camera, always exercise extreme caution so that it is not dropped or hit against something.
- Prolonged disuse does not lengthen camera life, but shortens it. So, when storing it for a long time, periodically take the camera out and release the shutter several times to keep it in good condition.

When using the RB67 Pro-SD for important photos for on location photography, weddings, overseas trips and or other important photography, be sure to take some trial photos and check all functions.

It is advisable to put your camera in for periodic check-ups (at intervals of one to two years) to thus ensuring the best photography at optimum performance.

Cleaning

- Never touch the surface of the mirror! If it needs cleaning, use a blower brush or lens paper to gently remove dust particles. Please note the surface should never be touched!
- Do not touch the lens surface. If a fingerprint gets on the surface, first remove the dust particles with a blower brush. Then gently wipe the fingerprint off with a lens cleaning paper with a drop of lens cleaner on it: finally, gently wipe dry with dry lens paper.

Periodic Check

Periodically check the camera to make sure it is in working order. This is especially important before beginning a photographic session or assignment. Check the battery, flash synchronization, mirror and shutter operation, diaphragm functioning and film advance. Also check any accessories you plan to use.

For a general overhaul, cleaning, or minor repair, take the camera to your nearest authorized Mamiya Service Center or see your camera shop for advice.